

LEAK

User Manual



CDT

CD PLAYER WITH USB

LEAK'CDT'
CD PLAYER WITH USB

I N S T A L L A T I O N - O P E R A T I O N - M A I N T E N A N C E

Important Safety Information



This lightning flash with arrowhead symbol within an equilateral triangle is intended to alert the user to the presence of non-insulated "dangerous voltage" within the product's enclosure that may be of sufficient magnitude to constitute a risk of electric shock.

Warning: To reduce the risk of electric shock, do not remove cover (or back) as there are no user-serviceable parts inside. Refer servicing to qualified personnel.

The exclamation point within an equilateral triangle is intended to alert the user to the presence of important operating and maintenance instructions in the literature accompanying the appliance.

Read these instructions.

Keep these instructions.

Heed all warnings.

Follow all instructions.

Do not use this apparatus near water.

Clean only with dry cloth.

Do not block any ventilation openings. Install in accordance with the manufacturer's instructions.

Do not install near any heat sources such as radiators, heat registers, stoves, or other apparatus (including amplifiers) that produce heat.

Do not defeat the safety purpose of the polarized or grounding-type plug. A polarized plug has two blades with one wider than the other. A grounding plug has two blades and a third grounding prong. The wide blade or the third prong is provided for your safety. If the provided plug does not fit into your outlet, consult an electrician for replacement of the obsolete outlet.

Protect the power cord from being stepped on or pinched, particularly at the plugs, convenience receptacles, and at the point where they exit from the apparatus.

Unplug this apparatus during lightning storms or when unused for long periods of time.

Refer all servicing to qualified service personnel. Servicing is required when the apparatus has been damaged in any way, such as power supply cord or plug is damaged, liquid has been spilled or objects have fallen into the apparatus, the apparatus has been exposed to rain or moisture, does not operate normally, or has been dropped.

CAUTION: These servicing instructions are for use by qualified service personnel only. To reduce the risk of electric shock, do not perform any servicing other than that contained in the operating instructions unless you are qualified to do so.

Do not install this equipment in a confined or built-in space such as a bookcase or similar unit, and keep well ventilated in open space. The ventilation should not be impeded by covering the ventilation openings with items such as newspaper, table-cloths, curtains etc.

WARNING: Only use attachments/accessories specified or provided by the manufacturer (such as the exclusive supply adapter, battery etc).

WARNING: Please refer to the information on the exterior panel of the enclosure for electrical and safety information before installing or operating the apparatus.

WARNING: To reduce the risk of fire or electric shock, do not expose this apparatus to rain or moisture. The apparatus shall not be exposed to dripping or splashing and that objects filled with liquids, such as vases, shall not be placed on apparatus.

WARNING: For the terminals marked with symbol of "⚡" may be of sufficient magnitude to constitute a risk of electric shock. The external wiring connected to the terminals requires installation by an instructed person or the used of ready-made leads or cords.



Protective earthing terminal. The apparatus should be connected to a mains socket outlet with a protective earthing connection.

The product is designed to use in moderate/ tropical climates.

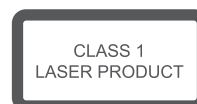

This label tells you that the unit contains a laser component. Opening the unit will expose the user to radiation from the laser beam.

The apparatus with CLASS I construction shall be connected to a MAINS socket outlet with a protective earthing connection.

Mains Supply: The mains operating voltage of the LEAK CDT is shown on the rear panel. If this voltage does not match the mains voltage in your area, consult your LEAK dealer about converting the unit.

The mains supply fuse on the rear panel is accessible when the IEC mains plug has been removed. In the rare event that it has broken, check for any obvious cause before replacing the fuse with one of the correct rating and type.

WARNING: No naked flame sources, such as lighted candles, should be placed on the apparatus.

WARNING: Attention should be drawn to environmental aspects of battery disposal.

WARNING: Use of the apparatus in tropical climates.

THE FUSE VALUES ARE:

220 – 240V (UK, China, etc.) T630mA 250V Slow Blow

100 – 120V (USA, Japan, etc.) T1A 250V Slow Blow



'CDT'
CD PLAYER WITH USB

INSTALLATION - OPERATION - MAINTENANCE

Contents

GETTING STARTED 4

CONTROLS AND CONNECTORS 5

REMOTE HANDSET 6

CONNECTION 7

OPERATION-1 8

OPERATION-2 9

WARRANTY 10

SPECIFICATIONS 11



LEAK'CDT'
CD PLAYER WITH USB

I N S T A L L A T I O N - O P E R A T I O N - M A I N T E N A N C E

Getting Started

INTRODUCTION

The LEAK CDT is a high-performance CD player with USB storage device playback functionality.

To ensure proper operation, please read this owner's manual carefully before using the product. After reading this manual, be sure to keep it for future reference.

FEATURES

- CD/CD-R/CD-RW compatibility
- USB memory storage device playback (MP3/WMA/AAC/WAV)
- Display on/off options
- Automatic equipment activation via 12V trigger output
- Auto standby function with function on/off option

UNPACKING THE EQUIPMENT

Unpack the product fully. The carton should contain:

- The LEAK CDT player
- One IEC power cord suitable for your area
- One remote handset
- The LEAK CDT user manual

Consult the dealer from whom you purchased the equipment if any item is not present.

Carefully unpack the unit and accessories. Take care not to damage the surface finish when undoing the protective polythene sleeve. Retain the packing materials for future use. Retain the user manual and information concerning the date and place of purchase of your equipment for future reference. If you transfer the unit to a third party please pass on this instruction manual along with the equipment.

Note: The LEAK CDT should be used with the DIGI or OPT outputs connected directly to a preamplifier with inbuilt DAC. Compatible with 120mm (4.73-inch) CDs only.

PLACEMENT

The unit must be mounted on a solid, level and stable surface.

Before you connect the LEAK CDT to the AC mains power, ensure your AC mains voltage corresponds to the rating on the rear panel of the product. If in doubt, consult your dealer. If you move to an area which has a different mains voltage, seek advice from a LEAK appointed dealer or a competent service technician.



'CDT'
CD PLAYER WITH USB

INSTALLATION - OPERATION - MAINTENANCE

Controls and Connectors

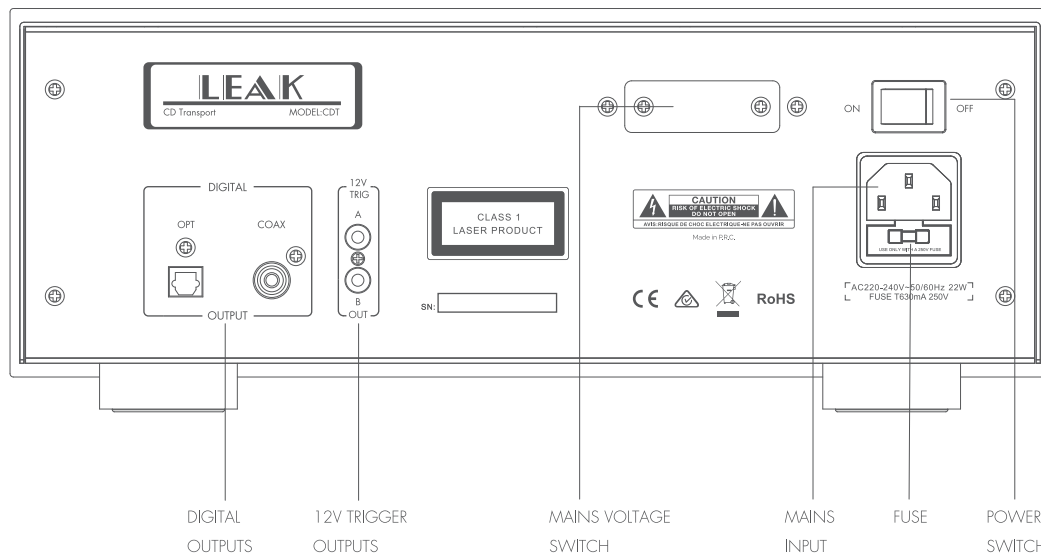
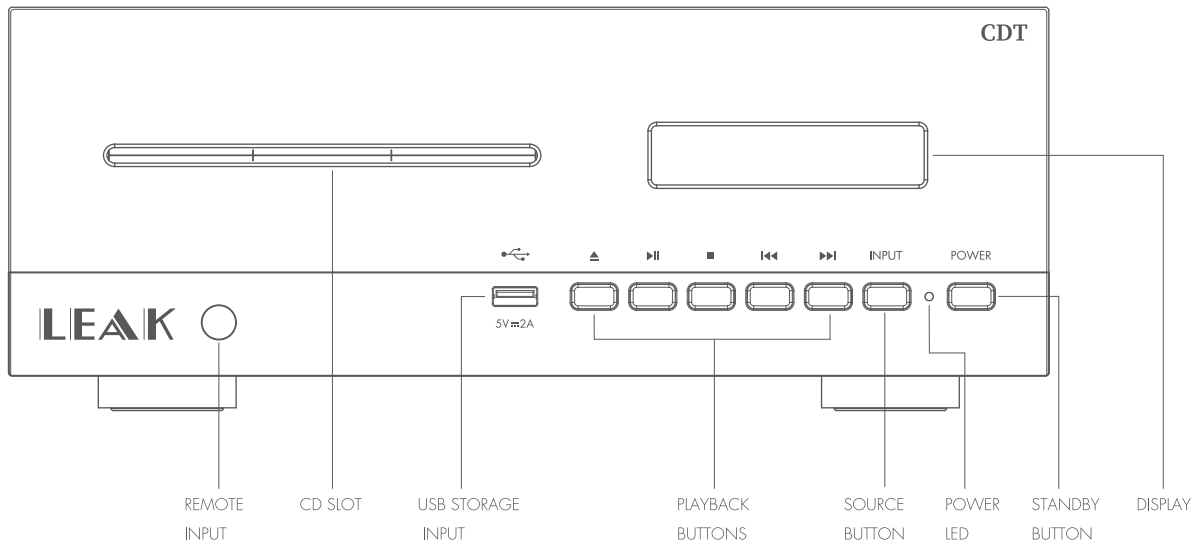

Remote Handset

NOTE : the handset buttons shown crossed out are for use with other LEAK units such as the LEAK Stereo 130 and are therefore not functional when used with the LEAK CDT

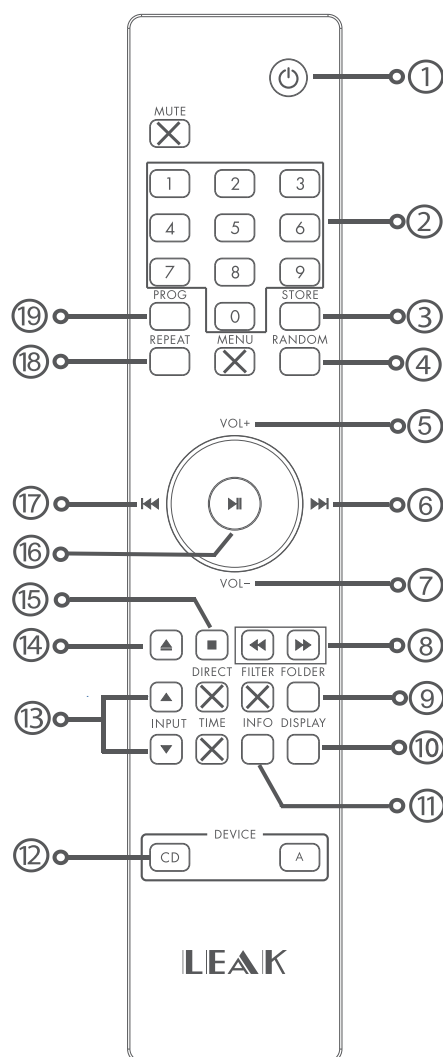

- | | | |
|----|-------------|---|
| 1 | STANDBY | Press to bring the unit in/out of Standby |
| 2 | Number Keys | Press to go directly to a track by number (CD play mode) |
| 3 | STORE | Press to store a track in Program mode (CD play mode) |
| 4 | RANDOM | Press to select random mode |
| 5 | VOL+ | Choose files upward (USB play mode) |
| 6 | ▶▶ | Press once to move to the next track. Choose files downward (USB play mode) |
| 7 | VOL- | Choose files downward (USB play mode) |
| 8 | ◀◀ ▶▶ | Press and hold to fast reverse/fast forward search |
| 9 | FOLDER | In the list interface: briefly press to return to previous folder; long press to return to top folder
In the playing interface: long press to switch between "F" (Folder) or "A" (All) mode (USB play mode , see page 9) |
| 10 | DISPLAY | Press to alter the display ON/OFF |
| 11 | INFO | Song information display, switch between title name, artist name, album name, song genre and home interface (USB play mode only) |
| 12 | CD | Press to select the LEAK CDT remote mode (press the A button for Stereo 130 controls) |
| 13 | INPUT | Press to switch between CD/USB playback |
| 14 | ▲ | Press to eject/load the disc |
| 15 | ■ | Press to stop CD playback
In the programming playback mode, press twice to exit the programming mode (CD play mode) |
| 16 | ▶ | Play/Pause (CD/USB play mode) Enter to files (USB play mode) |
| 17 | ◀◀ | Press once to replay the current track. Press again to skip back to the previous track.(CD play mode)
Press once to skip back to the previous track. Choose files upward (USB play mode) |
| 18 | REPEAT | Press to select a repeat mode (switch between single repeat, whole track repeat and sequence) |
| 19 | PROG | Press to program tracks of your choice when not in Play mode (CD play mode) |

NOTE:

Always use AAA batteries and replace them in sets - never mix old and new batteries.

Very weak batteries can leak and damage the handset. Replace them in good time! There is a risk of fire and burns if a battery is handled improperly. Do not disassemble, crush, puncture, short the contacts or dispose of the batteries in fire or water.

Do not attempt to open or service a battery. Discard used batteries in full accordance with recycling regulations in force in your area.

Connection

DIGITAL, COAXIAL AND OPTICAL OUTPUTS

The LEAK CDT has one coaxial and one optical SPDIF digital output. Connect a suitable digital coaxial (fully screened) interconnect or optical cable from the appropriate SPDIF output of the LEAK CDT to the input of a DAC or digital input on your amplifier or preamplifier, as per the example illustrated below.

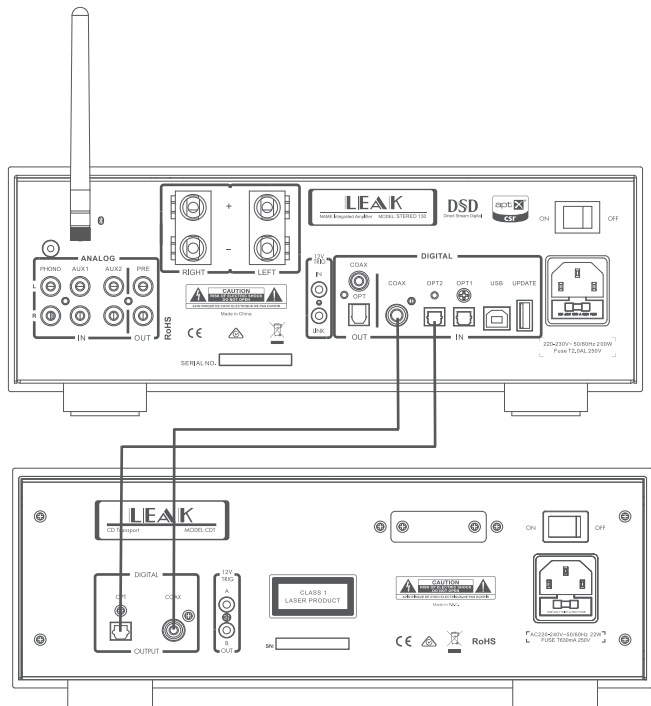

TRIGGER CONNECTIONS

The LEAK CDT back panel has a pair of standard 12V trigger output connectors which can connect to LEAK STEREO 130, or 12V trigger input connector of any other audio device. This will enable universal control for power-on/ power-off of the Trigger connected devices. A 3.5mm audio cable should be used to connect the 12v trigger devices (master and slave).

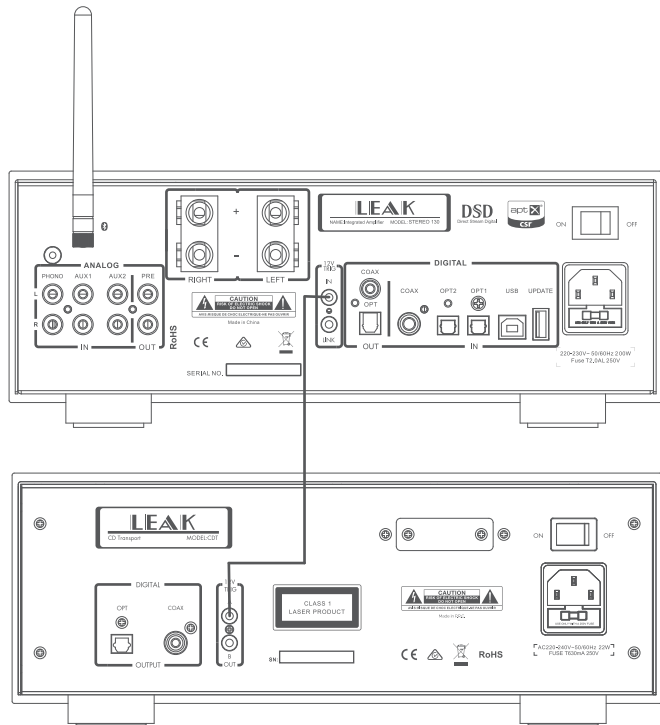

Operation-1

SWITCHING ON AND OFF

Connect the mains lead plug to the mains socket and then turn on the rear power switch. The CDT will power-on in the standby state. The red power indicator on the front panel will be illuminated.

STANDBY MODE

To exit the standby mode, press the  button of the LEAK CDT remote control or press the power button on the front panel of the CDT. The front panel display will show the LEAK CDT welcome screen.

You can activate the 'auto standby' function by holding down the POWER button on the front panel for a few seconds, then select the function you want, from the list below, with a short press of the POWER button.

Standby 20Min (Default)

The Standby indicator flashes twice: Auto-Standby after 20 minutes of inactivity. The LEAK CDT will automatically go into Standby mode if there is no signal input or operation for 20 minutes.

Standby 1 HOUR

The Standby indicator flashes three times. Auto-Standby after 1 hour of inactivity. The LEAK CDT will automatically go into Standby mode if there is no signal input or operation for 1 hour.

Standby Never

The Standby indicator flashes once: Auto-Standby Never. The LEAK CDT will not go into Standby mode.

CHOOSE MEDIA PLAYBACK MODE

Press the INPUT button on the remote control or the CDT front panel to choose which media to play.

Disc: Choose to play a compact disc. ('No Disc' will show when drawer is empty)

USB: Choose to play from a USB memory device ("No Drive" will be shown if a USB memory device is not connected.)

CD PLAYBACK

Insert a disc into the CD slot. Disc information will be shown after the disc is read.

Press remote control or front panel  button to eject the disc.

 Play/Pause

 Previous/Next song; Repeat play of the existing track by pressing the Previous button once. Play the previous track by pressing twice.

 Press and hold to fast reverse/fast forward search

 Stop playing

Direct selection of the tracks from the remote control

Select your desired track number directly from the remote key pad. The disc will play forward from the chosen track. If you choose a single-digit track (e.g. 1) in a disc which contains more than 10 tracks, the player will pause briefly, waiting for you to enter a second digit. If none is entered, play will commence from the entered single-digit track. If the choice is invalid the display reverts to the previous state.

REPEAT PLAY

Press the Repeat key on the handset to repeat single track or all the tracks on the disc continuously.

RANDOM PLAY

Press the remote control RANDOM button to choose random playback of all tracks.

PROGRAMMING PLAYBACK

Set a custom programmed playback track order. Programming mode can only be utilised when the CD is not playing.

First, enter the programming mode by pressing the remote control PROG button. Navigate to the desired track, then press STORE to save the selected track. Repeat this process with your next desired tracks to complete your programmed playback order.

Press  button to play the programmed track.

Press  button to stop playing the programmed track. Once your programmed playback order is finished, the LEAK CDT will stop. Press the stop button twice or press the RANDOM button to exit programming mode.

Operation-2





USB MEMORY DEVICE PLAYBACK

- Play music files direct from a USB storage device.
- Only USB memory devices that conform to the high capacity storage standards below can be played.
- The LEAK CDT is compatible with "FAT16" and "FAT32" formats.
- The LEAK CDT will play WMA, MP3, WAV and AAC format audio files only.
- The USB port 5V 2A power output is used for supplying power to USB memory devices only. The USB port is not suitable for charging USB devices such as mobile phones or tablets.

USB PLAYBACK OPERATION

Plug the USB memory device to the front panel USB port.

Choose USB play by pressing the INPUT button on the remote control or front panel to navigate to USB playback mode.

-  Play/Pause by pressing the button on the remote control or front panel
-  In the play interface: press briefly to choose the previous/next song. On the front panel, hold down the buttons for fast forward and rewind functions. In the file list interface: press briefly to choose upwards or downward file browsing.
-  Press and hold to Fast reverse/Fast forward search (Remote control only).
-  Stop music file playback (press the front panel STOP button).
In the list interface: press briefly to return to the previous files; hold down to return to parent folder.
In the playback mode: hold down to switch playback between all files or the files in the folder.
Note: This function is the same as the remote control "FOLDER" key.

'A' / 'F' PLAYBACK

In the playback mode, hold down the "FOLDER" button on the remote control or the  button front panel to switch between 'A' and 'F' playback mode.

When "A" is selected, all the files in all the folders are played.

When "FOLDER" is selected, all the files in the selected folder are played.

REPEAT PLAY

Press the Repeat key on the remote control to switch between single file repeat, all files and sequence playback.

RANDOM PLAY

Press the remote control "RANDOM" button to choose track random play.

COMPATIBLE FORMATS

	Sampling frequency	Bit rate	Bit length	Extension
WMA	32/44.1/48kHz	32~320kbps	-	.wma
MP3	32/44.1/48kHz	32~320kbps	-	.mp3
WAV	32/44.1/48kHz	-	16 bit	.wav
AAC	32/44.1/48kHz	32~320kbps	-	.m4a

USB-COMPATIBLE FILE SYSTEMS

FAT16 or FAT32.

Note: if the USB memory device is divided into multiple partitions, only the top drive can be selected.

Maximum number of playable files and folders

Maximum number of files : 65,535

Maximum number of folders : 700

INFO DISPLAY SWITCH

In the playback mode, press the INFO button to show song information. The display will switch between title, artist name, album name, song genre and home interface play. In the list state, press the INFO button to return to home interface play.

Attention: The CDT will only show information in English text format. Non-English text may display error characters.

DISPLAY SETTING

Press the DISPLAY button on the remote to control the display ON/OFF.

When the display is OFF: Pressing any key will momentarily switch the display on. After a few moments the display will go off.

LEAK'CDT'
CD PLAYER WITH USB

I N S T A L L A T I O N - O P E R A T I O N - M A I N T E N A N C E

Warranty

LEAK warrants this product to be free from defects in materials and workmanship, subject to the terms and conditions below. During the warranty period LEAK will repair or replace (at LEAK's option) this product, or any defective part in this product, if it is found to be defective due to faulty materials, workmanship or function. The statutory warranty period may vary from country to country.

TERMS AND CONDITIONS

The warranty starts on the date of purchase as per the proof of purchase (or the date of delivery if this is later).

You must provide proof of purchase/delivery before work can be carried out. Without this proof, any work carried out will be subject to charge.

All work will be carried out by LEAK or its authorized agents or distributors.

Any unauthorized repair or modification will void this warranty.

If any part is no longer available it will be replaced with a functional replacement part.

Any parts that are replaced will become the property of LEAK.

Any repair or replacement under this warranty will not extend the original period of warranty.

This warranty is valid only in the county of purchase, applies only to the first purchaser and is not transferable.

THE FOLLOWING ARE NOT COVERED:

1. Products where the serial number has been removed, altered or otherwise made illegible.
2. Normal wear, tear and cosmetic damage.
3. Transportation or installation of the product.
4. Accidental damage, fault caused by commercial use, acts of God, incorrect installation, connection or packing, misuse, neglect or careless operation or handling of the product which is not in accordance with LEAK's user instructions.
5. Repairs or alterations carried out by parties other than LEAK or its authorized agents or distributors.
6. Products not purchased from an LEAK authorized dealer.
7. Products that were not new at the time of original purchase.
8. Products sold 'as is', 'as seen' or 'with all faults'.

Repairs or replacements as provided under this warranty are the exclusive remedy of the consumer.

LEAK shall not be liable for any incidental or consequential damages for breach of any express or implied warranty in this product. Except to the extent prohibited by law, this warranty is exclusive and in lieu of all other warranties whatsoever, both express and implied, including, but not limited to, the warranty of merchantability and fitness for a practical purpose.

This warranty provides benefits that are additional to and do not affect your statutory rights as a consumer.

Some countries and U.S. states do not allow the exclusion or limitation of incidental or consequential damages or implied warranties so the exclusions in the paragraph above may not apply to you. This warranty gives you specific legal rights, and you may have other statutory rights, which vary from state to state or county to county.

HOW TO CLAIM:

To obtain warranty service contact the LEAK authorized dealer from which you purchased this product. Do not dispatch goods without the prior agreement of the dealer, LEAK or their authorized distributors.

If asked to return products for inspection and/or repair, pack carefully, preferably in the original cartons or packing affording an equal degree of protection, and return prepaid. If unsuitable packaging is used, LEAK may make a charge for the supply of new packaging.

Insurance is recommended and goods are returned at owner's risk. LEAK or their authorized distributors cannot be held liable for loss or damage in transit.

LEAK

'CDT'
CD PLAYER WITH USB

INSTALLATION - OPERATION - MAINTENANCE

Specifications

Measurement made with 230V power supply

Model	CDT
USB Memory Device Audio Format	Supports WAV, MP3, AAC, WMA format
USB Memory Device File System	Supports FAT12, FAT16 & FAT32 format
Output Level	500 +/- 50mVpp
Output Impedance	75ohms
Frequency Response	-0.01dB (20Hz-20kHz,ref.1kHz)
Sampling Frequency	44.1kHz (CD) 44.1kHz, 48KHz (USB memory device)
Digital Output Interface	1 x Coaxial , 1 x Optical
Standby Power Consumption	< 0.5W
Power Requirement (Depend on your area)	220-240V ~ 50/ 60Hz 100-120V ~ 50/60Hz
Dimensions (mm)	302 x 117.1 x 278 (Silver) 326 x 145.1x 283 (Walnut)
Carton Size (mm)	475 x 248 x 450
Net Weight	5.3kg (Silver) 6.9kg (Walnut)
Finish	Silver/Walnut



Correct disposal of this product. This marking indicates that this product should not be disposed with other household wastes throughout the EU. To prevent possible harm to the environment or human health from uncontrolled waste disposal, recycle it responsibly to promote the sustainable reuse of material resources. To return your used device, please use the return and collection systems or contact the retailer where the product was purchased. They can take this product for environmental safe recycling.

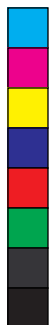

LEAK

IAG House, 13 /14 Glebe Road, Huntingdon, Cambridgeshire, PE29 7DL, UK
Tel: +44(0)1480 452561 Email: service@leak-hifi.co.uk Website: <http://www.leak-hifi.co.uk>

