

ASTRO BOD FAST

ANSI / ASSE : Z359.11 [2014]

Full-body fall arrest and positioning harness.
Harnais complet d'antichute et de positionnement.

WARNING / ATTENTION

Activities involving the use of this equipment are inherently dangerous. You are responsible for your own actions and decisions.

Before using this equipment, you must:

- Read and understand all Instructions for Use.
- Get specific training in its proper use.
- Become acquainted with its capabilities and limitations.
- Understand and accept the risks involved.

FAILURE TO HEED ANY OF THESE WARNINGS MAY RESULT IN SEVERE INJURY OR DEATH.

Les activités impliquant l'utilisation de cet équipement sont par nature dangereuses. Vous êtes responsable de vos actes, de vos décisions et de votre sécurité.

Avant d'utiliser cet équipement, vous devez :

- Lire et comprendre toutes les instructions d'utilisation.
- Vous former spécifiquement à l'utilisation de cet équipement.
- Vous familiariser avec votre équipement, apprendre à connaître ses performances et ses limites.
- Comprendre et accepter les risques induits.

LE NON-RESPECT D'UN SEUL DE CES AVERTISSEMENTS PEUT ÊTRE LA CAUSE DE BLESSURES GRAVES OU MORTELLES;

Warning symbols
Panneaux d'alertes



Traceability and markings Traçabilité et marquage

a. CE 0082
APAVE SUDEUROPE SAS
3 rue Jean-Jacques Vermaza
Z.A.C. Saumaty-Séon - CS 60193
13322 Marseille CEDEX 16 France
N°0082

b. Certification organization

e. Serial number / Numéro de série
YY M 0000000 000

f. **g.** **h.** **i.**

j. **k.** **l.** **m.**

n.

o.

ASTRO BOD FAST
CE 0082
Polyester / polyamide
PETZL
38920 Croles
France
www.petzl.com/contact
Tel. +33-(0)4 76 92 09 00

DoubleBack / DoubleBack Plus
Close / Fermer

Fast
Close / Fermer

ANSI Z359.11-14

PETZL.COM



Latest version
Dernière version



Other languages
Autres langues



Technical tips
Conseils techniques



PPE checking
Fiche de contrôle EPI

PETZL
F-38920 Croles
Cidex 105A
PETZL.COM
ISO 9001
© PETZL



Sustaining our Community
Au service de la Communauté
Fondation **FONDATION-PETZL.ORG**

1. Field of application Champ d'application

2. Nomenclature

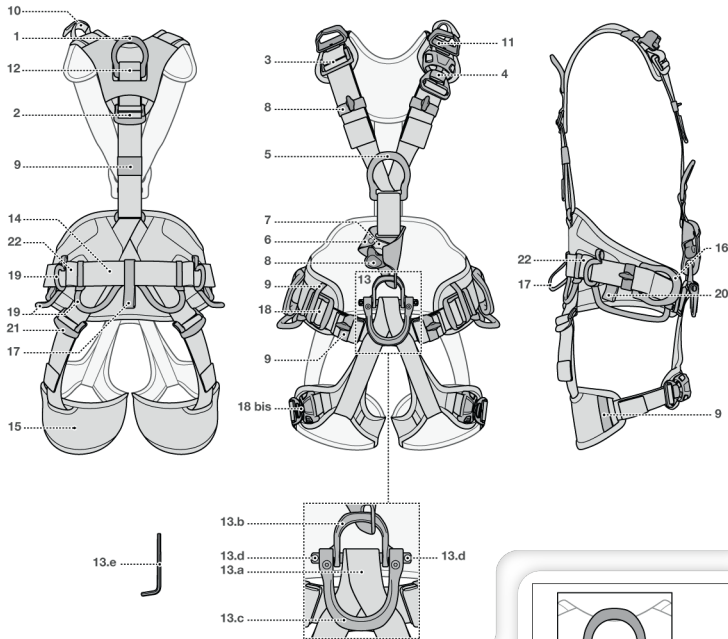

3. Inspection, points to verify Contrôle, points à vérifier

PPE checking
Vérification EPI
PETZL.COM



4. Compatibility (text part) Compatibilité (partie texte)

Gated ventral attachment point / Point d'attache ventral ouvrable

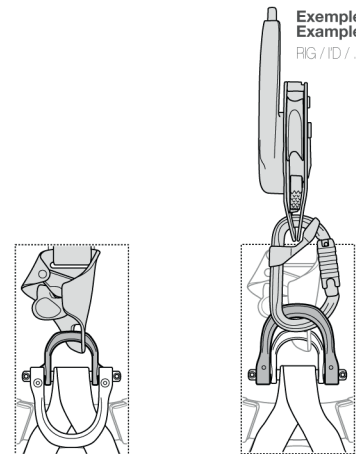
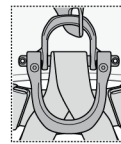

PODIUM

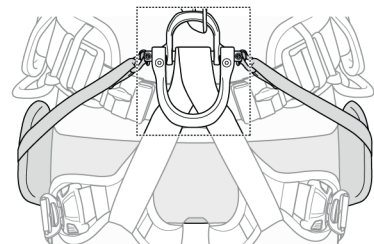

5. How to put the harness on
Mise en place du harnais

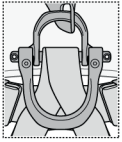

Gated ventral attachment point /
Point d'attache ventral ouvrable

Open / Ouvrir

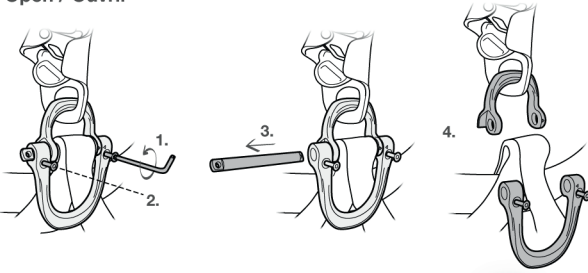

Close / fermer

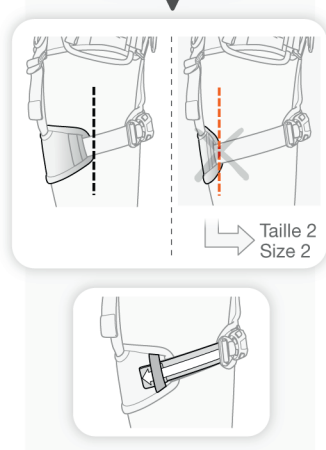
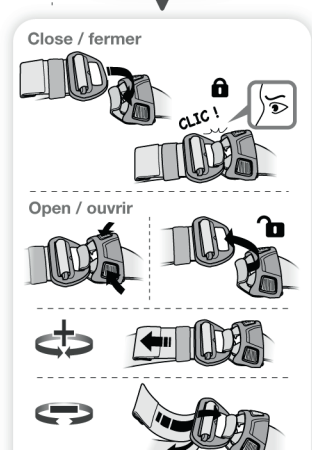
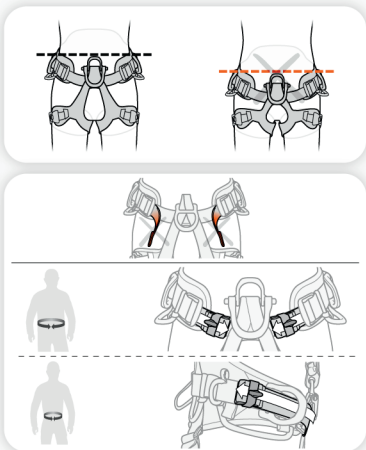
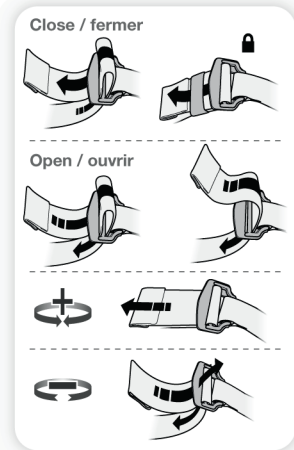
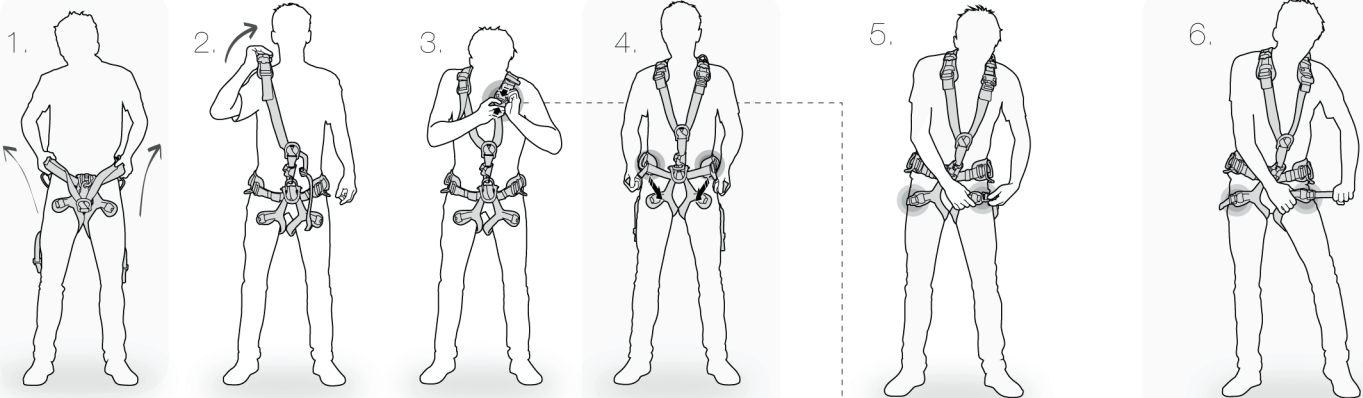
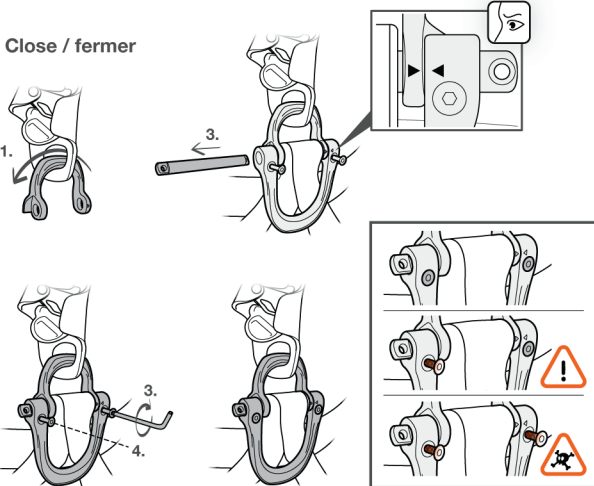

5. How to put the harness on
Mise en place du harnais

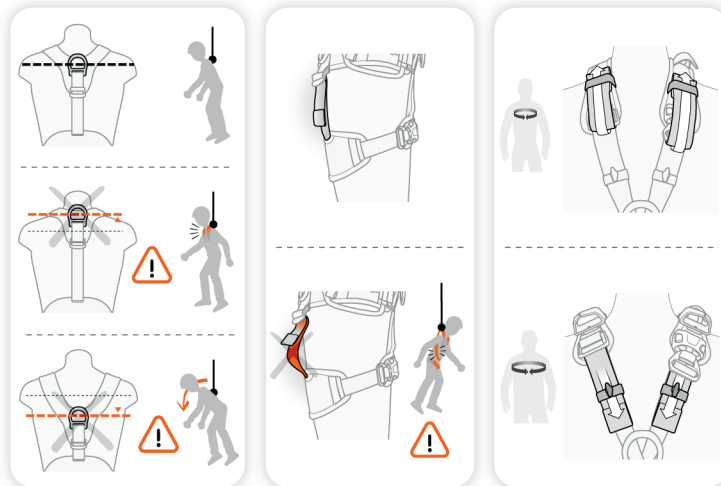
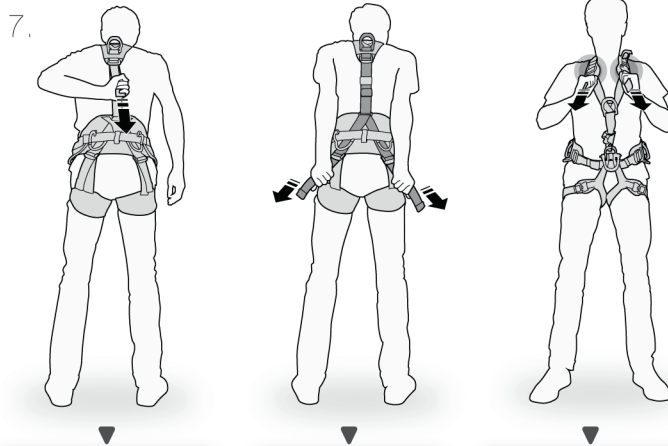

6. Fall arrest harness
Harnais d'antichute

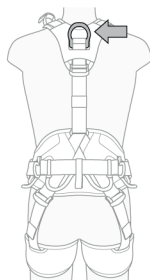

8. CROLL L ventral rope clamp
Bloqueur ventral CROLL L

Function principle and test
Principe et test de fonctionnement

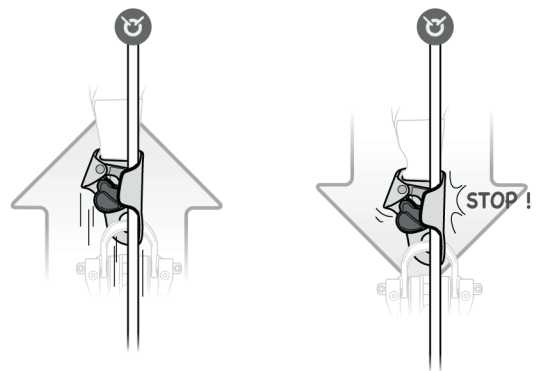

Installing and removing the rope
Mise en place de la corde

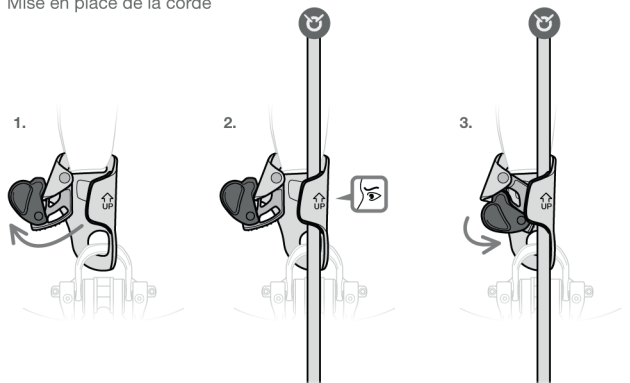

7. Positioning and travel restraint harness
Harnais de positionnement et de retenue

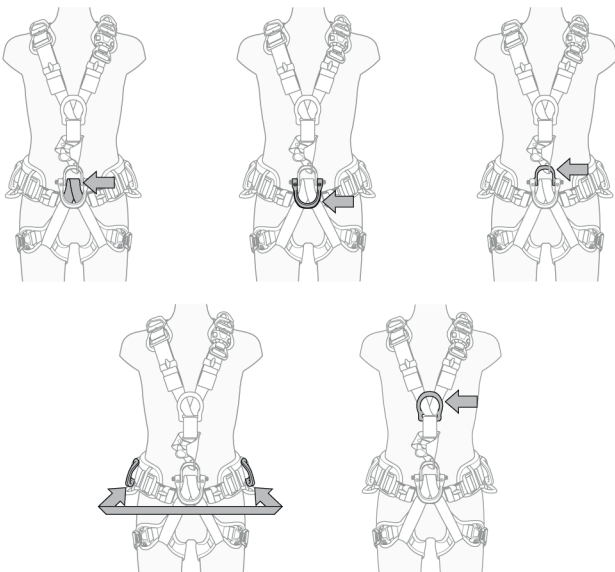

8. CROLL L ventral rope clamp
Bloqueur ventral CROLL L

Rope ascending
Remontée sur corde

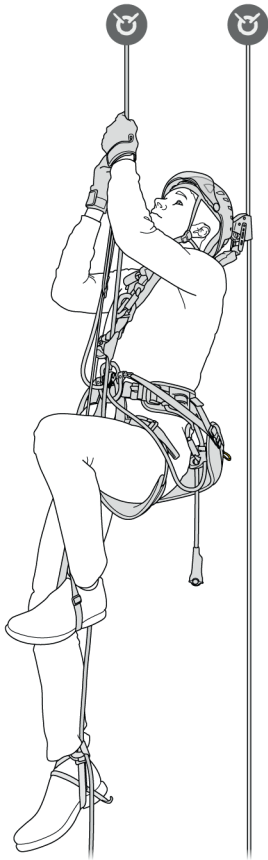

Angled traverse situation
Cas de traversée en oblique

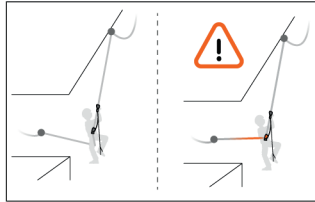

Short rope descent
Courte descente

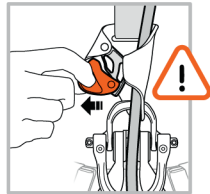
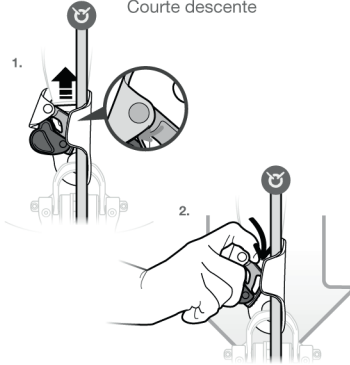

9. Equipment loops
Porte-matériels

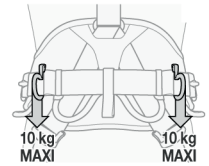
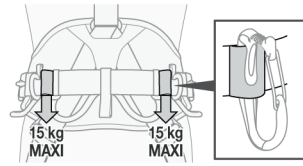
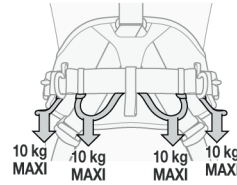

Velcro keeper /
Passant Velcro



10. Fall arrest lanyard connector holder
Porte-connecteurs de longe d'antichute

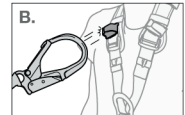
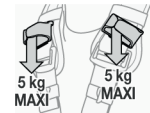
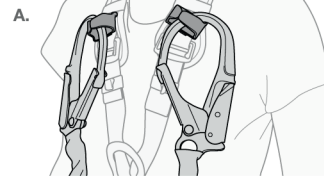

12. ANSI additional information (text part)
Informations complémentaires ANSI (partie texte)

11. Accessoires
Accessoires

PODIUM

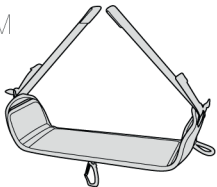

Shackles for PODIUM seat
Manilles pour sellette PODIUM

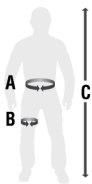

	A	B	C
Taille 0	65 - 80 cm 26 - 31 inch	44 - 59 cm 18 - 23 inch	160 - 180 cm 63 - 70 inch
Taille 1	70 - 93 cm 28 - 36 inch	47 - 62 cm 19 - 24 inch	165 - 185 cm 65 - 72 inch
Taille 2	83 - 120 cm 33 - 46 inch	50 - 65 cm 20 - 25 inch	175 - 200 cm 69 - 78 inch

13. Additional information
Informations complémentaires



A. Lifetime / Durée de vie

Serial n° / N° de série
 XXX XX XXXX + 10 years ans

B. Markings
Marquage



C. Acceptable T°
T° tolérées

+ 80°C / + 176°F
 - 40°C / - 40°F

D. Precautions for use / Précautions d'usage



E. Cleaning - Disinfection / Nettoyage - Désinfection



F. Drying / Séchage



G. Storage - Transport
Stockage - transport



I. Modifications - Repairs
Modifications - Réparations



J. FAQ - Contact
Questions - Contact



A. Lifetime / Durée de vie

unlimited illimitée

C. Acceptable T°
T° tolérées

+ 80°C / + 176°F
 - 40°C / - 40°F

D. Precautions for use / Précautions d'usage



E. Cleaning / Nettoyage



F. Drying / Séchage

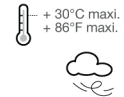

G. Storage - Transport
Stockage - transport



H. Maintenance
Entretien



I. Modifications - Repairs
Modifications - Réparations

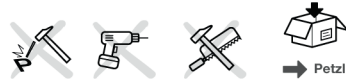

J. FAQ - Contact
Questions - Contact



