

Io

Scheda tecnica
Technical sheet

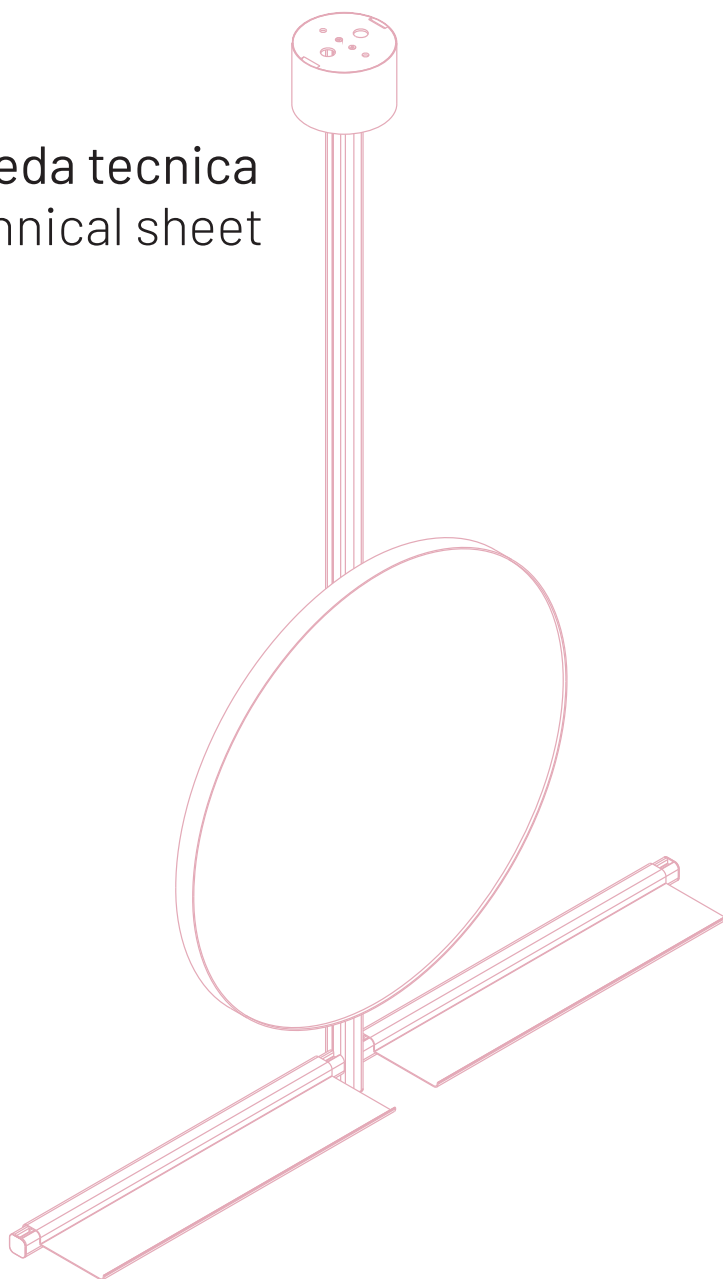

Damiano Latini s.r.l.
Via Tangenziale 14/16,
62010 - Montecosaro (MC)
email: info@damianolatini.it
P.IVA 01410060436





IO

Design essenziale e versatilità sono le caratteristiche chiave che rendono IO una soluzione di arredo bagno funzionale ed elegante, ideale per la casa e per il mondo dell'ospitalità. IO è un sistema sospeso di mensole e accessori progettato per arredare bagni anche di piccole dimensioni. Grazie al design versatile e alla modularità della struttura, IO consente di ottimizzare lo spazio mantenendo l'appeal estetico. Disponibile in due moduli, singolo o doppio, IO si fissa al soffitto per scendere sospeso sopra al lavabo. Il montante verticale è dotato di una cava posteriore per ospitare la strip LED e di due binari laterali per agganciare i profili orizzontali. Grazie a un innovativo sistema di aggancio, gli accessori possono scorrere lungo il binario ed essere fissati all'altezza preferita.

Essential design and flexibility are the key distinctive features that make IO a smart bathroom furnishing solution for homes and the hospitality industry. IO is a suspended open storage system especially suitable for smaller bathrooms. Thanks to a flexible design, custom height and width, IO is a tailor-made solution that allows to maximize storage spaces while keeping the aesthetics appeal. IO is available in two modules, single with one vertical stud and double with two vertical studs both fastened to the ceiling and suspended over the washbasin. The vertical profiles have a back groove to hold the strip LED and two side binaries for the horizontal profiles. Thanks to a new and advanced hooking system the accessories can move along the binary and be easily fixed at the preferred distance.

designer: Nunzia Ponsillo Design Studio







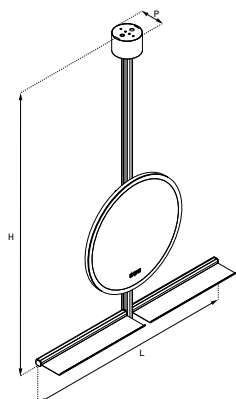

IO singolo

Materiale / Material
Alluminio / Aluminum



L cm	115.0
H cm	157.5
P cm	14.0

FINITURE / FINISHES

-  Nero / Black
-  Titanio / Titanium
-  Bronzo / Bronze

IO doppio

Materiale / Material
Alluminio / Aluminum

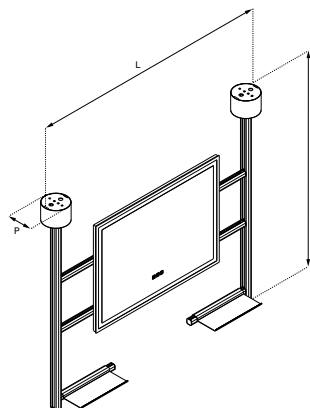

L cm	137.5
H cm	157.5
P cm	14.0

FINITURE / FINISHES

-  Nero / Black
-  Titanio / Titanium
-  Bronzo / Bronze

ILLUMINAZIONE

IO viene fornito con sistema d'illuminazione D-Motion che consente la selezione della temperatura colore (2700 K o 4000 K) di tutte le sorgenti luminose integrate nella specchiera e nella struttura. La specchiera è dotata di un sistema di controllo con tre interruttori touch che attivano l'accensione e lo spegnimento delle sorgenti luminose, la selezione della temperatura colore e l'attivazione del sistema anti appannamento. Le sorgenti luminose e la specchiera sono protetti con grado IP44 contro gli spruzzi d'acqua. Questo prodotto contiene una sorgente luminosa di classe di efficienza energetica D.

LIGHTENING

IO is supplied with the D-Motion lighting system which allows the selection of the color temperature (2700 K or 4000 K) of all the light sources integrated in the mirror and in the structure. The mirror is equipped with a control system with three touch switches that activate the switching on and off of the light sources, the selection of the color temperature and the activation of the anti-fog system. The light sources and the mirror are IP44 protected against splashing water. This product contains a light source of energy efficiency class D.



LED



230 V





SISTEMA DI FISSAGGIO

Il sistema di fissaggio delle barre consente di farle scorrere su tutta la lunghezza del montante e posizionarle in base alle esigenze dei clienti. Per fare ciò è stato studiato un sistema che attraverso l'uso di una vite va a stringere e allargare un "forchettina" da noi progettata che fa presa sul binario presente nel montante.

FIXING SYSTEM

The fixing system of the bars allows them to slide along the entire length of the upright and position them according to customer needs. a system has been studied which through the use of a screw tightens and widens a "fork" designed by us that grips the rail present in the upright.

DETTAGLIO DEL FISSAGGIO / FIXING DETAIL

La barra orizzontale può scorrere lungo il binario ed essere fissata all'altezza che si preferisce.

The horizontal bar can slide along the track and be fixed at the desired height.

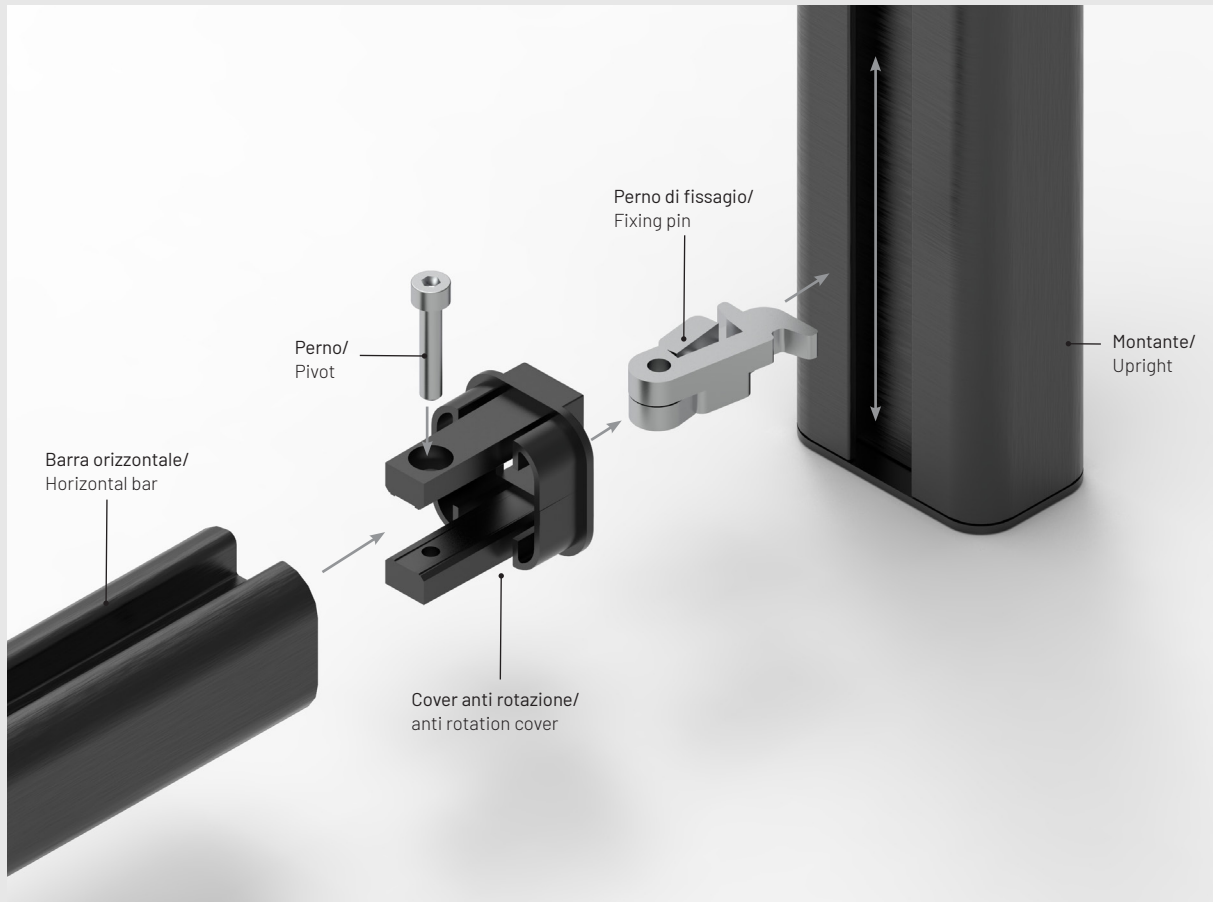

Mensola 55 / Shelf 55

Materiale / Material
Alluminio / Aluminium

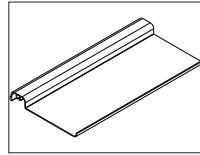
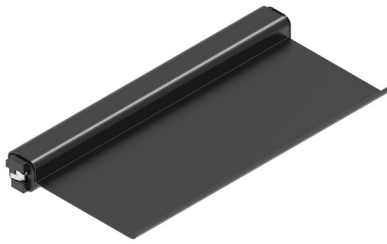

Kg. 0.3

L cm 30.0

H cm 2.0

P cm 15.6

FINITURE / FINISHES

■ Nero / Black ■ Titanio / Titanium ■ Bronzo / Bronze

Gancio / Hook

Materiale / Material
Alluminio / Aluminium

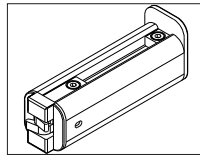

Kg. 0.3

L cm 10.0

H cm 4.0

P cm 3.0

FINITURE / FINISHES

■ Nero / Black ■ Titanio / Titanium ■ Bronzo / Bronze

Mensola con foro / Shelf with hole

Materiale / Material
Alluminio / Aluminium

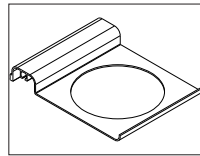
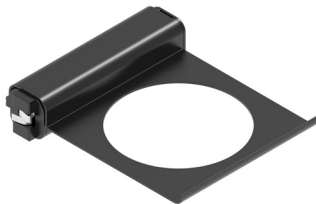

Kg. 0.1

L cm 12.0

H cm 2.0

P cm 15.6

FINITURE / FINISHES

■ Nero / Black ■ Titanio / Titanium ■ Bronzo / Bronze

Bicchiere in metallo / Metal glass

Materiale / Material
Ferro / Iron

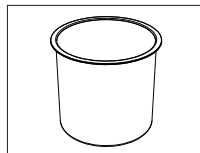

Kg. 0.3

L cm 10.0

H cm 9.0

P cm 10.0

FINITURE / FINISHES

■ Nero / Black ■ Titanio / Titanium ■ Bronzo / Bronze