

Dama-L

Scheda tecnica
Technical sheet

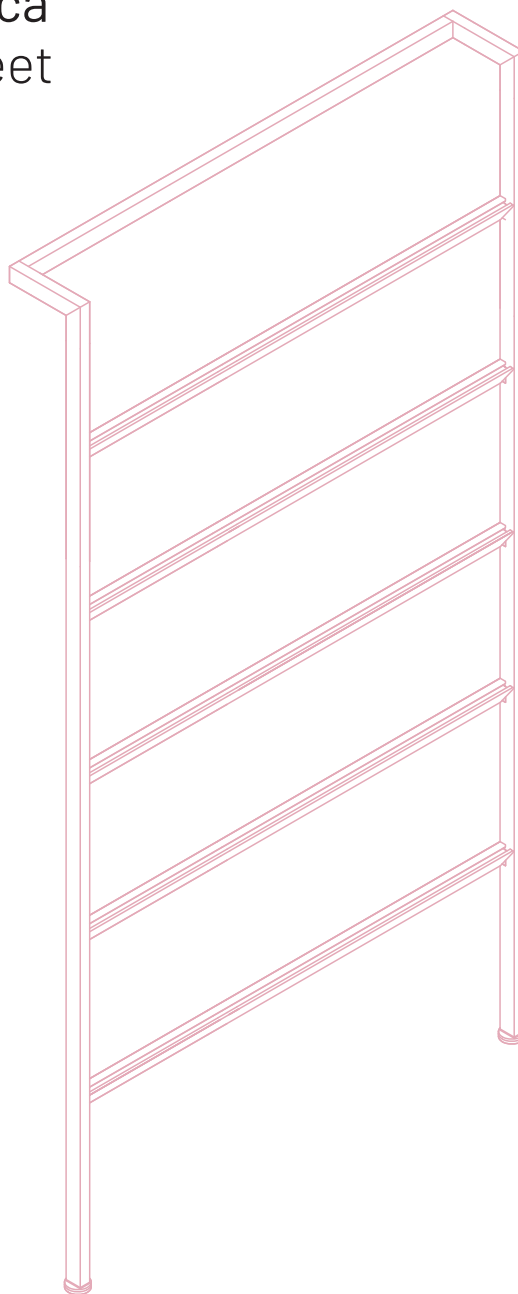

Damiano Latini s.r.l.
Via Tangenziale 14/16,
62010 - Montecosaro (MC)
email: info@damianolatini.it
P.IVA 01410060436





DAMA-L

Pratica ed elegante, Dama L è una struttura con profili di alluminio componibili, espandibile a seconda delle esigenze di spazio. Naturale evoluzione di Dama, è dotata di supporti a 90° nella parte superiore per distanziarla dalla parete e di piedini regolabili nella parte inferiore per un preciso e stabile appoggio a pavimento. Grazie a una vasta gamma di componenti, può diventare un meraviglioso orto verticale interno, dotato di luci fitostimolanti che aiutano le piante officinali a crescere in casa.

Practical and elegant. Dama L is a fitted structure made of aluminium profiles and a completely bespoke piece to your specific measurements. It is dama natural evolution. It is equipped with 90-degree supports at the top to distance it from the wall and adjustable feet at the bottom for a precise and stable floor stand. Thanks to a wide range of components you can even use it as a wonderful, upright interior garden, equipped with phyto-stimulating lights to help you grow officinal plants at the home.





DAMA L 140

Materiale / Materials
Alluminio / Aluminium





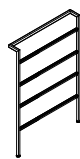

140X60



140X90

Kg.	4.2	5.3
L cm	64.00	94.0
L1 cm	60.0	90.0
H cm	141.0	141.0
P cm	15.5	15.5
X1 cm	32.8	32.8
X2 cm	25.6	25.6

FINITURE / FINISHES

-  Silver dark / Silver dark
-  Grigio selce / Fint
-  Nero / Black
-  Bianco / White
-  Ghisa / Cast iron

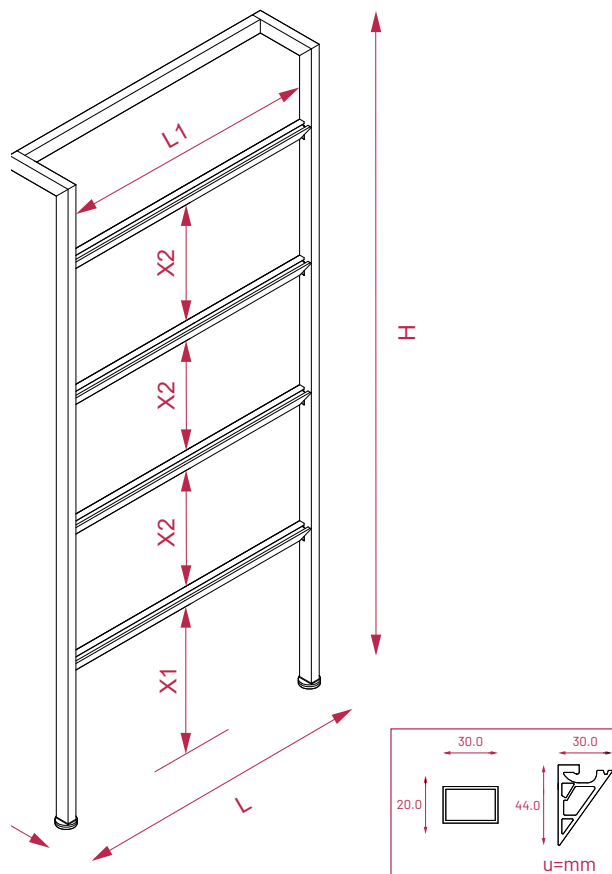

DAMA L 180

Materiale / Materials
Alluminio / Aluminium



140X60



140X90

Kg.	5.1	6.5
L cm	64.0	94.0
L1 cm	60.0	90.0
H cm	181.0	181.0
P cm	15.5	15.5
X1 cm	32.8	32.8
X2 cm	25.6	25.6

FINITURE / FINISHES

-  Silver dark / Silver dark
-  Grigio selce / Fint
-  Nero / Black
-  Bianco / White
-  Ghisa / Cast iron

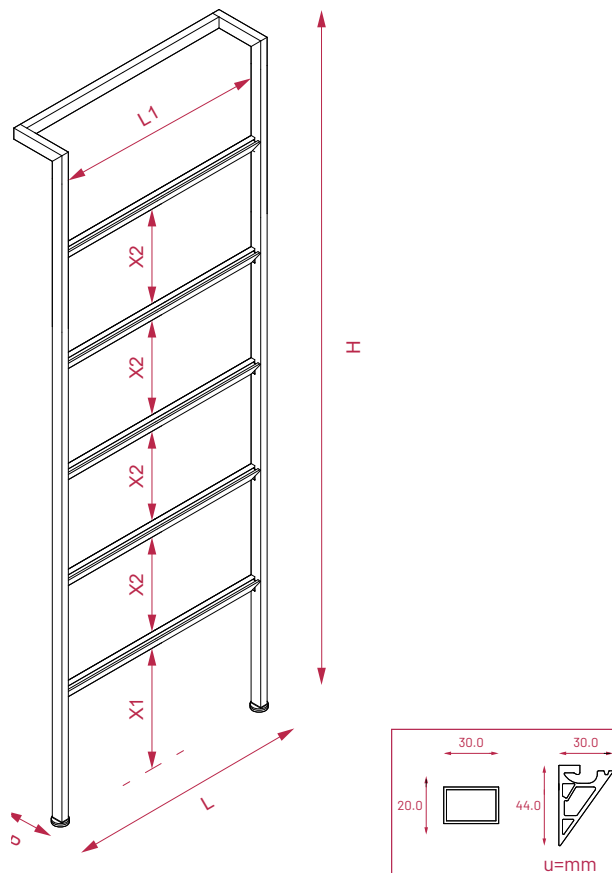

Accessori / Accessories

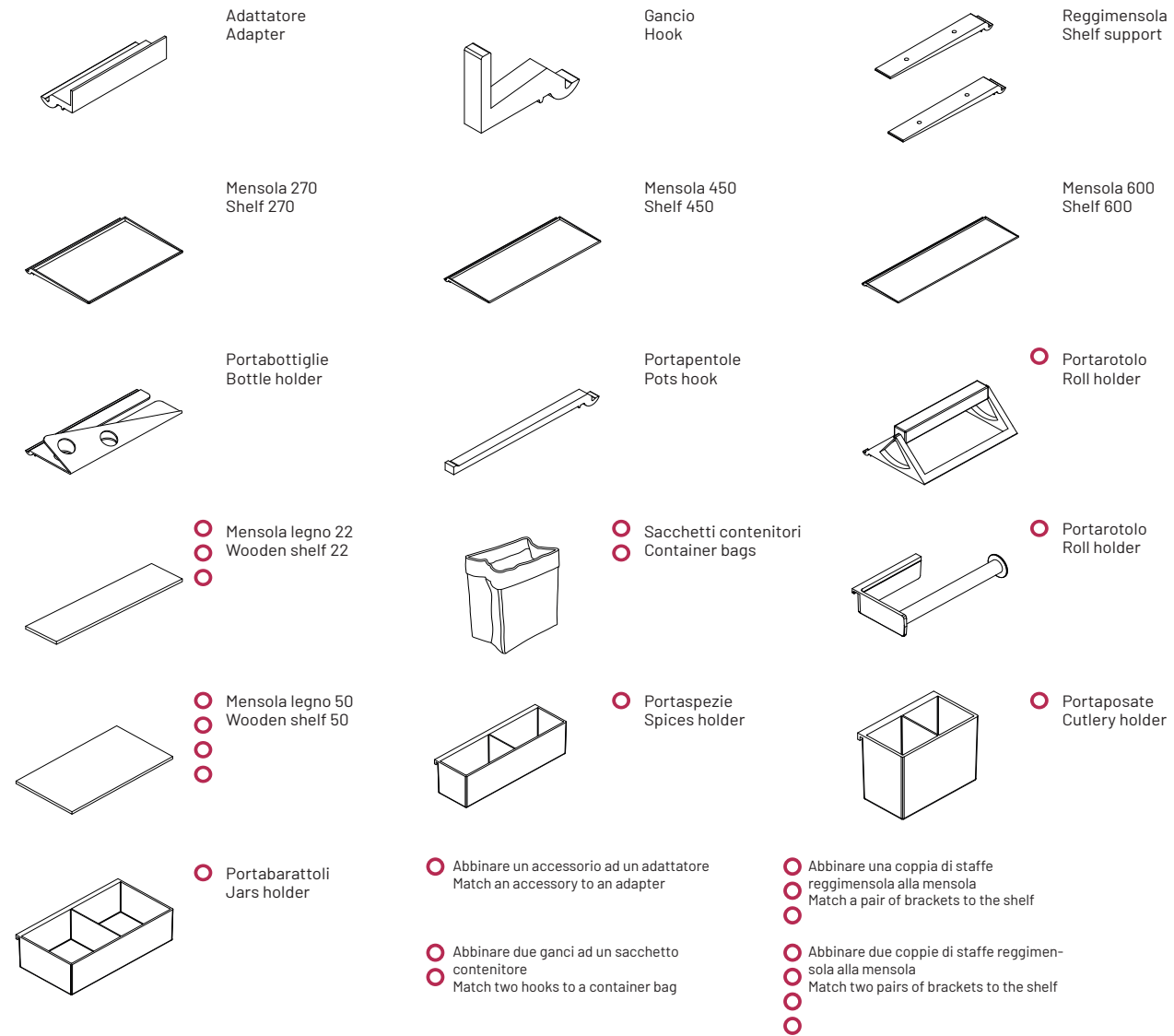

Finiture/ Finishes

Metallo / Metal



Finiture struttura, mensole, gancio, portabottiglie e portapentole
Structure, shelves, adapter, hook, bottles holder and pots hook finishes

	Nero / Black
	Ghisa / Cast iron
	Bianco / White
	Grigio selce / Fint
	Silver dark / Silver dark

Legno melaminico / Melamine wood

Finiture mensole







Shelves finishes

	Rovere ortisei / Ortisei durmast
	Noce tundra / Tundra walnut

Legno impiallacciato / Veneered wood

Finiture mensole



Shelves finishes

	Noce canaletto / Canaletto walnut
	Rovere spaccato / Split durmast
	Rovere dove / Dove durmast
	Rovere dark / Dark durmast
	Frassino bianco / White ash
	Frassino nero / Black ash

Legno laccato / Lacquered wood

Finiture mensole

Shelves finishes

	Nero opaco / Matte black
	Bianco opaco / Matte white
	Grigio opaco / Matte grey

Plastica / Plastic

Finiture portarotolo, portaposate, portaspezie e portabarattoli

Roll holder, cutlery holder, spices holder, jars holder finishes

	Ghisa / Cast iron
	Nero / Black
	Bianco / White
	Vulcano / Volcan
	Giallo ambra / Amber
	Salvia / Sage
	Conchiglia / Shell
	Grigio traffico / Traffic grey
	Tortora / Dove

Dama-L

Scheda di montaggio
Assembly instructions

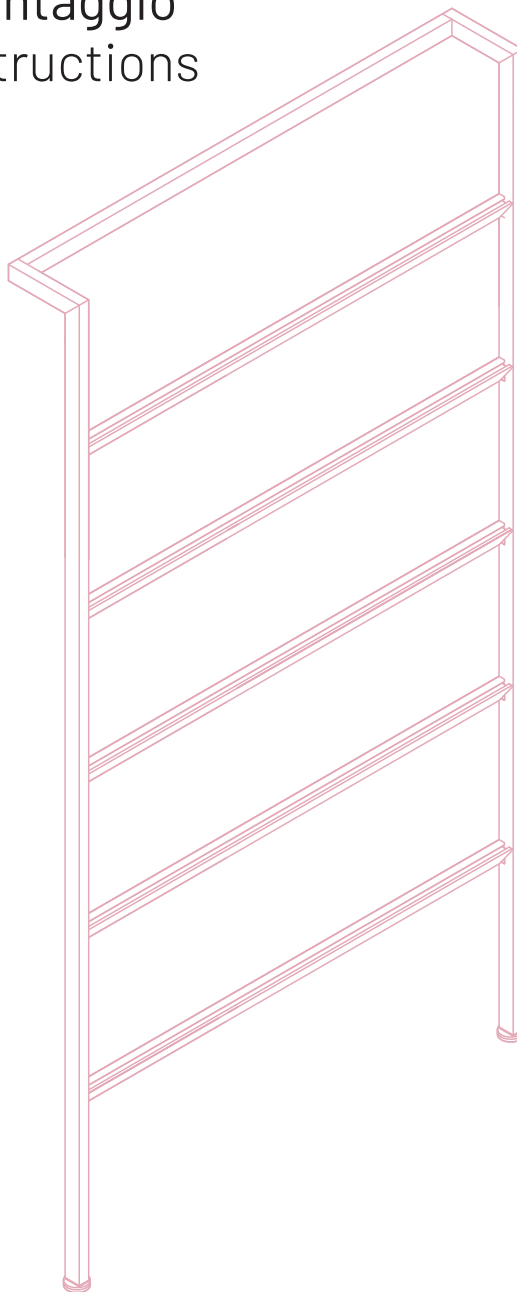

Damiano Latini s.r.l.
Via Tangenziale 14/16,
62010 - Montecosaro (MC)
email: info@damianolatini.it
P.IVA 01410060436

Dama-L 140

Materiale | Materials

- A** Vite da muro + tassello
Self-tapping screws + wall plug
N.2 pcs (5 x 50 mm)
- B** Vite per ferro
Metric screws
N.16 pcs (4 x 8 mm)
- C** Grani a testa esagonale
Hexagonal head grains
N.16 pcs (4 x 5 mm)
- D** Vite metrica
Metric screws
N.2 pcs (4 x 10 mm)
- Pin di incastro sx e dx
Locking pin sx e dx
N.16 pcs
- 1 Barre orizzontali forate
Horizontal drilled profiles
N.4 pcs +1 pcs
- Profili verticali ad L
L-Vertical profile
N.2 pcs

Strumenti necessari | Required tools

Trapano | Drill

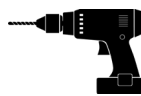

Cacciavite a croce | Phillips Screwdriver



Chiave a brugola | Allen key



Punta trapano | Drill bit



This is in the box!

1 Prendere le misure | Drawing measures

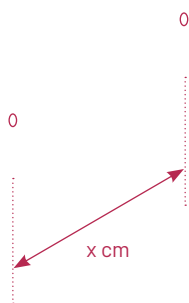

Segnare dove forare per montare l'attaccaglia.

Draw where to drill the wall.

2 Forare il muro | Drill and fix on the wall

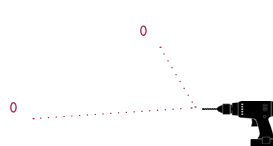

Forare il muro e inserire stop e viti.

Drill the wall, then insert wall plugs and screws.

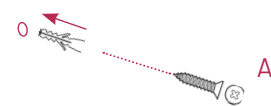

3 Agganciare i pin | Fit pins

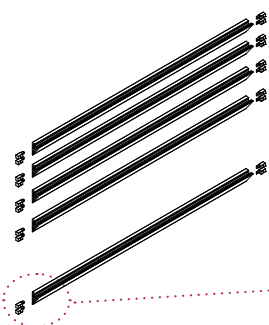

Agganciare i pin destri e sinistri sulle barre orizzontali.

Insert left and right pins in the horizontal profiles.

SX

DX

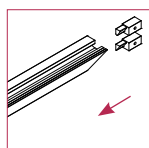
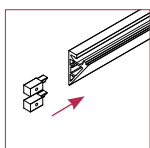

4 Assemblare gli elementi | Assembly the elements

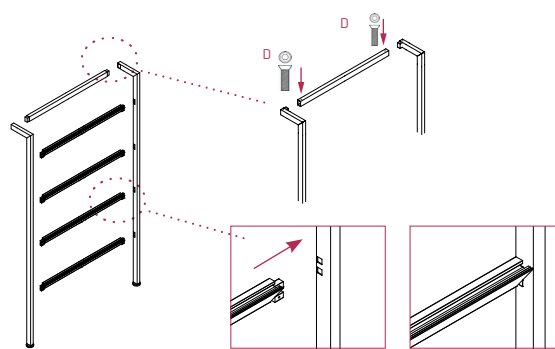

5 Avvitare i pin | Fix pins

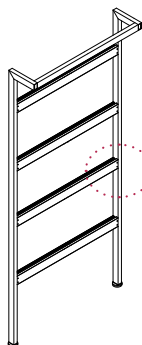

Avvitare **prima** il montante verticale poi l'orizzontale.
Screw **first** vertical profile than horizontal.

1

2

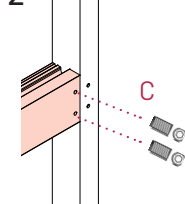
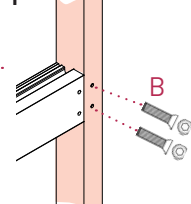

6 Agganciare a parete | Hook to wall

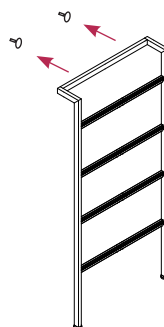

Agganciare la struttura Dama-L al supporto fissato a muro al passo 2.

Hook Dama-L structure to fixed support described on step 2.

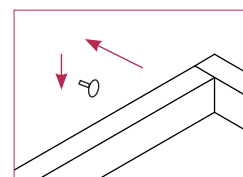

DAMIANO
LATINI

Damiano Latini s.r.l.
Via Tangenziale 14/16,
62010 - Montecosaro (MC)
email: info@damianolatini.it
P.IVA 01410060436

Dama-L 180

Materiale | Materials

- A** Vite da muro + tassello
Self-tapping screws + wall plug
N.2 pcs (5 x 50 mm)
- B** Vite per ferro
Metric screws
N.20 pcs (4 x 8 mm)
- C** Grani a testa esagonale
Hexagonal head grains
N.20 pcs (4 x 5 mm)
- D** Vite metrica
Metric screws
N.2 pcs (4 x 10 mm)
- Pin di incastro sx e dx
Locking pin sx e dx
N.20 pcs
- 1 Barre orizzontali forate
Horizontal drilled profiles
N.5 pcs +1 pcs (with hole)
- Profili verticali ad L
L-Vertical profile
N.2 pcs

Strumenti necessari | Required tools

Trapano | Drill



Cacciavite a croce |
Phillips Screwdriver



Chiave a brugola | Allen
key



Punta trapano | Drill bit



This is in the box!

1 Prendere le misure | Drawing measures

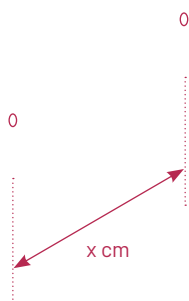

Segnare dove forare per
montare l'attaccaglia.

Draw where to drill the
wall.

2 Forare il muro | Drill and fix on the wall

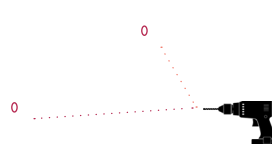

Forare il muro e inserire stop
e viti.

Drill the wall, then insert wall
plugs and screws.

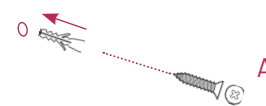

3 Agganciare i pin | Fit pins

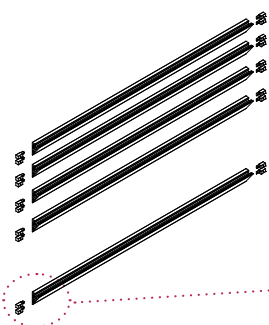

Agganciare i pin destri e sinistri sulle
barre orizzontali.

Insert left and right pins in the
horizontal profiles.

SX

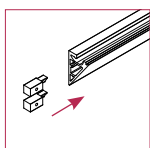

dx

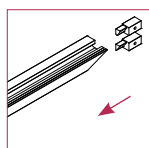

4 Assemblare gli elementi | Assembly the elements

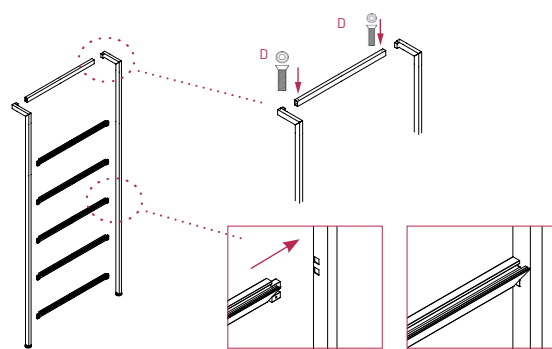

5 Avvitare i pin | Fix pins

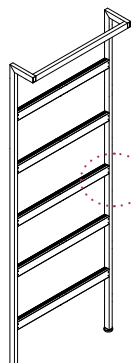

Avvitare **prima** il montante verticale
poi l'orizzontale.
Screw **first** vertical profile than
horizontal.

1

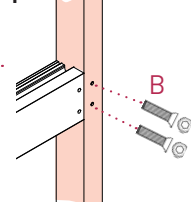

2

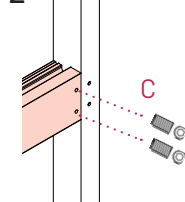

6 Agganciare a parete | Hook to wall

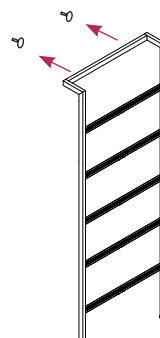

Agganciare la struttura Dama-L al
supporto fissato a muro al passo 2.

Hook Dama-L structure to fixed
support described on step 2.

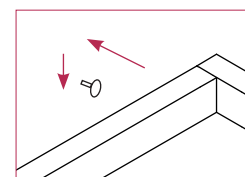

DAMIANO
LATINI

Damiano Latini s.r.l.
Via Tangenziale 14/16,
62010 - Montecosaro (MC)
email: info@damianolatini.it
P.IVA 01410060436

Dama-L

Scheda di montaggio
Assembly instructions

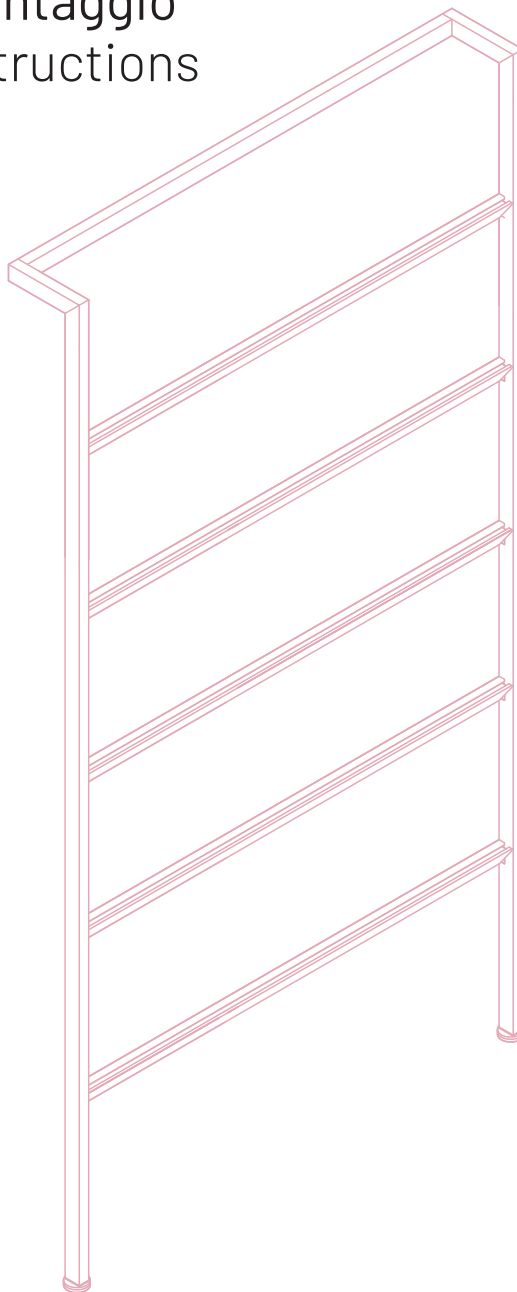

Damiano Latini s.r.l.
Via Tangenziale 14/16,
62010 - Montecosaro (MC)
email: info@damianolatini.it
P.IVA 01410060436

Dama-L 140

Materiale | Materials

- A** Vite da muro + tassello
Self-tapping screws + wall plug
N.2 pcs (5 x 50 mm)
- B** Vite per ferro
Metric screws
N.16 pcs (4 x 8 mm)
- C** Vite metrica
Metric screws
N.2 pcs (4 x 10 mm)
- Connettori
Connector
N.2 pcs
- Pin di incastro sx e dx
Locking pin sx e dx
N.8 pcs
- 1 Barre orizzontali forate
Horizontal drilled profiles
N.4 pcs +1 pcs
- 4
- Profili verticali ad L
L-Vertical profile
N.2 pcs

Strumenti necessari | Required tools

Trapano | Drill



Cacciavite a croce |
Phillips Screwdriver



Chiave a brugola | Allen
key

Punta trapano | Drill bit



1 Prendere le misure | Drawing measures

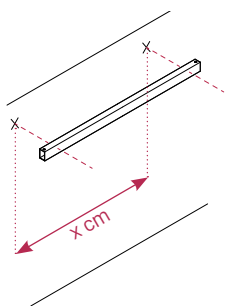

Segnare dove forare per montare la barra orizzontale superiore

Draw where to drill the wall for the upper horizontal bar

2 Forare il muro | Drill and fix on the wall

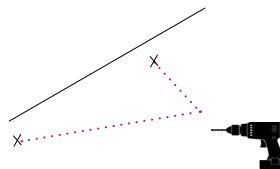

Forare il muro e inserire stop e viti.

Drill the wall, then insert wall plugs and screws.

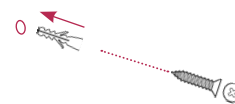

3 Agganciare i pin | Fit pins

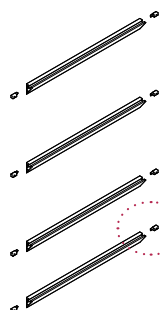

Agganciare i pin destri e sinistri sulle barre orizzontali.

Insert left and right pins in the horizontal profiles.

SX

dx

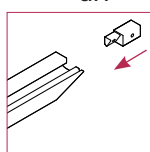
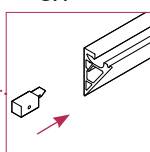

4 Assemblare gli elementi | Assembly the elements

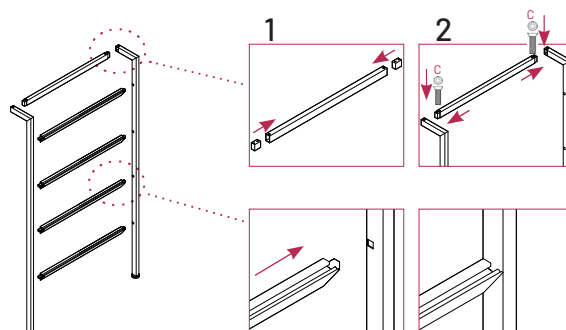

5 Avvitare i pin | Fix pins

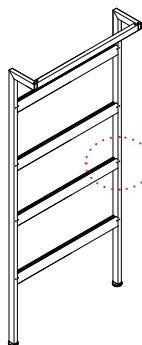

Avvitare **prima** il montante verticale poi l'orizzontale.

Screw **first** vertical profile than horizontal.

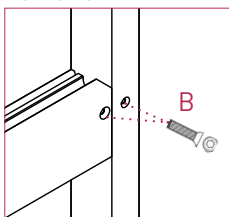

6 Agganciare a parete | Hook to wall

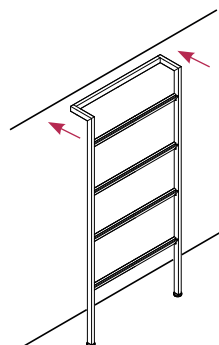

Agganciare la struttura Dama L alle viti a parete

Hook Dama L structure to the screws in the wall.

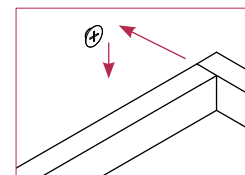

DAMIANO
LATINI

Damiano Latini s.r.l.
Via Tangenziale 14/16,
62010 - Montecosaro (MC)
email: info@damianolatini.it
P.IVA 01410060436

Dama-L 180

Materiale | Materials

- A** Vite da muro + tassello
Self-tapping screws + wall plug
N.2 pcs (5 x 50 mm)
- B** Vite per ferro
Metric screws
N.20 pcs (4 x 8 mm)
- C** Vite metrica
Metric screws
N.2 pcs (4 x 10 mm)
- Connettori
Connector
N.2 pcs
- Pin di incastro sx e dx
Locking pin sx e dx
N.20 pcs
- 1 Barre orizzontali
Horizontal profiles
N.5 pcs +1 pcs (with hole)
- Profili verticali ad L
L-Vertical profile
N.2 pcs

Strumenti necessari | Required tools

Trapano | Drill



Cacciavite a croce |
Phillips Screwdriver



Chiave a brugola | Allen
key

Punta trapano | Drill bit



1 Prendere le misure | Drawing measures

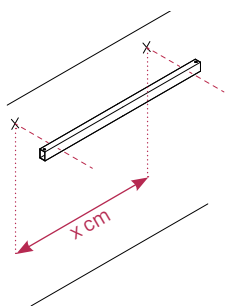

Segnare dove forare
per montare la barra
orizzontale superiore

Draw where to drill
the wall for the upper
horizontal bar

2 Forare il muro | Drill and fix on the wall

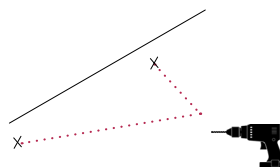

Forare il muro e inserire stop
e viti.

Drill the wall, then insert wall
plugs and screws.

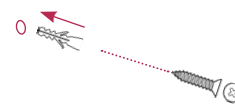

3 Agganciare i pin | Fit pins

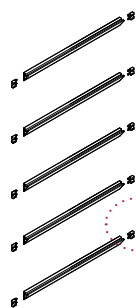

Agganciare i pin destri e sinistri sulle
barre orizzontali.

Insert left and right pins in the
horizontal profiles.

SX

dx

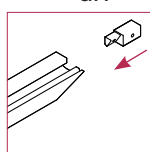
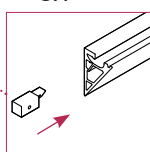

4 Assemblare gli elementi | Assembly the elements

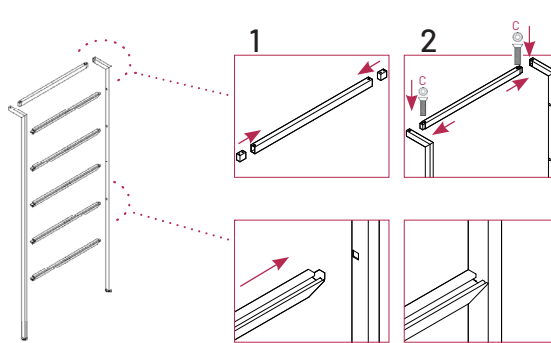

5 Avvitare i pin | Fix pins

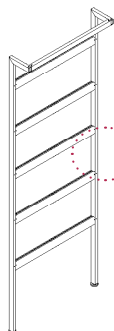

Avvitare **prima** il montante verticale
poi l'orizzontale.

Screw **first** vertical profile than
horizontal.

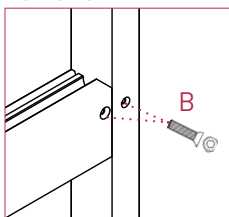

6 Agganciare a parete | Hook to wall

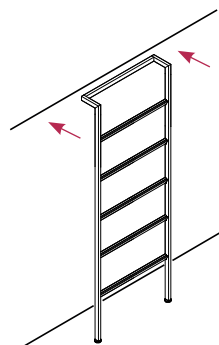

Agganciare la struttura Dama L
alle viti a parete

Hook Dama L structure to the
screws in the wall.

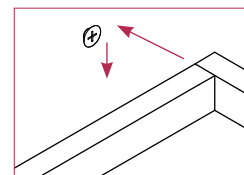

DAMIANO
LATINI

Damiano Latini s.r.l.
Via Tangenziale 14/16,
62010 - Montecosaro (MC)
email: info@damianolatini.it
P.IVA 01410060436