

Step

Scheda tecnica
Technical sheet

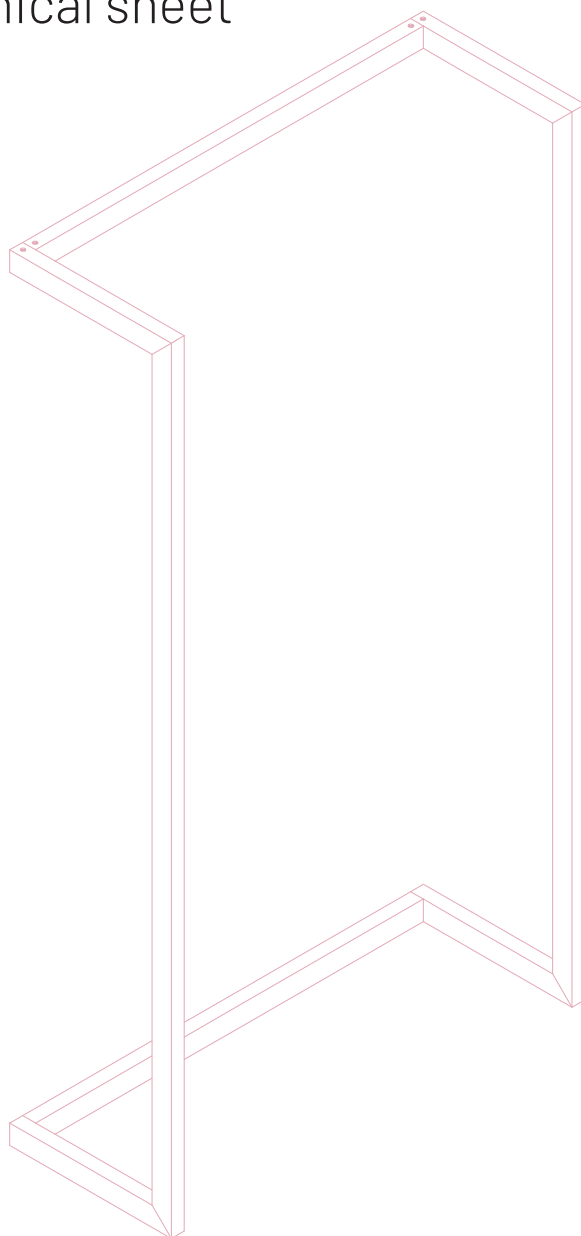

Damiano Latini s.r.l.
Via Tangenziale 14/16,
62010 - Montecosaro (MC)
email: info@damilanlatini.it
P.IVA 01410060436





STEP

Sottile e minimale Step è una struttura in alluminio montata a parete dalle dimensioni compatte ed eleganti. Le mensole che la compongono possono essere sottili piatti di metallo o di legno. Le dimensioni compatte le permettono di essere utilizzata come complemento d'arredo sia in cucina che in soggiorno oppure in bagno come sofisticato porta oggetti.







Step is a thin and minimal wall-mounted metal structure with compact and elegant dimensions. Its shelves can be thin metal or wooden dishes. Its compact size allows any furnishing accessory use in the kitchen or living room but also as a sophisticated objectholder in the bathroom.





STEP

Materiale / Materials
Alluminio / Aluminium

						
	STEP/360	STEP/600	STEP/720	STEP/1200	STEP/1800	STEP/2040
Kg.	0.60	0.98	1.15	1.90	2.85	3.20
L cm	64.0	64.0	64.0	64.0	64.0	64.0
H cm	36.0	60.0	72.0	120.0	180.0	204.0
P cm	25.0	25.0	25.0	25.0	25.0	25.0
X1 cm	4.3	4.3	4.3	4.3	4.3	4.3

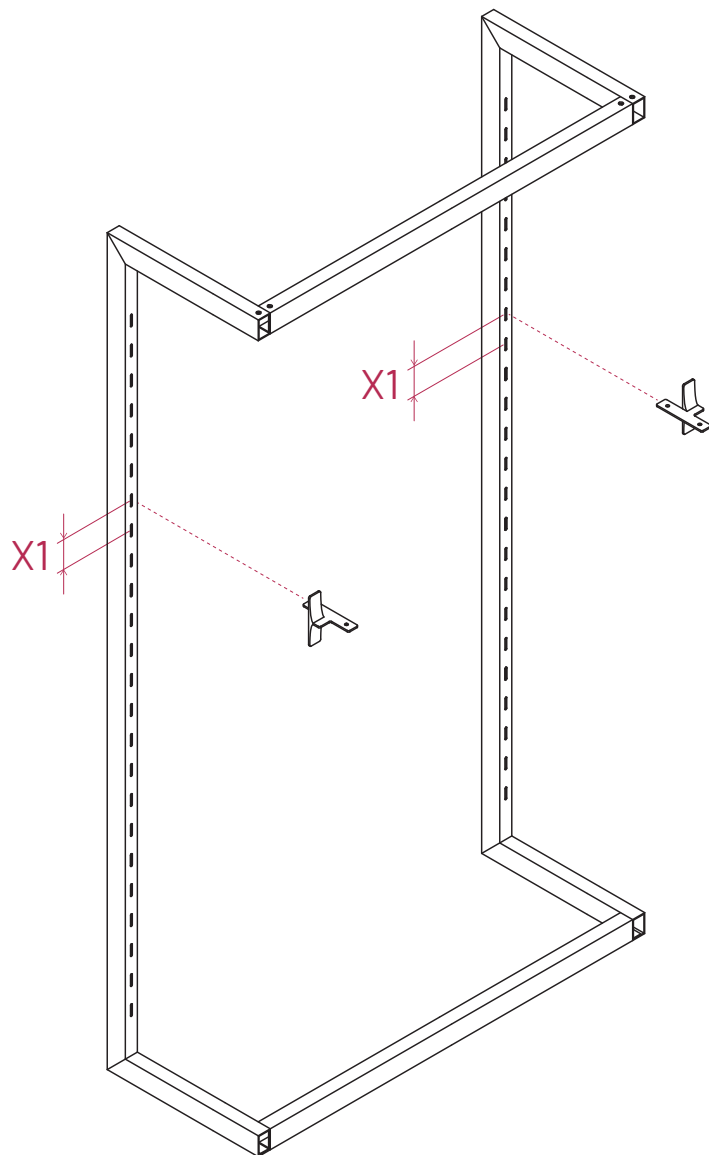

FINITURE / FINISHES

 Ghisa / Cast iron

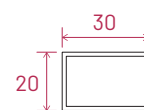

u = mm

Reggimensola / Shelf support

Materiale / Materials
Zama / Zamak

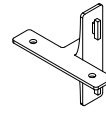
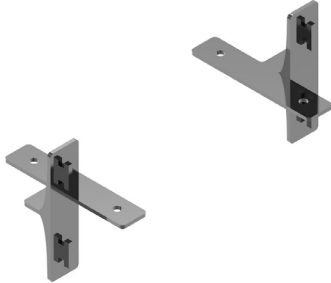

STEP-SH

Kg.	0.1
L cm	3.4
H cm	7.1
P cm	7.6

FINITURE / FINISHES

 Ghisa / Cast iron

Mensola / Shelf

Materiale / Materials
Ferro / Iron

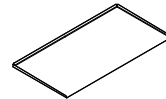
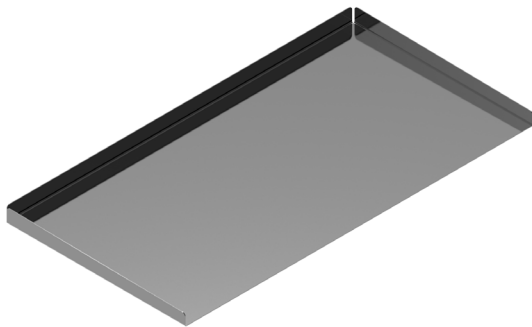

STEP-600

Kg.	1.7
L cm	60.0
H cm	2.5
P cm	31.0

FINITURE / FINISHES

 Ghisa / Cast iron

Mensola / Shelf

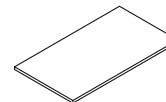

Materiale / Materials
Legno / Wood



SW/60x31

Kg.	1.9
L cm	60.0
H cm	1.8
P cm	31.0

FINITURE / FINISHES

 Rovere / Durmast
 Noce / Walnut

Step

Scheda di montaggio
Assembly instructions

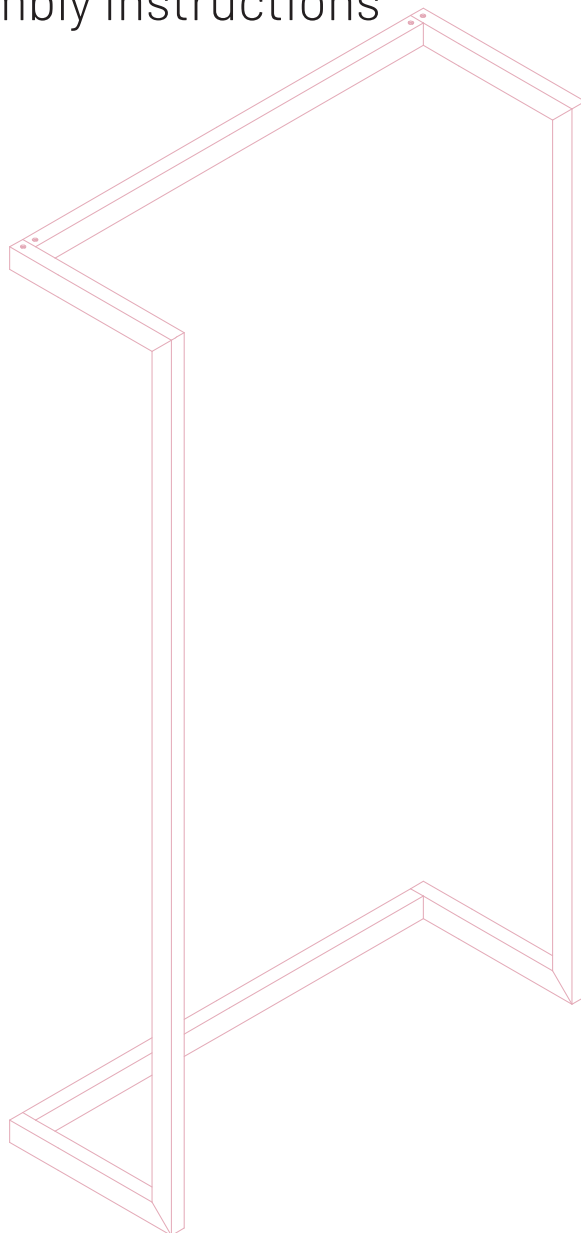

Damiano Latini s.r.l.
Via Tangenziale 14/16,
62010 - Montecosaro (MC)
email: info@damianolatini.it
P.IVA 01410060436

Step

Materiale | Materials

A Vite da muro + tassello
Self-tapping screws +
wall plug
N.2 pcs (5 x 50 mm)

B Vite per ferro
Metric screws
N.8 pcs (4 x 10 mm)

Connettore
Connector
N.4 pcs

Squadrette da muro
Wall brackets
N.2 pcs

Squadrette da legno
Wood brackets
N.4 pcs

Cornice in ferro
Iron frame
N.2 pcs

Strumenti necessari | Required tools

Trapano | Drill



Cacciavite a croce |
Phillips Screwdriver

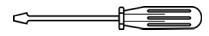

Chiave a brugola | Allen
key



Punta trapano | Drill bit



1 Segnare le distanze | Draw distances

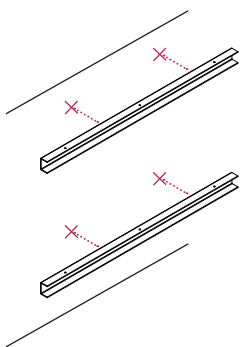

Prendere le distanze sul
muro.

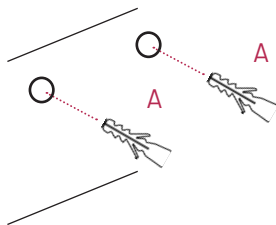

2 Fissare a muro | Fix into the wall

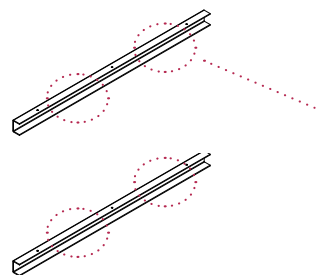

Montare le squadrette per
le mensole e fissarle con le
viti di tipo B.

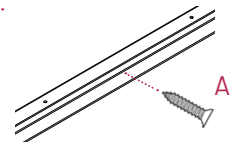

3 Posizionare ed avvitare | Fit and screw

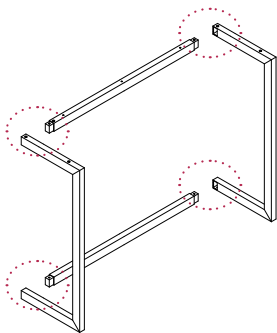

Bloccare con le viti.
Lock with screws.

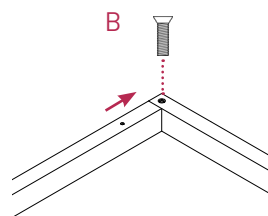

4 Fissare al supporto | Fix to support

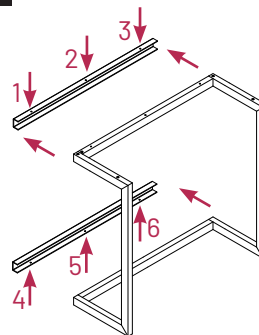

Bloccare con le viti.
Lock with screws.

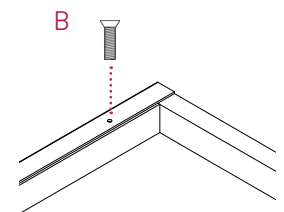

5 Montare le mensole | Place the shelves

