

Outline

Scheda tecnica
Technical sheet

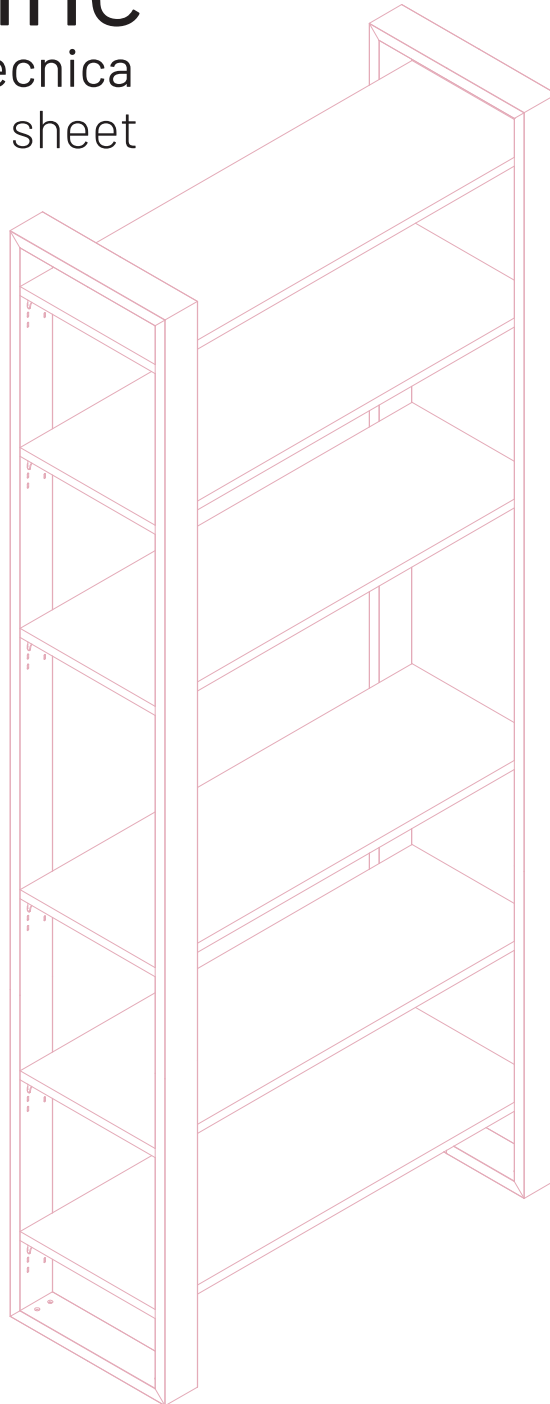

Damiano Latini s.r.l.
Via Tangenziale 14/16,
62010 - Montecosaro (MC)
email: info@damianolatini.it
P.IVA 01410060436



Outline

Semplice e versatile, Outline è la libreria in legno modulare adatta ad arredare gli ambienti della casa. Le cornici in metallo appoggiate a terra alloggiavano mensole in legno, regolabili in altezza, che permettono di ospitare in maniera pratica oggetti dalle altezze più varie. Componibile secondo diversi moduli, è il complemento ideale per il soggiorno ma funge anche da comoda libreria per gli altri ambienti della casa.

Simple and adaptable, Outline is the modular wooden bookcase suitable in furnishing any home. The metal frames, resting on the ground, hold wooden shelves, adjustable in height, which allow to put different objects in a practical way. Its composing system makes it the ideal furniture for the living room. It can be convenient bookcase for other rooms too.



OUTLINE





Materiale / Materials
Alluminio / Aluminium

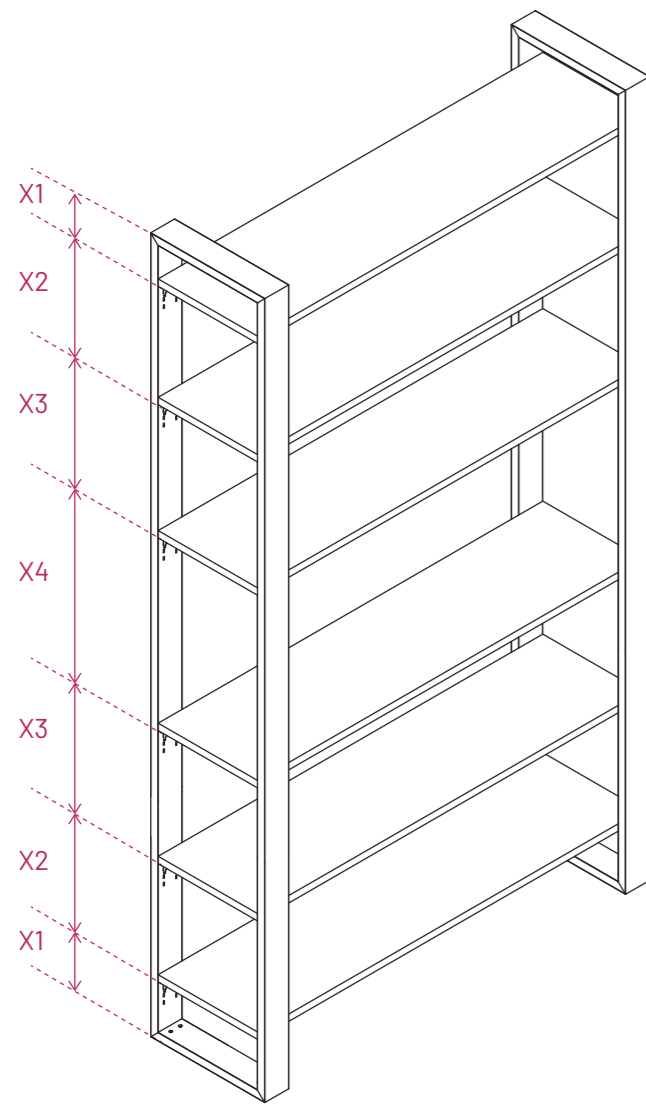

	LIBOUT/M	LIBOUT/SH
Kg.	6.24	0.03
L cm	7.5	4.0
H cm (min-max)	216.0 - 217.0	3.7
P cm	35.6	3.2
X1 cm	19.0	
X2 cm	32.0	
X3 cm	36.0	
X4 cm	52.0	



FINITURE / FINISHES

-  Titanio / Titanium
-  Nero / Black
-  Bronzo / Bronze
-  Bianco / White

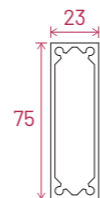

u = mm

Accessori / Accessories

Mensola legno 60
Wooden shelf 60

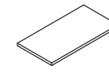

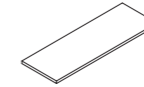

Mensola legno 90
Wooden shelf 90



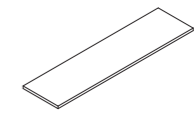

Mensola legno 120
Wooden shelf 120









Legno laccato / Lacquered wood
Finiture mensole
Shelves finishes

-  Nero opaco / Matte black
-  Bianco opaco / Matte white
-  Grigio opaco / Matte grey

Legno melaminico / Melamine wood
Finiture mensole
Shelves finishes

-  Rovere ortisei / Ortisei durmast
-  Noce tundra / Tundra walnut

Legno impiallacciato / Veneered wood
Finiture mensole
Shelves finishes

-  Noce canaletto / Canaletto walnut
-  Rovere spaccato / Split durmast
-  Rovere dove / Dove durmast
-  Rovere dark / Dark durmast
-  Frassino bianco / White ash
-  Frassino nero / Black ash



PIEDINI DI REGOLAZIONE

Grazie ai piedini di regolazione i montanti possono essere allineati e messi in tensione in modo solido e sicuro in tutta semplicità. Utilizzando i piedini di regolazione è possibile regolare l'altezza fino a 5 cm.

ADJUSTING FEET

Thanks to the adjusting feet, you can easily align the pillars in a solid and safe manner. Using the adjustment feet you can adjust the height up to 5 cm.



MODULARE

Una semplicità architettonica che assicura al progetto un'eccezionale versatilità, con la possibilità di realizzare composizioni anche di ampie dimensioni, in assoluta sicurezza. Affiancando più moduli è possibile comporre infinite soluzioni.

MODULAR

An architectural simplicity that assures the project an exceptional versatility, with the opportunity of creating compositions of even greater dimensions, in absolute safety. By joining multiple modules, it is possible to make infinite solutions.

Outline

Scheda di montaggio
Assembly instructions

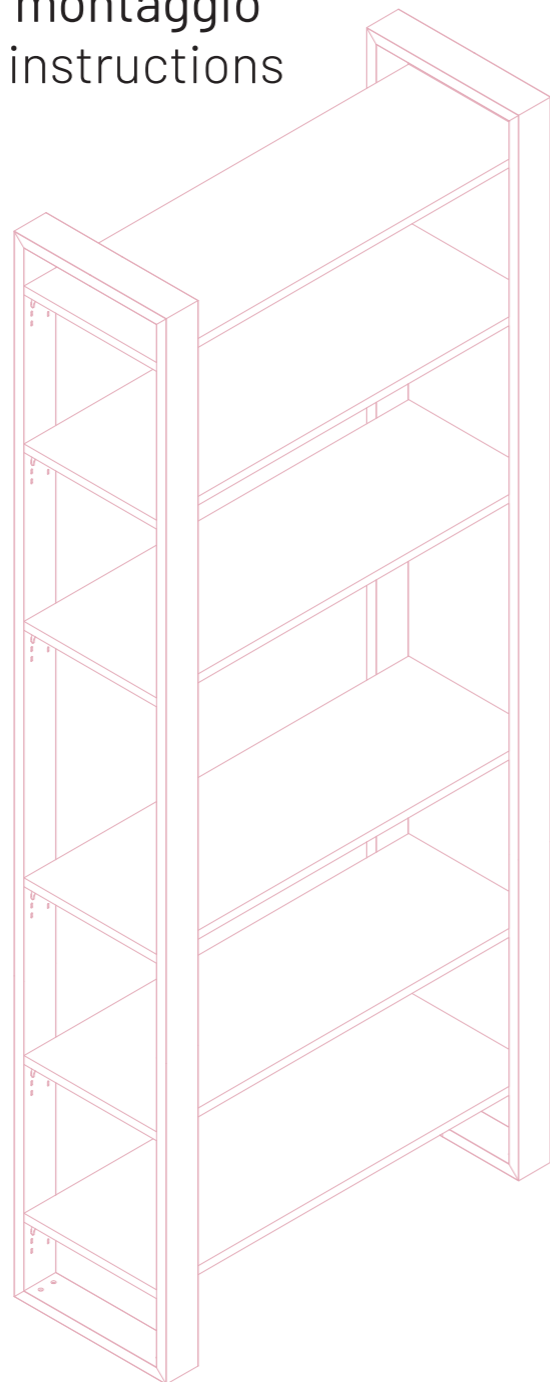



Damiano Latini s.r.l.
Via Tangenziale 14/16,
62010 - Montecosaro (MC)
email: info@damianolatini.it
P.IVA 01410060436

Outline

Materiale | Materials

A  Vite da muro + tassello
Self-tapping screws +
wall plug
N.4 pcs (4,5 x 40 mm)

 Selle di appoggio
Saddles holder
N.24 pcs

B  Vite per legno
Self-tapping
screws for wood
N.48 pcs (4 x 16 mm)

 Profilo con piedi
Aluminium profile
with feet
N.2 pcs

 Distanziale per muro
Wall spacer
N.4 pcs (14 x 10 mm)

Strumenti necessari | Required tools

Trapano | Drill



Cacciavite a croce |
Phillips Screwdriver



Punta trapano | Drill bit



1 Preparare i profili | Set up the profiles

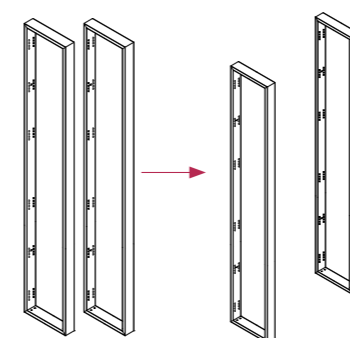

Prendere i profili ed
allinearli frontalmente.
Set up the profiles and
place them parallel
each other.

2 Prendere le distanze | Draw the distances

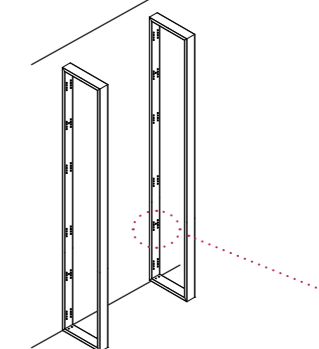

Prendere le distanze sul muro.
Draw distances on the wall.

3 Fissare a muro | Fix on the wall with support

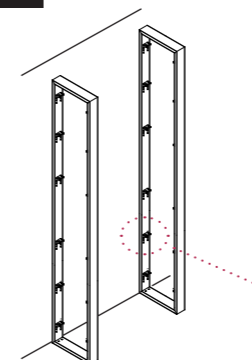

Bucare il muro e fissare il profilo con
il supporto.
Put the supports on the designed
holes and fix with rubber hammer.

4 Agganciare le selle | Fix the supports

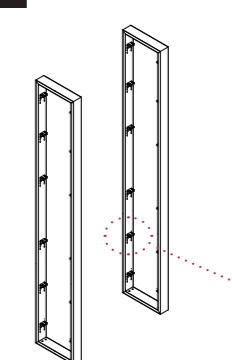

Infilare le selle negli appositi fori.
Put the supports on the designed
holes.

5 Posizionare le mensole | Fit shelves

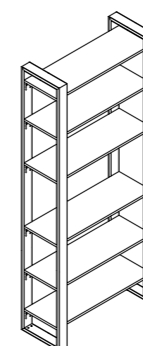

Posizionare le mensole sopra le selle.
Put shelves on supports.

6 Fissare le mensole | Fix shelves

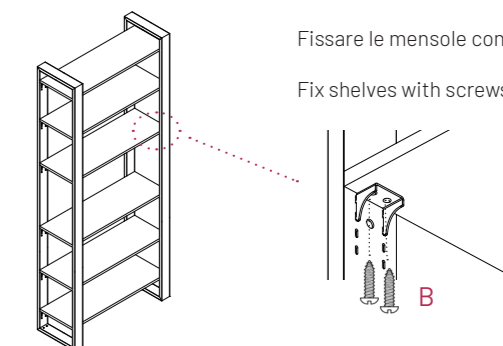

Fissare le mensole con le viti.
Fix shelves with screws.

