

---

# Horizon

Scheda tecnica  
Technical sheet

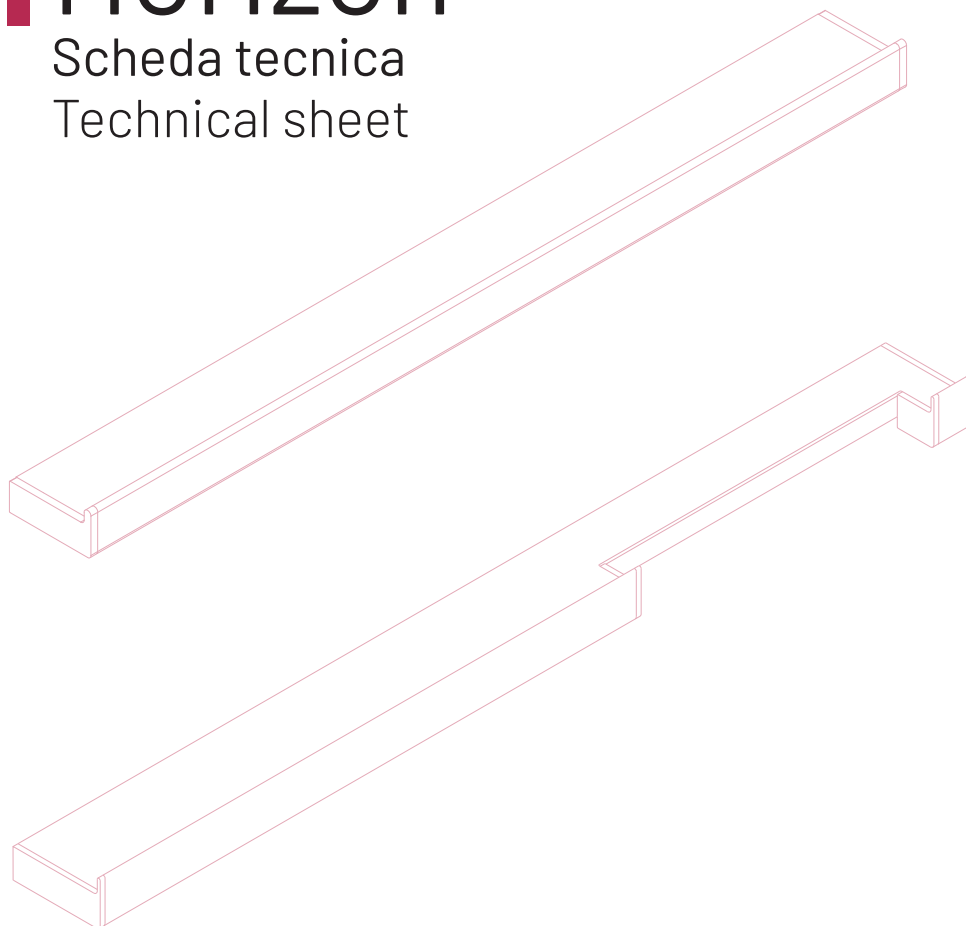

Damiano Latini s.r.l.  
Via Tangenziale 14/16,  
62010 - Montecosaro (MC)  
email: [info@damianolatini.it](mailto:info@damianolatini.it)  
P.IVA 01410060436

---



White salt shaker

Amber jar

Two glass salt and pepper shakers

Roll of paper towels

Three black mugs and two amber jars

French press coffee maker

Two wooden spoons hanging from the shelf



## HORIZON

Piccolo e compatto, Horizon organizza in modo pratico e razionale tutti gli strumenti da lavoro indispensabili in cucina: coltelli, utensili, spezie, ricettari, rotolo assorbente. Con la sua barra in alluminio disponibile in diverse finiture, si integra perfettamente sia agli ambienti di gusto più classico che a quelli moderni e minimali, rendendo agevole ogni tuo gesto e più piacevole la tua quotidianità in cucina.

Small and compact. Horizon organizes practically and efficiently all the indispensable work tools in the kitchen: knife, utensils, spices, books, kitchen rolls. Thanks to its aluminium bar available in different finishes, it fits perfectly into either classic or modern furnished spaces. It will help during your everyday life in the kitchen and it will make every moment more enjoyable.





# HORIZON

Materiale / Materials  
Alluminio / Aluminium

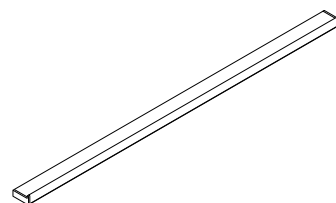
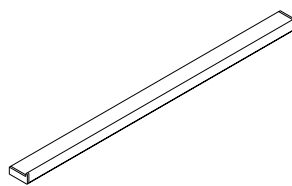
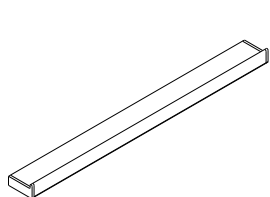

	HORIZON 600	HORIZON 900	HORIZON 1200
Kg.	0.8	1.2	1.5
L cm	61.0	91.0	121.0
H cm	3.0	3.0	3.0
P cm	6.0	6.0	6.0

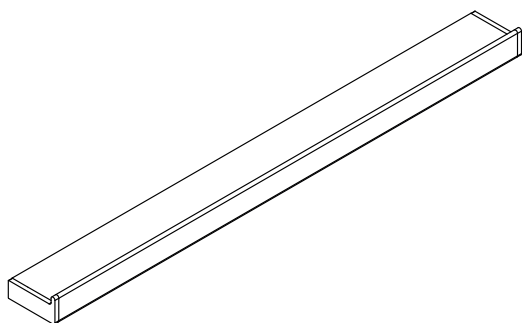

## FINITURE / FINISHES

-  Ghisa / Cast iron
-  Anodizzato spazzolato / Brushed anodized
-  Nero / Black
-  Bianco / White
-  Oro antico / Antique gold
-  Bronzo / Bronze

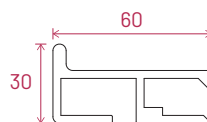

u = mm

## Accessori / Accessories

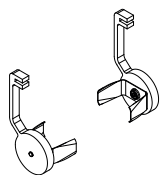

Portarotolo  
Roll holder

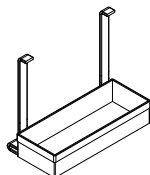

Porta spugne  
Sponges holder



Porta dispenser  
Soap dispenser holder

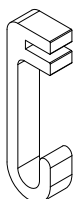

Gancio  
Hook

# HORIZON T

Materiale / Materials  
Alluminio / Aluminium

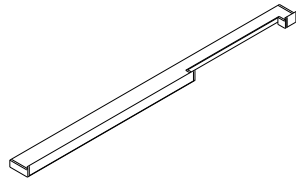

HORIZON 900 T

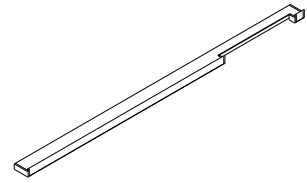

HORIZON 1200 T

Kg.	1.8	2.1
L cm	91.0	121.0
H cm	3.0	3.0
P cm	6.0	6.0

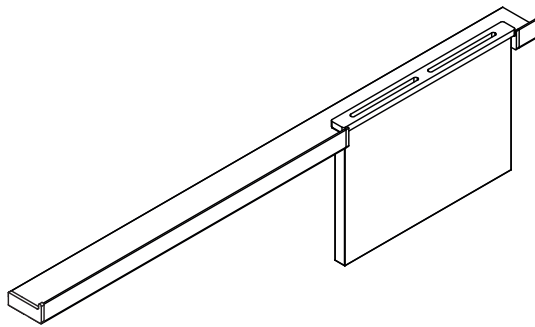

## FINITURE / FINISHES

-  Ghisa / Cast iron
-  Anodizzato spazzolato / Brushed anodized
-  Nero / Black
-  Bianco / White
-  Oro antico / Antique gold
-  Bronzo / Bronze

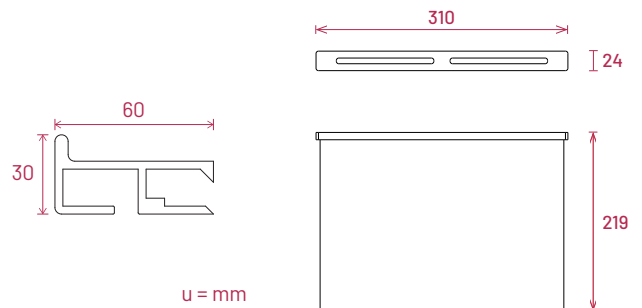

## Accessori / Accessories

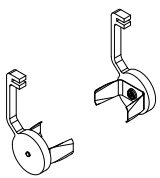

Portarotolo  
Roll holder

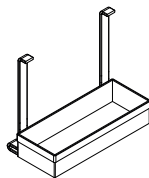

Porta spugne  
Sponges holder

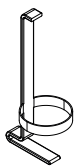

Porta dispenser  
Soap dispenser holder

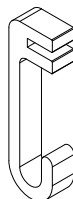

Gancio  
Hook

---

# Horizon

Scheda di montaggio  
Assembly instructions

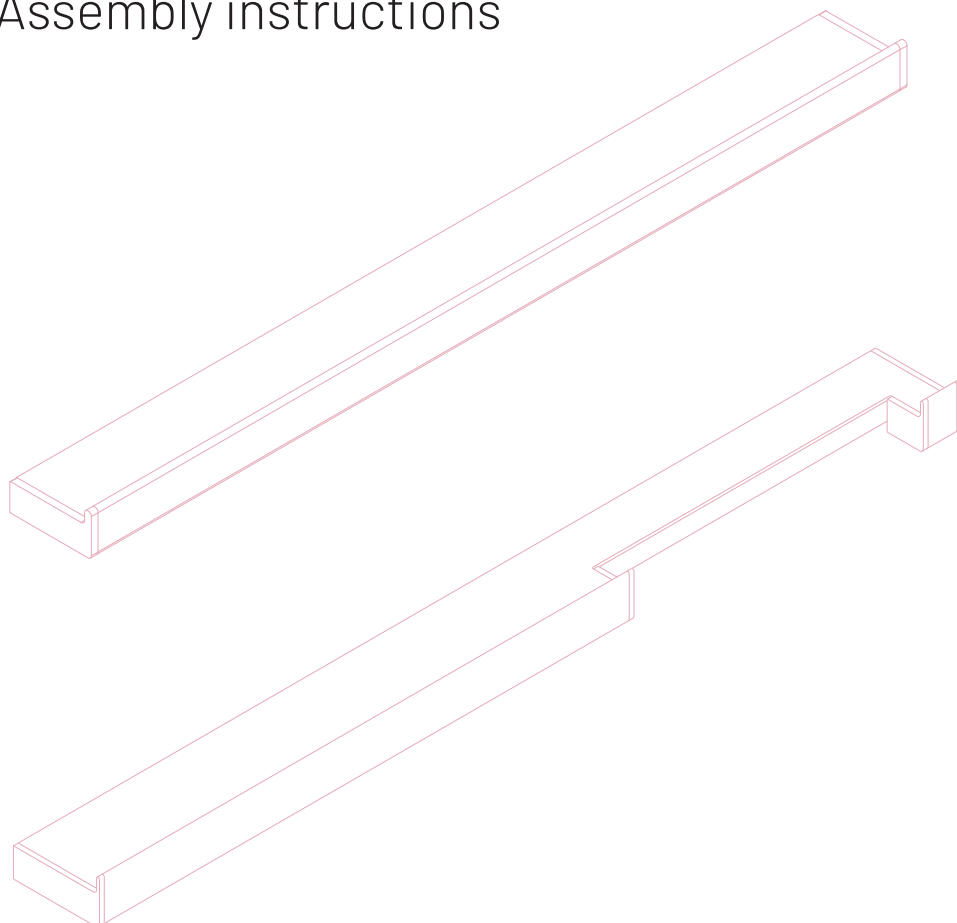

**Damiano Latini s.r.l.**  
Via Tangenziale 14/16,  
62010 - Montecosaro (MC)  
email: [info@damianolatini.it](mailto:info@damianolatini.it)  
P.IVA 01410060436



# Horizon

## Materiale | Materials

**A** Vite da muro + tassello  
Self-tapping screws +  
wall plug  
N.4 pcs (4 x 25 mm)

**B** Grani a testa esagonale  
Hexagonal head grains  
N.2 pcs (4 x 16 mm)

Attaccaglia per muro  
Wall holder profile  
N.2 pcs (14 x 10 mm)

Elementi di chiusura  
Closing element  
N.2 pcs

Profilo in alluminio  
Aluminium profile  
N.1 pcs

## Strumenti necessari | Required tools

Trapano | Drill



Cacciavite a croce |  
Phillips Screwdriver

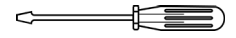

Punta trapano | Drill bit



Chiave a brugola |  
Allen key



This is in the box!

### 1 Prendere le misure | Mark measures

Segnare a muro dove forare.

Mark on the wall where to drill.

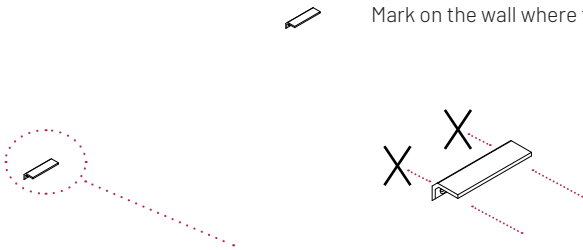

### 2 Forare il muro | Drill the wall

Forare ed inserire il  
supporto.

Drill and insert wall plug.

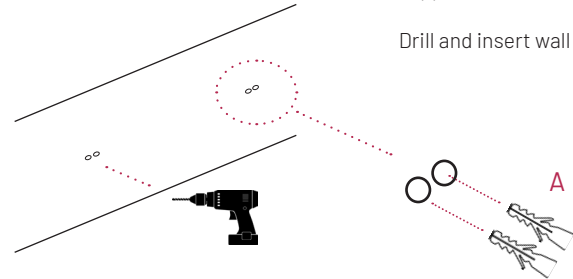

### 3 Avvitare l'attaccaglia | Screw the hanger

Avvitare l'attaccaglia al muro nei fori  
precedentemente fatti.

Screw the hanger to the wall in the  
holes previously made.

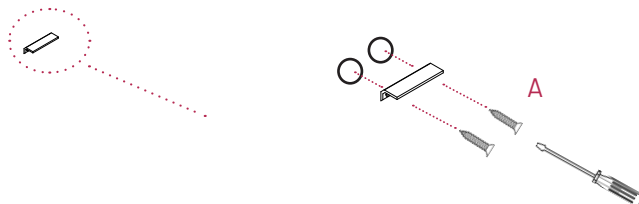

### 4 Avvitare il tutto | Screw the whole

Fissare il profilo con i grani.

Fix the aluminium profile  
with grains.

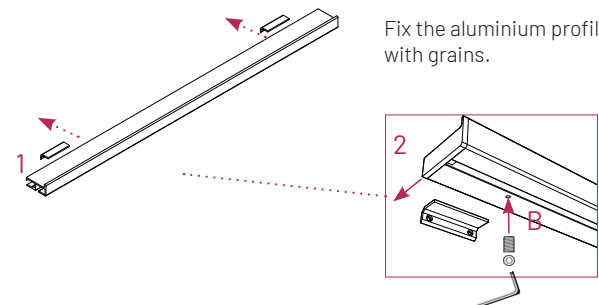

### 5 Montare i tappi | Fit closing element





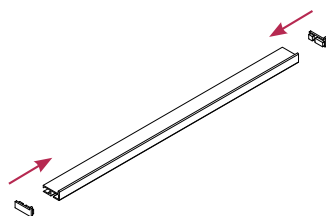

Incastrare gli elementi di chiusura  
alle estremità.

Fit closing elements to edges.



# Horizon T

## Materiale | Materials

<p><b>A</b></p>  <p>Vite da muro + tassello Self-tapping screws + wall plug N.4 pcs (4 x 35 mm)</p>	<p><b>A</b></p>  <p><b>B</b></p> 	<p>Elementi di chiusura A e B Closing element type A and B N.4 pcs</p>
<p><b>B</b></p>  <p>Grani a testa esagonale Hexagonal head grains N.2 pcs (4 x 16 mm)</p>		<p>Tagliere Knife block N.1 pcs</p>
 <p>Profilo in alluminio Aluminium profile N.1 pcs</p>		<p>Attaccaglia per muro Wall holder profile N.2 pcs (14 x 10 mm)</p>

## Strumenti necessari | Required tools

Trapano | Drill



Cacciavite a croce | Phillips Screwdriver

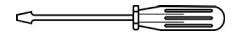

Chiave a brugola | Allen key



Punta trapano | Drill bit



This is in the box!

### 1 Prendere le misure | Mark measures

Segnare a muro dove forare.

Mark on the wall where to drill.

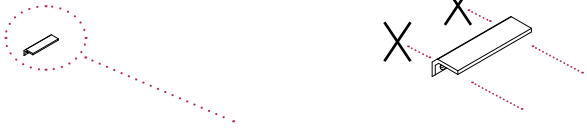

### 2 Forare il muro | Drill the wall

Forare ed inserire il supporto.

Drill and insert wall plug.

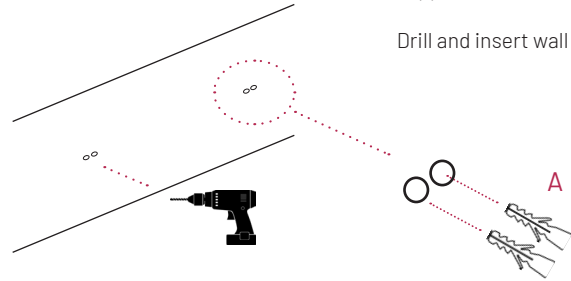

### 3 Avvitare l'attaccaglia | Screw the hanger

Avvitare l'attaccaglia al muro nei fori precedentemente fatti.

Screw the hanger to the wall in the holes previously made.

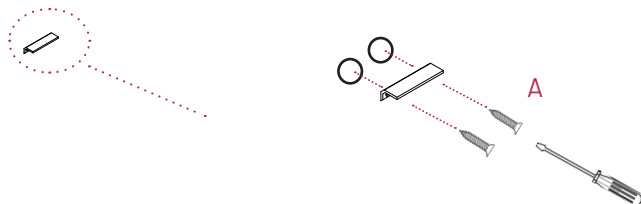

### 4 Avvitare alla parete | Screw into the wall

Fissare il profilo con i grani.

Fix the aluminium profile with grains.

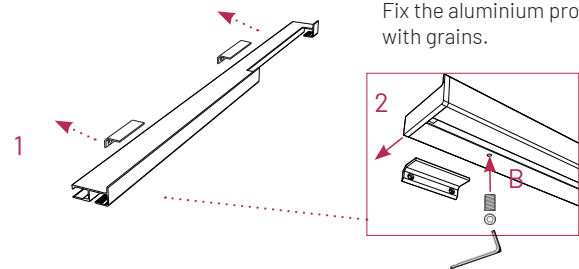

### 5 Montare i tappi A | Fit closing element

Incastrare gli elementi di chiusura alle estremità.

Fit closing elements (A) to edges.

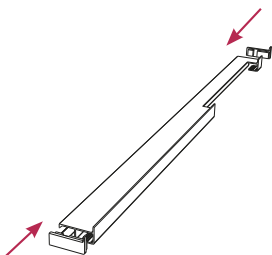

### 6 Montare i tappi B | Fit closing element

Incastrare gli elementi di chiusura alle estremità.

Fit closing elements (B) to edges.

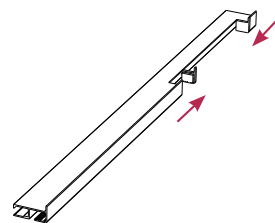

DAMIANO  
LATINI