

---

# Caos

Scheda tecnica  
Technical sheet

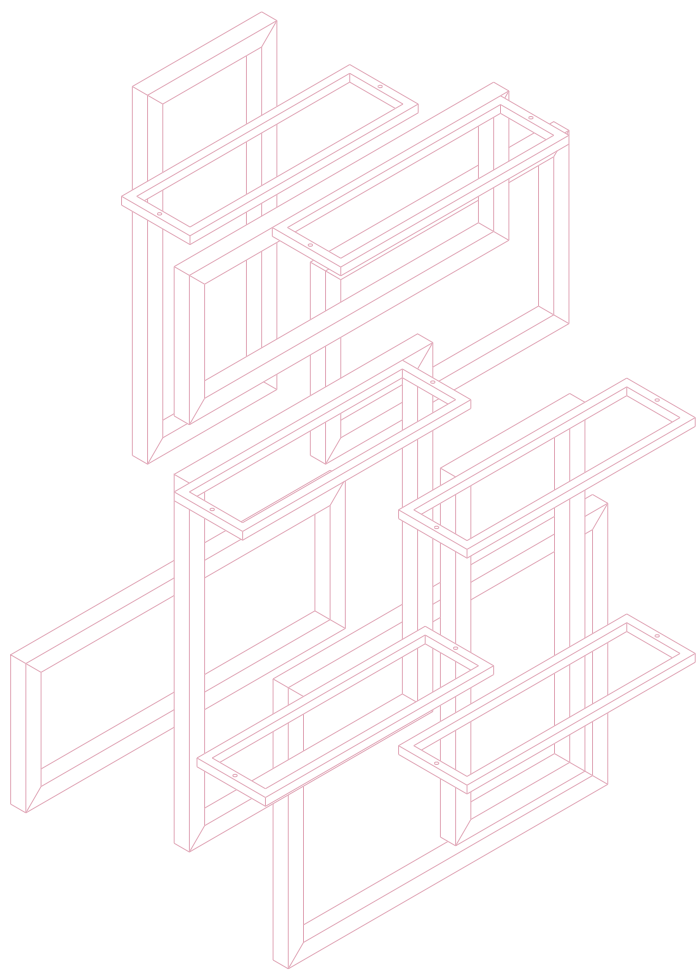

Damiano Latini s.r.l.  
Via Tangenziale 14/16,  
62010 - Montecosaro (MC)  
email: [info@damianolatini.it](mailto:info@damianolatini.it)  
P.IVA 01410060436





## CAOS

Caos è un moderno portabottiglie da parete dal design elegante e innovativo. Formato da un'unica unità ripetibile potenzialmente all'infinito, Caos è un intreccio di linee orizzontali e verticali volte a creare un disegno astratto. La struttura modulare consente sviluppare il portabottiglie in orizzontale o in verticale e di arredare pareti di qualsiasi dimensioni. In alternativa, Caos può essere dotato di mensole in legno da utilizzare come porta oggetti e diventare così un elegante complemento d'arredo per il soggiorno.

Caos is a modern wall bottle holder with an elegant and innovative design. Formed by a single unit that can be repeated to infinity, Caos is a network of horizontal and vertical lines designed to create an abstract design. The modular structure allows the bottle holder to be developed horizontally or vertically and to decorate walls of any size. Alternatively, Caos can be equipped with wooden shelves to be used as an object holder and thus become an elegant piece of furniture for the living room.





# CAOS

Materiale / Materials  
Ferro / Iron

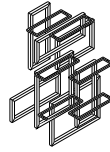

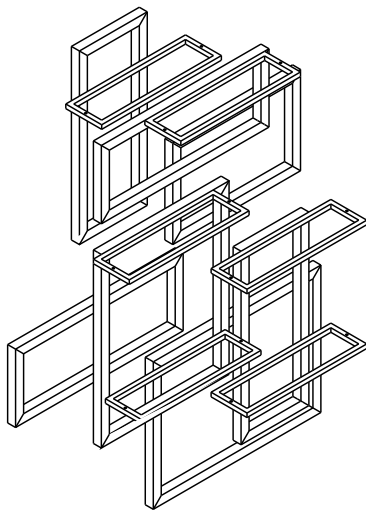

CAOS	
Kg.	13.0
L cm	77.0
H cm	108.5
P cm	13.0



## FINITURE / FINISHES

**Metallo / Metal**

-  Nero / Black
-  Bronzo / Bronze

# Mensola / Shelf

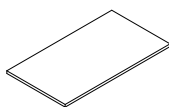

Materiale / Materials  
Legno / Wood





CAOS-SHELF	
Kg.	1.6
L cm	32.0
H cm	1.8
P cm	15.0

## FINITURE / FINISHES







**Legno melaminico / Melamine wood**

-  Rovere ortisei / Ortisei durmast
-  Noce tundra / Tundra walnut

## Legno laccato / Lacquered wood

-  Nero opaco / Matte black
-  Bianco opaco / Matte white
-  Grigio opaco / Matte grey

## Legno impiallacciato / Veneered woods

-  Rovere spaccato / Split durmast
-  Noce canaletto / Canaletto walnut
-  Rovere dove / Dove durmast
-  Rovere dark / Dark durmast
-  Frassino bianco / White ash
-  Frassino nero / Black ash

## Note per le composizioni / Configuration notes

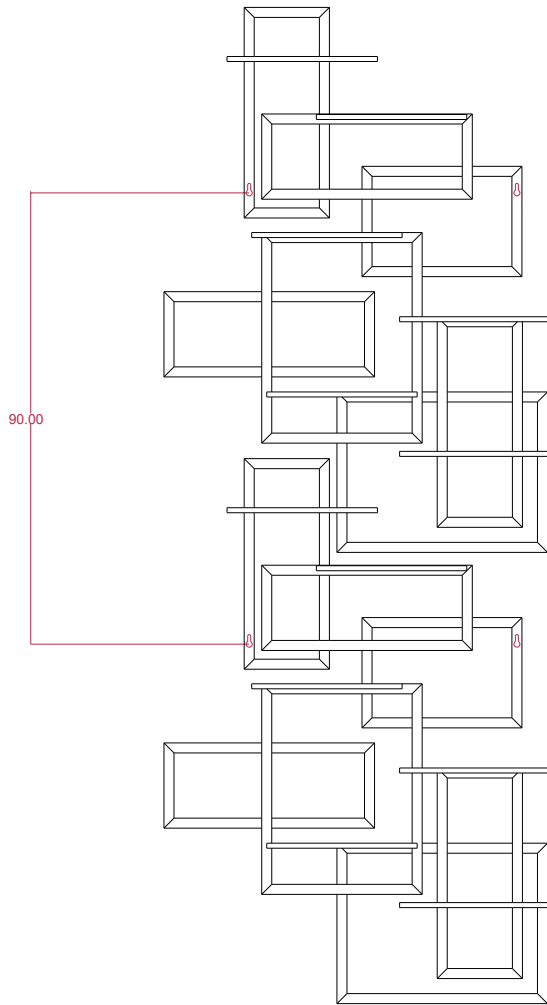

Grazie alla struttura modulare, Caos si può assemblare utilizzando una o più unità a seconda delle preferenze. L'importante è rispettare la distanza di interasse tra le singole unità di 90 cm se sono disposte una sopra all'altra.

Thanks to its modular structure, you can choose to build Caos with one or more units according to your needs. However be aware to keep the right interax distance among units: 90 cm if you place one above the other.

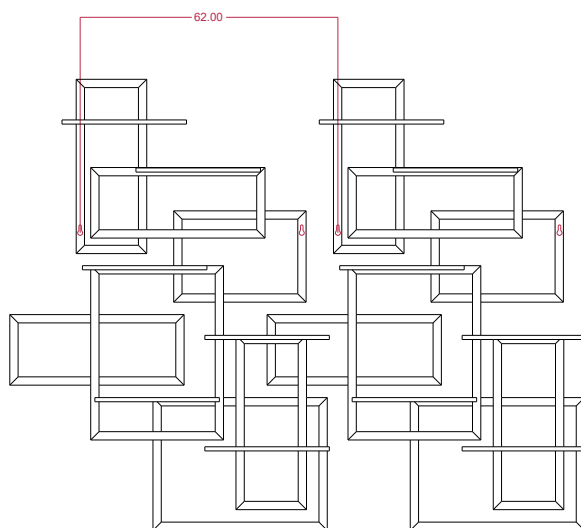

## 2

Mantenere un interasse tra le due strutture di 62 cm se le strutture sono poste l'una di fianco all'altra.

Maintain a distance between the two structures of 62 cm if the structures are placed side by side.

---

# Caos

Scheda di montaggio  
Assembly instructions

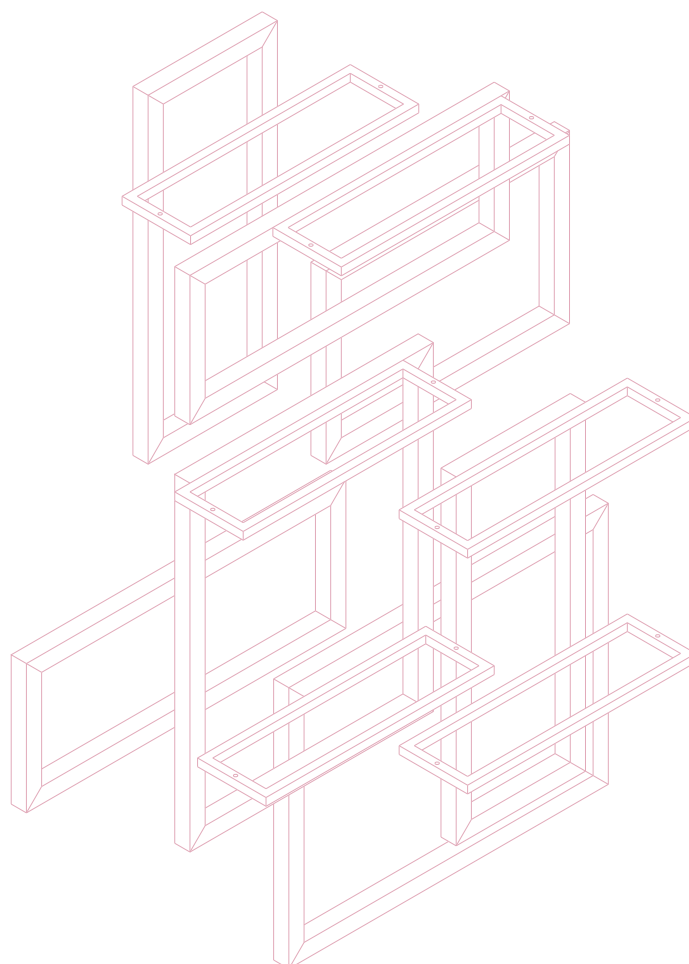



Damiano Latini s.r.l.  
Via Tangenziale 14/16,  
62010 - Montecosaro (MC)  
email: [info@damianolatini.it](mailto:info@damianolatini.it)  
P.IVA 01410060436

---



# Caos

## Materiale | Materials

- A**  Vite da muro + tassello  
Self-tapping screws +  
wall plug  
N.2 pcs (5 x 50 mm)
- B**  Vite per mensole  
Self-tapping screw  
N.8 pcs (4 x 20 mm)

## Strumenti necessari | Required tools

Trapano | Drill



Cacciavite a croce |  
Phillips Screwdriver

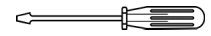

Punta trapano | Drill bit



Livella | Level



### 1 Prendere le misure | Measure distances

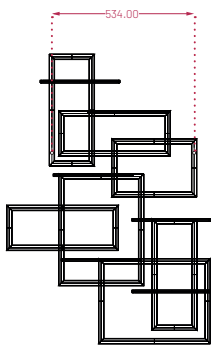

Segnare dove forare per i tasselli a parete: la distanza tra i centri dei fori deve essere di 53.4 cm.

Drawing where to drill the wall: the holes center distance must be 53.4 cm.

### 2 Forare il muro | Drill the wall

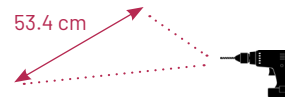

Forare il muro.

Drill the wall.

### 3 Agganciare a parete | Hang on the wall

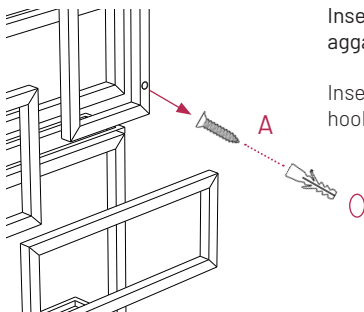

Inserire il supporto nel muro e agganciare la struttura.

Insert the plug in the wall and hook the structure.

### 4 Completare le forature | Finish the holes

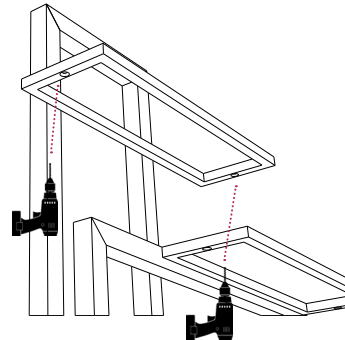

Con l'utilizzo di un trapano, completare i prefori per le mensole posti sotto ad ogni portabottiglia.

With the use of a drill, complete the holes for the shelves under each bottle holder.

### 5 Avvitare le mensole | Screw the shelves

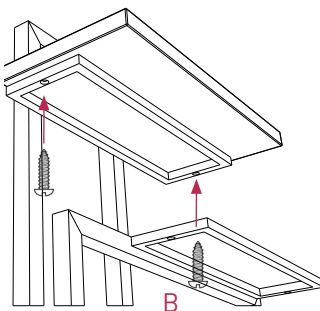

Avvitare le mensole alla struttura tramite le viti truciolari (B).

Screw the shelves to the structure using the chipboard screws.