

# Sherpa **WINCHES**

*[www.sherpa4x4.com.au](http://www.sherpa4x4.com.au) | [info@sherpa4x4.com.au](mailto:info@sherpa4x4.com.au)*

## **SHERPA 4x4 WINCH OWNER'S MANUAL**

# PLEASE READ

## WARNING!

Your winch has a duty cycle and should not be run continuously without allowing time to cool down. The higher the load, the higher the current and heat produced at the motor.

Remember to monitor the temperature of the winch motors and cabling. As a rule of thumb, when winching at high loads, do not winch for longer than 30 seconds, then follow by a 10 minute cool down period. This will also allow your battery to rest and stabilise.

Overheating your winch motor will reduce its pulling power and may lead to premature failure.

# NOTE – Your winch performance reduces with drum layers

| Pulling Capacity by Layer | Winch Model |              |             |              |             |              |             |              |             |              |
|---------------------------|-------------|--------------|-------------|--------------|-------------|--------------|-------------|--------------|-------------|--------------|
|                           | 25,000 lb   |              | 17,000 lb   |              | 12,000 lb   |              | 10,000 lb   |              | 9,500 lb    |              |
|                           | Rating (lb) | Capacity (m) | Rating (lb) | Capacity (m) | Rating (lb) | Capacity (m) | Rating (lb) | Capacity (m) | Rating (lb) | Capacity (m) |
| 1st                       | 25,000      | 4.3          | 17,000      | 4.3          | 12,500      | 4.3          | 10,000      | 4.4          | 9,500       | 6.2          |
| 2nd                       | 19,000      | 10.1         | 12,730      | 11.5         | 9,520       | 11.5         | 7,580       | 11.4         | 8,260       | 14.2         |
| 3rd                       | 15,320      | 17.4         | 10,570      | 19           | 7,890       | 19           | 6,310       | 19.8         | 7,040       | 23.5         |
| 4th                       | 12,840      | 26           | 9,040       | 29           | 6,740       | 28           | 5,400       | 28           | 6,130       | 28           |
| 5th                       | 11,040      | 30           | 8,230       | 45           |             |              |             |              |             |              |

**Plan your recovery to get the most out of your winch**

## OPERATION WARNINGS

**WARNING!** Please read and abide by the Operation Warnings to ensure personal safety and the safety of others. Improper operation may lead to personal injury and equipment damage. Read the following carefully before you attempt to operate your winch and please retain for future reference.

- Uneven spooling of cable/rope while pulling a load can cause problems. If this happens, reverse the winch to relieve the load and move your anchor point further to the centre of the vehicle. After the recovery is complete, you can un-spool the cable/rope and rewind for a neat layer of cable.
- Store the winch hand controller inside your vehicle where it will not be damaged or wet. Inspect it before use.
- Always connect the controller with the clutch disengaged. **DO NOT** engage the clutch with the motor running or under load.
- Avoid sudden direction changes of the winch rotation whilst winching. Allow the winch to come to a stop before changing from 'winch out' to 'winch in' and vice versa.
- Never loop the hook back onto the cable or rope. This will cause kinking or fraying. Always use a sling, tree trunk protector or chain of suitable strength and rating.
- Observe your winch at all times when performing a winch recovery and stand at a safe distance. Stop the recovery every few meters to assure the cable/rope is not piling up on one end of the winch. Jamming the cable/rope can damage your winch and cable.
- **DO NOT** attach tow or recovery hooks to winch mounting apparatus. They must be attached to your vehicle frame.
- When performing a recovery with a snatch block, always maintain a direct line pull to the centre of the winch. Ensure the hook is attached to the chassis of the vehicle.
- Ensure rated "D" or Bow shackles are used in conjunction with an approved tree trunk protector to provide a safe anchor point.
- When extending the winch cable, ensure that at least five (5) wraps of cable/rope remain on the drum at all times. Failure to do this could result in the cable/rope parting from the drum under load. Serious personal injury or property damage may result.

**WARNING!** If replacing steel wire rope with any kind of synthetic rope, make sure the rope can withstand the maximum capacity of your winch.

- Cable winches are provided with a red marking to identify that five (5) cable wraps remain on the winch drum. No recovery should be attempted beyond this marking.
- Winch dampeners should always be used while winching.
- Apply blocks behind the wheels when winching vehicles on an incline.

## **Battery:**

- Be sure that the battery is in good condition.
- Always wear eye protection when working around a battery.
- Ensure the engine is running when using the winch to avoid flattening the battery.

## **Winch Cable:**

- Be sure that the cable is in good condition and is attached to the winch properly.
- **DO NOT** use the winch if the cable is frayed.
- **DO NOT** move the vehicle to pull a load.
- **DO NOT** replace the cable with a cable of lower strength.

The life of the cable is directly related to the use and care it receives. Following its first and subsequent uses, a cable must be wound on to the drum under a load of at least 500lbs (230kgs) otherwise the outer wraps will draw into the inner wraps and severely damage the cable during winching. The first winch use should be a familiarisation run while in a relaxed, non recovery situation. Spool out the cable until the red cable mark appears (around five wraps on the drum), and then rewind the cable onto the drum under a load of 500lbs (230kgs). Winching your vehicle up a slight incline is a good way to achieve this. This will slightly tension and stretch the cable and create a tight cable wrap around the drum. Failure to do so may result in cable damage and reduction in cable life.

- **DO NOT** attempt to exceed the pulling limits of this winch.
- **DO NOT** drive your vehicle to assist the winch in any way. Vehicle movement in combination with winch operation may overload the cable/rope or winch by causing damaging shock loads.
- Shock loads when winching are dangerous. A shock load occurs when an increased force is suddenly applied to the cable. A vehicle rolling back on a slack cable may induce a damaging shock load.
- These winches are for recovery use in vehicle, boat and non industrial applications.
- **NEVER** use the winch in hoisting applications.
- **DO NOT** use the winch to lift, support or transport personnel.
- **DO NOT** attempt to move the winch by lifting the clutch handle.

## WINCH INSTALLATION

### Mounting Your Winch

The winch is to be mounted into a suitable steel mounting frame using the 4 point foot mounting system in either a horizontal or vertical plane. Your winch should only ever be installed with the rope/cable winding onto the drum on the lower side, closest to the mounting bolts. Your winch is not designed or rated for the rope/cable winding onto the top of the drum near the cross member supports.

Ensure your winch rope or cable is wrapping onto the drum as per the arrow stickers on your winch. Typically, when looking at the vehicle front on, the winch motor will be installed on the left hand side of the vehicle. Installing your winch backwards will result in the winch brake failing to work.

It is very important that the winch is mounted on a flat surface so that the three sections (motor, cable drum and gear housing) are properly aligned. Before commencing installation, ensure the mounting facility being used is capable of withstanding the winches maximum rated capacity. The fitment of winches and / or a frontal protection systems may affect the triggering of SRS air bags. Check that the mounting system has been tested and approved for winch fitment in air bag equipped vehicles.

The winch should be secured to the mounting plate with the steel bolts and spring washers provided. The fairlead or hawse is to be mounted so as to guide the rope/cable onto the drum evenly.

Your winch tie rod bolts may be loose from transport. These bolts should only be removed one at a time so your winch holds together. Apply a drop of thread locker to each bolt and tighten.

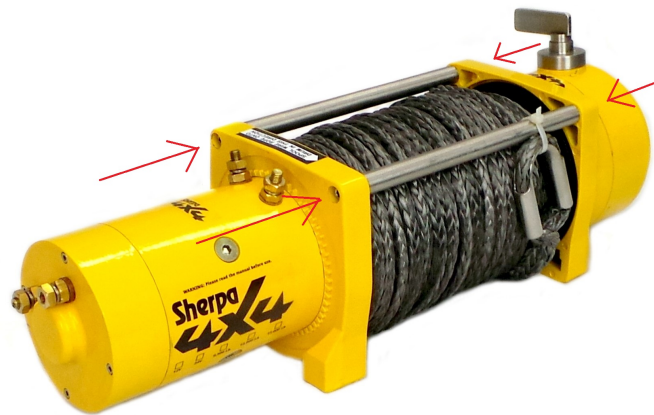

Winches are mounted in a high vibration environment. It is highly recommended both liquid thread locker and spring washers are used on all connections. All connections should be checked for tightness after 1,000km of travel.

## SPECIAL MOUNTING NOTES FOR 25,000 lb Winches

The Stallion 25,000lb winch can achieve forces which test the limits of the mounting bolts and winch foot construction. Care must be taken when mounting this winch to reduce the opportunity for a mounting related failure. The winch is capable of winching itself to catastrophic destruction if the below recommendations aren't followed.

The winch achieves its maximum recovery rating (25,000lb) when the first wrap is winding onto the drum. If you are planning on loading the winch to this limit, it is strongly suggested the winch be mounted such that the winch foot and bolts be in compression when winching with the mounting bolts in the horizontal plane.

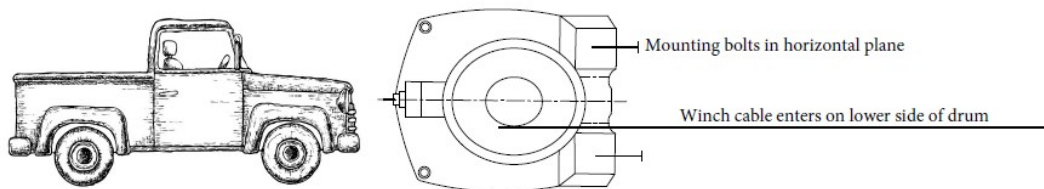

Mounting your winch with the bolts in the horizontal plane with the bolt heads facing the vehicle in front of you is the strongest mounting arrangement as it takes much of the winching force off the mounting bolts and winch foot mount. The rope/cable should enter the drum on the lower side of the drum in keeping with the direction labels on the winch. Ensure your mount is rated for the force that can be applied.

Mounting your winch with the bolts in the vertical plane and the bolt heads pointing to the road is acceptable, however, note, you will be operating near the limits of the bolts and the winch foot casting when fully loading the winch. Additional assist bolt locations have been added at the front of the winch to reduce the load on the lower foot and it is recommended these be used.

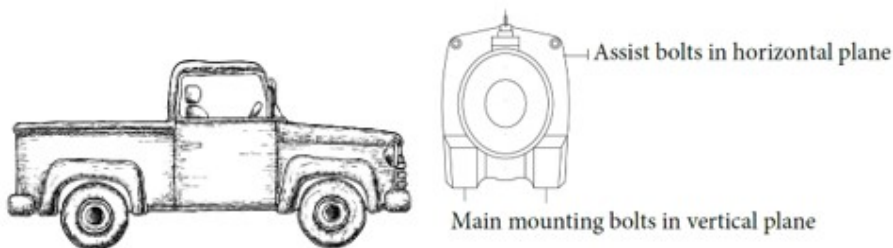

Unbalance in forces during winching can test the design limits of the winch mount and bolts. To limit the potential for a bolt shear failure, note the following;

- Think of the mounting plate as a knife wanting to cut through the bolts. A thicker plate is better and for the 25,000lb winch a minimum 6mm (1/4") plate should be used. Using a thicker 8mm (5/16") or 10mm (3/8") plate significantly increases the shear strength of the mounting bolts. Using a thicker plate only at the mounting holes achieves the same improvement and may be a lower weight option if the mounting plate is being fabricated especially for the winch. Never mount the winch to oversized or slotted holes as this will increase the likelihood of a bolt shear failure.
- Correct torque tightening of your bolts has greater importance when working at extreme loads. Check your bolt head and match the recommended torque setting to the table below.

| Bolt Grade | Torque (Nm) |
|------------|-------------|
| 8.8        | 44          |
| 10.9       | 62          |
| 12.9       | 75          |

- If you are planning on loading the winch to it's limit, it is recommended that the load be centred onto the drum to evenly distribute the force over all 4 mounting bolts which are under a high shear stress. Using a hawse or fairlead helps to achieve this. Uneven loading has potential to over stress the mounting bolts when in shear.



## Mount the Control/Solenoid Box

Find a suitable location for your control box to sit within cable distance from your winch motor.

Open the control box and drill holes through the lower section into the bar.

If you own a nutsert or rivnut tool, it can be a great way to quickly and simply add threaded mounting holes to your existing bar.



Add a silicon sealant at all holes to limit corrosion at the mount and also stop water ingress into the control box.



Mount the lower section of the control box to your bar.

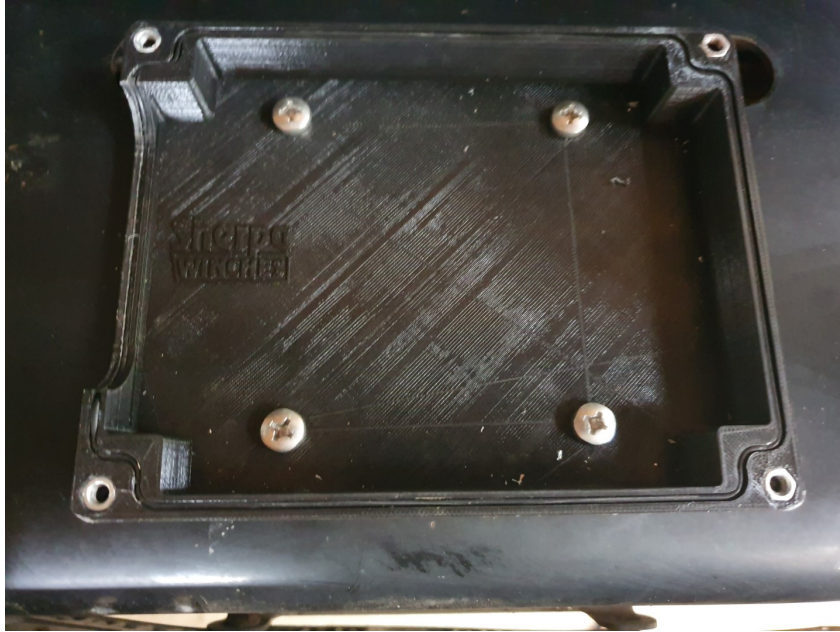

Fit upper section of the control box to the lower mount. Ensure the o-ring seal is in place during assembly.



## **Winch Lubrication**

All moving parts in the winch are lubricated with high temperature lithium grease at the time of assembly. Under normal conditions, factory lubrication will suffice for many years of service. If your winch is exposed to water crossings and extreme service, maintenance inspections and frequency should be adjusted.

Lubricate the steel cable periodically using light penetrating oil. Inspect for broken strands and replace the cable as necessary.

A small amount of lubricating oil can be applied to the engagement lever if stiffness or engagement difficulties occur.

## **Cable Replacement**

Unwind the new cable by rolling it along the ground, to prevent kinking. Remove old cable and observe the manner in which it is attached to the cable drum flange. Spool the new cable with a load of approximately 240kg. Winching the vehicle up a slight incline is a good way to achieve tension while spooling your winch, remember to monitor winch motor and cables temperatures when performing extended winching operations.

## Winch Brake

The winch brake is located inside the gearbox. The winch brake will only operate in one direction, ensure the winch is orientated and installed correctly with the cable pulling from the lower position of the drum close to the mounting bolts as per the arrow labels provided on your winch. Do not reverse the cable on your winch drum or the brake won't work.

The winch brake is a ratchet style, a bit like a sprag clutch. It applies when a force is pulled back against the winch. The harder you pull, the tighter the brake will grip. This style of brake is incredibly strong and reliable for 4x4 applications which can see water submersion and challenging environments. It also keeps the heat from the brake away from the drum and sensitive synthetic fibres.

To apply the brake, the brake shoes need to 'set' and this is achieved by winching in, stopping winching and allowing the weight of the vehicle to fall back, causing some counter rotation of the winch drum. The brake should 'set' and hold the vehicle.

If winching down a hill, the winch brake won't 'set' when the 'winch out' button is released and users should always rely on their vehicles pedal brake as the primary method of braking the vehicle. If the winch brake is not applying, it is likely due to winching out prior to activation. To 'set' the brake, 'winch in' and allow the brake to reset.

If testing the winch brake on a small slope with minimal counter force, it is possible for the drum to slowly rotate backwards and the brake not to 'set'. This can also be seen if winching on flat ground towards a fixed load, the winch may not hold tension once the winch button is released. This is due to the low stretch and resulting low opposing force. This is normal as the brake is designed to hold the weight of your vehicle on an incline when you need it.

The winch brake can be noisy as it tries to grip and some drum rotation before it grips is normal. The brake design is such that it will provide years of trouble-free service without the need to replace the brake shoes. The brake design is different to other winches and may take users time to get use to how it operates.

## Electrical Connection – Single Motor Winches

**NOTE:** It is recommended to always install a battery isolator switch in series on the +ve cable of your winch. Single motor winches can draw ~450 Amp and isolator switches should be rated for this at a minimum. Isolation should be provided on the active (Red) cable only.

Take care when tightening motor terminal nuts to always use 2 x spanners. Ensure the bottom nut does not rotate when tightening the top nut.

1. Short black cable with YELLOW sleeve (C) connecting to Terminal C (YELLOW) of the motor;
2. Short black cable with BLACK sleeve (D) connecting to Terminal D (BLACK) of the motor;
3. Short red cable with RED sleeve (B) connecting to Terminal B (RED) of the motor;
4. Earth thin cable (Terminal a) connecting to Terminal A of the motor;
5. Terminal A (BLACK long cable) connecting to Terminal A of the motor;
6. Negative “-” (BLACK long cable) connecting to the negative (“-”) terminal of battery;
7. Positive “+” (RED long cable) connecting to the positive (“+”) terminal of battery.

**WARNING!** Ensure all electrical connections are tight prior to use. Loose electrical connections may result in sparks, poor winch performance and damage to the motor and solenoid.

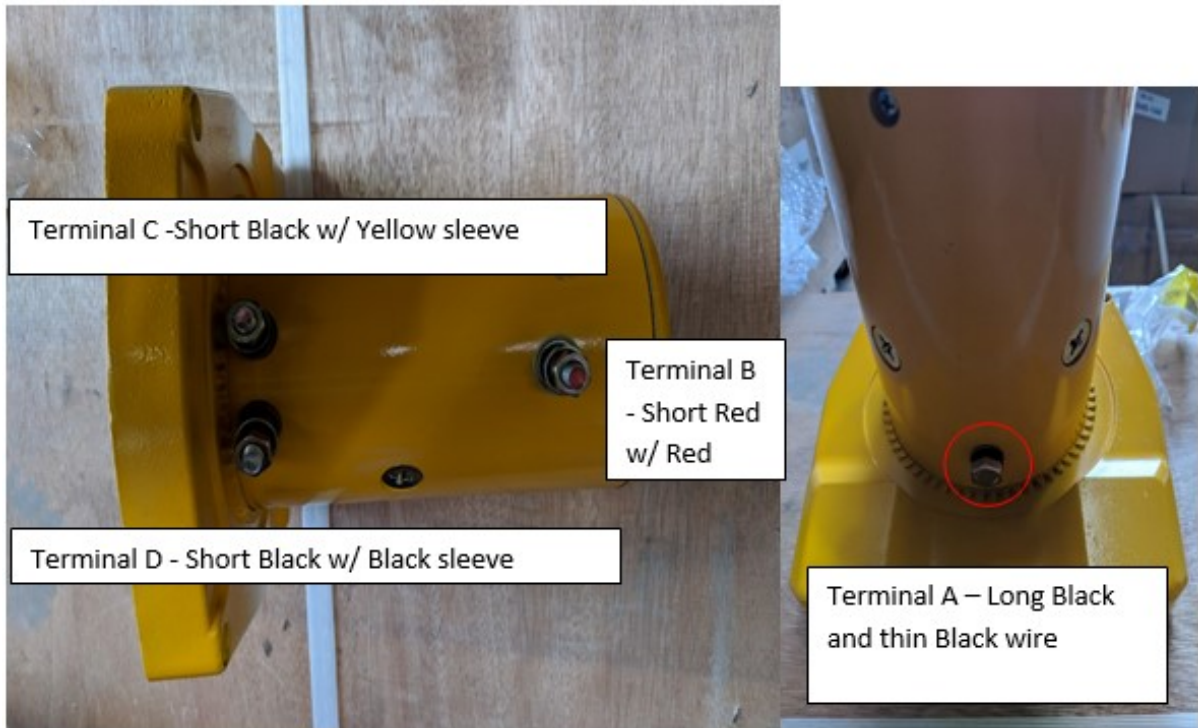
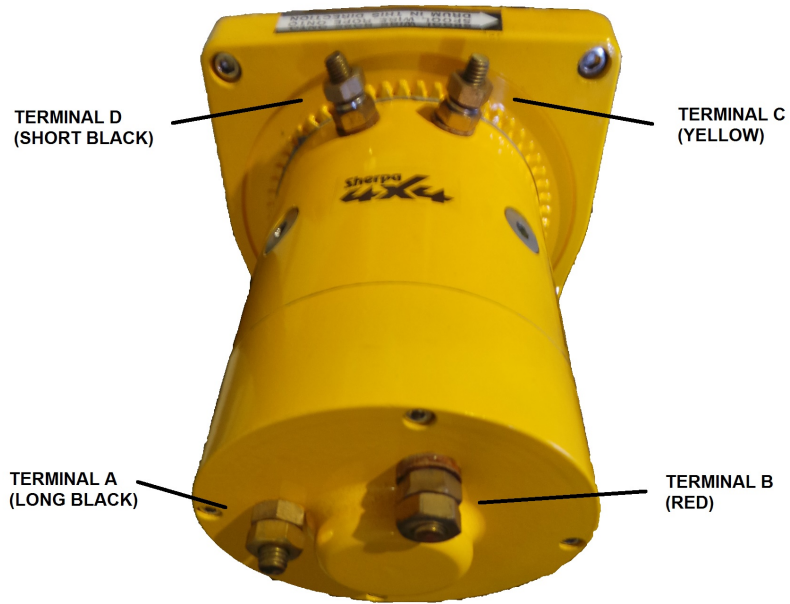

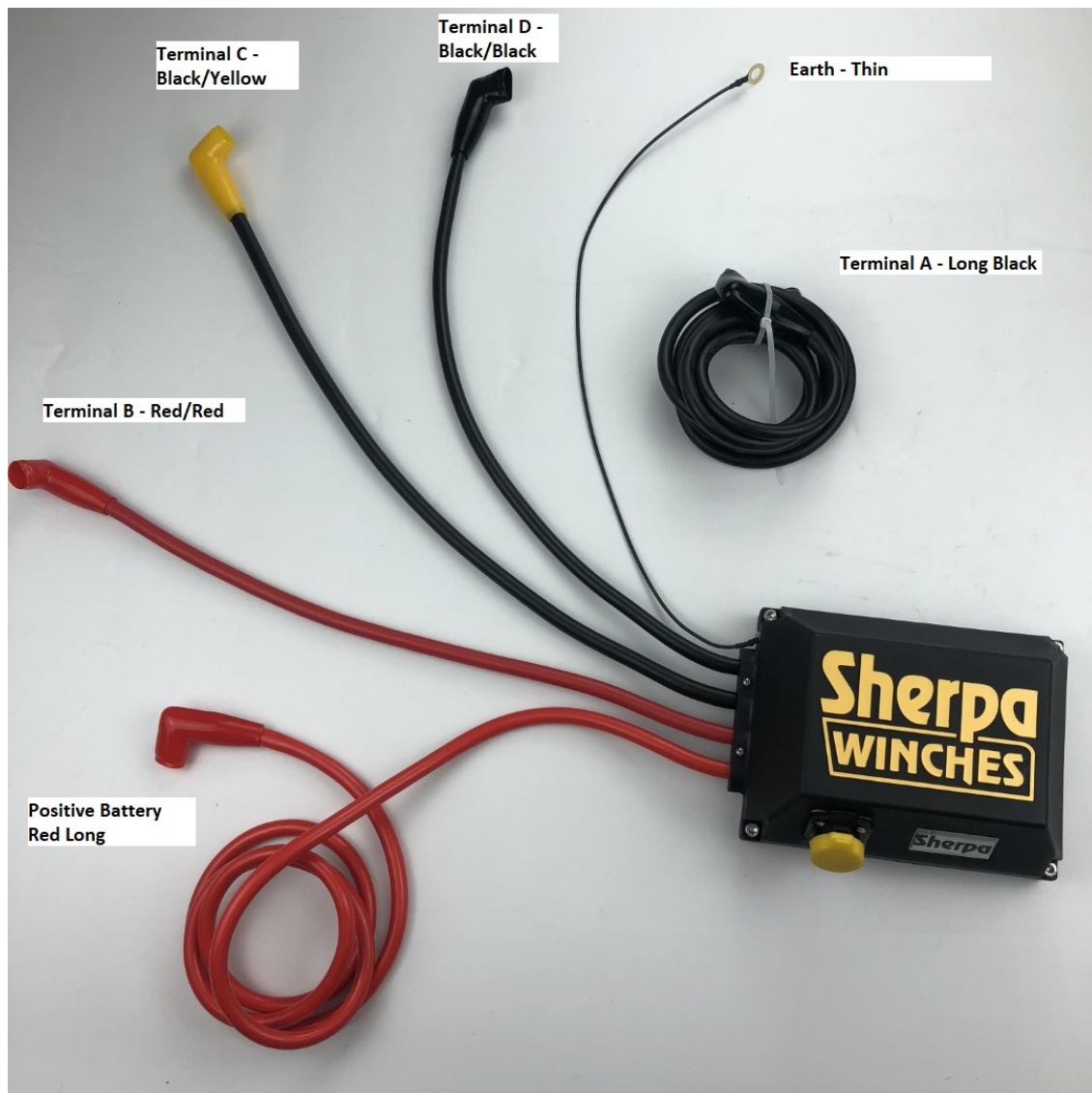

Note: Swapping cable connections at terminals C and D on the motor will reverse the winch operating direction relative to the remote controller buttons.

## Rotating the Winch Gearbox

If the gearbox handle is not in an accessible location, the gearbox can be rotated to alternate positions. Follow these instructions, a video has also been created to assist;

<https://www.youtube.com/watch?v=SEEECTKVurw>

- 1) Undo the two Allen key bolts in the cross members at the gearbox end.
- 2) Remove the gearbox and undo the six smaller black Allen key bolts on the gearbox.
- 3) On separation of the gearbox, take care to not damage the gearbox seal. Remove and store.
- 4) Rotate the gearbox as required.
- 5) Refit and begin tightening the six black Allen key bolts.
- 6) Once the gearbox is almost back together with only a 1mm separation visible, stretch the gearbox seal over the housing and allow it to drop into the 1mm gap. Tighten the gearbox bolts.
- 7) Swap the cross member bars from the drive motor end to the gearbox end of the winch.
- 8) Lay the gearbox on a flat surface with the cross member bars pointing vertically up. Fit the drum, taking care to ensure the gear adaptor fits into the gearbox.
- 9) Fit the drive rod through the centre of the drum into the centre of the gearbox and ensure it locates correctly, you will feel it drop roughly half an inch into the gearbox.
- 10) Place the drive coupling onto the other end of the drive rod. It should be recessed inside the winch drum by ~30mm.
- 11) Carefully lower the winch drive onto the coupling and ensure it locates with the cross member support bars.
- 10) Tighten the two Allen key bolts on the cross members to attach the winch drive.
- 11) Check everything is straight and fits properly. Check the Allen key bolts are done up firmly. Check the winch barrel sits properly into the drive and gearbox. There should be an even gap around the ends of the winch barrel.

### NOTE:

- For reliable winch performance, your battery must be kept in good condition.
- Be sure battery cables are not drawn taught across any surfaces, consider cable abrasion during installation.
- Corrosion on electrical connections will reduce performance and may cause an electrical short. Maintain as necessary.
- In salty environments, use a silicon sealer to protect electrical connections from corrosion.



## **Dual Motor Winches – IMPORTANT INFORMATION**

Following installation, it is highly recommended users only connect a single motor at a time and double check the winch direction matches the controller before power both motors at the same time. If motors are accidentally wired in opposing directions, damage can occur.

### **Wiring - Dual Motor Winches (Please refer to below diagram)**

**NOTE:** It is recommended to always install battery isolator switches in series with your winch. Dual motor winches can draw ~450 Amp per motor and isolator switches should be rated for this at a minimum. Dual isolators are recommended, one per battery. Under high load operations, the dual motors can pull up to 900 Amps. Due to the high amperage, Sherpa 4x4 recommends wiring to dual batteries to spread the current draw.



# Sherpa4x4

haulin' ass

| Code | Wire         |
|------|--------------|
| WS   | White Short  |
| WL   | White Long   |
| BS   | Black Short  |
| BL   | Black Long   |
| RS   | Red Short    |
| RL   | Red Long     |
| RM   | Red Medium   |
| YS   | Yellow Short |

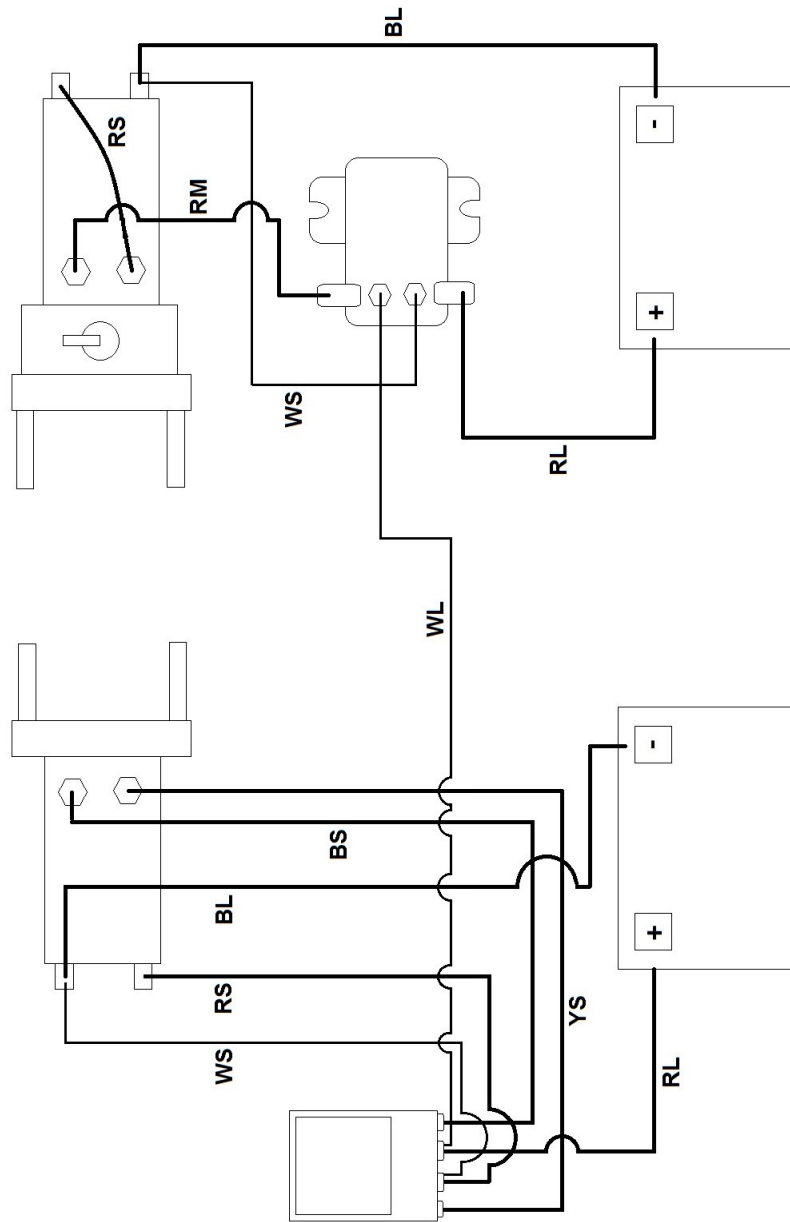

# WINCH OPERATION

## Suggestions

The best way to become acquainted with how your winch operates is to make a few test runs before you actually need to use it. Plan your test in advance. Remember you can hear your winch as well as see it operating. Get to recognise the sound of a light steady pull, a heavy pull, and sounds caused by load jerking or shifting.

## Operating

1. Ensure the vehicle is secured by applying the parking brake or chocking the wheels.
2. Pull out a desirable length of winch cable/rope and connect to an anchor point. Warning! You must leave at least five (5) wraps minimum on the drum.

### Operate the clutch as follows:

- a) To disengage the clutch, move the clutch lever to the “Disengaged” position. Cable/rope can be pulled off the drum by hand.
- b) To engage the clutch, move the clutch lever to the “Engaged” position. The winch is now ready for pulling.

**WARNING!** The clutch must be engaged fully for pulling. If not engaged correctly damage may occur.

3. Re-check all cable rigging before proceeding.
4. Plug in the winch hand held remote switch. It's recommended that the winching operation takes place from the driver's position to ensure safe operation.
5. To commence the recovery, start the vehicle engine, select neutral in transmission, maintain engine speed at idle.
6. Operate the handheld remote switch to IN or OUT to retrieve the vehicle. Regularly check the winch to ensure cable is winding onto the drum evenly.

Note: Due to the high amperage draw during winching, continuous high load winching should be avoided. Winching for 30-60 seconds (depending on load) should be followed by a 5-10 minute period of cool down. It is recommended the operator monitors the winch motor temperature to avoid overheating and damage.

### **WARNING!**

### **ALWAYS USE A WINCH DAMPER**

A safe distance must be kept during winch operation for your safety.

Never winch your vehicle in gear or in park as this will damage your vehicle's transmission.

Never wrap the cable around the anchor or hook it back onto the cable/rope.

Keep hands, clothing, hair and jewellery clear of the drum area and cable when winching.

Never allow anyone to stand near the cable/rope, or in line with the cable behind the winch while it is under load. If the cable should slip or brake, it can suddenly whip back towards the winch, causing a hazard to anyone in the area. Always stand well to the side while winching.

**DO NOT** leave the controller plugged in when the winch is not in use. Keep the battery isolation switch off when not in use.

## **MAINTENANCE**

It is highly recommended that the winch be used regularly (around once a month). Simply power the cable out 15m, freely spool 5m and then power back in. This will keep all components lubricated and in good working condition so that the winch can be relied on when needed.

Scheduled maintenance should be performed annually. If you are exposing your winch to extreme service such as regular river crossing and exceptionally muddy environments, increased maintenance frequency is recommended.

Contact the agent/distributor from whom you purchased your winch for technical assistance and repairs.

A comprehensive range of spare parts are available. For further information, please contact the agent/distributor from whom you purchased your winch.

### **WARNING!**

The safety precautions and instructions discussed in these instructions cannot cover all possible conditions and situations that may occur. It must be understood by the operator that common sense and caution are factors, which cannot be built into this product, but must be applied by the operator.

## SHERPA 4x4 WINCH SERVICE RECORD

**Sherpa4x4**  
haulin'ass



\* Please complete this form each time the winch is serviced. Service schedule is every 12 months. New forms available at [www.sherpa4x4.com.au](http://www.sherpa4x4.com.au)

**Winch Purchase Date:**

**Date of last service:**

**Date of this service:**

**Business / Company Performing Service:**

**Business / Company Address:**

**Business / Company Contact number:**

**Person performing Service:**

**Service Requirements**

**1) General Description of winch prior to service:**

**2) Remove Rope/Cable, inspect general condition, comments:**

**3) Remove electric drive from winch. Inspect motor internals for signs of moisture and dirt, clean as appropriate with circuit cleaner. Inspect motor brushes and armature for cleanliness. Report on condition, adjustments, work completed:**

**4) Loosen tie rods and remove gear box from winch. Clean and grease drum internals and centre shaft. Report on condition, adjustments, work completed:**

**NOTE:** The winch gearbox and motor generally should not require disassembly unless winch shows signs of water and mud ingress. Disassembly of gear box and motor should only be performed by confident persons.

Gearbox - Lay parts out on a clean surface in the order they are removed taking note of which surface was facing out of the gearbox.

If gearbox is disassembled, care is required not damage or accidentally discard seals or gaskets. Winch gears should be cleaned and re-greased with a high temperature gear grease.

The winch brake is located deep within the gearbox. Only replace brake shoes where extreme wear presents. Brake shoes must be orientated as per below;



Report on any work completed:

Winch Motor – Only service the winch motor with the motor removed from the winch. Re-assembly is difficult if motor is still attached to the winch.

On the end of the winch motor is a cap which can be removed to inspect the motor brushes. Check for signs of water ingress and corrosion. Clean and lubricate brush springs and check they move freely. Ensure brushes have ample material before reassembling, replace if significantly worn. For re-assembly, install armature into motor cap whilst retracting brushes. Refit armature to motor housing as the final step. All components should be reassembled with an ATV sealant at the joints to help prevent water ingress.

**5) Inspect electrical cables and report on condition including effectiveness of cable sheathing. Also report any adjustment or work completed:**

**6) Inspect control box general condition and cleanliness. Check internal wires for corrosion and damage. Report on adjustments, work completed:**



**7) Inspect hand controller and report on general condition and function:**

**8) Please list any additional notes or work performed:**

**Notes:**

Your Sherpa 4x4 winch should only be serviced by persons considered appropriate. If unsure give us a call or email.

Examples include, qualified mechanics, auto electricians, engineers, 4x4 shops.

The winch shall be removed from vehicle prior to beginning service. Genuine Sherpa4x4 parts must be used for any spare parts that may be required during the service. Contact Sherpa 4x4 as necessary to obtain parts under warranty. Photographs of faulty parts are recommended to support warranty claims.

## Sherpa 4x4 Product Warranty

The Sherpa Product Warranty only covers against faulty parts and workmanship, not general wear and tear from normal use.

### Warranty Length:

|   |            |
|---|------------|
| Sherpa 9,500Lb Steel Cable Winches        | 5 Years*   |
| Sherpa 9,500Lb Steel Cable Winches        | 5 Years*   |
| Sherpa 12,000Lb Steel Cable Winches       | 5 Years*   |
| Sherpa 12,000Lb Synthetic Rope Winches    | 5 Years*   |
| Sherpa 17,000Lb Steel Cable Winches       | 5 Years*   |
| Sherpa 17,000Lb Synthetic Rope Winches    | 5 Years*   |
| Control Boxes, Solenoids and Hand Remotes | 5 Years*   |
| Synthetic Ropes                           | 12 Months* |
| Steel Cables                              | 12 Months* |
| Fairlead and Hawse                        | 12 Months* |
| Wireless Remote Kits                      | 12 Months* |

### **\*Warranty Terms & Conditions:**

- Products must be returned to the place of purchase at the buyer's expense for warranty assessment.
- Returned products must have a completed Warranty & Returns Form accompanied by **proof of purchase**.
- Sherpa 4x4 is not liable for items lost or damaged during return freight.
- If the returned product is not covered under warranty the buyer is liable for the shipping costs to return the product to the buyer.
- Warranty and Returns are processed as fast as possible but can be up to 21 days depending on availability of parts and service technicians.
- The warranty starts from the date of purchase.
- Excessive corrosion is not covered under warranty. Corrosion cases will be at the discretion of Sherpa 4x4. Ingress of water, mud and dust will not void your winches warranty however users should be able to show proof they have made efforts to maintain their winch if they are operating in environments which result in this type of ingress.
- Synthetic rope is not covered under warranty if damage is due to neglect or general wear and tear. This will be at the discretion of Sherpa 4x4.
- Steel cables which are kinked or frayed due to improper operation are not covered under warranty.
- The Sherpa 4x4 Product Warranty does not include any defect caused by abuse, accident, improper installation or operation, lack of reasonable care, loss of parts, unauthorised modifications, tampering or attempted repair by an unauthorised person.
- If any object comes into contact with the winch causing damage, it is **NOT** covered by warranty.
- This warranty does not cover general wear and tear incurred by normal use of the product.
- Modifications to the winch, control box or wiring may void this warranty and will be at the discretion of Sherpa 4x4.

## Additional Conditions For Sherpa 4x4 Winches

- Your Sherpa 4x4 Winch should be serviced every 12 Months by a suitably qualified professional. This is especially important if you operate your winch under water or in extremely muddy environments. Whilst your winch is well sealed to water and mud ingress, it is not recommended to operate in these environments without a maintenance regime to match the conditions and serviced asked of your winch.
- A copy of service receipts may be requested for a warranty claim.
- The winch should be used with a minimum 650 Cold Cranking Amps battery
- The winch **MUST** have at least 1 complete layer of cable/rope on the drum at all times, the cable has a red mark which identifies the minimum that must remain on the drum.
- The winch **MUST** be mounted to a suitable winch compatible bull bar or winch cradle only.
- The winch **MUST** be used as per the instruction manual.
- **Do Not** hook the winch cable / rope onto itself
- **Do Not** exceed the pulling limits of the winch
- **Do Not** shock load the winch
- **Do Not** overwork the winch. The drives have a duty cycle and should not be overheated.