



USER MANUAL

objecto

Safety Information

- Before use, be sure to carefully read this manual for safety issues and to ensure that you use this product correctly.



In order to avoid any electrical shock, short-circuit, burns, or possibly cause a fire:

- Do not disassemble. This product may only be disassembled by qualified repair technicians. To request repair, see Warranty Page at the back of this manual.
- Do not use if the power cord or plug is damaged, or if the plug is not fully inserted into the outlet.
- Do not scratch, damage, modify, forcibly bend, pull, twist, bind/clamp, or place heavy objects on the power cord.
- Do not insert metal objects, such as pins, wires, or other foreign materials into any gaps of the product.
- Do not allow children to use this product by themselves, and keep product and power cords out of the reach of small children.
- Use only with the designated power supply 110 – 120 V.



When cleaning the product, be sure to unplug the power cord from the outlet.

Do not use in area with high humidity (85% or higher).

Do not use in area where the mist directly contacts furniture, bedding, walls, curtains, ceiling, or other objects.

Do not place on slanted surfaces, high locations such as bookshelves, or on unstable surfaces.

English

Do not place the humidifier directly onto a carpet or other object with soft fibers or a thick pile. These could block the vent hole from performing properly and can cause the unit to malfunction or leak.

Do not block the mist outlet.

Fill the reservoir tank using only clean cool tap water.

Do not use hot water. Use of hot water that is 104°F or higher can cause the product to deform and malfunction.

Never put aroma oil or other fragrances into the water reservoir tank as this can damage the humidifier.

Do not wipe product with turpentine/benzene, thinner or other chemicals, since this can ruin the sheen.

When unplugging the power cord, always unplug by grasping the power plug, not by pulling on the power cord. If the supply cord is damaged, it must be replaced by the manufacturer, or its service agent.

Spill out the water when not using the humidifier or when moving the appliance.

Replace the water in the reservoir tank with fresh water every day. Regularly maintaining the inside will ensure that the product is always clean and ready for use.

Be sure that the water passage cover is always reattached before use. Use without attaching the cover could result in water spillage. Do not remove the cover unless cleaning the hybrid humidifier

Do not place cell phones, computers, or other electronic devices near the humidifier. The area around the humidifier can become very humid while the humidifier is operating and these items are sensitive to humidity. Product should be placed at least 6 feet away from these objects.

Take care that the product does not freeze. If the product is placed in a area subject to freezing temperatures, spill out all the water inside.

Parts and Their Functions

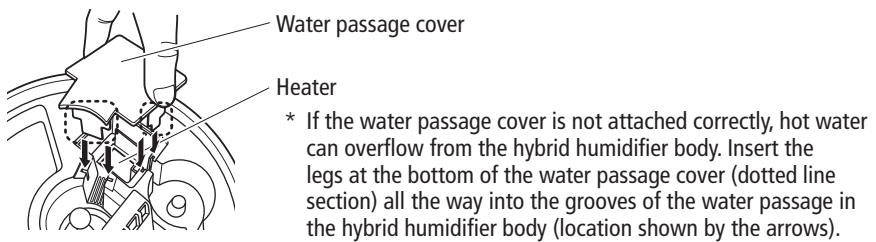
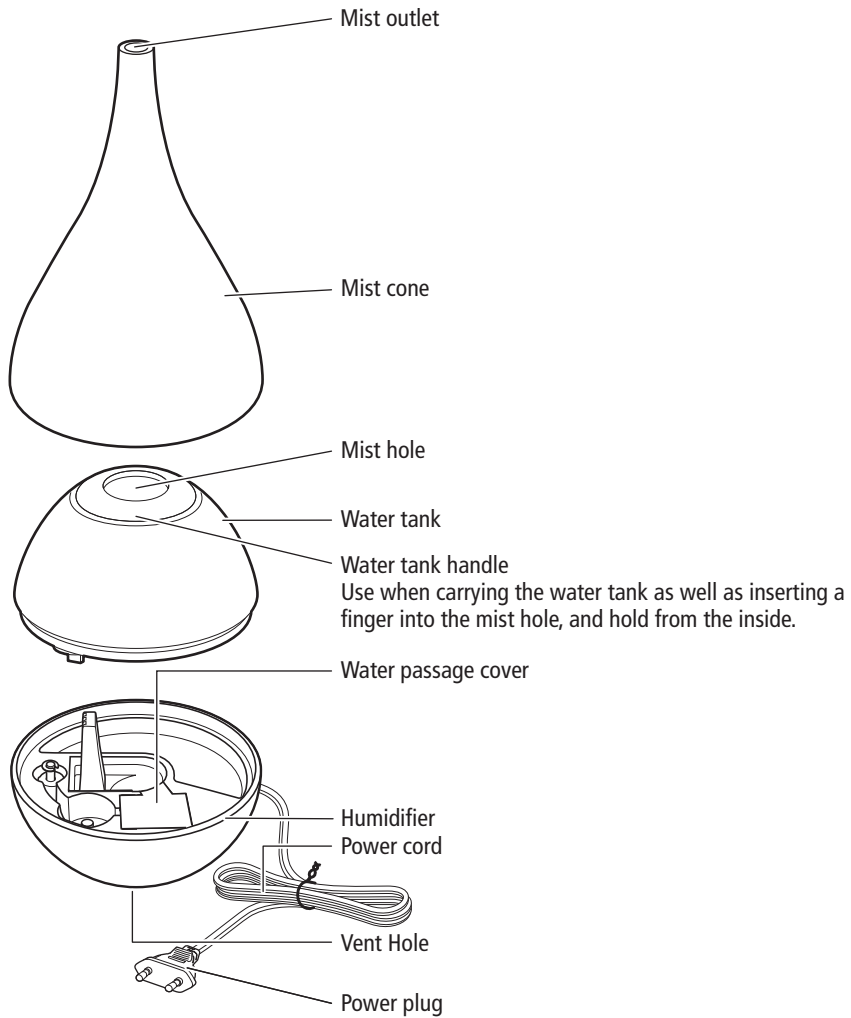

Inside body

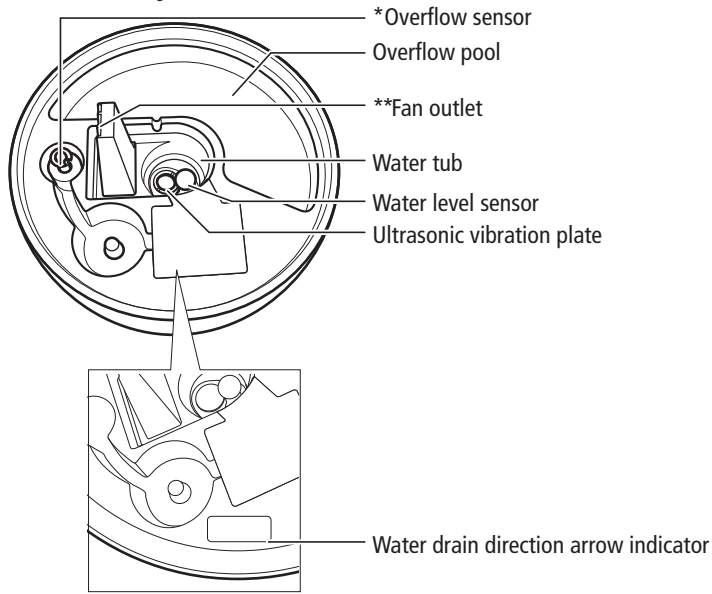

Bottom of Water Tank

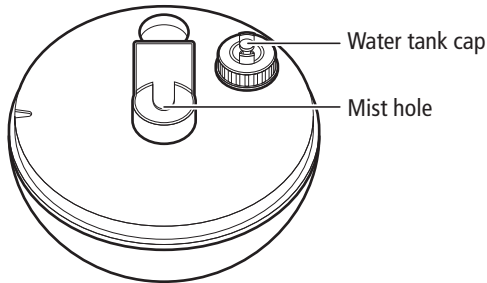

Accessories

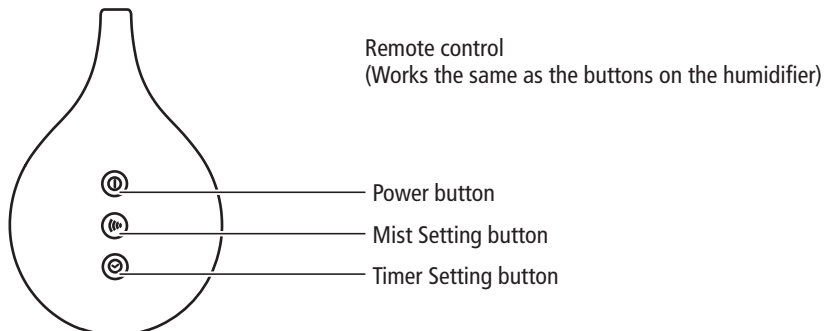



Aroma base



Replacement felt × 2



Lithium button battery for the remote control

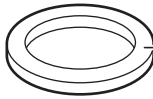

Remote control stand

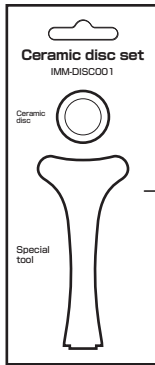

Replacement ceramic disc set

CAUTION

*** Overflow sensor**

An overflow occurs when the water level is excessively high. The overflow sensor will be activated and the heater operation will stop. This is to prevent water from overflowing into the electrical part of the unit. If water has collected in the overflow pool, drain it. When the water level in the water passage returns to normal, restart operation.

**** Fan outlet**

Take care not to get water into the fan outlet or overflow drain when filling with water, draining out water or cleaning.

Operating Instructions for Hybrid Humidifier

1. Place the hybrid humidifier on the aroma base.

Insert the brackets on the aroma base all the way into the corresponding holes on the bottom of the hybrid humidifier.

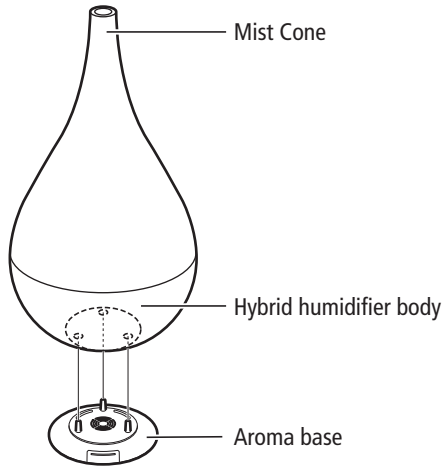

2. Place the hybrid humidifier with the connected aroma base on a flat sturdy surface.
3. Turn the mist cone at the top of the hybrid humidifier to remove it.
4. Remove the water reservoir tank from the hybrid humidifier, unscrew the water cap and fill with room temperature, clean tap water.
5. Firmly tighten the water tank cap, wipe up any spilled water, and turn it over to check that no water is leaking.

Bottom of Water Tank

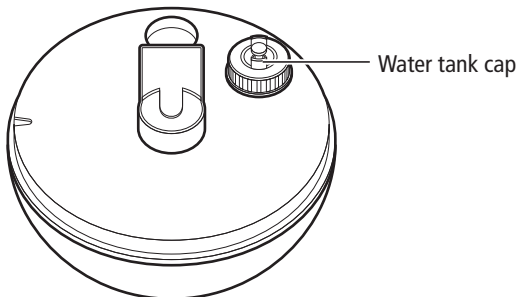

CAUTION

Be careful when removing the water tank since there might be some water remaining there and can possibly spill out. Prepare towels beforehand so that the hybrid humidifier and the floor do not get wet.

6. Place the water tank into the hybrid humidifier so that it fits securely. Replace the mist cone cover onto the hybrid humidifier.
7. Plug the power cord plug firmly into the outlet.

WARNING

If you are going outside or will be away from home for an extended period of time, unplug the power cord from the outlet.

When going to bed during the winter, if your heat is turned off and the room temperature drops below 59°F, continued misting operation can result in condensation. This can cause the hybrid humidifier body and the floor to get wet.

If using in environments where the room temperature is expected to drop below 59°F or the humidity is expected to be above 60% when going to bed, either set misting operation to L (Low) or SL (Min), or stop the misting operation altogether.

Power Button Operations:

1. When the Power button is pressed, the Power/Water indicator (P/E) light is GREEN, the misting operation starts after about two minutes. The delay is due to the water temperature heating up to at least 140°F for sterilization before starting the misting operation.

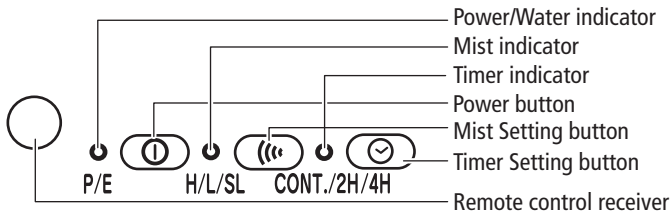

2. To stop - Press the Power button again. After misting operation is stopped, the fan will run for about one minute before the hybrid humidifier comes to a complete stop.

Setting the Mist and Timer Operations:

1. Press the Mist Setting button. Each time this button is pressed, the setting cycles and color of light change as per chart below:

H (High) → L (Low) → SL (Min.)

Mist setting	Indicator color
H (High)	BLUE
L (Low)	YELLOW
SL (Min.)	Flashes YELLOW

2. Press the Timer Setting button. Each time the button is pressed, the setting

English

cycles change. 2 Hours (off after 2 hrs.) → 4 Hours (off after 4 hrs.) → Continuous operation. The setting cycles and color of light change as per chart below:

Continuous operation → 2H (off after 2 hrs.) → 4H (off after 4 hrs.)

Timer setting	Indicator color
2 H (off after 2 hrs.)	YELLOW
4 H (off after 4 hrs.)	Flashes YELLOW
Continuous operation	OFF (no light)

Keep the humidifier an appropriate distance from walls and surrounding objects

Pay attention to the following points when using the humidifier.

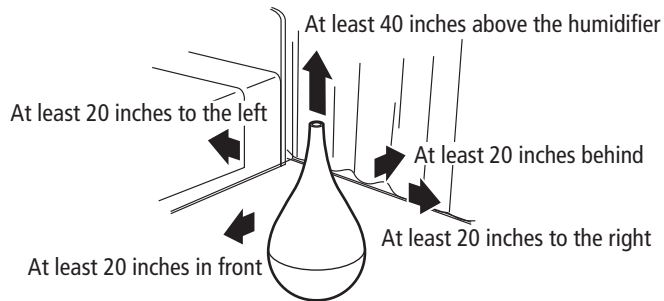

The Power/Water indicator (P/E)

When the Power/Water indicator (P/E) is lit RED, this means that the water level in the water tank is low and the alarm will beep five times.

- 1 After draining any water remaining in the water passage, refill the water tank with new clean tap water.
- 2 When water reaches the hybrid humidifier from the water tank, the Power/Water indicator (P/E) RED light will automatically turn off.
- 3 Press the Power button to start operation.

Using the Aroma Fragrance Feature

1. Pull out the felt case from the aroma base stand holding the hybrid humidifier.

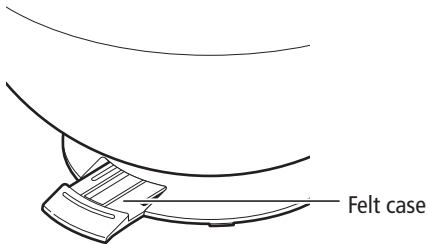

* Insert the felt circle so that it fits under the clips in the felt case.

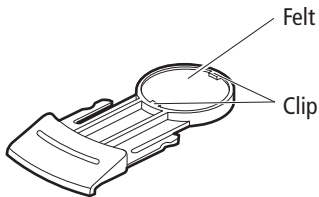

2. Trickle 2-4 drops of aroma oil or essential oil onto the felt circle located in the case. (These oils are available commercially). Take care that oil does not spill outside the case – if some oil spills on the base simply wipe it up before proceeding. Make sure that the felt circle is fully inserted into the indented area of the case. Then insert the case all the way inside the hybrid humidifier.

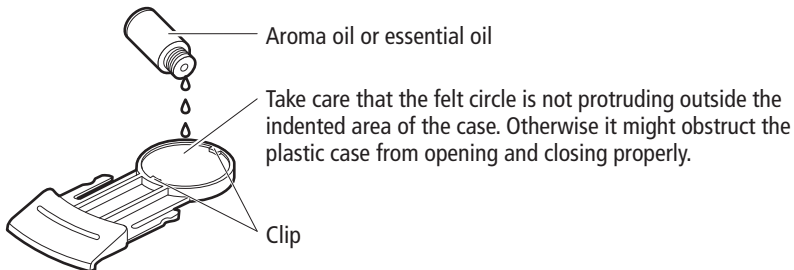

CAUTION

- Do not use any other material in the aroma base only the special felt specifically designed for this product – otherwise you can damage the aroma base or cause it to malfunction.

3. To start operation, follow the instructions on page 8.

If aroma oil is not added, your hybrid humidifier functions as a regular humidifier.

Replace the felt circle whenever it becomes dirty, or when using a different type of aroma oil or essential oil.

Please note: In addition to the felt already included with the aroma base at purchase, two additional pieces are also included. The felt cannot be washed or re-used.

English

- * Wash the case with a soft cleanser, and carefully wipe up any moisture before inserting plastic case it into the aroma base.
- * The Replacement Felt AF-04 is sold separately.

Handling of aroma oils and essential oils

- * Do not expose the oils to an open flame.
- * Store in a location that is out of the reach of children.
- * If oils are spilled on clothes or other objects, rinse with a lot of water and allow to air dry. Do not use a blow dryer as this could cause a fire.
- * If any oil gets on your hands, wash them immediately.
- * For further details about the handling of aroma oils and essential oils, refer to the manufacturer's manual.

Cleaning

- Press the Stop Button and unplug the power cord. Allow the unit to cool (takes about 10 minutes).
- Do not touch any of the metal parts inside the hybrid humidifier – which can become quite HOT.

Fully drain the water left inside the hybrid humidifier in the direction of the arrow shown on the humidifier body and fully dry.

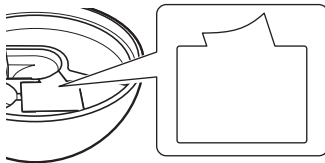

Attach the water passage cover to avoid leakage.

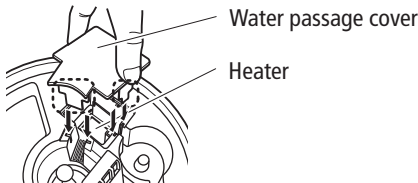

- * Clean the air inlet filter at the bottom of the hybrid humidifier.
Use a vacuum cleaner or soft brush to clean the dust off the filter.

Fill the water tank with cool clean tap water, fasten the cap, thoroughly shake the water tank, and then drain. (Repeat this two or three times.)

Clean the outside with a soft cloth – do not use any chemicals that will discolor or scratch the glossy finish.

Remote Control

Inserting a Battery

Follow the steps below to insert a new battery (lithium battery).

1. Take out the battery holder.
 - * Pull it out with your finger.
2. Insert the battery with the +/- oriented correctly.
 - * Insert with the plus (+) side up.
3. Slide the battery holder back in - facing in the right direction.
 - * Push it in until you hear it catch.

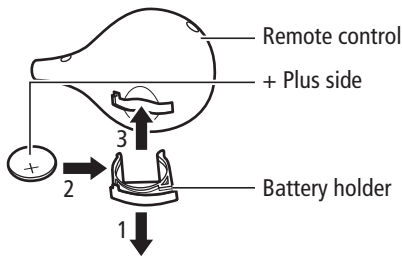

CAUTION

- To prolong battery life, remove the battery when the humidifier won't be used for a long time.
- Insert the battery correctly to prevent damage and/or leaking.
- Never recharge, short, disassemble, heat or throw a battery into a fire.
- If a leak should occur, wipe off the terminals thoroughly and insert a fresh battery.

Using the Remote Control

When using the remote control, point it at the receiver on the humidifier.

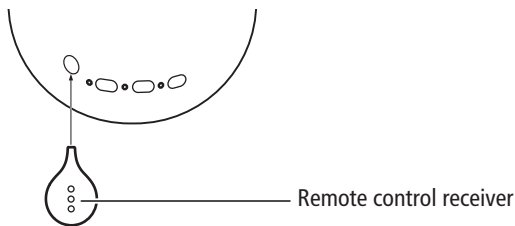

Operating range

- Ten Ft. in a straight line from the front of the humidifier
- Right/left 30° from the front of the humidifier
- The remote control may not work correctly if there is an obstruction between it and the humidifier

Handling the Remote Control

When not in use, put the remote control on its stand.

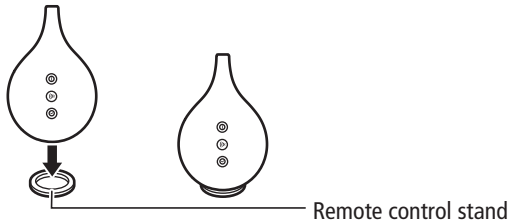

- * The remote control is not designed to stand up straight.

CAUTION

Take care not to drop the remote control.

If dropped, the remote control may be damaged, and an injury could result.

Replacing Ceramic Disc (part sold separately)

The ceramic disc should last for about 3,000 hours. If the ceramic disc is used longer than that, the amount of mist generated will diminish or stop completely.

- a) Turn off the power, unplug the power cord, drain the water and dry completely.
- b) Use the special tool to turn the ring holder counter-clockwise, and then remove the ring holder and ceramic disc from the hybrid humidifier body.
- c) To attach the replacement part, perform the removal procedure in reverse to attach to the ultrasound vibration plate, and use the special tool to tighten the ring holder.

Note: 1. The replacement ceramic disc is protected by a rubber ring to prevent breakage. When attaching, remove the rubber ring while being careful not to damage the ceramic disc.

2. The ceramic disc has a front side and back side. When attaching it, do so with the front side visible.

See illustration on next page.

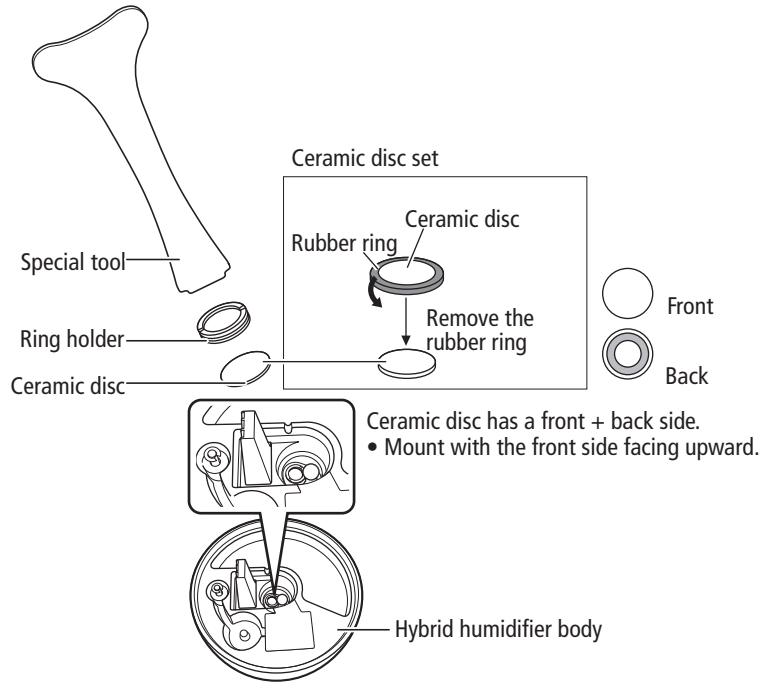

Storage

Wipe up any moisture inside the hybrid humidifier body, allow it to dry completely, pack it back in the original box along with the User's Manual, and store it in dry cool place.

Check the following before Requesting Repair or Service

Problem	Primary cause	Solution
The power does not turn on.	<ul style="list-style-type: none"> Is the power cord plugged into the outlet? 	Plug the power cord into the outlet.
No mist is generated, or the amount of mist is minimal.	<ul style="list-style-type: none"> Is the Power/Water level low (P/E) light RED? Is it time to replace the ceramic disc (after 3,000 hours of operation)? 	<ul style="list-style-type: none"> Fill with water. Press the Power button - the hybrid humidifier will not produce mist for about two minutes – allowing the water temperature to heat up to 140°F for sterilization. Replace the ceramic disc (See page 13).
The Power/Water indicator (P/E) light RED even though water was filled.	<ul style="list-style-type: none"> Is the water tank inserted securely in the hybrid humidifier? 	Take out and re-insert the water tank securely into the humidifier.
A smell is emitted.	<ul style="list-style-type: none"> Are you using water other than clean tap water? 	Drain the water left in the water tank, clean product by following the procedure in the "Cleaning" section.
The mist nearly stops once every minute.	<ul style="list-style-type: none"> This is not a malfunction. To prevent water from collecting at the mist outlet, the fan motor stops about once every minute, and the fan stops for about two seconds. 	This is a normal operation function.
Cannot operate with the remote control	<ul style="list-style-type: none"> Is the battery worn out? Is the battery in upside down? 	<ul style="list-style-type: none"> Replace with a fresh battery The + side goes up when inserting the battery (See page 12)

Specifications

Product name	H4 Hybrid Humidifier
Model	HM27-9
Power supply	110 –120 V, 50/60 Hz
Power consumption	48 W
Humidification	Per hour H (High): Approx. 6 oz, L (Low): Approx. 3 oz, SL (Min.): Approx. 1.3 oz
Continuous humidifying time	Approx. 11 hrs (in High mode (H)) Approx. 20 hrs (in Medium mode (M))
Tank capacity	Approx. 0.49 gal
Power cord length	Approx. 70 inches
Size	Diameter 8 inches × Height 14.4 inches
Weight	Approx. 2.4 lbs (body only)
Accessories	User's Manual × 1, Remote control × 1, Remote control battery × 1, Aroma base (1 felt sheet provided in base) , Replacement felt × 2, Ceramic disc set × 1, Remote control stand × 1

* Due to a continuous process of product improvement, the specifications and other information are subject to change without notice.



LIMITED WARRANTY POLICY

Thank you for selecting our Products.

Please carefully read the User's Manual furnished with this product. We believe that you will be very satisfied with your purchase. We will provide the following LIMITED WARRANTY to you as the original purchaser.

Should service be necessary for any reason due to manufacturing defect or malfunction during the 90 days period, OBJECTO will provide carry-in repair service at our FACTORY SERVICE CENTER at no charge, and for the duration of the extended 9 months parts warranty period will replace the defective part only, not including labor, provided the defect or malfunction is verified along with the date of purchase. In the event service is necessary, you may return the unit to our FACTORY SERVICE CENTER listed below.

- a) Pack the unit in a well-padded heavy corrugated box. Be certain that the unit is well protected.
- b) Enclose your check or money order payable to H.S.I REPAIR CORP, in the amount of \$40.00.
- c) Enclose copy of proof of purchase.
- d) Ship the unit prepaid via UPS or parcel post insured.

NOTE: This warranty does not cover.

- a) OBJECTO products which have been damaged by negligence, misuse or accident or which have been modified or repaired by anyone other than our FACTORY SERVICE CENTER.
- b) Damage to OBJECTO equipment that has been improperly connected to the equipment of other manufacturers
- c) Costs incurred in the shipping of OBJECTO products to our FACTORY SERVICE CENTER.

This warranty is valid only to the original purchaser and does not extend to owners of the product subsequent to the original purchaser. Any applicable implied warranties, including the warranty of merchantability, are limited in duration to a period of 90 days from the date of original purchase at retail and no warranties, whether expressed or implied, shall apply to this product thereafter. Under no circumstances shall OBJECTO be liable for any loss or damage, direct or consequential, arising out of the use of, or inability to use this product. (Some states do not allow limitation or implied warranties or exclusion of consequential damage, therefore these restrictions may not apply to you.)

This warranty gives you specific legal rights and you may also have other rights which may vary from state to state.

- a) The Limited Warranty Registry Card must be completely filled out and mailed immediately, in order to validate the Limited Warranty.
- b) You must include copy of your purchase slip when you are returning the unit.

Register your new product online at WWW.OBJECTO.com

SERVICE INFORMATION:

OBJECTO

935 BROADWAY, 6TH FL.

NEW YORK, NY 10010

TEL: (844) OBJECTO (844-625-3286)

FAX: 800-433-9099

WEBSITE ADDRESS: WWW.OBJECTO.COM

English

6C14A