

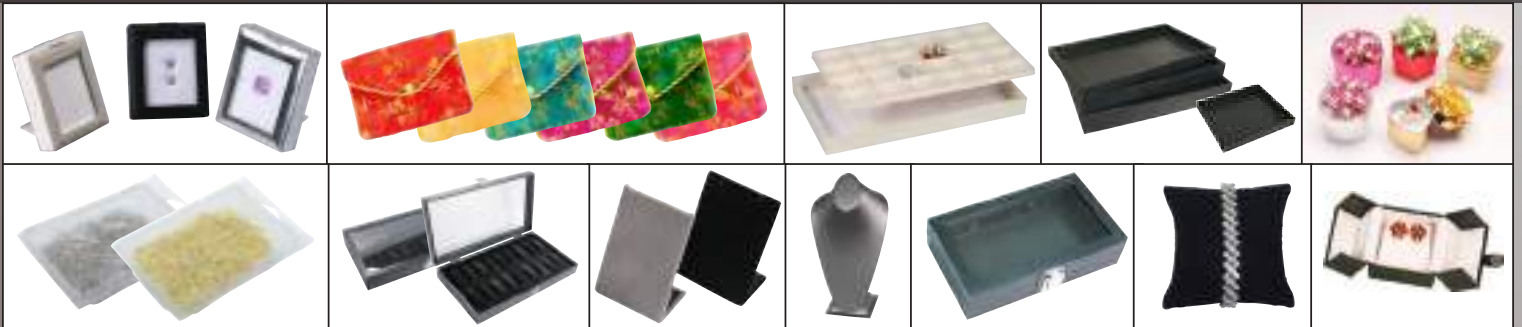

2016-2018

Display and Packaging

A&A JEWELRY SUPPLY



Address: 319 W. 6th St, Los Angeles, CA 90014

Tel: (213) 627-8004 ■ **Fax:** (213) 627-1653

For Orders

Tel: (800) 433-5544 ■ **Fax:** (888) 888-8770

Email: orders@aajewelry.com

Web: www.aajewelry.com

Table of Contents



BOX 2



Bag & Pouch 34



Showcase Set 50



Showcase Tray 86



Ring Display 92



Figurine 104



Necklace Display 107



Slatwall 139



Bracelet Display 142



T-Bar 148



Earring Display 154



Mirror 171



Acrylic 174



Gem Display 182



Presentation Folder 189



Salesman's Organizer 195



Standard Tray 207



Tray Insert 210



Body Jewelry 217



Watch Display 219



Tool 227



Store Supplies 236



Vape Display 247

Shop Thousands of Choices Now

Self-Wrapped Paper Boxes



F. PQ7N-CP

C. PQ7E-CP

D. PQ2W-CP

Box Collection

2

E. PQ5B-CP

A. PQ3R-CP

B. PQ3E-CP

Shimmer
Copper
-CP

* Ready-to-go design including a pre-wrapped sleeve and tape to allow instant sealing

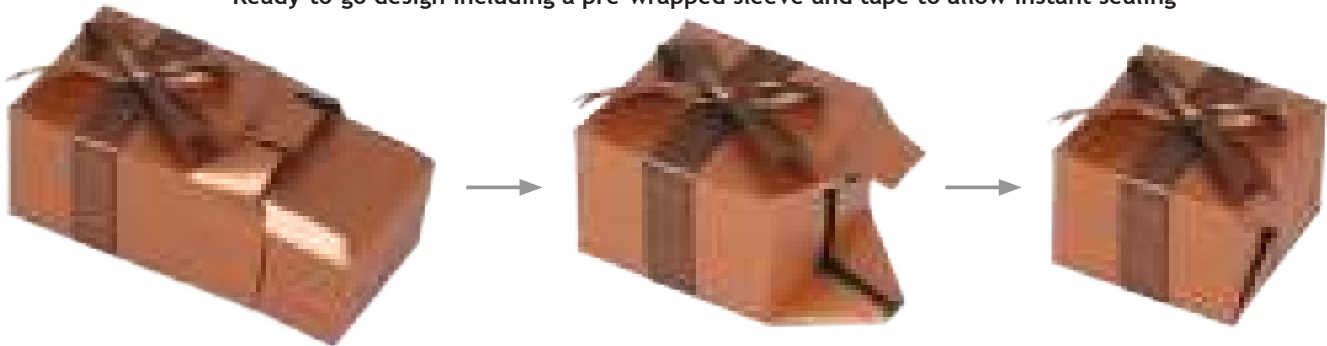

Item	Description	Size: W x D x H	(mm)
A.	PQ3R-CP	Ring	2 1/8" x 2 1/8" x 1 1/2" (53 x 53 x 37)
B.	PQ3E-CP	Earring	2 1/8" x 2 1/8" x 1 1/2" (53 x 53 x 37)
C.	PQ7E-CP	Earring/Pendant	3 3/8" x 3 3/8" x 1 1/4" (86 x 86 x 32)
D.	PQ2W-CP	Watch (pillow)	4" x 4" x 3" (102 x 102 x 76)
E.	PQ5B-CP	Bracelet/Watch	8" x 1 3/4" x 1 1/4" (203 x 45 x 32)
F.	PQ7N-CP	Necklace	6 1/8" x 5 1/8" x 1 1/4" (156 x 130 x 32)

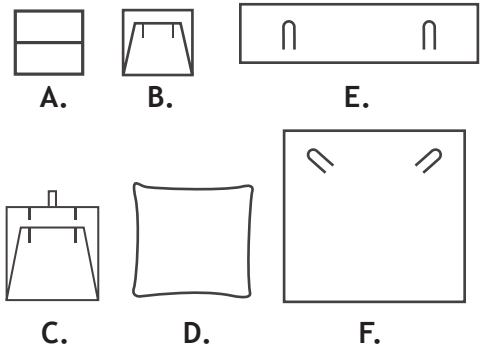

Deluxe Burlap Magnetic Boxes

* Burlap material and accented with a natural wood grain design paper. Come with white velvet insert.



PJ7V-N3
Necklace
4 5/8" x 7 1/2" x 1 3/8"H
(117 x 190 x 35mm)

PJ5B-N3
Bracelet/Watch
8 5/8" x 2 3/8" x 1 1/4"H
(220 x 60 x 33mm)



PJ2W-N3
Watch (Pillow)
4" x 4 1/8" x 3"H
(102 x 104 x 76mm)

PJ4E-N3
Earring/Pendant
2 3/4" x 3 1/4" x 1 3/8"H
(70 x 82 x 36mm)

PJ3R-N3
Ring
2 1/8" x 2 3/8" x 1 3/4"H
(53 x 61 x 43mm)

PJ6C-N3
Combination
3 1/2" x 3 5/8" x 1 5/8"H
(90 x 92 x 42mm)

Deluxe Blue Magnetic Boxes



PF2W-BL
Watch (Pillow)
4" x 4 1/8" x 3"H
(102 x 104 x 76mm)

PF6C-BL
Combination
3 1/2" x 3 5/8" x 1 5/8"H
(90 x 92 x 42mm)

PF4E-BL
Earring/Pendant
2 3/4" x 3 1/4" x 1 3/8"H
(70 x 82 x 36mm)



PF7V-BL
Necklace
4 5/8" x 7 1/2" x 1 3/8"H
(117 x 190 x 35mm)

PF3R-BL
Ring
2 1/8" x 2 3/8" x 1 3/4"H
(53 x 61 x 43mm)



* Deluxe black paper box accented with cobalt blue trim. Come with black velvet insert.

PF5B-BL
Bracelet/Watch
8 5/8" x 2 3/8" x 1 1/4"H
(220 x 60 x 33mm)

Elegant Bowtie Boxes

* These elegant steel grey boxes feature satin ribbon and a superior plush insert, displaying a modern yet sophisticated statement.



* Steel grey boxes with satin ribbon and a superior plush insert.

Item	Description	Size: W x D x H	(mm)
A. PLE3-P22	Earring	2 1/2" x 2 1/4" x 1 1/2"	(63 x 57 x 38)
B. PLR3-P22	Ring	2 1/2" x 2 1/4" x 1 1/2"	(63 x 57 x 38)
C. PLP9-P22	Pendant/Earring	3 5/8" x 3 5/8" x 1 7/8"	(92 x 92 x 47)
D. PLW8-P22	Watch (Pillow)	3 5/8" x 3 5/8" x 2 3/4"	(92 x 92 x 70)
E. PLB5-P22	Bracelet/Watch	8 5/8" x 2 3/8" x 1 3/8"	(220 x 60 x 35)
F. PLN10-P22	Necklace	6 3/8" x 6 1/8" x 1 7/8"	(162 x 156 x 47)

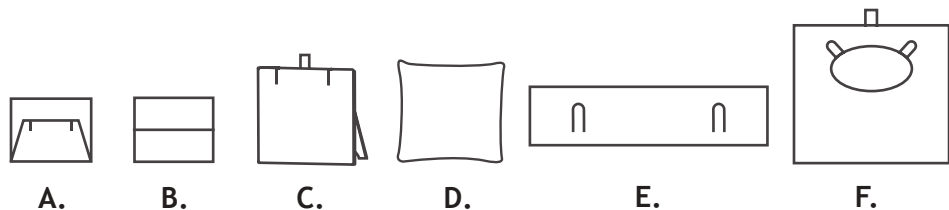

■ Frame Style Jewelry Boxes



NEW



Two piece matching color packer included.

KB-12N2-BK
10 5/8" x 8 3/4" x 1 5/8"H
(272 x 222 x 41mm)

KB-12N1-BK
7 1/8" x 7 1/4" x 1 1/4"H
(180 x 184 x 32mm)

KB-12B5-BK
11 5/8" x 3 5/8" x 1 1/4"H
(295 x 92 x 32mm)

KB-12P9-BK
5 1/8" x 5" x 1 1/4"H
(130 x 127 x 32mm)

KB-12E4-BK
4" x 4" x 1 1/4"H
(102 x 102 x 32mm)

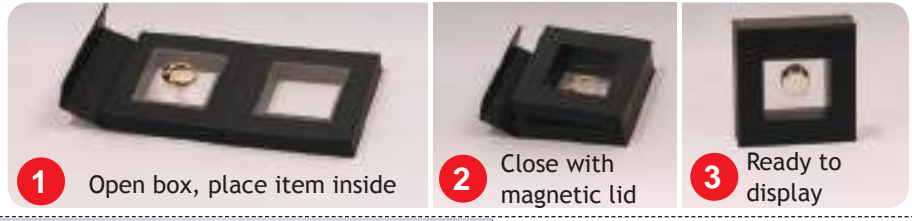

1 Open box, place item inside

2 Close with magnetic lid

3 Ready to display

Box Collection

5

■ Lighted Ring Box

* Made of high quality black faux leather with black suede interior. Includes a 3 volt coin battery for light.

NEW



KC-11R5-BK
Lighted Ring Box
3" x 3" x 2 3/8"H
(78 x 78 x 62mm)

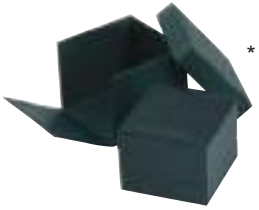

* Each box comes with a two piece packer that opens in front for easy box access.

■ Black Faux Leather Boxes

* Made of luxurious black faux leather exterior with black velvet insert. Available in four styles.



Includes two piece packer that opens in front for easy box access.



NEW

KC-31R5-BK
Large Ring Box
3" x 3" x 2 3/8"H
(78 x 78 x 62mm)

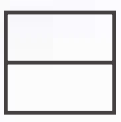

KC-31E6-BK
Earring Box
3" x 3" x 2 3/8"H
(78 x 78 x 62mm)



KC-31P9-BK
Pendant Box
3" x 3" x 2 3/8"H
(78 x 78 x 62mm)



KC-31E7-BK
Earring / Pendant Box
3" x 3" x 2 3/8"H
(78 x 78 x 62mm)



Plush Cream Faux Leather Boxes

* This plush faux leather comes in a soft cream color that is easy on the eye and soft to the touch, with the look and feel of exquisitely supple and smooth leather.



I. JLN7-L32

G. JLB5-L32

H. JLW8-L32

D. JLP6-L32 E. JLE5-L32

Box Collection

F. JLW10-L32

B. JLE3-L32

C. JLR5-L32

A. JLR3-L32

6

2-piece packer included.



Plush Cream Faux Leather -L32

	Plush Cream Faux Leather	Description	Size: W x D x H	(mm)
A.	JLR3-L32	Ring	2 1/4" x 2 1/4" x 1 5/8"	(57 x 57 x 41)
B.	JLE3-L32	Earring	2 1/4" x 2 1/4" x 1 5/8"	(57 x 57 x 41)
C.	JLR5-L32	Double Ring	3" x 2 1/4" x 1 3/4"	(76 x 57 x 44)
D.	JLP6-L32	Pendant	2 3/4" x 3 1/8" x 1 3/8"	(70 x 79 x 35)
E.	JLE5-L32	Large Earring	2 3/4" x 3 1/8" x 1 3/8"	(70 x 79 x 35)
F.	JLW10-L32	Bangle/Watch	3 3/4" x 3 3/4" x 1 7/8"	(95 x 95 x 47)
G.	JLB5-L32	Bracelet	9 1/2" x 2 1/8" x 1 1/4"	(241 x 54 x 32)
H.	JLW8-L32	Watch (pillow)	4 3/8" x 4 3/8" x 3 1/4"	(111 x 111 x 82)
I.	JLN7-L32	Necklace	7 1/4" x 7 1/2" x 1 7/8"	(184 x 191 x 47)

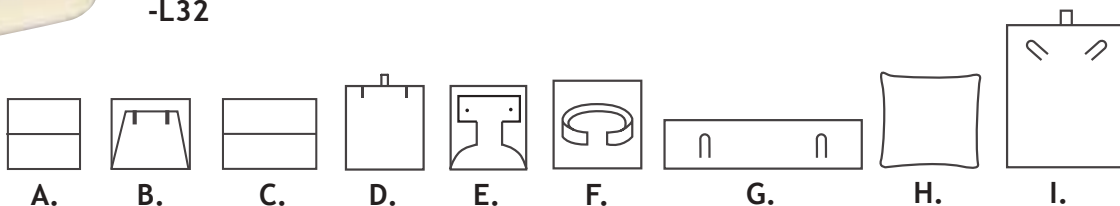

Round Corner Style Faux Leather Boxes

I. RCN10 -Color



* The soft faux leather boxes are enhanced by the round contoured edges.
* 2-piece packer included.

E. RCE9 -Color



H. RCN7 -Color



G. RCB5 -Color

B. RCR3 -Color



C. RCR5 -Color



A. RCE3 -Color



D. RCE4 -Color



F. RCW9 -Color

	White Faux Leather	Black Faux Leather	Description	Size: W x D x H (mm)
A.	RCE3	RCE3 -BK	Earring	2" x 2 3/8" x 1 3/4" (50 x 60 x 45)
B.	RCR3	RCR3 -BK	Ring	2" x 2 3/8" x 1 3/4" (50 x 60 x 45)
C.	RCR5	RCR5 -BK	Double Ring	3 1/8" x 2 3/8" x 1 1/2" (80 x 60 x 38)
D.	RCE4	RCE4 -BK	Pendant/Earring	2 3/4" x 2 3/4" x 1 1/8" (70 x 70 x 28)
E.	RCE9	RCE9 -BK	Pendant/Earring	2 3/4" x 4" x 1 3/8" (70 x 100 x 35)
F.	RCW9	RCW9 -BK	Watch (Collar)	3 1/8" x 3 7/8" x 2 1/4" (78 x 98 x 56)
G.	RCB5	RCB5 -BK	Bracelet/Watch	8 5/8" x 2 1/8" x 1 1/8" (220 x 55 x 30)
H.	RCN7	RCN7 -BK	Necklace	6 7/8" x 4 7/8" x 1 1/4" (176 x 123 x 32)
I.	RCN10	RCN10 -BK	Large Necklace	7 1/2" x 9 1/2" x 1 1/2" (190 x 242 x 38)

Available Color :



White Faux Leather -WH

Black Faux Leather -BK

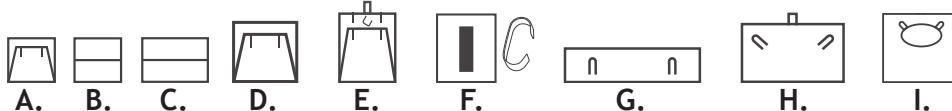

Premium Ribbon Box Collection

* Premium Ribbon Box Collection brings quality and style to the next level. The interior has plush white faux leather that is extremely soft to the touch, while the exterior features a modern weave texture with a glossy finish and a chic satin bow.

Available Colors



Red
-RD



Black
-BK



G. JFN12-Color



D. JFB5-Color



F. JFP9-Color



E. JFC6-Color



Box Collection

8



A. JFE3-Color



B. JFR3-Color



C. JFR5-Color

* 2-piece match packer included.



Red
-RD

Black
-BK

	Red	Black	Description	Size: W x D x H	(mm)
A.	JFE3-RD	JFE3-BK	Earring	2 1/8" x 2 1/2" x 2"	(56 x 64 x 50)
B.	JFR3-RD	JFR3-BK	Ring	2 1/8" x 2 1/2" x 2"	(56 x 64 x 50)
C.	JFR5-RD	JFR5-BK	Double Ring	2 7/8" x 2" x 1 5/8"	(74 x 50 x 42)
D.	JFB5-RD	JFB5-BK	Bracelet	8 5/8" x 2 1/8" x 1"	(219 x 54 x 25)
E.	JFC6-RD	JFC6-BK	Combination	3 1/4" x 3 1/2" x 1 3/8"	(84 x 89 x 36)
F.	JFP9-RD	JFP9-BK	Pendant	2 1/2" x 2 3/4" x 1 3/8"	(64 x 70 x 36)
G.	JFN12-RD	JFN12-BK	Necklace	6 5/8" x 8 1/4" x 1 3/8"	(169 x 210 x 36)



A.



B.



C.

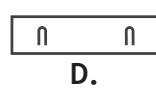

D.



E.



F.

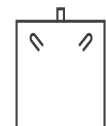

G.

Teal Blue Leatherette Boxes

- * Impressive teal blue leatherette covered box with silver trim.
- * White satin-lined lids and rich velvet padded inserts.
- * 2-piece packer included.



Box Collection

9

Item	Description	Size: W x D x H (mm)
A. AE3 (TB,W)	Earring	1 3/4" x 2" x 1 1/2" (45 x 50 x 37)
B. AR3 (TB,W)	Ring	1 3/4" x 2" x 1 1/2" (45 x 50 x 37)
C. AW8 (TB,W)	Bracelet/Watch	2" x 3 3/4" x 2 3/4" (50 x 95 x 70)
D. AC6 (TB,W)	Ring/Earring	2 5/8" x 3 1/8" x 1 1/8" (67 x 80 x 29)
E. AE7 (TB,W)	Pendant/Earring	2 5/8" x 3 1/8" x 1 1/8" (67 x 80 x 29)
F. AP9 (TB,W)	Pendant	2 5/8" x 3 1/8" x 1 1/8" (67 x 80 x 29)
G. AB5 (TB,W)	Bracelet	8 5/8" x 2 1/8" x 1" (219 x 54 x 25)
H. AV7 (TB,W)	Necklace	4 3/4" x 7 3/8" x 1 1/8" (120 x 188 x 27)



Elegant Sleeve Box Collection

* The Elegant Sleeve Box Collection is covered in a high quality paper with a refined matte finish and the interior is lined with ultra soft light beige faux leather. Furnished with a lovely sleeve packer that is molded for each box and lined with light beige suede.



Available Colors

Blue with Cream Faux Leather -BL
Brown with Cream Faux Leather -BR
Black with Cream Faux Leather -BK



Box Collection

10

KWSR-Color
Ring
1 7/8" x 2" x 1 7/8"H
(47 x 51 x 47mm)

KWSE-Color
Earring
1 7/8" x 2" x 1 1/4"H
(47 x 51 x 31mm)

KWBR-Color
Bracelet/Watch
8 5/8" x 2 1/4" x 7/8"H
(220 x 56 x 23mm)

KECW-Color
Watch (Pillow)
4 1/2" x 4 1/2" x 3"H
(114 x 114 x 76mm)

KEUY-Color
Combo
4 1/2" x 4 1/2" x 2 5/8"H
(114 x 114 x 67mm)

KEBR-Color
Bracelet/Watch
10 1/4" x 2 1/4" x 1 5/8"H
(260 x 56 x 40mm)

NEW

Available Colors



Blue with Cream
Faux Leather
-BL

Brown with Cream
Faux Leather
-BR

Black with Cream
Faux Leather
-BK



Box Collection

11

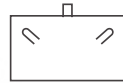

KWPR-Color

Necklace

6 3/8" x 4 3/8" x 1 3/8"H
(162 x 111 x 35mm)

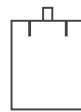

KWLP-Color

Pendant/Earring

3 1/8" x 4 3/8" x 1 1/4"H
(78 x 110 x 32mm)



KWFC-Color

T-Shape Earring

3" x 4 3/8" x 1 1/4"H
(76 x 111 x 32mm)



KWUV-Color

Pendant/Earring

3 3/8" x 3 5/8" x 1 1/4"H
(85 x 93 x 31mm)



KESR-Color

Double Ring

3 1/4" x 3 1/4" x 2"H
(82 x 82 x 51mm)



KEFC-Color

T-Shape Earring

3 1/4" x 3 1/4" x 2"H
(82 x 82 x 51mm)



KEEP-Color

Earring

3 1/4" x 3 1/4" x 2"H
(82 x 82 x 51mm)

Classic Premium Brown Hardwood Boxes

- * Brown Hardwood box with tan faux suede interior.
- * 2-piece packer with protective foam lining included.

Box Collection

12



Satin Brown Hardwood with Tan Faux Suede



2-piece packer with protective foam lining included.

Item	Description	Size: W x D x H	(mm)
A. HWE3 (55)	Earring	2 3/8" x 2" x 1 7/8"	(59 x 51 x 48)
B. HWR3 (55)	Ring	2 3/8" x 2" x 1 7/8"	(58 x 51 x 48)
C. HWR5 (55)	Double Ring	3" x 2" x 1 7/8"	(75 x 50 x 48)
D. HWE9 (55)	Pendant/Earring	3 1/8" x 4" x 1 7/8"	(79 x 103 x 46)
E. HWW8 (55)	Bangle/Watch (Pillow)	3 7/8" x 3 7/8" x 3"	(98 x 98 x 77)
F. HWB5 (55)	Bracelet/Watch	8 3/4" x 2 1/8" x 1 1/4"	(222 x 55 x 33)
G. HWN10 (55)	Large Necklace	7 5/8" x 7 5/8" x 1 3/4"	(194 x 194 x 44)



A.



B.



C.



D.

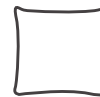

E.



F.

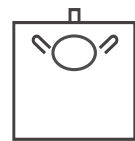

G.

High Veneer Premium Wood Boxes

* High glossy Kona finish wood box with deluxe tan faux suede interior.



Box Collection

13

Item	Description	Size: W x D x H	(mm)
A. RWE3 (64)	Earring	2 1/4" x 2" x 2"	(58 x 50 x 51)
B. RWR3 (64)	Ring	2 3/8" x 2 1/8" x 2 1/4"	(60 x 54 x 57)
C. RWR5 (64)	Double Ring	3" x 2" x 2 1/4"	(76 x 51 x 57)
D. RWE9 (64)	Pendant/Earring	3 1/4" x 4 1/4" x 1 7/8"	(82 x 107 x 47)
E. RWW8 (64)	Watch (Pillow)	4" x 4" x 3 3/8"	(102 x 102 x 86)
F. RWB5 (64)	Bracelet/Watch	8 7/8" x 2 1/4" x 1 3/8"	(225 x 57 x 35)
G. RWN10 (64)	Large Necklace	7 3/4" x 7 3/4" x 2"	(197 x 197 x 51)

Glossy Kona Finish with Tan Faux Suede



2-piece packer with protective foam lining included.

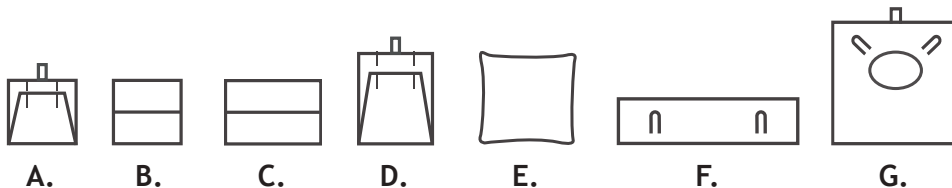

Classic Premium Rosewood Boxes

- * Rosewood box with premium white soft faux leather interior.
- * 2-piece packer with protective foam lining included.



2-piece packer with protective foam lining included.



WW9 (RW)
Deluxe Watch
4 7/8" x 4 7/8" x 3"H
(125 x 125 x 77mm)



WW8 (RW)
Bangle/Watch (Pillow)
3 7/8" x 3 7/8" x 3 1/8"H
(100 x 100 x 78mm)



WN10 (RW)
Large Necklace
7 5/8" x 7 5/8" x 1 3/4"H
(194 x 194 x 43mm)

WE9 (RW)
Pendant/Earring
3 1/8" x 4" x 1 7/8"H
(79 x 102 x 46mm)



WB5 (RW)
Bracelet/Watch
8 3/4" x 2 1/8" x 1 1/4"H
(222 x 55 x 33mm)



Slant angle Ring Box



WR4 (RW)
Ring (Clip)
2 1/4" x 2" x 2"H
(58 x 52 x 52mm)



WR3 (RW)
Ring
2 1/4" x 2" x 2"H
(60 x 52 x 50mm)



WR5 (RW)
Double Ring
3" x 2" x 2"H
(75 x 50 x 50mm)

WE3 (RW)
Earring
2 1/4" x 2" x 2"H
(60 x 52 x 50mm)

Box Collection

14

Rosewood Veneer Premium Wood Boxes

- * Features solid rosewood veneer top and bottom. Come with white velvet lining.

WMN10 (RW)
Large Necklace
7 5/8" x 7 5/8" x 1 3/4"H
(194 x 194 x 45mm)

WMB5 (RW)
Bracelet/Watch
9 7/8" x 2 3/8" x 1 3/8"H
(251 x 60 x 35mm)



2-piece packer with protective foam lining included.



WME9 (RW)
Earring/Pendant
3" x 3" x 1 7/8"H
(76 x 76 x 49mm)



WMR5 (RW)
Double Ring
3 1/8" x 2 3/4" x 2 1/4"H
(80 x 70 x 57mm)



WME3 (RW)
Earring
2 1/8" x 2 1/2" x 2 1/4"H
(56 x 65 x 58mm)



WMR3 (RW)
Ring
2 1/8" x 2 1/2" x 2 1/4"H
(56 x 65 x 58mm)



Fancy Wooden Box Collection



* This lovely new rosewood collection brings together high quality and classic style. Glossy rosewood finish with an extremely supple faux leather interior.



Box Collection

15

Item	Description	Size: W x D x H (mm)
A. WKR3-RW	Ring Slot	2 1/4" x 2" x 2" (57 x 51 x 51)
B. WKR4-RW	Ring Clip	2 1/4" x 2" x 2" (57 x 51 x 51)
C. WKE3-RW	Earring	2 1/4" x 2" x 2" (57 x 51 x 51)
D. WKR5-RW	Double Ring	3 1/8" x 2 3/8" x 1 7/8" (79 x 60 x 47)
E. WKE9-RW	Earring/Pendant	3 1/2" x 3 1/2" x 1 1/2" (89 x 89 x 38)
F. WKP9-RW	Pendant	3 1/2" x 3 1/2" x 1 1/2" (89 x 89 x 38)
G. WKB5-RW	Bracelet	9 3/8" x 2 1/4" x 1 1/2" (238 x 57 x 38)
H. WKW8-RW	Watch (Pillow)	4 1/2" x 4 1/2" x 2 7/8" (114 x 114 x 73)
I. WKN10-RW	Necklace	7 5/8" x 7 5/8" x 1 3/4" (194 x 194 x 44)

Glossy Rosewood Finish with Supple White Faux Leather



* 2-piece packer with protective foam lining included.

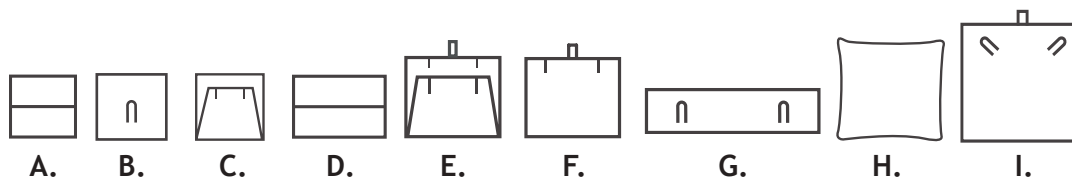

Classic Faux Leather Style Metal Boxes

- * Black or white soft faux leather finished boxes and inserts with white satin lid lining.
- * 2-piece packer included.

Box Collection

16



Available Colors



Black Faux Leather (BK, W, BK) White Faux Leather (W, W)

	Black	White	Description	Size: W x D x H	(mm)
A.	VE3 (BK,W,BK)	VE3 (W,W)	Earring	1 7/8" x 2 1/8" x 1 1/2"	(47 x 54 x 38)
B.	VR3 (BK,W,BK)	VR3 (W,W)	Ring	1 7/8" x 2 1/8" x 1 1/2"	(47 x 54 x 38)
C.	VR5 (BK,W,BK)	VR5 (W,W)	Double Ring	2 3/8" x 2" x 1 1/2"	(60 x 51 x 38)
D.	VE7 (BK,W,BK)	VE7 (W,W)	Earring/Pendant	2 1/4" x 3" x 1 1/4"	(57 x 77 x 30)
E.	VP9 (BK,W,BK)	VP9 (W,W)	Earring/Pendant (Flap)	2 5/8" x 2 5/8" x 1 3/8"	(66 x 66 x 36)
F.	VB5 (BK,W,BK)	VB5 (W,W)	Bracelet/Watch	8" x 2" x 1 1/8"	(203 x 51 x 29)
G.	VN7 (BK,W,BK)	VN7 (W,W)	Necklace	4 1/4" x 7" x 1 5/8"	(108 x 178 x 41)

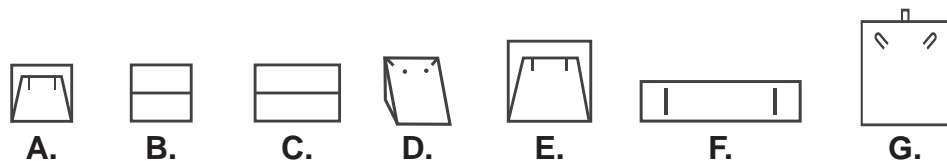

Classic Velvet Metal Boxes with or without Brass Trim

- * Rich velvet finished metal boxes and inserts with white satin lid lining.
- * 2-piece packer included.



Available Box Styles / Available Colors:

No Brass Trim



With Goldtone Brass Trim



	No Trim	with Brass Trim	Description	Size: W x D x H	(mm)
A.	YE3 -Color	SE3 -Color	Earring	1 7/8" x 2 1/8" x 1 1/2"	(47 x 54 x 38)
B.	YR3 -Color	SR3 -Color	Ring	1 7/8" x 2 1/8" x 1 1/2"	(47 x 54 x 38)
C.	YR5 -Color	SR5 -Color	Double Ring	2 3/8" x 2" x 1 1/2"	(60 x 51 x 38)
D.	YE4 -Color	SE4 -Color	Pendant/Earring	2 1/4" x 3" x 1 1/4"	(57 x 77 x 30)
E.	YE5 -Color	SE5 -Color	T-Shape Earring	2 1/4" x 3" x 1 1/4"	(57 x 77 x 30)
F.	YP10 -Color	SP10 -Color	Pendant/Earring (Flap)	2 1/4" x 3" x 1 1/4"	(57 x 77 x 30)
G.	YP9 -Color	SP9 -Color	Pendant/Earring	2 5/8" x 2 5/8" x 1 3/8"	(66 x 66 x 36)
H.	YB5 -Color	SB5 -Color	Bracelet/Watch	8" x 2" x 1 1/8"	(203 x 51 x 29)
I.	YN7 -Color	SN7 -Color	Necklace	4 1/4" x 7" x 1 5/8"	(108 x 178 x 41)



A.



B.



C.



D.



E.



F.



G.



H.



I.

Classic Rectangular Style Leatherette Boxes

- * Leatherette finished boxes featuring gold trim and velvet inserts.
- * 2-piece packer included.

Box Collection

18



Available Colors



Black w/ Black interior
(BK, BK)



Black w/ White and Black interior
(BK, W, BK)



Black w/ White interior
(BK, W)



Red w/ White interior
(R, W)



All White
(W, W)

Item	Description	Size: W x D x H	(mm)
A. LC6F (Color)	Ring/Earring	2 5/8" x 3 1/8" x 1 1/8"	(67 x 80 x 29)
B. LE4 (Color)	T-Shape Earring	2 5/8" x 3 1/8" x 1 1/8"	(67 x 80 x 29)
C. LE6 (Color)	Earring	2 5/8" x 3 1/8" x 1 1/8"	(67 x 80 x 29)
D. LE7 (Color)	Earring/Pendant	2 5/8" x 3 1/8" x 1 1/8"	(67 x 80 x 29)
E. LP9 (Color)	Earring/Pendant	2 5/8" x 3 1/8" x 1 1/8"	(67 x 80 x 29)
F. LP10 (Color)	Large Pendant	2 3/4" x 3 7/8" x 1 3/16"	(70 x 100 x 30)
G. LW10 (Color)	Bangle/Watch	3 3/4" x 3" x 2"	(94 x 76 x 50)
H. LW2 (Color)	Watch w/Pillow	4 1/2" x 3 1/2" x 2"	(114 x 89 x 51)
I. LW9 (Color)	Watch w/Pillow	5 1/4" x 4 1/8" x 2 1/2"	(133 x 105 x 63)
J. LW11 (Color)	Double Watch	5 1/4" x 4 1/8" x 2 1/2"	(133 x 105 x 63)
K. LW7 (Color)	Premium Watch	6" x 4 3/4" x 3 1/4"	(153 x 121 x 83)
L. LN7 (Color)	Necklace	6 1/4" x 4 1/2" x 1 1/4"	(158 x 114 x 31)
M. LV8 (Color)	Necklace	6 1/2" x 6 1/2" x 1 1/4"	(164 x 164 x 30)



A.



B.



C.



D.



E.



F.



G.



H.



I.



J.



K.



L.



M.

* Leatherette finished boxes with gold trim and velvet inserts.
 * 2-piece packer included.



Item	Description	Size: W x D x H (mm)
A. LW4 (Color)	Bangle	1 1/4" x 3 3/4" x 3 1/8" (32 x 94 x 80)
B. LE3 (Color)	Earring	1 3/4" x 2" x 1 1/2" (45 x 50 x 37)
C. LF3 (Color)	Finger Ring	1 3/4" x 2" x 1 1/2" (45 x 50 x 37)
D. LR2 (Color)	Ring (Clip)	1 3/4" x 2" x 1 1/2" (45 x 50 x 37)
E. LR3 (Color)	Ring	1 3/4" x 2" x 1 1/2" (45 x 50 x 37)
F. LR4 (Color)	Ring (High Top)	1 3/4" x 2" x 2" (45 x 51 x 51)
G. LW8 (Color)	Bangle/Watch	2" x 3 3/4" x 2 3/4" (50 x 95 x 70)
H. LR5 (Color)	Double Ring	2 7/8" x 1 7/8" x 1 1/2" (72 x 48 x 38)
I. LV7 (Color)	Necklace	4 3/4" x 7 3/8" x 1 1/8" (120 x 188 x 27)
J. LN12 (Color)	Large Necklace	6 1/4" x 9" x 1 3/4" (158 x 228 x 44)
K. LN10 (Color)	Necklace	7 1/2" x 7 5/8" x 1 1/2" (190 x 194 x 38)
L. LB5 (Color)	Bracelet/Watch	8 5/8" x 2 1/8" x 1" (219 x 54 x 25)

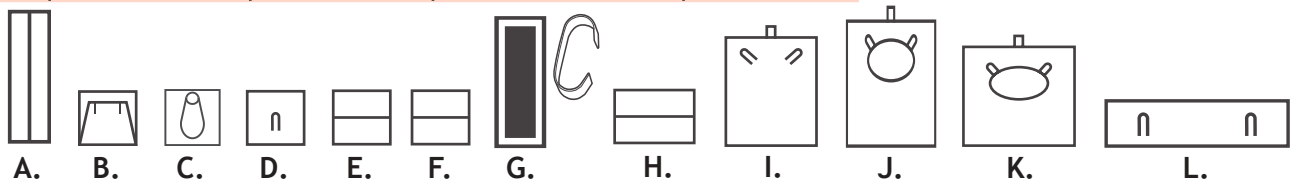

Deluxe Snap-Tab Leatherette Boxes

* Leatherette finished boxes featuring gold trim, snap-tab closure and velvet inserts.



J. BN7 (Color)

I. BC7 (Color)



C. BR2 (Color)



G. BP3 (Color)



F. BR3 (Color)

E. BF3 (Color)



H. BRW (Color)

D. BE3 (Color)



A. BE1 (Color)



B. BR1 (Color)

Box Collection

20

Available Colors



Black w/ White interior (BK, W) Black w/ Black and White interior (BK, W, BK) Black w/ Black interior (BK, BK) Red w/ White interior (R, W) All White (W, W)

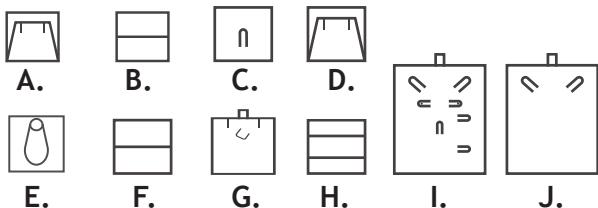

Item	Description	Size: W x D x H (mm)
A. BE1 (Color)	Small Earring	2" x 1 5/8" x 1 3/8" (50 x 43 x 34)
B. BR1 (Color)	Small Ring	2" x 1 5/8" x 1 3/8" (50 x 43 x 34)
C. BR2 (Color)	Ring Clip	2" x 2 1/8" x 1 3/4" (49 x 55 x 46)
D. BE3 (Color)	Earring	2" x 2 1/8" x 1 3/4" (49 x 55 x 46)
E. BF3 (Color)	Finger Ring	2" x 2 1/8" x 1 3/4" (49 x 55 x 46)
F. BR3 (Color)	Large Ring	2" x 2 1/8" x 1 3/4" (49 x 55 x 46)
G. BP3 (Color)	Small Pendant	2" x 2 1/8" x 1 3/4" (49 x 55 x 46)
H. BRW (Color)	Wedding Set	2" x 2 1/8" x 1 3/4" (49 x 55 x 46)
I. BC7 (Color)	Combination Set	5 5/8" x 8 1/8" x 1 1/4" (144 x 206 x 32)
J. BN7 (Color)	Large Necklace	5 5/8" x 8 1/8" x 1 1/4" (144 x 206 x 32)



H. BW8 (Color)



I. BB5 (Color)



G. BW4 (Color)



D. BP9 (Color)



C. BK3 (Color)



F. BC6F (Color)



E. BC6 (Color)



A. BE6 (Color)



* 2-piece packer included.



B. BE9 (Color)



A.



B.



C.



D.



E.



F.



G.



H.

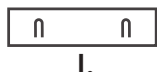

I.

Item	Description	Size: W x D x H (mm)
A. BE6 (Color)	Clip Earring	3 1/2" x 3" x 1 1/2" (89 x 76 x 38)
B. BE9 (Color)	Earring/Pendant	3 1/2" x 3" x 1 1/2" (89 x 76 x 38)
C. BK3 (Color)	3-Slot Ring	3 1/2" x 3" x 1 1/2" (89 x 76 x 38)
D. BP9 (Color)	Large Pendant	3 1/2" x 3" x 1 1/2" (89 x 76 x 38)
E. BC6 (Color)	Ring/Earring Set	3 1/2" x 3" x 1 1/2" (89 x 76 x 38)
F. BC6F (Color)	Ring/Earring set	3 1/2" x 3" x 1 1/2" (89 x 76 x 38)
G. BW4 (Color)	Bangle/Watch	3 1/2" x 3" x 1 1/2" (89 x 76 x 38)
H. BW8 (Color)	Watch/Bangle	3 3/8" x 4" x 2 3/8" (87 x 100 x 60)
I. BB5 (Color)	Bracelet/Watch	8 5/8" x 2" x 1" (219 x 50 x 26)

Soft Flocked Velour Value Boxes

- * Velour finished boxes and inserts.
- * Tuck-in packer included.

Box Collection

22



Available Colors

Red (R, W)

Black (BK, W, BK)

Item	Description	Size: W x D x H (mm)
A. FQ2E (Color)	S. Square Earring	1 3/4" x 1 7/8" x 1 1/2" (45 x 48 x 38)
B. FQ3R (Color)	S. Square Ring	1 3/4" x 1 7/8" x 1 1/2" (45 x 48 x 38)
C. FH1R (Color)	S. Heart Ring	2" x 1 3/4" x 1 1/2" (50 x 43 x 37)
D. FH1E (Color)	S. Heart Earring	2" x 1 3/4" x 1 1/2" (50 x 43 x 37)
E. FQ3E (Color)	L. Square Earring	2" x 2 1/4" x 1 3/8" (50 x 56 x 35)
F. FQ5R (Color)	L. Square Ring	2" x 2 1/4" x 1 1/4" (50 x 56 x 33)
G. FH5R (Color)	L. Heart Ring	2 1/8" x 2 1/4" x 1 5/8" (55 x 58 x 40)

Item	Description	Size: W x D x H (mm)
H. FR9P (Color)	Pendant/Earring	2 3/8" x 3" x 1 1/8" (59 x 73 x 30)
I. FQ4W (Color)	Bangle/Watch	3 3/8" x 3 1/2" x 1 3/4" (84 x 90 x 45)
J. FR6B (Color)	Bracelet/Watch	8 1/2" x 2" x 1" (215 x 50 x 25)
K. FQ10C (Color)	L. Combo.	6 3/8" x 6 3/8" x 1" (162 x 162 x 25)
L. FQ10N (Color)	L. Necklace	6 3/8" x 6 3/8" x 1" (162 x 162 x 25)
M. F747C (Color)	L. Heart Combo.	6 1/2" x 6" x 1 3/8" (165 x 153 x 35)
N. F747 (Color)	L. Heart Necklace	6 1/2" x 6" x 1 3/8" (165 x 153 x 35)



Crystal Style Clear Boxes

- * High quality lucite boxes and black velvet inserts.
- * Individual tuck-in packer included.



BX1011
Bracelet/Watch
8 7/8" x 2" x 1 1/8"H
(225 x 48 x 29mm)



BX1004
Double Ring
2 1/2" x 1 3/4" x 2"H
(65 x 46 x 50mm)



BX1023
Pendant/Earring
2 1/8" x 2 3/4" x 1"H
(54 x 70 x 26mm)



BX1002
Ring
1 7/8" x 1 7/8" x 1 3/4"H
(48 x 48 x 46mm)



BX1010
Ring (Diamond Cut)
1 3/4" x 1 3/4" x 1 3/4"H
(45 x 45 x 45mm)



BX1008
Earring
1 7/8" x 1 7/8" x 1 7/8"H
(47 x 47 x 48mm)

Fancy Flocked Velour Clasped Boxes

- * Velour finished boxes and inserts.
- * Brass finished clasps and corners.
- * Tuck-in packer included.



KUB5 (Color)
Bracelet/Watch
8 3/4" x 2 1/8" x 1 3/8"H
(223x 55 x 35mm)



KUN10 (Color)
Large Necklace
7 1/2" x 6 3/8" x 1 7/8"H
(190 x 162 x 47mm)



KUR5 (Color)
Double Ring
3 1/8" x 2 1/8" x 1 3/4"H
(80 x 53 x 44mm)



KUP9 (Color)
Pendant
2 7/8" x 2 3/4" x 1 3/8"H
(73 x 70 x 34mm)



KUE3 (Color)
Earring
2 1/8" x 2 1/8" x 1 3/4"H
(54 x 54 x 45mm)



KUR3 (Color)
Ring
2 1/8" x 2 1/8" x 1 3/4"H
(54 x 54 x 45mm)

Available Colors



Red
(R, W)



Black
(BK, W, BK)

Universal Gift Boxes

- * Features gold trim lids, velvet inserts and metallic gold bases.
- * The lid is accented with matching metallic-stamped border.



F. 29-423



I. 29-821

J. 29-921



H. 29-751



D. 29-330



G. 29-641



E. 29-331



C. 29-321



B. 29-221



A. 29-222

Box Collection

24



Black Box w/
Black Velvet Insert

	Black with Black Insert	Description	Size: W x D x H	(mm)
A.	29-222	Earring	1 3/4" x 1 3/4" x 1 5/8"	(45 x 45 x 42)
B.	29-221	Universal	2 1/8" x 2 1/8" x 3/4"	(54 x 54 x 18)
C.	29-321	Universal	2 1/2" x 2 1/4" x 1"	(65 x 58 x 27)
D.	29-330	Pendant	2 1/2" x 3 1/2" x 5/8"	(65 x 88 x 17)
E.	29-331	Universal	3" x 3" x 1 1/8"	(77 x 77 x 30)
F.	29-423	Bangle	3 7/8" x 2 1/8" x 2 1/2"	(98 x 55 x 65)
G.	29-641	Universal	3 7/8" x 6 3/8" x 1"	(98 x 161 x 27)
H.	29-751	Universal	4 7/8" x 7 1/8" x 1 1/4"	(124 x 180 x 30)
I.	29-821	Bracelet	8 1/8" x 1 7/8" x 7/8"	(205 x 46 x 23)
J.	29-921	Long Bracelet/Watch	9 7/8" x 2 1/8" x 3/4"	(250 x 55 x 22)



Flower Bow Tie Gift Boxes

* Features linen texture paper boxes, flower bow ties and flocked foam inserts.



H. DK7N -MX



G. DK5B -MX



E. DK5W -MX



D. DK6P -MX



F. DK8W -MX



B. DK2R -MX



C. DK4E -MX



A. DK2E -MX

Box Collection

25

	Assorted Color	Description	Size: W x D x H	(mm)
A.	DK2E -MX	Stud Earring	1 3/4" x 2" x 7/8"	(44 x 51 x 22)
B.	DK2R -MX	Ring	1 1/2" x 1 7/8" x 1 7/8"	(38 x 48 x 48)
C.	DK4E -MX	Earring Tree	2 3/8" x 2 3/8" x 3/4"	(60 x 60 x 20)
D.	DK6P -MX	Pendant	2 1/2" x 2 7/8" x 3/4"	(63 x 73 x 19)
E.	DK5W -MX	Bangle	3 1/2" x 3 1/2" x 1"	(89 x 89 x 25)
F.	DK8W -MX	Bangle	3 1/2" x 2" x 3"	(89 x 51 x 76)
G.	DK5B -MX	Bracelet/Watch	7 7/8" x 1 5/8" x 7/8"	(200 x 41 x 22)
H.	DK7N -MX	Necklace	5" x 7 1/8" x 1 3/8"	(127 x 181 x 35)



All sizes packed in assorted colors



Bow Tie Gift Boxes

* Features shimmer texture paper boxes, bow ties and flocked foam inserts.

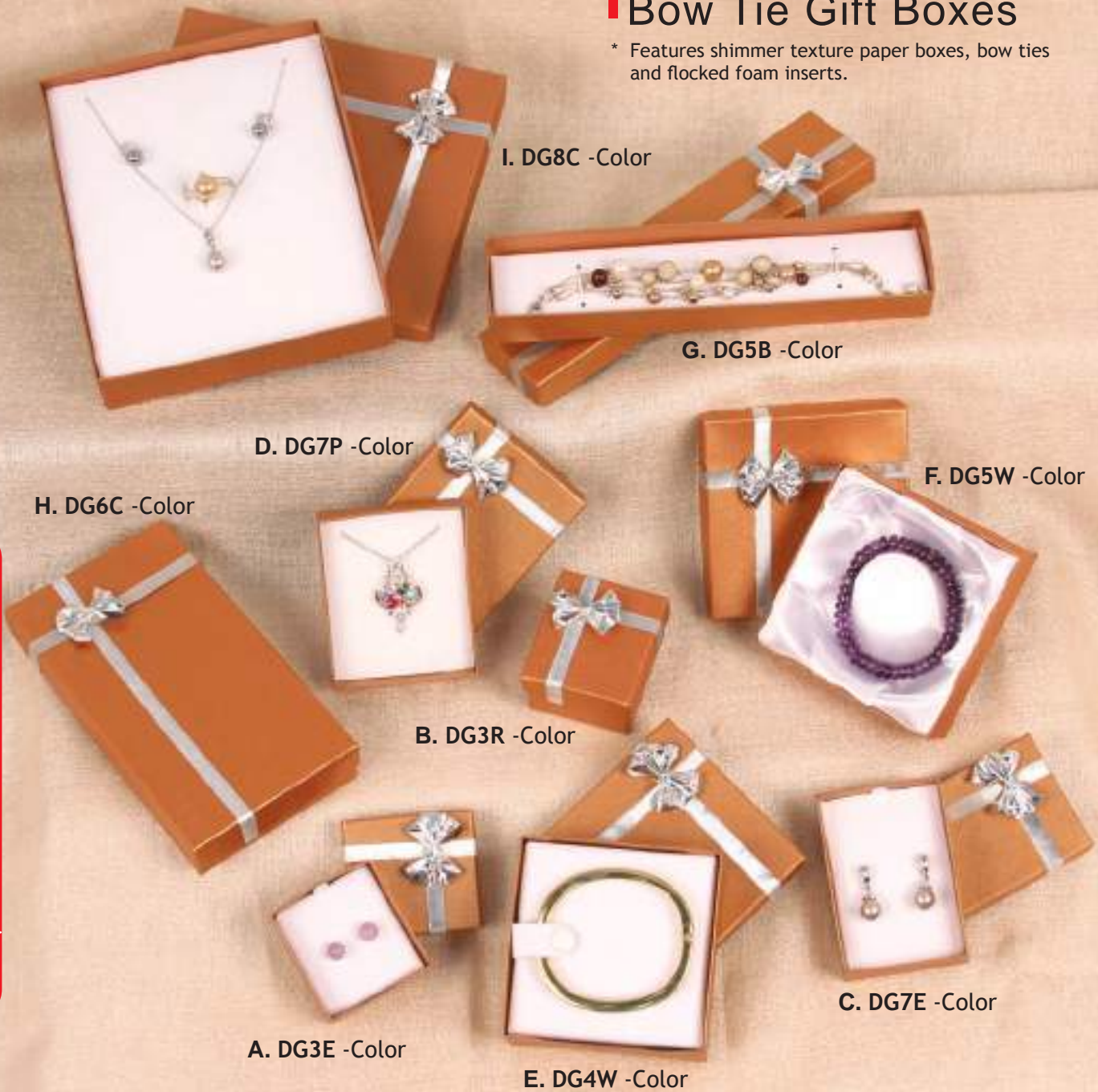

H. DG6C -Color

D. DG7P -Color

I. DG8C -Color

G. DG5B -Color

F. DG5W -Color

B. DG3R -Color

A. DG3E -Color

E. DG4W -Color

C. DG7E -Color

Available Colors



Shimmer Copper -CP



Glossy Teal Blue -TB

	Shimmer Copper	Glossy Teal Blue	Description	Size: W x D x H	(mm)
A.	DG3E -CP	DG3E -TB	Earring	2" x 2 1/8" x 7/8"	(50 x 55 x 23)
B.	DG3R -CP	DG3R -TB	Ring	2" x 2 1/8" x 1 3/8"	(50 x 55 x 35)
C.	DG7E -CP	DG7E -TB	Large Earring	2 1/8" x 3 1/8" x 1"	(55 x 80 x 25)
D.	DG7P -CP	DG7P -TB	Pendant/Earring	2 3/4" x 3 1/8" x 1"	(69 x 80 x 25)
E.	DG4W -CP	DG4W -TB	Bangle (Snap)	3 3/8" x 3 3/8" x 1 3/8"	(85 x 85 x 35)
F.	DG5W -CP	DG5W -TB	Bangle	3 5/8" x 3 5/8" x 1 1/8"	(92 x 92 x 29)
G.	DG5B -CP	DG5B -TB	Bracelet/Watch	8" x 1 7/8" x 1"	(205 x 46 x 25)
H.	DG6C -CP	DG6C -TB	Combination	3 3/8" x 6 1/4" x 1"	(85 x 160 x 25)
I.	DG8C -CP	DG8C -TB	Large Combination	5 1/2" x 6 1/2" x 1 3/8"	(140 x 165 x 35)



■ Linen Bow Tie Gift Boxes

* Features linen texture paper boxes, bow ties and flocked foam inserts.

I. DF8C -Color

H. DF6C -Color

G. DF5B -Color

F. DF5W -Color

B. DF3R -Color

C. DF7E -Color

D. DF7P -Color

A. DF3E -Color

E. DF4W -Color

Linen texture





	Linen Blue	Linen Red	Linen Silver	Description	Size: W x D x H	(mm)
A.	DF3E -BL	DF3E -RD	DF3E -SW	Earring	2" x 2 1/8" x 7/8"	(50 x 55 x 23)
B.	DF3R -BL	DF3R -RD	DF3R -SW	Ring	2" x 2 1/8" x 1 3/8"	(50 x 55 x 35)
C.	DF7E -BL	DF7E -RD	DF7E -SW	Large Earring	2 1/8" x 3 1/8" x 1"	(55 x 80 x 25)
D.	DF7P -BL	DF7P -RD	DF7P -SW	Pendant/Earring	2 3/4" x 3 1/8" x 1"	(69 x 80 x 25)
E.	DF4W -BL	DF4W -RD	DF4W -SW	Bangle (Snap)	3 3/8" x 3 3/8" x 1 3/8"	(85 x 85 x 35)
F.	DF5W -BL	DF5W -RD	DF5W -SW	Bangle	3 5/8" x 3 5/8" x 1 1/8"	(92 x 92 x 29)
G.	DF5B -BL	DF5B -RD	DF5B -SW	Bracelet/Watch	8" x 1 7/8" x 1"	(205 x 46 x 25)
H.	DF6C -BL	DF6C -RD	DF6C -SW	Combination	3 3/8" x 6 1/4" x 1"	(85 x 160 x 25)
I.	DF8C -BL	DF8C -RD	DF8C -SW	Large Combination	5 1/2" x 6 1/2" x 1 3/8"	(140 x 165 x 35)

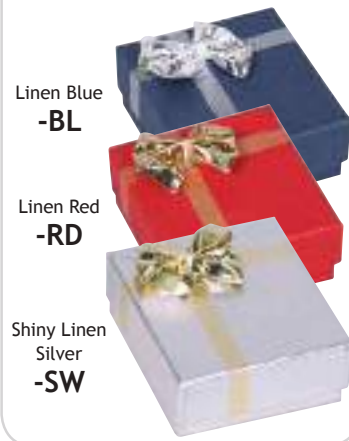

Available Colors

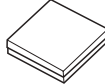
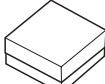
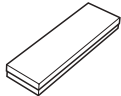
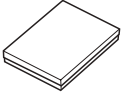
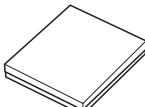
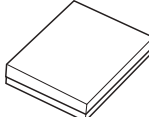
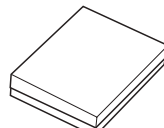

11 Sizes Available for Cotton Filled Boxes:

					
BX2810 -Color 1 7/8" x 1 1/4" x 5/8" H (48 x 33 x 16mm)	BX2811 -Color 2 1/8" x 1 5/8" x 3/4" H (53 x 41 x 18mm)	BX2821 -Color 2 5/8" x 1 1/2" x 1" H (67 x 40 x 25mm)	BX2832 -Color 3 1/4" x 2 1/4" x 1" H (82 x 58 x 26mm)	BX2833 -Color 3 1/2" x 3 1/2" x 1" H (90 x 90 x 26mm)	BX2834 -Color 3 3/4" x 3 3/4" x 2" H (94 x 94 x 52mm)
					
BX2882 -Color 8" x 2" x 1" H (204 x 53 x 25mm)	BX2853 -Color 5 3/8" x 3 7/8" x 1" H (135 x 99 x 25mm)	BX2865 -Color 6 1/8" x 5 1/8" x 1 1/8" H (155 x 129 x 27mm)	BX2875 -Color 7 1/8" x 5 1/8" x 1 1/8" H (180 x 129 x 27mm)	BX2885 -Color 8 1/8" x 5 5/8" x 1 3/8" H (206 x 143 x 35mm)	

Box Collection

28

Rose Gold



BX2810 -RB ~ BX2885 -RB
Available in all 11 sizes

White Swirl



BX2810 -W ~ BX2885 -W
Available in all 11 sizes

Black Swirl



BX2810 -SB ~ BX2885 -SB
Available in all 11 sizes

Gold Texture



BX2810 ~ BX2885
Available in all 11 sizes

Gold Linen

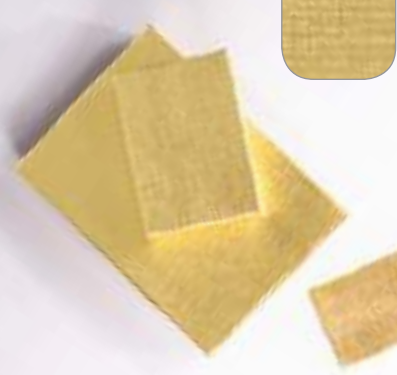

BX2810 -A ~ BX2885 -A
Available in all 11 sizes

Gold Swirl



BX2810 -Y ~ BX2885 -Y
Available in all 11 sizes

Silver Texture



BX2810 -S ~ BX2885 -S
Available in all 11 sizes

Silver Linen



BX2810 -B ~ BX2885 -B
Available in all 11 sizes

Silver Swirl



BX2810 -Z ~ BX2885 -Z
Available in all 11 sizes

Black/White Damask



BX2810 -DF~ BX2885 -DF

Available in all 11 sizes

Kraft Damask



BX2810 -DK ~ BX2885 -DK

Available in all 11 sizes

Assorted Polka Dot

* All sizes packed in assorted colors



BX2810 -PD ~ BX2885 -PD

Available in all 11 sizes

Floral



BX2810 -FL ~ BX2885 -FL

Available in all 11 sizes

Box Collection

29

Glossy Red w/Gold Bow



BX2810 -RK ~ BX2885 -RK

Available in all 11 sizes

Leopard



BX2810 -LD ~ BX2885 -LD

Available in all 11 sizes

Zebra



BX2810 -ZR ~ BX2885 -ZR

Available in all 11 sizes

Glossy White w/Gold Bow



BX2810 -EK ~ BX2885 -EK

Available in all 11 sizes

Teal Blue



BX2810 -TB ~ BX2885 -TB

Available in all 11 sizes





Black Pinstripe



BX2810 -BP ~ BX2885 -BP

Available in all 11 sizes

11 Sizes Available for Cotton Filled Boxes:

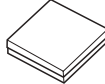
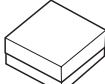
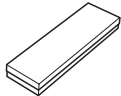
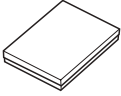
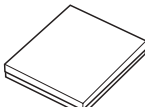
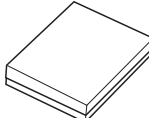
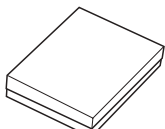
					
BX2710 -Color 1 7/8" x 1 1/4" x 5/8" H (48 x 33 x 16mm)	BX2711 -Color 2 1/8" x 1 5/8" x 3/4" H (53 x 41 x 18mm)	BX2721 -Color 2 5/8" x 1 1/2" x 1" H (67 x 40 x 25mm)	BX2732 -Color 3 1/4" x 2 1/4" x 1" H (82 x 58 x 26mm)	BX2733 -Color 3 1/2" x 3 1/2" x 1" H (90 x 90 x 26mm)	BX2734 -Color 3 3/4" x 3 3/4" x 2" H (94 x 94 x 52mm)
					
BX2782 -Color 8" x 2" x 1" H (204 x 53 x 25mm)	BX2753 -Color 5 3/8" x 3 7/8" x 1" H (135 x 99 x 25mm)	BX2765 -Color 6 1/8" x 5 1/8" x 1 1/8" H (155 x 129 x 27mm)	BX2775 -Color 7 1/8" x 5 1/8" x 1 1/8" H (180 x 129 x 27mm)	BX2785 -Color 8 1/8" x 5 5/8" x 1 3/8" H (206 x 143 x 35mm)	

Available Fancy Cotton Filled Boxes

Brown Kraft



BX2710-K ~ BX2785-K
Available in all 11 sizes

Glossy White



BX2710-E ~ BX2785-E
Available in all 11 sizes

Assorted Pastel Colors

* All sizes packed in 8 assorted colors



BX2710-M ~ BX2785-M
Available in all 11 sizes

Available Colors For Assorted Pastel



Assorted Embossed Fiber

* All sizes packed in assorted colors



BX2710-R ~ BX2785-R
Available in all 11 sizes

Available Colors For Assorted Embossed Fiber

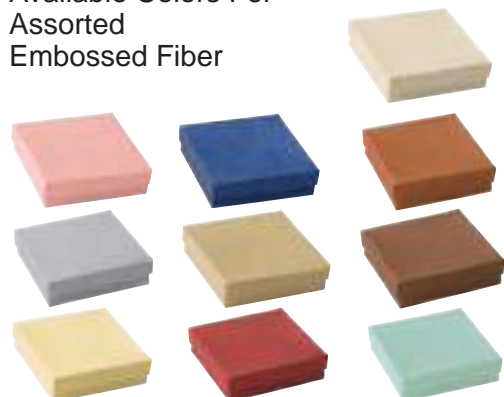

View-Top Cotton Filled Boxes

8 Sizes Available for View-Top Cotton Filled Boxes:



BX2911 -Color
2 1/8" x 1 5/8" x 3/4" H
(53 x 41 x 18mm)



BX2921 -Color
2 5/8" x 1 1/2" x 1" H
(67 x 40 x 25mm)



BX2932 -Color
3 1/4" x 2 1/4" x 1" H
(82 x 58 x 26mm)



BX2933 -Color
3 1/2" x 3 1/2" x 1" H
(90 x 90 x 26mm)

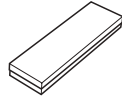

BX2982 -Color
8" x 2" x 1" H
(204 x 53 x 25mm)

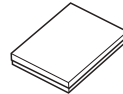

BX2953 -Color
5 3/8" x 3 7/8" x 1" H
(135 x 99 x 25mm)

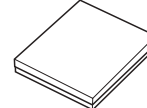

BX2965 -Color
6 1/8" x 5 1/8" x 1 1/8" H
(155 x 129 x 27mm)

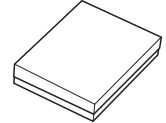

BX2975 -Color
7 1/8" x 5 1/8" x 1 1/8" H
(180 x 129 x 27mm)



BX2911 S ~ BX2975 S
Silver Texture
Available in all 8 sizes



BX2911 ~ BX2975
Gold Texture
Available in all 8 sizes



BX2911 W ~ BX2975 W
White Swirl
Available in all 8 sizes

Cotton Filled Box Assortments

* Assortment pack contains 20 pieces each of the 5 most popular sizes: (#11), (#21), (#32), (#33), (#82).

BX2899
Gold Foil Assortment



BX2899 S
Silver Foil Assortment

BX2799 K
Kraft Assortment



BX2899 W
Swirl White Assortment

Hat Box Collection

* All styles are packed in random assortment of colors and shapes. Package of 48.
Each hat box approximately : 1 5/8" W x 1 5/8" D x 1 1/2" H (41 x 41 x 38mm)

3453HB
Bright Color
printed Polka Dot



3454HB
Chevron



3463HB
Polka Dot Paper
Wrapped



3455HB
Shiny Bright Color



1358HB
Design Paper Wrapped



3462HB
Pastel Paper with
Floral Bow



2489HB
Shinny Metallic



3456HB
Embossed Metallic



Kraft Ring Box

1 3/4" W x 1 3/4" D x 1 5/8" H (44 x 44 x 41mm)



BX-3521-K31
Kraft/White

Assorted Pastel Color Ring Box

Wrapped assorted pastel color paper
1 3/4" W x 1 3/4" D x 1 5/8" H (44 x 44 x 41mm)



Packed in assorted colors



BX-3521-M91
Pastel w/ White

Rose Gold Foil Box

1 3/4" W x 1 3/4" D x 1 5/8" H (44 x 44 x 41mm)



BX-3521-G41
Rose Gold/White

Assorted Embossed Fiber Box

Wrapped assorted embossed fiber paper
1 3/4" W x 1 3/4" D x 1 5/8" H (44 x 44 x 41mm)



Packed in assorted colors



BX-3521-R91
Shiny Embossed/White

Gold Foil Mini Box

1 5/8" W x 1 3/8" D x 1 3/4" H (41 x 35 x 44mm)



380 (GD, W) **380 (GD, BK)**
Gold Texture /White Gold Texture /Black

Square Glossy Box

1 3/4" W x 1 3/4" D x 1 5/8" H (44 x 44 x 41mm)



380-1 (BK, BK)
Glossy Black /Black Foam



380-1 (W, W)
Glossy White /White Foam

Silver Foil Mini Box

1 5/8" W x 1 3/8" D x 1 3/4" H (41 x 35 x 44mm)

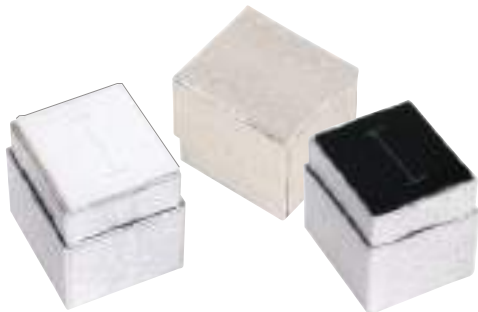

380 (S, W) **380 (S, BK)**
Texture Silver /White Texture Silver /Black

Square Foil Box

1 3/4" W x 1 3/4" D x 1 5/8" H (44 x 44 x 41mm)



380-1 (S, BK)
Silver Foil /Black Foam

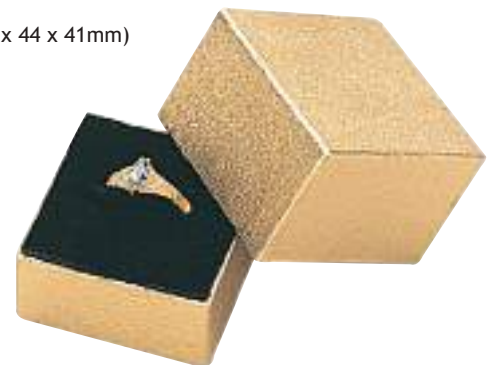

380-1 (GD, BK)
Gold Foil /Black Foam

4 Sizes Available for Shopping Totes:

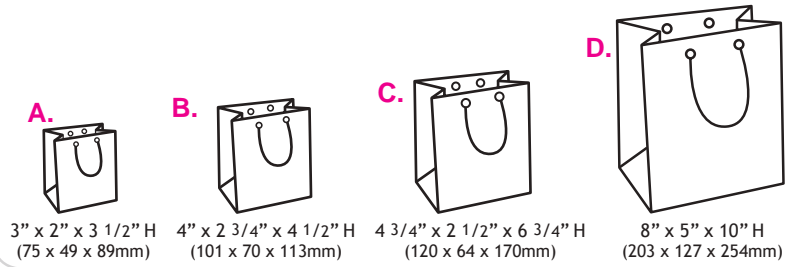

3 Sizes Available for Boxes:

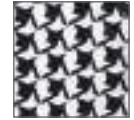
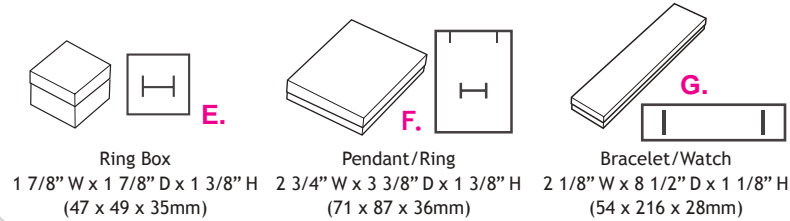

Size	Rose	Chevron (Assorted)	Houndstooth
A.	BX3856	BX4711-MX	BX4731-BK
B.	BX3857	BX4712-MX	BX4732-BK
C.	BX3858	BX4713-MX	BX4733-BK
D.	BX3855	BX4715-MX	BX4735-BK

Size	Rose	Chevron (Assorted)	Houndstooth
E.	DR2R-PK	DR-102R-MX	DR-132R-BK
F.	DR7P-PK	DR-107P-MX	DR-137P-BK
G.	DR5B-PK	DR-105B-MX	DR-135B-BK

Chevron Assorted Totes & Boxes

* Assortment pack in 5 different colors.

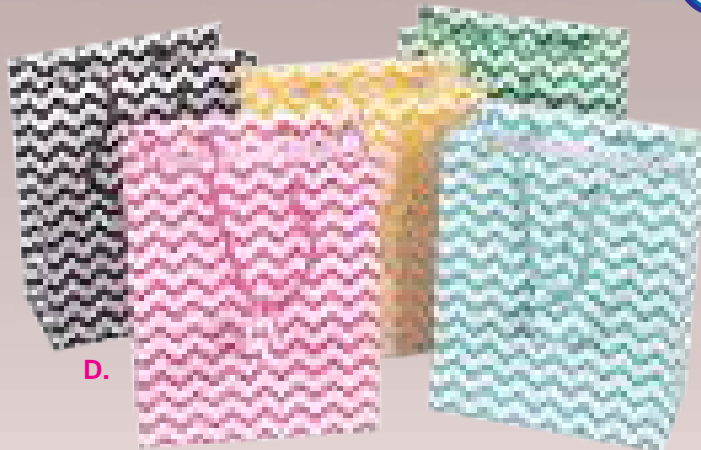

* Available in 4 tote sizes and 3 box styles.



Assortment pack in 5 different colors.



Rose Paper Totes & Boxes

* Available in 4 tote sizes and 3 box styles.



Houndstooth Totes & Boxes



* Available in 4 tote sizes and 3 box styles.



■ OPP Bags with Hanging Header

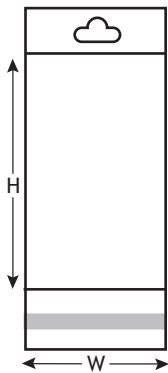

* Clear OPP bag with hanging hole on the white reinforced header, re-sealable flap at the bottom.



Item	Size W x H (mm)
EN610	2" x 2" (51 x 51)
EN611	2" x 3" (51 x 76)
EN612	3" x 4" (76 x 102)
EN613	3" x 5" (76 x 127)
EN614	4" x 6" (102 x 152)
EN616	6" x 9" (152 x 228)
EN617	8" x 10" (203 x 254)
EN643	3" x 3" (76 x 76)

■ Ultra Clear OPP Bags w/Adhesive Seal

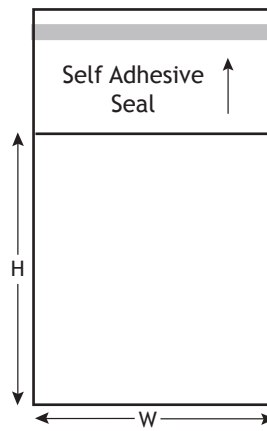

Item	Size W x H (mm)
EN410	2" x 2" (51 x 51)
EN411	2" x 3" (51 x 76)
EN412	3" x 4" (76 x 102)
EN413	3" x 5" (76 x 127)
EN414	4" x 6" (102 x 152)
EN416	6" x 9" (152 x 228)
EN417	8" x 10" (203 x 254)
EN418	1" x 10" (25 x 254)
EN428	2" x 10" (51 x 254)
EN432	1 1/2" x 2" (38 x 51)
EN443	3" x 3" (76 x 76)

■ White-Block Plastic Zipper Bags

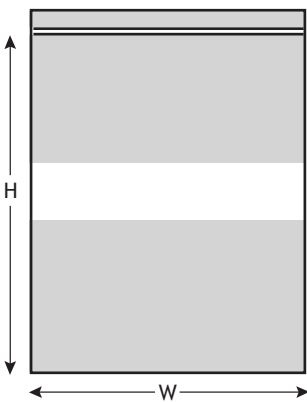

Item	Size W x H (mm)
EN210	2" x 2" (51 x 51)
EN211	2" x 3" (51 x 76)
EN212	3" x 4" (76 x 102)
EN213	3" x 5" (76 x 127)
EN214	4" x 6" (102 x 152)
EN216	6" x 9" (152 x 228)
EN217	8" x 10" (203 x 254)
EN243	3" x 3" (76 x 76)
EN244	4" x 4" (102 x 102)
EN245	5" x 5" (127 x 127)
EN246	6" x 6" (152 x 152)
EN279	9" x 12" (228 x 305)

■ 2-mil Re-Sealable Zipper Bags

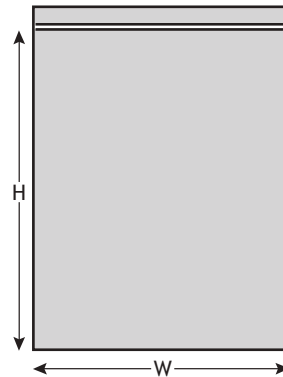

Item	Size W x H (mm)
EN200	2" x 2" (51 x 51)
EN201	2" x 3" (51 x 76)
EN202	3" x 4" (76 x 102)
EN203	3" x 5" (76 x 127)
EN204	4" x 6" (102 x 152)
EN205	2" x 8" (51 x 203)
EN206	6" x 9" (152 x 228)
EN207	8" x 10" (203 x 254)
EN208	5" x 8" (127 x 203)
EN220	1" x 1" (25 x 25)
EN221	1 1/2" x 1 1/2" (38 x 38)
EN222	1 1/2" x 2" (38 x 51)
EN223	3" x 3" (76 x 76)
EN224	4" x 4" (102 x 102)
EN225	5" x 5" (127 x 127)
EN226	6" x 6" (152 x 152)
EN269	9" x 12" (228 x 305)

All Shopping Totes Available in 4 Sizes :



A.
3" x 2" x 3 1/2" H
(75 x 49 x 89mm)

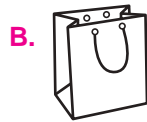

B.
4" x 2 3/4" x 4 1/2" H
(101 x 70 x 113mm)

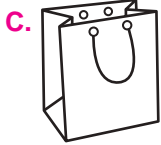

C.
4 3/4" x 2 1/2" x 6 3/4" H
(120 x 64 x 170mm)

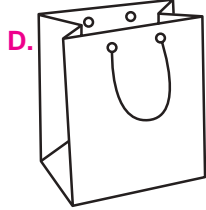

D.
8" x 5" x 10" H
(203 x 127 x 254mm)



Spot Coating Finish Tote



Butterfly Spot Coating Tote

Size Butterfly Spot Coating

A.	BX3856 -BF
B.	BX3857 -BF
C.	BX3858 -BF
D.	BX3855 -BF



Leopard Spot Coating Tote

Size Leopard Spot Coating

A.	BX3856 -LD
B.	BX3857 -LD
C.	BX3858 -LD
D.	BX3855 -LD



Polka Dot Spot Coating Tote

Size Polka Dot Spot Coating

A.	BX4721 -BK
B.	BX4722 -BK
C.	BX4723 -BK
D.	BX4725 -BK

Nature Style Tote



Burlap Print Matte Tote

Size Burlap

A.	BX4751 -N3
B.	BX4752 -N3
C.	BX4753 -N3
D.	BX4755 -N3



White Butterfly Tote

Size White Butterfly

A.	BX3876 -KW
B.	BX3877 -KW
C.	BX3878 -KW
D.	BX3875 -KW



Coffee Butterfly Kraft Tote

Size Coffee Butterfly

A.	BX3876 -KC
B.	BX3877 -KC
C.	BX3878 -KC
D.	BX3875 -KC



Green Kraft Butterfly Tote

Size Green Kraft Tote

A.	BX3876 -GN
B.	BX3877 -GN
C.	BX3878 -GN
D.	BX3875 -GN

Fancy Glossy Tote



Pink Polka Dot / Chevron Glossy

Size	Pink
A.	BX4741 -PK
B.	BX4742 -PK
C.	BX4743 -PK
D.	BX4745 -PK



Turquoise Polka Dot / Chevron Glossy

Size	Turquoise
A.	BX4741 -TQ
B.	BX4742 -TQ
C.	BX4743 -TQ
D.	BX4745 -TQ



Coral Polka Dot / Chevron Glossy

Size	Coral
A.	BX4741 -CA
B.	BX4742 -CA
C.	BX4743 -CA
D.	BX4745 -CA



Damask Glossy Tote

Size	Damask White
A.	BX4701 -DK
B.	BX4702 -DK
C.	BX4703 -DK
D.	BX4705 -DK



Houndstooth Glossy Tote

Size	Houndstooth
A.	BX4731 -BK
B.	BX4732 -BK
C.	BX4733 -BK
D.	BX4735 -BK



Zebra Glossy Tote

Size	Zebra
A.	BX4701
B.	BX4702
C.	BX4703
D.	BX4705

Assorted Chevron Totes



Glossy Red Bow Tote

Size	Glossy Red Bow
A.	BX1800
B.	BX1808
C.	BX1800-1
D.	BX1808-2



Black

Assortment pack in 5 different colors.

Yellow

Green

Pink

Teal Blue

Glossy Mix Chevron

Size	Mix
A.	BX4711-MX
B.	BX4712-MX
C.	BX4713-MX
D.	BX4715-MX

All Shopping Totes Available in 4 Sizes :

A.



3" x 2" x 3 1/2" H
(75 x 49 x 89mm)

B.



4" x 2 3/4" x 4 1/2" H
(101 x 70 x 113mm)

C.

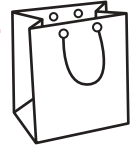

4 3/4" x 2 1/2" x 6 3/4" H
(120 x 64 x 170mm)

D.

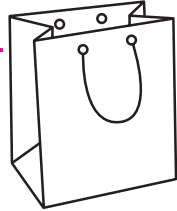

8" x 5" x 10" H
(203 x 127 x 254mm)



■ Matte Finish Solid Color Tote



Dark Brown Matte Finish

Size	Dark Brown Matte
A.	BX3976 -DB
B.	BX3977 -DB
C.	BX3978 -DB
D.	BX3975 -DB



Grey Matte Finish

Size	Grey Matte
A.	BX3976 -GR
B.	BX3977 -GR
C.	BX3978 -GR
D.	BX3975 -GR



Pink Matte Finish

Size	Pink Matte
A.	BX3976 -PK
B.	BX3977 -PK
C.	BX3978 -PK
D.	BX3975 -PK

■ Glossy Finish Solid Color Tote



Glossy Black

Size	Glossy Black
A.	BX3966 -BK
B.	BX3967 -BK
C.	BX3968 -BK
D.	BX3970 -BK

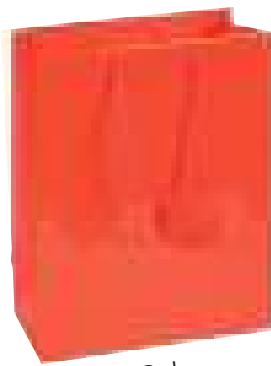

Glossy Red

Size	Glossy Red
A.	BX3966 -RD
B.	BX3967 -RD
C.	BX3968 -RD
D.	BX3970 -RD



Glossy Teal

Size	Glossy Teal
A.	BX3966 -TB
B.	BX3967 -TB
C.	BX3968 -TB
D.	BX3970 -TB



Glossy White

Size	Glossy White
A.	BX3966 -WH
B.	BX3967 -WH
C.	BX3968 -WH
D.	BX3970 -WH

Gold Metallic Tote

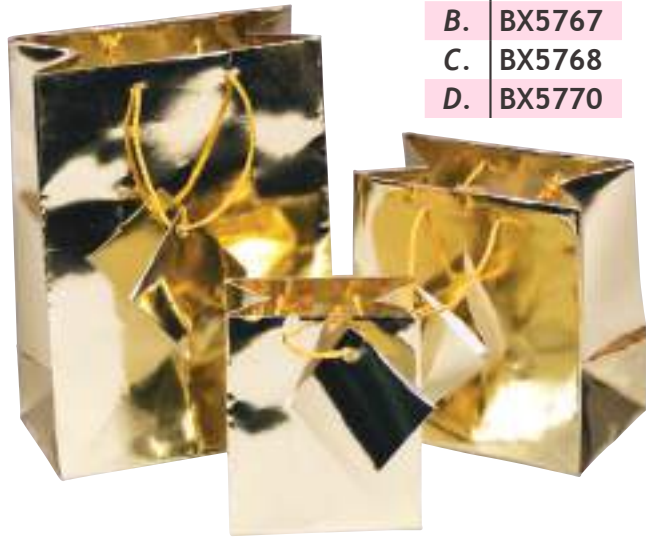

Size	Gold Metallic
A.	BX5766
B.	BX5767
C.	BX5768
D.	BX5770

Silver Metallic Tote



Size	Silver Metallic
A.	BX6766
B.	BX6767
C.	BX6768
D.	BX6770

Packed in assorted metallic colors



Size	Assorted Metallic
A.	BX1802
B.	BX1803
C.	BX1802-1
D.	BX1803-2



Assorted Metallic Tote

Assorted Pastel Tote Bag

- * Packed in Assorted Colors
- * Assortment packed in 8 different colors.



Size	Assorted Pastel
A.	BX3956 -MX
B.	BX3957 -MX
C.	BX3958 -MX
D.	BX3960 -MX

Houndstooth Pattern Paper Bags



Size	Houndstooth	Size	Houndstooth
4" x 6"	EN037-BK	6" x 9"	EN035-BK
5" x 7"	EN036-BK	8 1/2" x 11"	EN034-BK

Chevron Pattern Paper Bags

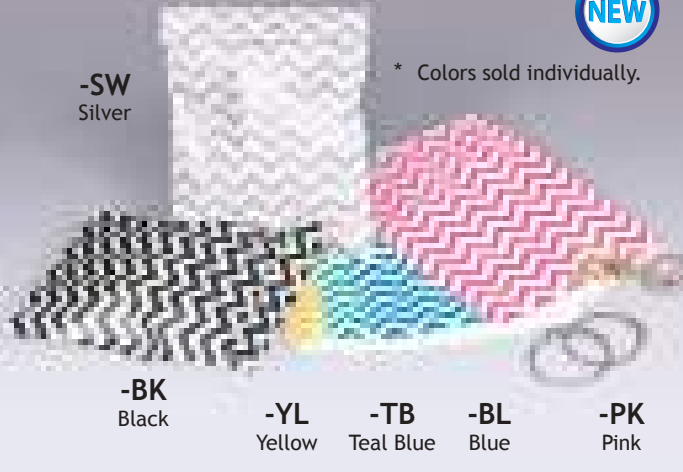

Size	Chevron	Size	Chevron
4" x 6"	EN017 -color	6" x 9"	EN015 -color
5" x 7"	EN016 -color	8 1/2" x 11"	EN014 -color

Trellis Design Paper Bags



Size	Trellis
4" x 6"	EN047 -SW
5" x 7"	EN046 -SW
6" x 9"	EN045 -SW
8 1/2" x 11"	EN044 -SW

Polka Dot Paper Bags



Red Polka Dot		Silver Polka Dot	
Size	Red	Size	Silver
4" x 6"	EN057 -RD	4" x 6"	EN057 -SW
5" x 7"	EN056 -RD	5" x 7"	EN056 -SW
6" x 9"	EN055 -RD	6" x 9"	EN055 -SW
8 1/2" x 11"	EN054 -RD	8 1/2" x 11"	EN054 -SW

White Paper Bags



Size	White Bags	Size	White Bags
12" x 15"	EN002-WH	6" x 9"	EN005-WH
10" x 13"	EN003-WH	5" x 7"	EN006-WH
8 1/2" x 11"	EN004-WH	4" x 6"	EN007-WH

Kraft Paper Bags



Size	Kraft Bags	Size	Kraft Bags
12" x 15"	EN002-KT	6" x 9"	EN005-KT
10" x 13"	EN003-KT	5" x 7"	EN006-KT
8 1/2" x 11"	EN004-KT	4" x 6"	EN007-KT

Pink Flower Paper Bags



Size	Pink Flower	Size	Pink Flower
4" x 6"	EN077	6" x 9"	EN075
5" x 7"	EN076	8 1/2" x 11"	EN074

Snake Pattern Paper Bags



Size	Snake	Size	Snake
4" x 6"	EN087	6" x 9"	EN085
5" x 7"	EN086	8 1/2" x 11"	EN084

Zebra Paper Bags



Size	Zebra	Size	Zebra
4" x 6"	EN097	6" x 9"	EN095
5" x 7"	EN096	8 1/2" x 11"	EN094

Damask Paper Bags



Size	Damask	Size	Damask
4" x 6"	EN027	6" x 9"	EN025
5" x 7"	EN026	8 1/2" x 11"	EN024

Gold/Silver Tone Paper Bags



Gold Tone		Silver Tone	
Size	Item	Size	Item
4" x 6"	EN117	4" x 6"	EN127
5" x 7"	EN116	5" x 7"	EN126
6" x 9"	EN115	6" x 9"	EN125
8 1/2" x 11"	EN114	8 1/2" x 11"	EN124

Lepoard Paper Bags



Size	Lepoard	Size	Lepoard
4" x 6"	EN197	6" x 9"	EN195
5" x 7"	EN196	8 1/2" x 11"	EN194

Organza Cinch

* Pull on strings to close pouch
 * Open size: 10" Dia (254 Dia. mm)

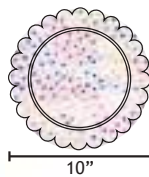

PH-1341-WH
 Multi Colored Heart Organza Pouch



PH-1351-WB
 White w/ Black Damask



PH-1351-BT
 Black w/ Gold Damask



PH-1391-WT
 White /Silver Star Organza



PH-1391-BT
 Black w/ Gold Star



PH-1381-BB
 Black w/ Black Polka Dot



PH-1381-WB
 White w/ Black Polka Dot



PH-1311-BB
 Baby Blue w/ Shiny Dot



PH-1311-YL
 Yellow w /Shiny Dot



PH-1311-PR
 Purple w/ Shiny Dot

■ Reversible Satin Cinch

* Open Size: 10" Dia. (254 Dia. mm)



BX1408-MX
Assorted Satin Cinch



■ Assorted Solid Colors Organza Cinch

7 1/2" x 5 1/2" + 3" Top
(191 x 140 + 76mm)



BX1412 (MX)
Packed in assorted colors



■ Assorted Stripes Organza Cinch



PH-1321-MX
Assorted Stripes Organza Cinch

Open Size: 10" Dia.
(254 Dia. mm)

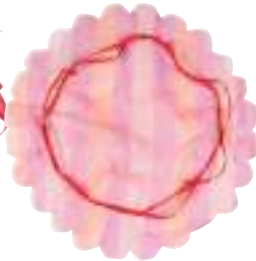

■ Assorted Floral Organza Cinch

7 1/2" x 5 1/2" + 3" Top
(191 x 140 + 76mm)



BX1414 (MX)
Packed in assorted colors



Open Size: 10" Dia. (254 Dia. mm)

■ Animal-Printed Furry Pouches



* Interior pockets to store smaller items.
* Padded base for extra protection.



BX1402 -ZR
Zebra Pouch



BX1402 -LD
Leopard Pouch

Open Size: 10" Dia. (254 Dia. mm)

■ Silky Brocade Cinch Pouches



* Interior pockets to store smaller items.
* Padded base for extra protection.



BX1402D -BK
Black



BX1402D -GN
Green



BX1402D -RD
Red

Fancy Drawstring Pouches

* Ready to display package for all flat pouch collections.



Pouches come in package of 12 pc per pack.

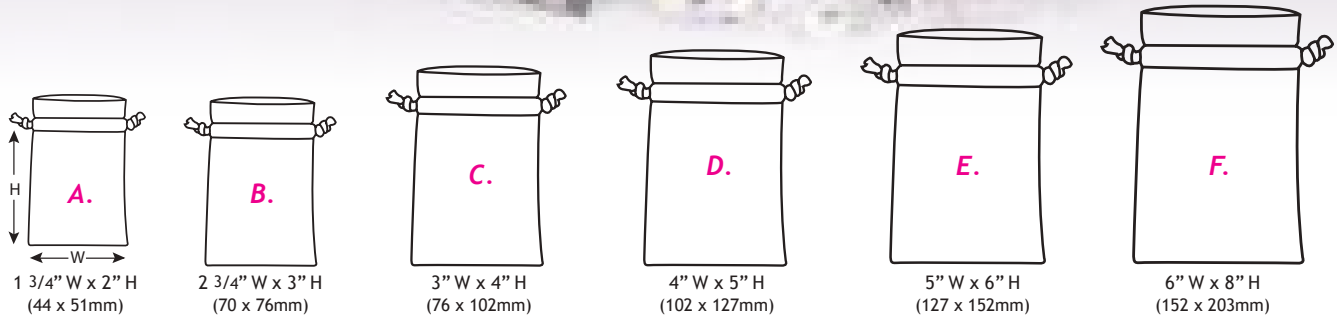

 <p>NEW</p> <p>Multi-Colored Heart</p> <table border="1"> <thead> <tr> <th>Size</th> <th>Item</th> </tr> </thead> <tbody> <tr><td>A.</td><td>PH-1241-WH</td></tr> <tr><td>B.</td><td>PH-1242-WH</td></tr> <tr><td>C.</td><td>PH-1243-WH</td></tr> <tr><td>D.</td><td>PH-1244-WH</td></tr> </tbody> </table>	Size	Item	A.	PH-1241-WH	B.	PH-1242-WH	C.	PH-1243-WH	D.	PH-1244-WH	 <p>NEW</p> <p>Black w/ Black Polka Dot</p> <table border="1"> <thead> <tr> <th>Size</th> <th>Item</th> </tr> </thead> <tbody> <tr><td>A.</td><td>PH-1281-BB</td></tr> <tr><td>B.</td><td>PH-1282-BB</td></tr> <tr><td>C.</td><td>PH-1283-BB</td></tr> <tr><td>D.</td><td>PH-1284-BB</td></tr> <tr><td>F.</td><td>PH-1286-BB</td></tr> </tbody> </table>	Size	Item	A.	PH-1281-BB	B.	PH-1282-BB	C.	PH-1283-BB	D.	PH-1284-BB	F.	PH-1286-BB	 <p>NEW</p> <p>White w/ Black Polka Dot</p> <table border="1"> <thead> <tr> <th>Size</th> <th>Item</th> </tr> </thead> <tbody> <tr><td>A.</td><td>PH-1281-WB</td></tr> <tr><td>B.</td><td>PH-1282-WB</td></tr> <tr><td>C.</td><td>PH-1283-WB</td></tr> <tr><td>D.</td><td>PH-1284-WB</td></tr> <tr><td>F.</td><td>PH-1286-WB</td></tr> </tbody> </table>	Size	Item	A.	PH-1281-WB	B.	PH-1282-WB	C.	PH-1283-WB	D.	PH-1284-WB	F.	PH-1286-WB
Size	Item																																			
A.	PH-1241-WH																																			
B.	PH-1242-WH																																			
C.	PH-1243-WH																																			
D.	PH-1244-WH																																			
Size	Item																																			
A.	PH-1281-BB																																			
B.	PH-1282-BB																																			
C.	PH-1283-BB																																			
D.	PH-1284-BB																																			
F.	PH-1286-BB																																			
Size	Item																																			
A.	PH-1281-WB																																			
B.	PH-1282-WB																																			
C.	PH-1283-WB																																			
D.	PH-1284-WB																																			
F.	PH-1286-WB																																			
 <p>White w/ Silver Stars</p> <table border="1"> <thead> <tr> <th>Size</th> <th>Item</th> </tr> </thead> <tbody> <tr><td>A.</td><td>BX1291 (WT)</td></tr> <tr><td>B.</td><td>BX1292 (WT)</td></tr> <tr><td>C.</td><td>BX1293 (WT)</td></tr> <tr><td>D.</td><td>BX1294 (WT)</td></tr> <tr><td>E.</td><td>BX1294-1 (WT)</td></tr> </tbody> </table>	Size	Item	A.	BX1291 (WT)	B.	BX1292 (WT)	C.	BX1293 (WT)	D.	BX1294 (WT)	E.	BX1294-1 (WT)	 <p>White w/ Black Damask</p> <table border="1"> <thead> <tr> <th>Size</th> <th>Item</th> </tr> </thead> <tbody> <tr><td>A.</td><td>PH-1251 -WB</td></tr> <tr><td>B.</td><td>PH-1252 -WB</td></tr> <tr><td>C.</td><td>PH-1253 -WB</td></tr> <tr><td>D.</td><td>PH-1254 -WB</td></tr> </tbody> </table>	Size	Item	A.	PH-1251 -WB	B.	PH-1252 -WB	C.	PH-1253 -WB	D.	PH-1254 -WB	 <p>Metallic Silver</p> <table border="1"> <thead> <tr> <th>Size</th> <th>Item</th> </tr> </thead> <tbody> <tr><td>A.</td><td>BX1270-1</td></tr> <tr><td>B.</td><td>BX1272</td></tr> <tr><td>C.</td><td>BX1273</td></tr> <tr><td>D.</td><td>BX1274</td></tr> </tbody> </table>	Size	Item	A.	BX1270-1	B.	BX1272	C.	BX1273	D.	BX1274		
Size	Item																																			
A.	BX1291 (WT)																																			
B.	BX1292 (WT)																																			
C.	BX1293 (WT)																																			
D.	BX1294 (WT)																																			
E.	BX1294-1 (WT)																																			
Size	Item																																			
A.	PH-1251 -WB																																			
B.	PH-1252 -WB																																			
C.	PH-1253 -WB																																			
D.	PH-1254 -WB																																			
Size	Item																																			
A.	BX1270-1																																			
B.	BX1272																																			
C.	BX1273																																			
D.	BX1274																																			
 <p>Black w/ Gold Stars</p> <table border="1"> <thead> <tr> <th>Size</th> <th>Item</th> </tr> </thead> <tbody> <tr><td>A.</td><td>BX1291 (BT)</td></tr> <tr><td>B.</td><td>BX1292 (BT)</td></tr> <tr><td>C.</td><td>BX1293 (BT)</td></tr> <tr><td>D.</td><td>BX1294 (BT)</td></tr> <tr><td>E.</td><td>BX1294-1 (BT)</td></tr> </tbody> </table>	Size	Item	A.	BX1291 (BT)	B.	BX1292 (BT)	C.	BX1293 (BT)	D.	BX1294 (BT)	E.	BX1294-1 (BT)	 <p>Black w/ Gold Damask</p> <table border="1"> <thead> <tr> <th>Size</th> <th>Item</th> </tr> </thead> <tbody> <tr><td>A.</td><td>PH-1251 -BT</td></tr> <tr><td>B.</td><td>PH-1252 -BT</td></tr> <tr><td>C.</td><td>PH-1253 -BT</td></tr> <tr><td>D.</td><td>PH-1254 -BT</td></tr> </tbody> </table>	Size	Item	A.	PH-1251 -BT	B.	PH-1252 -BT	C.	PH-1253 -BT	D.	PH-1254 -BT	 <p>Metallic Gold</p> <table border="1"> <thead> <tr> <th>Size</th> <th>Item</th> </tr> </thead> <tbody> <tr><td>A.</td><td>BX1260-1</td></tr> <tr><td>B.</td><td>BX1262</td></tr> <tr><td>C.</td><td>BX1263</td></tr> <tr><td>D.</td><td>BX1264</td></tr> </tbody> </table>	Size	Item	A.	BX1260-1	B.	BX1262	C.	BX1263	D.	BX1264		
Size	Item																																			
A.	BX1291 (BT)																																			
B.	BX1292 (BT)																																			
C.	BX1293 (BT)																																			
D.	BX1294 (BT)																																			
E.	BX1294-1 (BT)																																			
Size	Item																																			
A.	PH-1251 -BT																																			
B.	PH-1252 -BT																																			
C.	PH-1253 -BT																																			
D.	PH-1254 -BT																																			
Size	Item																																			
A.	BX1260-1																																			
B.	BX1262																																			
C.	BX1263																																			
D.	BX1264																																			

Classic Drawstring Pouches

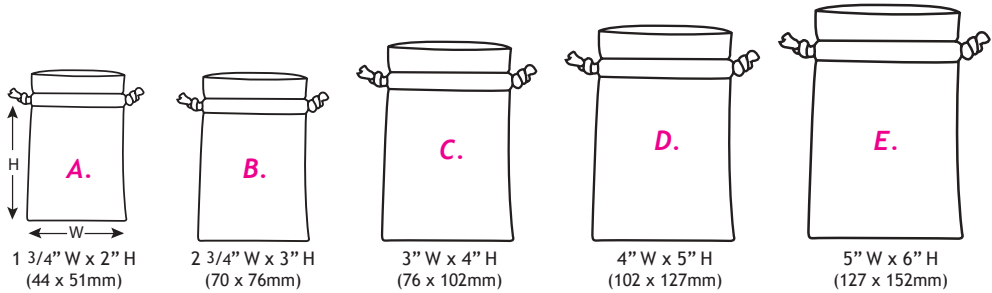

Bag & Pouch Collection

45

NEW Gold Taffeta with Black Damask

Size	Item
A.	PH-1181-GB
B.	PH-1182-GB
C.	PH-1183-GB
D.	PH-1184-GB

NEW White Floral Fabric

Size	Item
A.	PH-1171-WH
B.	PH-1172-WH
C.	PH-1173-WH
D.	PH-1174-WH

NEW Blue Floral Fabric

Size	Item
A.	PH-1171-BL
B.	PH-1172-BL
C.	PH-1173-BL
D.	PH-1174-BL

Economy Black Velvet

Size	Item
A.	BX1231
B.	BX1232
C.	BX1233
D.	BX1234

NEW Teal Blue Suede

Size	Item
A.	PH-1141-TB
B.	PH-1142-TB
C.	PH-1143-TB
D.	PH-1144-TB

NEW Orange Suede

Size	Item
A.	PH-1141-OR
B.	PH-1142-OR
C.	PH-1143-OR
D.	PH-1144-OR

Deluxe Black Velvet

Size	Item
A.	BX1201
B.	BX1202
C.	BX1203
D.	BX1204

Deluxe Red Velvet

Size	Item
A.	BX1201 (RD)
B.	BX1202 (RD)
C.	BX1203 (RD)
D.	BX1204 (RD)

NEW Turquoise Faux Leather

Size	Item
A.	PH-1161-TQ
B.	PH-1162-TQ
C.	PH-1163-TQ
D.	PH-1164-TQ

Furry Zebra

Size	Item
A.	BX1231 -ZR
B.	BX1232 -ZR
C.	BX1233 -ZR
D.	BX1234 -ZR
E.	BX1235 -ZR

Furry Leopard

Size	Item
A.	BX1231 -LD
B.	BX1232 -LD
C.	BX1233 -LD
D.	BX1234 -LD
E.	BX1235 -LD

NEW Steel Grey Faux Leather

Size	Item
A.	PH-1161-SG
B.	PH-1162-SG
C.	PH-1163-SG
D.	PH-1164-SG

Available Sizes for Drawstring Pouches :



Ready to display package for all of our flat pouch collections.

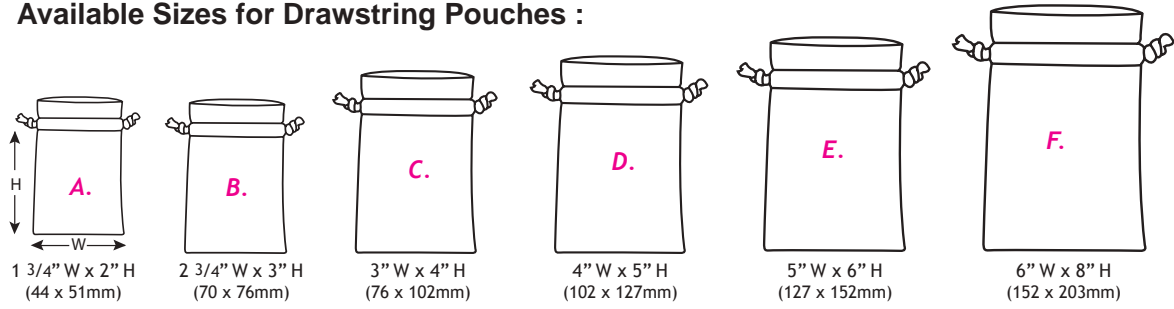

Assorted Organza Drawstring Pouches

* All sizes packed in color assortments



Assorted Fancy Organza

Size	Item
A.	BX1295 (MX)
B.	BX1296 (MX)
C.	BX1297 (MX)
D.	BX1298 (MX)
E.	BX1298-1 (MX)
F.	BX1298-2 (MX)



Assorted Plaid Organza

Size	Item
A.	PH-1221 -MX
B.	PH-1222 -MX
C.	PH-1223 -MX
D.	PH-1224 -MX
E.	PH-1225 -MX
F.	PH-1226 -MX

Bag & Pouch Collection

46

Assorted Solid Color Satin



Size	Item
A.	BX1231 (MX)
B.	BX1232 (MX)
C.	BX1233 (MX)
D.	BX1234 (MX)
E.	BX1235 (MX)
F.	BX1236 (MX)



Assorted Solid Color Organza

Size	Item
A.	BX1291 (MX)
B.	BX1292 (MX)
C.	BX1293 (MX)
D.	BX1294 (MX)
E.	BX1294-1 (MX)
F.	BX1294-2 (MX)

Solid Organza Drawstring Pouches

* Solid organza drawstring pouches are available in a wide variety of colors, choose the one that best suits your jewelry.

Size	Solid Organza Pouch
A.	BX1291 (Color)
B.	BX1292 (Color)
C.	BX1293 (Color)
D.	BX1294 (Color)
E.	BX1294-1 (Color)
F.	BX1294-2 (Color)

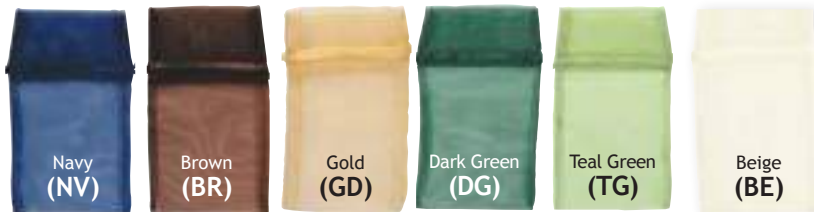

Assorted Silver Polka Dot Pouches

* All sizes packed in assorted colors.



Assorted Silver Polka Dot

	Size	Item
A.	1 3/4" x 2"	PH-1281-SMX
B.	2 3/4" x 3"	PH-1282-SMX
C.	3" x 4"	PH-1283-SMX
D.	4" x 5"	PH-1284-SMX

Assorted Metallic Pouches

* All sizes packed in assorted colors.



Assorted Metallic

	Size	Item
C.	3" x 4"	PH-1913-MX
D.	4" x 5"	PH-1914-MX
E.	5" x 6"	PH-1915-MX
F.	6" x 8"	PH-1916-MX

Assorted Butterfly Organza Pouches



Silver Butterfly

	Size	Item
A.	1 3/4" x 2"	PH-1261-SM
B.	2 3/4" x 3"	PH-1262-SM
C.	3" x 4"	PH-1263-SM
D.	4" x 5"	PH-1264-SM



Gold Butterfly

	Size	Item
A.	1 3/4" x 2"	PH-1261-GM
B.	2 3/4" x 3"	PH-1262-GM
C.	3" x 4"	PH-1263-GM
D.	4" x 5"	PH-1264-GM

Tulip Top Organza Pouches

* Available in 3 different styles.
* Tie the top to close them.



3" W x 5 1/4" H (76 x 133mm)



Pouches come in packages of 1DZ / PK



BX1351 (MX)
Mix Color Organza

BX1351 (BT)
Black Organza w/Gold Stars

BX1351 (WT)
White Organza w/Silver Stars

Available Sizes for Presentation Folders :

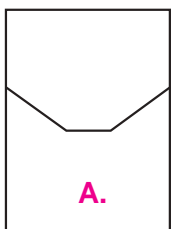

A.
6" W x 8 1/4" H
(150 x 210mm)

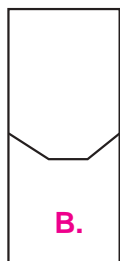

B.
4 1/4" W x 9 1/2" H
(110 x 240mm)

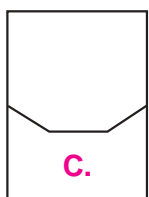

C.
5 1/2" W x 7 1/4" H
(140 x 185mm)

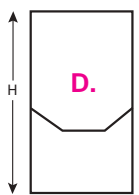

D.
4 1/4" W x 7" H
(110 x 180mm)

Pearl & Necklace Leatherette Folders

- * Leatherette folders with satin interiors and snap closure.
- * 2-pieces packer included.

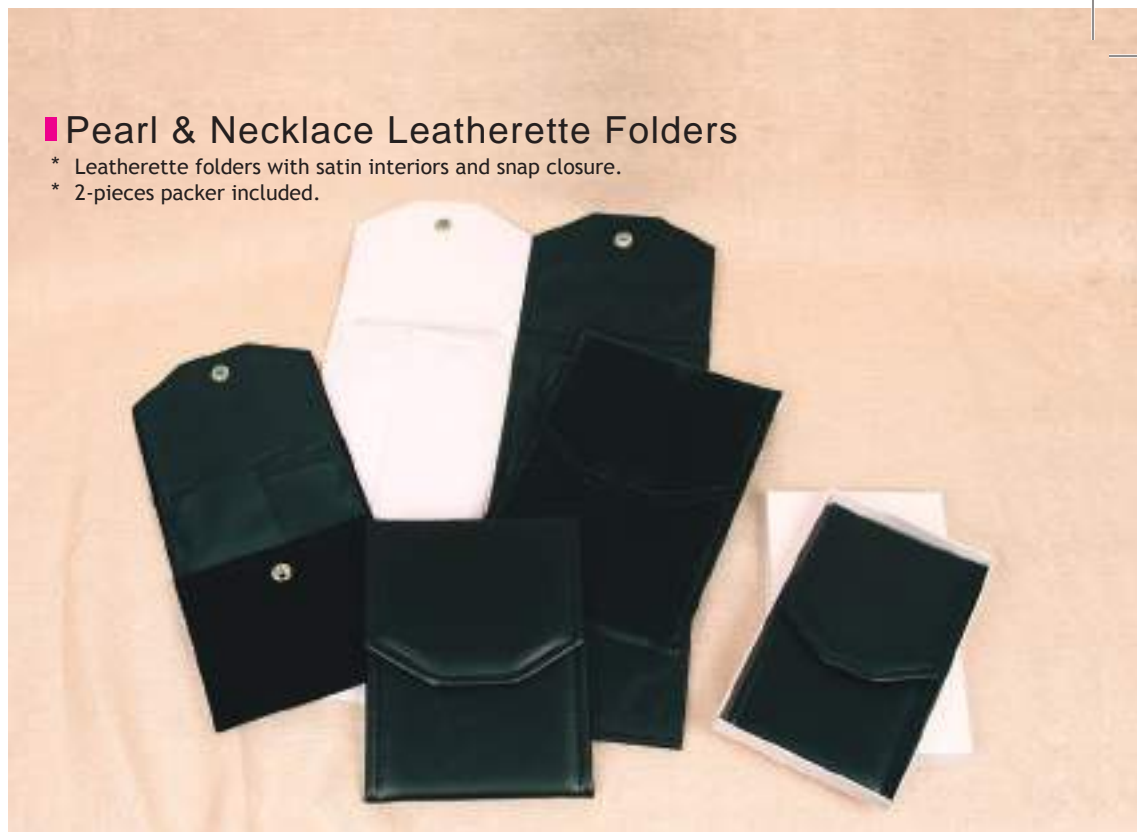

Black Faux Leather w/ White Satin
A. 75 (BK, W)
B. 75-2 (BK, W)
C. 75-3 (BK, W)
D. 75-4 (BK, W)



Black Faux Leather w/ Black Satin
A. 75 (BK)
B. 75-2 (BK)
C. 75-3 (BK)
D. 75-4 (BK)



White Faux Leather w/ White Satin
A. 75 (W, W)
B. 75-2 (W, W)
C. 75-3 (W, W)
D. 75-4 (W, W)



Black Velvet w/ Black Satin
A. 75C (BK)
B. 75C-2 (BK)
C. 75C-3 (BK)
D. 75C-4 (BK)

Bracelet & Watch Presentation Folders

- * Each folder comes with two-piece white packer.
- * Each folder has satin lining and two protective inner flaps.

Closed Size: 2 1/4" W x 9 1/2" H (57 x 240mm)



75-6 (BK, BK)
Black Leatherette w/ Black Satin

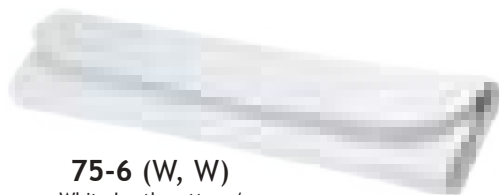

75-6 (W, W)
White Leatherette w/ White Satin

Faux Leather Drawstring Pouches

- * Each color comes in 5 different sizes.



(BK)
Black Faux Leather

(W)
White Faux Leather

Item	Size: W x H	(mm)
A. BG131-1 (Color)	4 1/2" x 7"	(115 x 175)
B. BG131-2 (Color)	3 1/2" x 4 3/4"	(88 x 120)
C. BG131-3 (Color)	3" x 3 1/4"	(75 x 80)
D. BG131-4 (Color)	2 3/8" x 2 1/2"	(60 x 62)
E. BG131-5 (Color)	2" x 2"	(50 x 50)

Assorted Sheer Organza Tote



* The clear plastic that lines the bottom of the bags provides support and helps maintain the shape.

* All sizes packed in 12 assorted colors, each assortment may vary.



BX1514 (MX)

Large Tote

5" x 3" x 7" H
(127 x 76 x 178mm)



BX1513 (MX)

Small Tote

3 1/2" x 2 3/4" x 4 1/2" H
(89 x 70 x 114mm)

Assorted Silky Pouches

* Packed in 6 assortment of colors.



Size	(mm)	Assort Silky
2 1/2" x 2"	(63 x 51)	BX1101T -MX
3" x 2 1/2"	(76 x 63)	BX1102T -MX
3 1/2" x 3"	(89 x 76)	BX1103T -MX
4 1/2" x 3 1/2"	(114 x 89)	BX1104T -MX
5 1/2" x 3 1/2"	(140 x 89)	BX1105T -MX
6 1/2" x 4"	(165 x 102)	BX1106T -MX

Safari Travel Jewelry Rolls

* Feature 3 zippered compartments, a large inside pocket and a ring holding tube that snaps into place.

Open Size: 11" W x 8 1/8" H (279 x 206mm)



BX1109 -LD
Leopard-Print



BX1109 -ZR
Zebra-Print

Silky Travel Jewelry Rolls

* Feature 3 zippered compartments, a large inside pocket and a ring holding tube that snaps into place.

Open Size:
11" W x 8 1/8" H
(279 x 206mm)

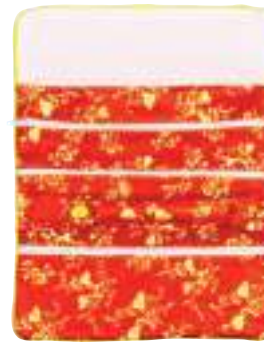

BX1109T -MX
Floral Pattern

Packed in 6
assortment colors

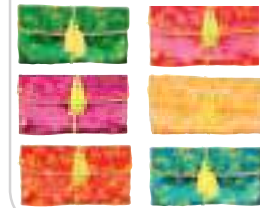

Scalloped-Edge Velvet Pouches

* Each size comes in 3 different colors.

* The teardrop-shaped design allows extra room.

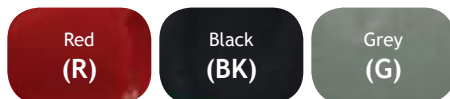

BX1301 (Color)
2" x 2" H
(51 x 51mm)



BX1302 (Color)
2 3/4" x 2 1/2" H
(70 x 63mm)



BX1303 (Color)
3 1/2" x 3" H
(89 x 76mm)

Round Drawstring Pouch

* These luxurious black velvet drawstring pouches, offer stability and more storage space with a round flat bottom. Great for display and packaging. Accented with goldtone cord ends.

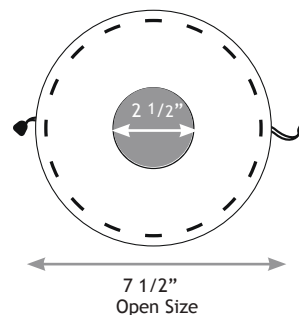

BX1423 (BK)
Base: 2 1/2" Dia.
(63mm)

18-Piece Ring Set

11" W x 11" D x 5" H (280 x 280 x 127mm)



New Ring Slot Style

SET 141-87R

Steel Grey w/Black Faux Leather Trim

6-Ring Set with Color Trims

6" W x 6" D x 3 5/8" H (152 x 152 x 92mm)

* Made of perforated faux black leather. Available in 3 different trims to perfectly accent the set. Holds up to 6 rings.



Set 201 -OR

Black Perforated Faux Leather w/
Orange Trim



Set 201 -SG

Black Perforated Faux Leather w/
Steel Grey Trim



Set 201 -GN

Black Perforated Faux Leather w/
Green Trim

23-Ring Set with Color Trim

12" W x 7 1/4" D x 4 3/8" H (305 x 185 x 112mm)

* Made of perforated faux black leather. Available in 3 different trims to perfectly accent the set. Holds up to 23 rings.



Set 205 -RD

Black Perforated Faux Leather
w/Red Trim



Set 205 -SG

Black Perforated Faux Leather
w/Steel Grey Trim



Set 205 -BL

Black Perforated Faux Leather
w/Blue Trim

Design - Flex Display Set

S-R11L -Color
Ring Insert



2" x 2 1/4" x 7/8"
(51 x 57 x 22mm)

Set 111L -BK
Black Faux Leather



11-Ring Set
13" W x 9 3/4" D x 2 3/4" H
(330 x 248 x 70mm)



Set 111L -WH
White Faux Leather

S-E12L -Color
Earring Tree Insert



2" x 2 1/4" x 2 1/4"
(51 x 57 x 57mm)

Set 112L -WH
White Faux Leather



11-Earring Tree Set
13" W x 9 3/4" D x 4" H
(330 x 248 x 102mm)



Set 112L -BK
Black Faux Leather

S-E13L -Color
Earring Insert



2" x 2 1/4" x 1 1/8"
(51 x 57 x 29mm)

Set 113L -BK
Black Faux Leather



11-Earring Set
13" W x 9 3/4" D x 2 3/4" H
(330 x 248 x 70mm)



Set 113L -WH
White Faux Leather

S-P14L -Color
Pendant/Earring
Insert



2" x 2 1/4" x 7/8"
(51 x 57 x 22mm)

Set 114L -WH
White Faux Leather



11-Pendant Set
13" W x 9 3/4" D x 2 5/8" H
(330 x 248 x 67mm)



Set 114L -BK
Black Faux Leather

S-N15L -Color
Mini Bust Insert



2 1/4" x 2 1/2" x 2 1/4"
(57 x 63 x 57mm)

Set 115L -BK
Black Faux Leather



11-Neckform Set
13" W x 9 3/4" D x 3 3/4" H
(330 x 248 x 95mm)



Set 115L -WH
White Faux Leather

S-W16L -Color
Watch Collar
Insert



2" x 2 1/4" x 1 5/8"
(51 x 57 x 41mm)

Set 116L -WH
White Faux Leather



11-Watch Set
13" W x 9 3/4" D x 3" H
(330 x 248 x 75mm)



Set 116L -BK
Black Faux Leather

6-Ring Set

6" W x 6" D x 3 5/8" H (152 x 152 x 92mm)



Set 101 (BK)
Black Faux Leather



Set 101 (87R)
Steel Grey with Black
Faux Leather Trim



Set 101 (W)
White Faux Leather

23-Ring Slot Set

12" W x 7 1/4" D x 4 3/8" H (305 x 185 x 112mm)



Set 105A (BK)
Black Faux Leather



Set 105A (87R)
Steel Grey with Black
Faux Leather Trim



Set 105A (W)
White Faux Leather

23-Ring Clip Set

12" W x 7 1/4" D x 4 3/8" H (305 x 185 x 112mm)



Set 105 (BK)
Black Faux Leather



Set 105 (87R)
Steel Grey with Black
Faux Leather Trim



Set 105 (W)
White Faux Leather

24-Ring Clip Set

12" W x 7 1/4" D x 3 1/2" H (305 x 185 x 90mm)



Set 106 (BK)
Black Faux Leather



Set 106 (87R)
Steel Grey with Black
Faux Leather Trim



Set 106 (W)
White Faux Leather

■ 16-Ring & 7 Earring/Pendant Set

12" W x 8 1/4" D x 3 1/2" H (305 x 208 x 90mm)



Set 102 (BK)
Black Faux Leather



Set 102 (87R)
Steel Grey with Black
Faux Leather Trim

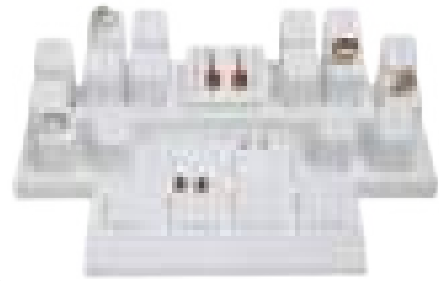

Set 102 (W)
White Faux Leather

■ 24-Ring Clip Set

12" W x 8 1/4" D x 3 1/2" H (305 x 208 x 90mm)



Set 103 (BK)
Black Faux Leather



Set 103 (87R)
Steel Grey with Black
Faux Leather Trim



Set 103 (W)
White Faux Leather

■ 16-Ring & 7 Earring/Pendant Set

12" W x 8 1/4" D x 3 1/2" H (305 x 208 x 90mm)



Set 104 (BK)
Black Faux Leather



Set 104 (87R)
Steel Grey with Black
Faux Leather Trim

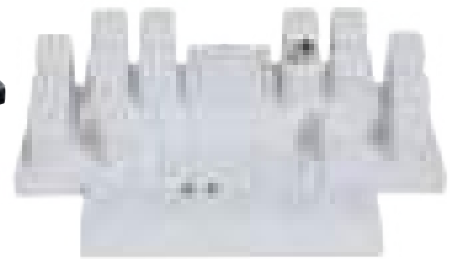

Set 104 (W)
White Faux Leather

■ 6-Ring, 2-Earring, 1-Neckform, 1-Bracelet Ramp

12" W x 8 1/4" D x 7 3/4" H (305 x 211 x 198mm)



Set 107 (BK)
Black Faux Leather



Set 107 (87R)
Steel Grey with Black
Faux Leather Trim



Set 107 (W)
White Faux Leather

9-Piece Mini Furniture Set

Overall Dimension:
16" W x 9 7/8" D x 8 3/8" H
(41 x 25 x 21cm)



Set 132-N3
Burlap w/Natural Wood Trim

6-Ring Set

Overall Dimension:
6" W x 6" D x 3 5/8" H
(15.2 x 15.2 x 9.2cm)



Set 101-N31
Burlap w/Lace

8-Pc. Column Ring Set

Overall Dimension:
11 3/4" W x 3 1/4" D x 4 1/8" H
(29.8 x 8.2 x 10.5cm)



RD-5203-N31
Burlap w/Lace

10-Piece Mini Furniture Set

Overall Dimension:
16 1/2" W x 10 1/4" D x 12" H
(42 x 26 x 30.5cm)



Set 131 -N3
Burlap w/Natural
Wood Trim

Other Available Colors



Set 131 -OR
Orange Faux Suede
w/Natural Wood Trim



Set 131 -GN
Green Faux Suede
w/Natural Wood Trim

12-Piece Set

Overall Dimension: 16 1/8" W x 16 1/8" D x 9 1/8" H
(41 x 41 x 23.2cm)

Cork provides the setting for this remarkably beautiful new jewelry display set. The timeless look is further enhanced by the natural wood trim.



Set 1102-N
Cork w/Natural Wood Trim

12-Piece Set

Overall Dimension: 16" W x 13 1/2" D x 14 1/4" H
(42 x 34 x 37cm)



Set 67-TQ
Turquoise Faux Leather

9-Piece Mini Furniture Set

Overall Dimension: 16 1/2" W x 10 1/4" D x 12" H
(42 x 26 x 30.5cm)



SA3 (RW)
White Faux Leather
w/Glossy
Rosewood Trim

8-Piece Living Room Set

Overall Dimension: 16 1/2" W x 10 1/4" D x 6" H
(42 x 26 x 15cm)



SA1 (RW)
White Faux Leather
w/Glossy
Rosewood Trim

SET 68 Up to 168 Rings, 50-Piece Ring Set

Overall Dimension: 48 1/2" x 17" x 5" H
(123 x 43 x 13cm)

Set 68-L30

Premium Beige w/Steel
Brown Faux Leather Trim

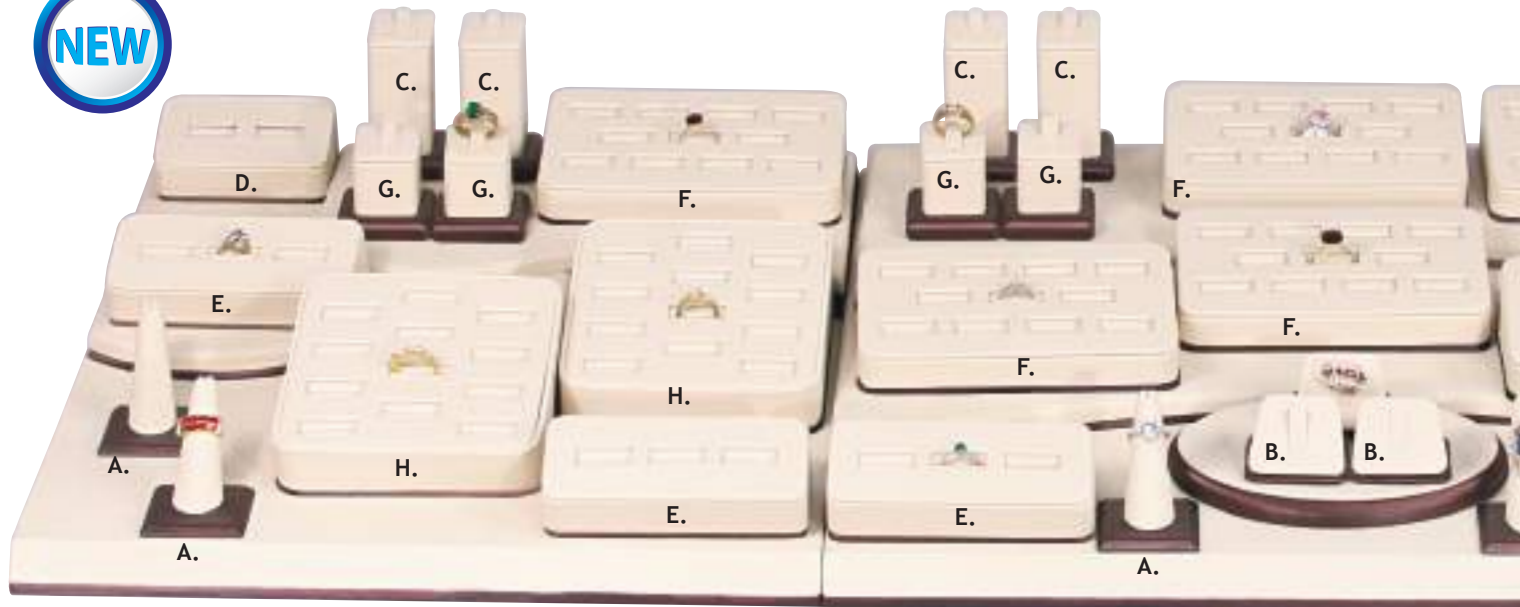

Showcase Collection

56



A.
RD-2444 -L30
Ring Finger
2 1/8" x 2 1/8" x 2 3/8" H
(54 x 54 x 60mm)



B.
RD-0680 -L30
Single Ring Clip
1 7/8" x 1 7/8" x 1 1/4" H
(47 x 47 x 32mm)



C.
RD-0409 -L30
Tall Ring Column
1 3/4" x 1 3/4" x 3" H
(44 x 44 x 76mm)

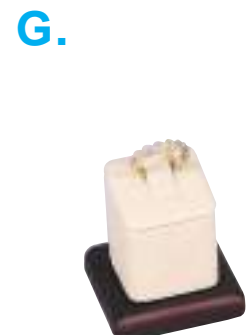

G.
RD-0411 -L30
Short Ring Column
1 3/4" x 1 3/4" x 1 3/4" H
(44 x 44 x 44mm)



D.
RD-0682 -L30
2 Slots Ring Tray
3 1/2" x 2 1/2" x 1 1/8" H
(89 x 63 x 28mm)



E.
RD-0683 -L30
3 Slots Ring Tray
4 3/4" x 2 1/2" x 1 1/8" H
(121 x 63 x 28mm)

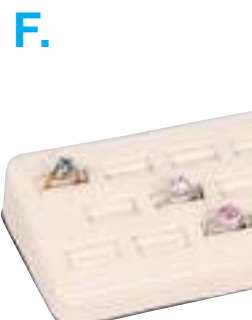

F.
RD-0681 -L30
11 Slots Ring Tray
5" x 5 5/8" x 2 1/4" H
(127 x 143 x 57mm)



H.
BX2470 -L30
12 Slots Ring Tray
5" x 5 3/4" x 2" H
(127 x 146 x 51mm)

Set 68-L30
Premium Beige w/Steel
Brown Faux Leather Trim

This premium plush faux leather comes in a soft beige color that is easy on the eye and soft to the touch.



Also available in Steel Grey Faux Leather



Set 68-87R
Steel Grey Faux Leather w/
Black Faux Leather Trim

Showcase Collection

57

I. * Stage pieces to create your own look to fit your display needs.



* Create your own look by rearranging pieces from the same set.



ST-0680 -L30
10-Pc. Base Set
48 1/2" x 17" x 1 7/8" H
(123 x 43.2 x 4.7cm)

SET 65-L30 24-Piece Set

Overall Dimension: 22 1/2" W x 12 7/8" D x 13 1/4" H (57 x 33 x 34cm)



Premium Beige w/Steel Brown Faux Leather Trim



Showcase Collection



New premium plush faux leather comes in a soft beige color that is easy on the eye and soft to the touch, with the look and feel of exquisitely supple and smooth leather.

SET 67-L30 12-Piece Set

Overall Dimension: 16" W x 13 1/2" D x 14 1/2" H (40.6 x 34 x 37cm)



Premium Beige w/Steel Brown Faux Leather Trim

SET 141-L30 18-Piece Set

Overall Dimension: 11" W x 11" D x 5" H (28 x 28 x 12.7cm)



Premium Beige w/Steel Brown Faux Leather Trim



Mix & Match
Make your own set by rearranging pieces.

SET 64 17-Piece Set

Overall Dimension:
15 3/8" W x 12 1/2" D x 9 1/4" H
(39 x 32 x 24cm)



Set 64 -LE
Beige Linen

Available Colors



White Faux Leather
Set 64 -AW



Black Faux Leather
Set 64 -BK



Steel Grey Faux Leather
Set 64 -87R

SET 65 24-Piece Set

Overall Dimension:
22 1/2" W x 12 7/8" D x 13 1/4" H
(57 x 33 x 34cm)



Set 65 -LE
Beige Linen

Available Colors



White Faux Leather
Set 65 -AW



Black Faux Leather
Set 65 -BK



Steel Grey Faux Leather
Set 65 -87R

SET 62 -AW
28-Piece Set

SET 62 -87R
28-Piece Set



White Faux Leather

Overall Dimension:
22 5/8" W x 13 1/8" D x 16 1/4" H
(52 x 33 x 41cm)

Steel Grey w/Black Faux Leather Trim

Showcase Collection

60

SET 65 -87R 24-Piece Set

Overall Dimension:
22 1/2" W x 12 7/8" D x 13 1/4" H
(57 x 33 x 34cm)



Steel Grey Faux Leather w/Black Faux Leather Trim

Stage pieces to create your own look to fit your display needs.

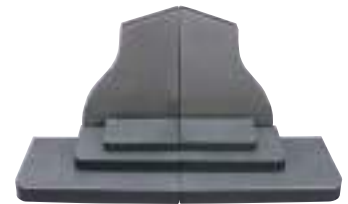

SET 61 (87R) 24-Piece Set

Overall Dimension: 29 1/2" W x 16 3/4" D x 10" H
(75 x 43 x 25cm)



Place all components of Set 61 in base trays for easy and clean storage



Steel Grey with Black Faux Leather Trim

Create different arrangements

Combine two Set 63 to create your own look and an even larger set.



SET 63

18-Piece Set

Overall Dimension: 23" W x 12 3/4" D x 13" H
(58 x 32 x 33cm)



Available Colors



Set 63 -BK
Black Faux Leather



Set 63 -AW
White Faux Leather



Set 63 -87R
Steel Grey w/Black Faux Leather Trim

SET 66 9-Piece Set

Overall Dimension: 13" Dia. x 14 3/4" H
(33 Dia x 37.5cm)

Set 66 -N3
Burlap w/
Natural Wood Trim



Set 66 -RW
White Faux Leather
w/Glossy Rosewood Trim

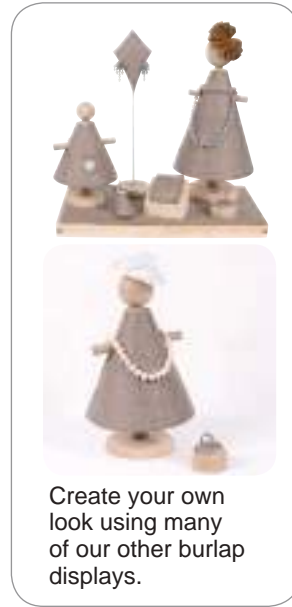

Create your own look using many of our other burlap displays.



Set 66 -87R
Steer Grey Faux Leather
w/Black Wood Trim

SET 66-1-BL 9-Piece Set

Overall Dimension: 13" Dia. x 14 3/4" H
(33 Dia x 37.5cm)



Perforated Black Faux
Leather w/Blue Wood Trim

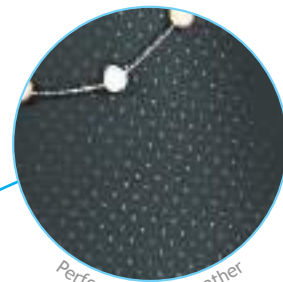

Perforated Faux Leather



Mix & Match
Make your own set by
rearranging pieces.



Overall Dimension: 13" Dia. x 14 3/4" H
(33 Dia. x 37.5cm)

■ SET 56 9-Piece Set



Set 56 (LE)
Linen w/
Wood Trim

Set 56 (87R)
Steel Grey Faux Leather w/
Black Wood Trim



Set 56 (RW)
White Faux Leather w/
Rosewood Trim



Set 56 (RW,BK)
Black Faux Leather w/Rosewood Trim



Set 56 (OR)
Orange Faux Suede w/Black Wood Trim



Set 56 (BD)
Burgundy Faux Suede w/Black Wood Trim



Set 56 (PK)
Pink Faux Suede w/Black Wood Trim



Set 56 (GN)
Green Faux Suede w/Black Wood Trim



Set 56 (PR)
Purple Faux Suede w/Black Wood Trim

Showcase Collection
63

Set 55 (N3)
Burlap w/Natural Wood Trim

SET 55 35-Piece Set

Overall Dimension:
44 1/4" W x 16 1/2" D x 10 3/4" H
(113 x 42 x 27cm)

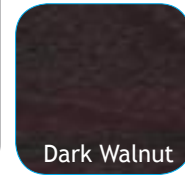
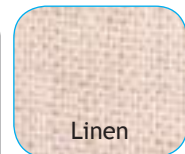
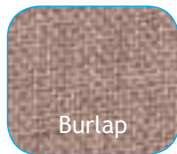

Set 55 (DW,LE)
Linen w/Dark Walnut Trim

NEW



Showcase Collection

64

Flip Set 55 base to use as a storage tray for the disassembled components.

1.



Flip & Stack

2.



Store

3.





Set 55 (87R)
Steel Grey w/Black
Faux Leather Trim



Set 55 (75L)
Chestnut Faux Suede
w/Dark Brown Faux
Leather Trim

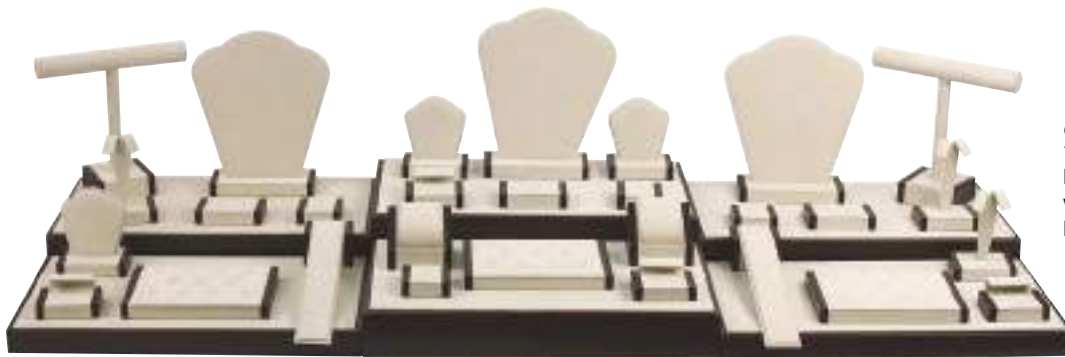

Set 55 (74L)
Beige Faux Suede
w/Dark Brown Faux
Leather Trim



Set 55 (BK,G)
Grey Faux Suede
w/Black Faux
Leather Trim



Set 55 (RW)
White Faux Leather
w/Rosewood Trim

SET 35 26-Piece Set

Overall Dimension:
40 1/4" W x 16" D x 9 3/4" H
(103 x 41 x 25cm)

Set 35 -DW,LE
Linen w/Dark Walnut Trim

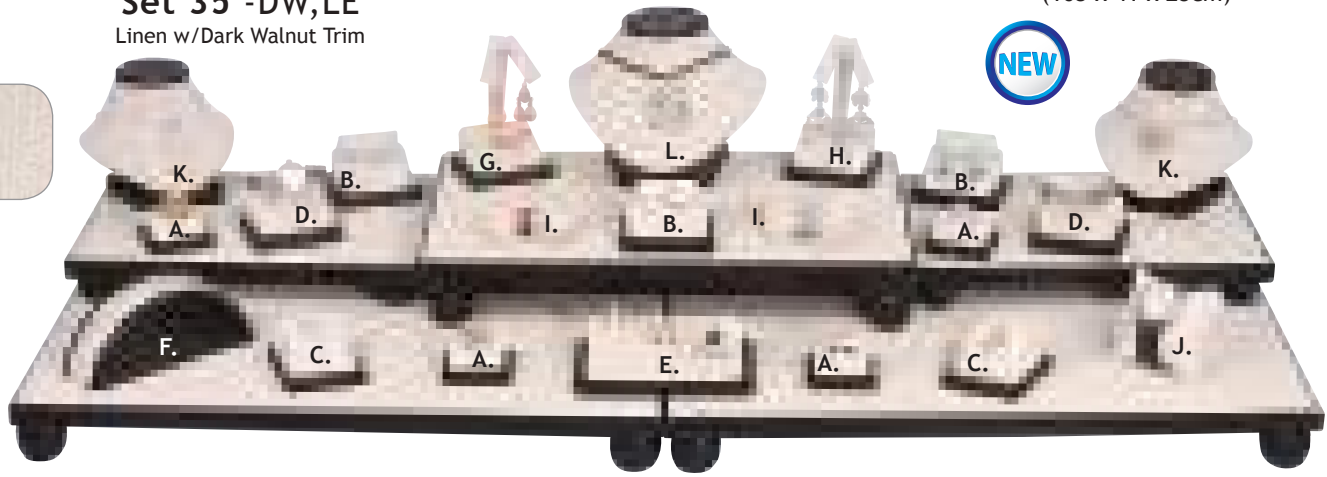

Set 35 -N3
Burlap w/Natural Wood Trim



Showcase Collection

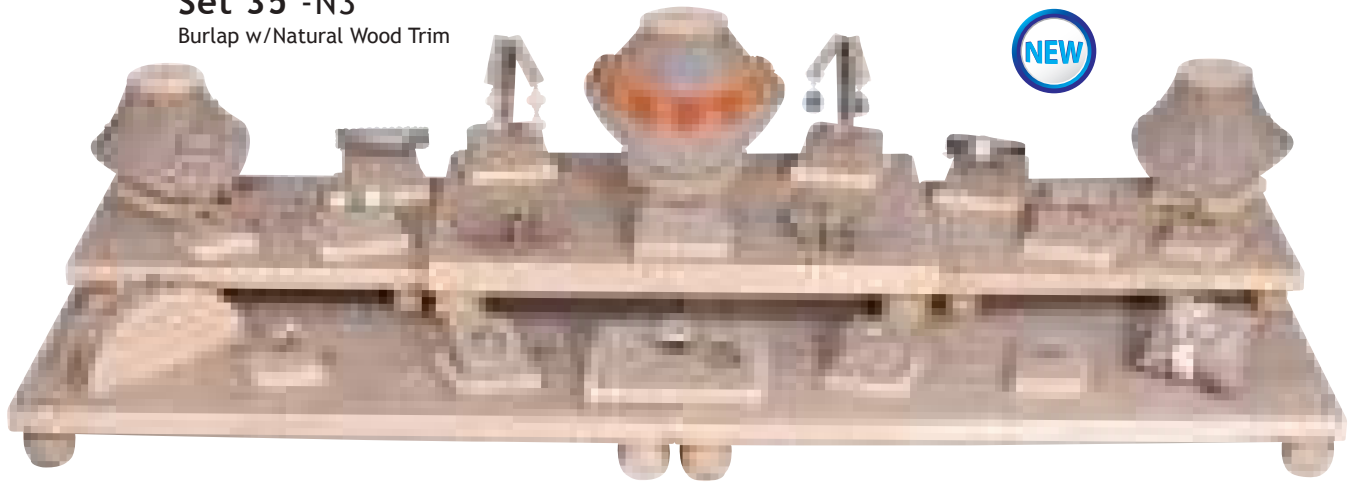

F35-1 (Color)
1-Ring Clip
2 1/8" x 2" x 1" H
(54 x 51 x 25mm)

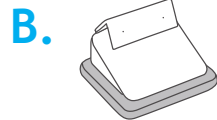

F35-7 (Color)
Earring Flap
3" x 2 1/2" x 1 3/4" H
(76 x 63 x 44mm)



F35-8 (Color)
Pendant
2 1/2" x 3" x 1 1/4" H
(63 x 76 x 32mm)

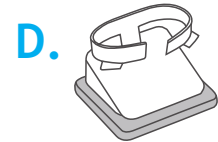

F35-3 (Color)
Watch/Bangle
3" x 2 1/2" x 2" H
(76 x 63 x 51mm)

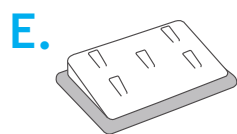

F35-4 (Color)
5-Ring Clip
5 1/2" x 3 3/4" x 1 1/4" H
(140 x 95 x 32mm)



F27-6 (Color)
Bracelet
1 7/8" x 6" x 2 1/2" H
(47 x 152 x 63mm)



F35-21 (Color)
Earring/Ring Combo
3" x 2 1/2" x 4 3/4" H
(76 x 63 x 120mm)



F35-20 (Color)
Earring
3" x 2 1/2" x 4 3/4" H
(76 x 63 x 120mm)



RD-351 -Color
Ring Fan
3" Dia.
(76Dia.)



11-3 (Color)
Pillow
3" x 3" H
(76 x 76mm)

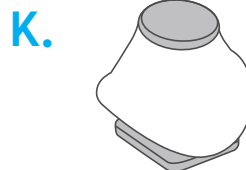

ND-311 -Color
Small Bust
5 1/2" x 3 1/2" x 3 3/4" H
(140 x 89 x 95mm)

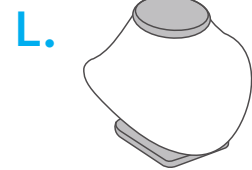

ND-312 -Color
Large Bust
6 3/4" x 4 3/4" x 5 1/8" H
(170 x 122 x 130mm)

Premium Faux
Leather Set



Set 35 -L30
Premium Beige w/Steel Brown Faux Leather Trim

Wood
Trim Set



Set 35 (RW)
White Faux Leather w/Glossy Rosewood Trim

Faux Leather
Trim Set



Set 35 (75L)
Chestnut Suede w/Dark Brown Faux Leather Trim

Faux Leather
Trim Set



Set 35 (87R)
Steel Grey w/Black Faux Leather Trim

Showcase Collection
67

SET 47 (87R)

19-Piece Set

Steel Grey Faux Leather
w/Black Faux Leather Trim

Overall Dimension: 19" W x 11" D x 10 3/4" H
(48 x 28 x 27cm)



SET 46 (87R)

19-Piece Set

Steel Grey Faux Leather
w/Black Faux Leather Trim

Overall Dimension: 23 7/8 - 44 1/2" W x 11" D x 9 1/2" H
(61 - 113 x 28 x 24cm)



SET 46 (75L)

19-Piece Set

Chestnut Suede w/
Dark Brown Faux
Leather Trim

Overall Dimension: 23 7/8 - 44 1/2" W x 11" D x 9 1/2" H
(61 - 113 x 28 x 24cm)



Overall Dimension: 27 3/4 - 33 1/2" W x 15 1/2" D x 13 1/2" H
(70.5 - 85.1 x 39.4 x 34.3cm)



SET 54 (87R)

26-Piece Set

Steel Grey Faux Leather w/
Black Faux Leather Trim



Showcase Collection

Overall Dimension: 37" W x 18" D x 11 5/8" H
(102 x 46 x 29.5cm)

SET 60 (87R)

21-Piece Set

Steel Grey Faux Leather w/
Black Faux Leather Trim



69

SET 42 (RW) 57-Piece Set

White Faux Leather w/Glossy Rosewood Trim

Overall Dimension:
67 1/4" W x 16" D x 7 3/4" H
(171 x 41 x 20cm)



Showcase Collection

70

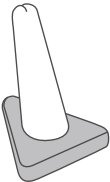
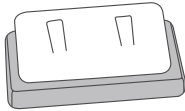
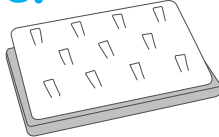
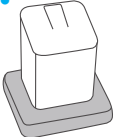
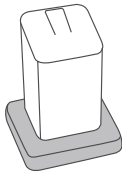
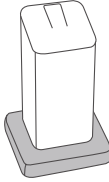
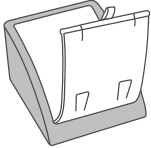
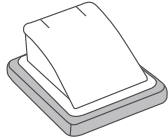
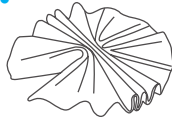
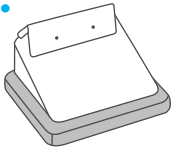
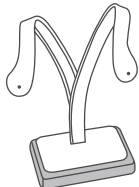
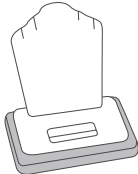
<p>A.  Ring Finger</p> <p>F42-1 (RW) 2" x 2 1/4" x 3" H (51 x 57 x 76mm)</p>	<p>B.  2-Ring Clip</p> <p>F42-2 (RW) 3 1/2" x 2 1/4" x 1" H (89 x 57 x 25mm)</p>	<p>C.  11-Ring Clip</p> <p>F42-6 (RW) 6 1/2" x 4 1/2" x 1" H (165 x 114 x 25mm)</p>
<p>D.  Low Ring Cluster</p> <p>F42-11 (RW) 1 3/4" x 1 3/4" x 1 3/4" H (44 x 44 x 44mm)</p>	<p>E.  Medium Ring Cluster</p> <p>F42-10 (RW) 1 3/4" x 1 3/4" x 2 1/4" H (44 x 44 x 57mm)</p>	<p>F.  Tall Ring Cluster</p> <p>F42-9 (RW) 1 3/4" x 1 3/4" x 3" H (44 x 44 x 76mm)</p>
<p>G.  Combo Opens For Extra Storage</p> <p>F42-5 (RW) 3" x 3 1/2" x 2" H (76 x 89 x 51mm)</p>	<p>H.  Pendant</p> <p>F35-8 (RW) 2 1/2" x 3" x 1 1/4" H (63 x 76 x 32mm)</p>	<p>I.  Ring Fan</p> <p>RD-351L-WH 3" Dia. (76 Dia.)</p>
<p>J.  Earring Flap</p> <p>F35-7 (RW) 3" x 2 1/2" x 1 3/4" H (76 x 63 x 44mm)</p>	<p>K.  Earring Tree</p> <p>F42-4 (RW) 2 1/2" x 1 3/4" x 4" H (63 x 44 x 102mm)</p>	<p>L.  Combo Display</p> <p>F42-3 (RW) 2 3/4" x 2" x 3" H (70 x 51 x 76mm)</p>

SET 42 (RW) 57-Piece Set

White Faux Leather w/Glossy Rosewood Trim



M. Bracelet Ramp
DWB8 -RW
 9" x 1 1/8" x 7/8" H
 (228 x 30 x 23mm)

N. Multi Pair Earring Stand
DWE8 -RW
 6 1/4" x 1 3/4" x 3 1/8" H
 (159 x 44 x 79mm)

O. Multi Pair Earring Stand
DWE3 -RW
 6 1/8" x 1 3/4" x 3" H
 (150 x 44 x 76mm)

P. T-Bar
F42-7 (RW)
 7 1/4" x 2 1/4" x 5 1/2" H
 (184 x 57 x 140mm)

Q. Small Jar Display
JK-652 -RW
 1 5/8" x 3" x 1 5/8" H
 (41 x 76 x 41mm)

R. Large Jar Display
JK-654 -RW
 2 7/8" x 3" x 1 5/8" H
 (73 x 76 x 41mm)

S. Combo Bust
F38-31 (RW)
 4 1/8" x 3 3/8" x 3 1/2" H
 (105 x 86 x 89mm)

T. Bust
ND-312W -RW
 6 3/4" x 4 3/4" x 5 1/8" H
 (170 x 122 x 130mm)

Mix and match to arrange Set 42 in many unique ways.

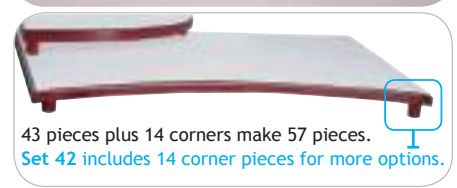

43 pieces plus 14 corners make 57 pieces.
 Set 42 includes 14 corner pieces for more options.

SET 20 (RW)

23-Piece Set

White Faux Leather w/
Glossy Rosewood Trim

Overall Dimension:
40" W x 18" D x 16" H
(102 x 46 x 40cm)



Showcase Collection

72

Ring Clip

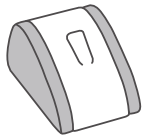

JK-600 -RW
2 1/8" x 3" x 1 5/8" H
(54 x 75 x 40mm)

Multi Ring

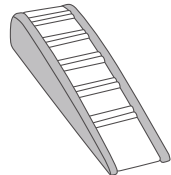

JK-604 -RW
2 1/8" x 8 1/4" x 1 3/4" H
(54 x 210 x 44mm)

Earring Flap

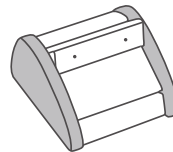

JK-613 -RW
2 7/8" x 3" x 1 5/8" H
(72 x 75 x 40mm)

Earring

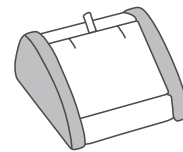

JK-615 -RW
2 7/8" x 3" x 1 5/8" H
(72 x 75 x 40mm)

Earring Tree

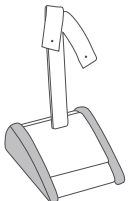

JK-622 -RW
2 1/2" x 3" x 4 1/2" H
(63 x 75 x 115mm)

Ramp

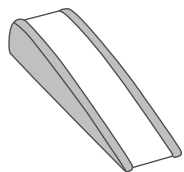

JK-623 -RW
2 1/8" x 8 1/4" x 1 3/4" H
(54 x 210 x 44mm)

T-Bar

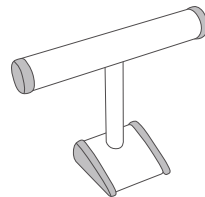

JK-624 -RW
7 1/2" x 3" x 6" H
(190 x 75 x 152mm)

Large Bust

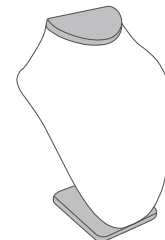

JK-628 -RW
7 3/8" x 5 1/2" x 8 3/4" H
(186 x 140 x 220mm)

Multi Ring

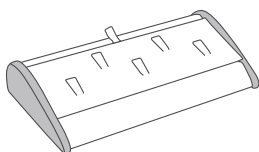

JK-606 -RW
8 1/2" x 4 3/8" x 1 5/8" H
(217 x 110 x 40mm)

Multi Necklace

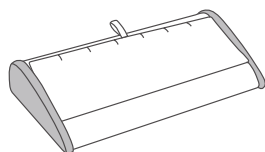

JK-607 -RW
8 1/2" x 4 3/8" x 1 5/8" H
(217 x 110 x 40mm)

Multi Bracelet

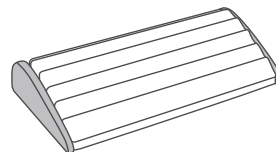

JK-609 -RW
9 1/2" x 4 3/8" x 1 5/8" H
(235 x 110 x 40mm)

Elaborate Set 20 with
this 6-Ring Slot Display

Sold Separately



JK-657 -RW
8 3/4" x 4 1/2" x 1 3/4" H
(222 x 114 x 44mm)

Overall Dimension: 36 1/2" W x 13 3/4" D x 11 1/2" H
(93 x 35 x 29cm)

SET 45 (RW) 33-Piece Set

White Faux Leather
w/Glossy Rosewood Trim



Overall Dimension: 26" W x 14 1/2" D x 13" H
(66 x 37 x 33cm)

SET 53 (RW) 22-Piece Set

White Faux Leather
w/Glossy Rosewood Trim



Rosewood Stand Displays

DWB4 -RW

DWH7 -RW

DWE6 -RW

DWE2 -RW

DWR2 -RW

DWE4 -RW

DWP3 -RW

DWE3 -RW

DWP5 -RW

* Made of beautiful white faux leather with a rosewood trim base. These individual displays can be arranged in many distinct ways to fit your specific display needs.



Item	Description	Size: Wx H	(mm)
DWE2 -RW	Earring	2" x 2 1/2"	(51 x 65)
DWR2 -RW	2-Clip Ring	2" x 2 1/2"	(51 x 65)
DWP3 -RW	Earring	2" x 2 1/2"	(51 x 65)
DWP5 -RW	Large Pendant	3 1/4" x 3 3/4"	(84 x 95)
DWE3 -RW	5-Pr. Earring	6 1/8" x 3"	(156 x 76)
DWE4 -RW	5-Pr. Earring	6 1/8" x 4"	(156 x 100)
DWE6 -RW	13-Pr. Earring	4 7/8" x 7 1/2"	(124 x 191)
DWB4 -RW	10-Chain Stand	7 1/4" x 9 1/2"	(184 x 242)
DWH7 -RW	24-Hook Stand	7 1/4" x 9 1/2"	(184 x 242)

SET 34 22-Piece Set Overall Dimension: 36" W x 19" D x 7 3/4" H (91 x 48 x 20cm)



4 Colors to choose from



Set 34 (SG)
Steel Grey Faux Leather



Set 34 (BK)
Black Faux Leather



Set 34 (LE)
Beige Linen



Set 34 (AW)
White Faux Leather

Showcase Collection

74



Easy Storage Great for Trade Show



1 Display



2 Store



3 Carry Away
in 91-S34

Set includes
carrying case

3-Pc Base Set with Snap-close Compartments for Storage

F34-B1 (Color)

3-Pc. Base Set
18 1/2" x 14" x 3 7/8" H
(470 x 355 x 98mm)



* Each of the 3-piece bases
contains a storage area to hold
all 14 display components.

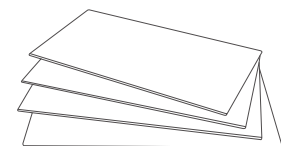

F34-B2 (Color)

4-Pc. Base Board Set
9 1/2" x 18" (240 x 460mm)

Overall Dimension: 68" W x 18 1/4" D x 2 1/2" H (173 x 46 x 6.4cm)

SET 22 (87R)
18-Piece Set

Steel Grey Faux Leather
w/Black Faux Leather Trim



White Faux Leather

SET 22 (W)
18-Piece Set



SET 22-1 (87R)
8-Piece Set

Overall Dimension:
29" W x 18 1/4" D x 2 1/2" H
(74 x 46 x 6.4cm)



Steel Grey Faux Leather
w/Black Faux Leather Trim

SET 22-1 (W)
8-Piece Set



White Faux Leather

Overall Dimension: 69" W x 14" D x 14" H
(175 x 36 x 36cm)

SET 11 (W)
20-Piece Set

Plain White Faux Leather

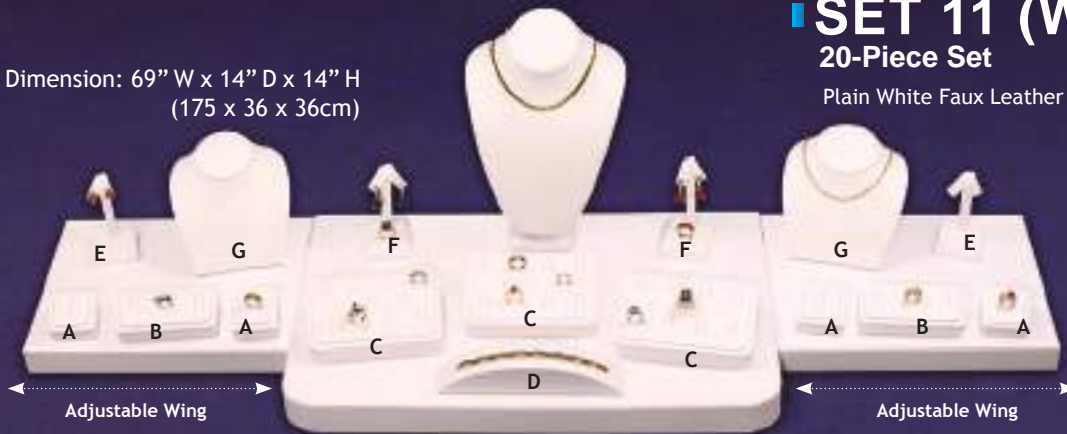

Item	Description	Size: W x D x H	(mm)
A. GR-44 (W)	1-Ring Clip	2 1/8" x 2 1/4" x 1 5/8" H	(55 x 57 x 41)
B. GR-42 (W)	3-Ring Clip	4 3/4" x 2 1/8" x 1 3/4" H	(120 x 54 x 43)
C. GR-40 (W)	11-Ring Clip	6 1/4" x 4 3/8" x 1 3/4" H	(158 x 110 x 43)
D. F4-1 (W,W)	Bracelet Ramp	8 1/8" x 1 5/8" x 1 3/8" H	(205 x 40 x 35)
E. F7-21 (W)	Earring Tree	2 1/4" x 2 1/4" x 4 1/4" H	(57 x 57 x 108)
F. F7-20 (W)	Earring/Ring Tree	2 1/4" x 2 7/8" x 4 1/4" H	(57 x 73 x 108)
G. 189-5L (W)	Low Bust	6" x 5" x 5" H	(152 x 127 x 127)
H. 189-2L (W)	Tall Bust	7 1/2" x 5 1/8" x 11" H	(191 x 130 x 280)
I. ST-2004	White Faux Leather base Set	48" - 69" W x 14" D x 2" H	(125 - 175 x 35 x 5cm)

SET 17 (87R)

19-Piece Set

Steel Grey Faux Leather
w/Black Faux Leather Trim



Overall Dimension:
24" W x 16" D x 11" H
(60 x 41 x 28cm)

SET 17 (W)

19-Piece Set

All White Faux Leather



Overall Dimension:
24" W x 16" D x 11" H
(60 x 41 x 28cm)

	Steel Grey Faux Leather	All White Faux Leather	Description	Size: W x D x H	(mm)
A.	11-3R (SG)	11-3L (W)	Pillow x 1	3" x 3"	(76 x 76)
B.	BD1701 -87R	BD1701L -WH	Narrow Bracelet x 1	2 3/8" x 1 1/2" x 8 1/4"	(60 x 38 x 210)
C.	BD1702 -87R	BD1702L -WH	Wide Bracelet x 1	2 3/8" x 1 1/2" x 8 1/4"	(60 x 38 x 210)
D.	BD1703 -87R	BD1703L -WH	Bangle Bar x 1	8" x 4 1/4" x 3 3/4"	(205 x 108 x 95)
E.	ED1704 -87R	ED1704L -WH	Earring Tree x 3	2 3/8" x 1 1/2" x 4 1/4"	(60 x 38 x 108)
F.	F17-B (87R)	F17-B (WH)	3-Pc. Base x 1	23 1/2" x 16" x 4 3/4"	(598 x 407 x 120)
G.	ND1704 -87R	ND1704L -WH	Brooch/Pin x 1	3" x 2" x 2 3/4"	(75 x 50 x 70)
H.	ND1705 -87R	ND1705L -WH	Low Neckform x 1	4 3/4" x 5" x 2 3/4"	(120 x 127 x 70)
I.	ND1706 -87R	ND1706L -WH	Bust Stand x 1	7 1/4" x 7" x 6 1/2"	(184 x 178 x 165)
J.	PD1703 -87R	PD1703L -WH	Pendant x 1	3" x 2" x 2 3/4"	(75 x 50 x 70)
K.	RD1713R -SG	RD1713L -WH	Short Ring x 1	1 3/4" Dia. x 3/4"	(44 Dia. x 20)
L.	RD1714 -87R	RD1714L -WH	Medium Ring x 2	1 7/8" Dia. x 2"	(48 Dia. x 50)
M.	RD1715 -87R	RD1715L -WH	Tall Ring x 2	1 7/8" Dia. x 2 3/4"	(48 Dia. x 70)

Overall Dimension:
30 1/4" W x 22" D x 15 1/4" H
(77 x 56 x 38.7cm)



SET 19 (87R)

17-Piece Set

Steel Grey Faux Leather
w/Black Faux Leather Trim

Overall Dimension:
30 1/4" W x 22" D x 15 1/4" H
(77 x 56 x 38.7cm)



SET 19 (AW)

17-Piece Set

White Faux Leather

	Steel Grey Faux Leather	All White Faux leather	Description	Size: W x D x H	(mm)
A.	189-2L (87R)	189-2L (W)	Large Bust x 1	7 1/2" x 5 1/8" x 11"	(191 x 130 x 280)
B.	189-3L (87R)	189-3L (W)	Small Bust x 1	5" x 4 1/8" x 7 1/2"	(126 x 104 x 190)
C.	234-A (BK)	234-A (W)	Hand Display x 1	4" x 8 1/4"	(102 x 210)
D.	BD1703 -87R	BD1703L -WH	Bangle Bar x 1	8" x 4 1/4" x 3 3/4"	(205 x 108 x 95)
E.	F4-1 (87R)	F4-1 (W, W)	Bracelet x 1	8 1/8" x 1 5/8" x 1 3/8"	(205 x 40 x 35)
F.	F4-18 (87R)	F4-18 (W, W)	Flap Earring x 1	2 3/8" x 2" x 1 1/2"	(60 x 50 x 38)
G.	F7-21 (87R)	F7-21 (W)	Earring x 2	2 1/4" x 2 1/4" x 4 1/4"	(57 x 57 x 108)
H.	GR-41 (87R)	GR-41 (W)	Ring x 1	5 1/4" x 3 3/4" x 1 3/4"	(134 x 96 x 43)
I.	GR-42 (87R)	GR-42 (W)	Ring x 1	4 3/4" x 2 1/8" x 1 3/4"	(122 x 54 x 43)
J.	GR-44 (87R)	GR-44 (W)	Ring x 4	2 1/8" x 2 1/4" x 1 5/8"	(55 x 57 x 41)
K.	ST-2005 (87R)	ST-2005 (W)	Base x 1	30 1/4" x 12" x 4 1/8"	(770 x 302 x 102)

SET 9 (AW)

28-Piece Set

White Faux Leather

Overall Dimension: 40" W x 18" D x 11" H
(101 x 46 x 28cm)



SET 9 (74L)

28-Piece Set

Beige Faux Suede w/Dark
Brown Faux Leather Trim



Showcase Collection

78

SET 9 (75L)

28-Piece Set

Chestnut Faux Suede w/Dark
Brown Faux Leather Trim



A. F7-2 (Color)

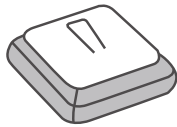

1-Ring Clip
2 1/4" x 2 1/4" x 3/4" H
(56 x 56 x 20mm)

B. F7-3 (Color)

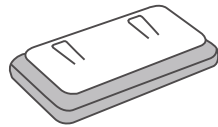

2-Ring Clip
3 1/2" x 2 1/4" x 3/4" H
(90 x 56 x 20mm)

C. F7-4 (Color)

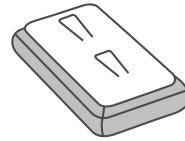

2-Ring Clip
2 1/4" x 3 1/2" x 3/4" H
(56 x 90 x 20mm)

D. F7-5 (Color)

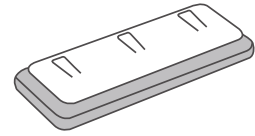

3-Ring Clip
5 3/4" x 2 1/4" x 3/4" H
(145 x 56 x 20mm)

E. F7-6 (Color)

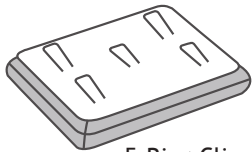

5-Ring Clip
4 5/8" x 3 3/8" x 1" H
(117 x 85 x 25mm)

F. F4-9 (Color)

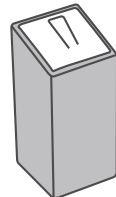

Tall Ring Cluster

1 1/2" x 1 1/2" x 3 3/8" H
(38 x 38 x 88mm)

G. F4-10 (Color)

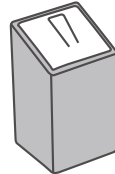

Medium Ring Cluster

1 1/2" x 1 1/2" x 2 7/8" H
(38 x 38 x 73mm)

H. F4-11 (Color)

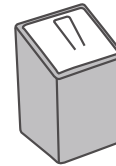

Low Ring Cluster

1 1/2" x 1 1/2" x 2 1/2" H
(38 x 38 x 63mm)

I. F7-19 (Color)

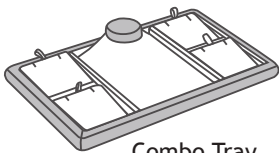

Combo Tray
8 7/8" x 5 1/4" x 1 3/4" H
(225 x 132 x 45mm)

J. F7-7 (Color)

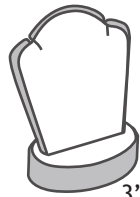

Necklace

3" x 2" x 4" H
(78 x 49 x 104mm)

K. F7-8 (Color)



Necklace

2 3/4" x 1 7/8" x 3 1/2" H
(70 x 48 x 90mm)

L. F7-17 (Color)

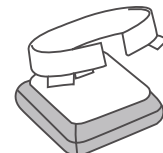

Horizontal Watch Collar

2 1/4" x 2 1/4" x 2 1/4" H
(57 x 57 x 57mm)

M. F9-7 (Color)

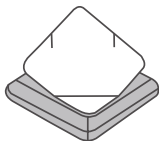

Pendant

2 1/4" x 2 1/4" x 1" H
(55 x 55 x 25mm)

N. F7-16 (Color)

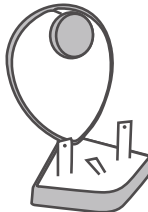

Combo Set

4 1/8" x 3 3/8" x 5 1/4" H
(105 x 85 x 135mm)

O. F9-4 (Color)



Combo Set

5 1/4" x 4 1/2" x 4 3/4" H
(134 x 115 x 120mm)

P. F9-5 (Color)



Vertical Watch Collar

2 1/4" x 2 1/4" x 3 1/2" H
(55 x 55 x 90mm)

Q. F4-18 (Color)

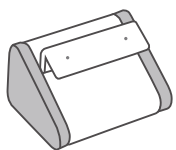

Flap Earring

2 3/8" x 2" x 1 1/2" H
(60 x 50 x 38mm)

R. F4-12 (Color)



Low Neckform

4 1/2" x 5 1/2" x 3" H
(115 x 140 x 75mm)

S. F4-15 (Color)

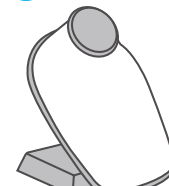

Small Bust

4 3/4" x 6" x 5 3/4" H
(121 x 151 x 145mm)

T. F4-14 (Color)

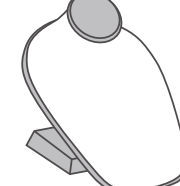

Large Bust

6" x 8" x 7 1/8" H
(152 x 203 x 181mm)

U. F4-1 (Color)

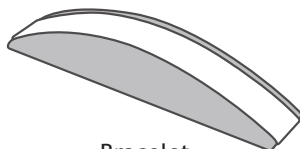

Bracelet

8 1/8" x 1 5/8" x 1 3/8" H
(205 x 40 x 35mm)

V.

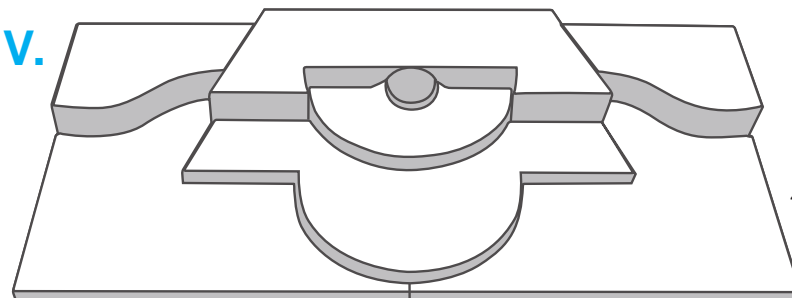

F7-B (Color)

Platform Set

40" x 18" x 3 3/4" H
(1015 x 485 x 95mm)

3-Pc. Curved Base Set



ST-2005 (W)

Plain White Faux Leather
30 1/4" x 12" x 4 1/8" H
(77 x 30 x 10cm)

ST-2005 (87R)

Steel Grey Faux Leather w/ Black Trim
30 1/4" x 12" x 4 1/8" H
(77 x 30 x 10cm)

Side Wing:
15 1/8" x 12" x 4 1/8" H
(38 x 30 x 10cm)

Center Piece:
16" x 11 3/4" x 3" H
(40.5 x 30 x 8cm)

2-Pc. Corner Base Set

ST-1002 (W)

White Faux Leather
7 1/2" W x 19" D x 1" H
(191 x 483 x 25mm)

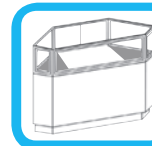

ST-1002 (W) fits perfectly in most corner display cases.

3-Pc. Adjustable Set

Overall Dimension:
48" - 69" W x 14" D x 2" H
(125 - 175 x 35 x 5cm)



ST-2004N-N3

Burlap

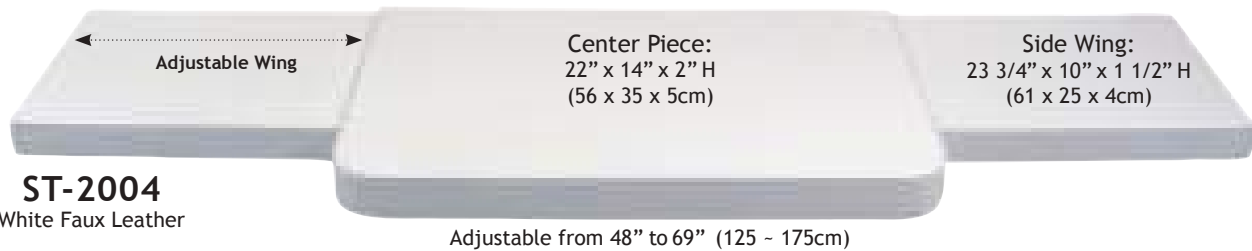

ST-2004

White Faux Leather

Adjustable from 48" to 69" (125 - 175cm)

5-Pc. Base Set

40 1/4" x 16" x 4 1/2" H (102 x 41 x 11.5cm)
Arrange stage pieces to create your own look to fit your display needs.



F35-B (DW,LE)

Linen w/Dark Walnut Trim



F35-B (87R)

Steel Grey Faux Leather w/Black Faux Leather Trim



F35-B (N3)

Burlap w/Natural Wood Trim

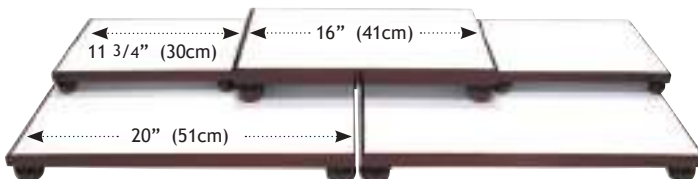

F35-B (RW)

White Faux Leather w/Glossy Rosewood Trim



F35-B (75L)

Chestnut Faux Suede w/Dark Brown Faux Leather Trim

Zebra Collections

* Available in Pink Velvet w/Zebra Trim and Black Velvet w/Zebra Trim



ND-2886V-Color
5 5/8" x 4 1/2" x 8 1/4"
(143 x 114 x 210mm)

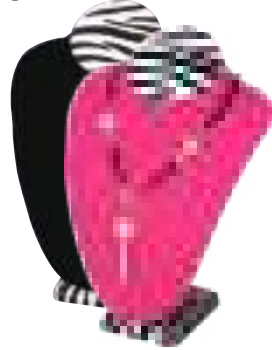

ND-1892V-Color
7 1/2" x 5 1/8" x 11"
(192 x 130 x 280mm)

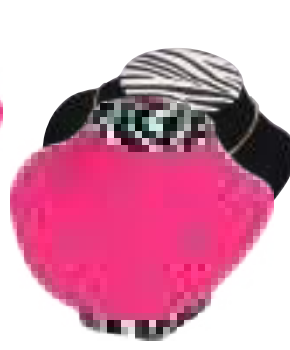

ND201V-Color
8 1/2" x 7 1/4" x 6 1/2"
(216 x 185 x 165mm)

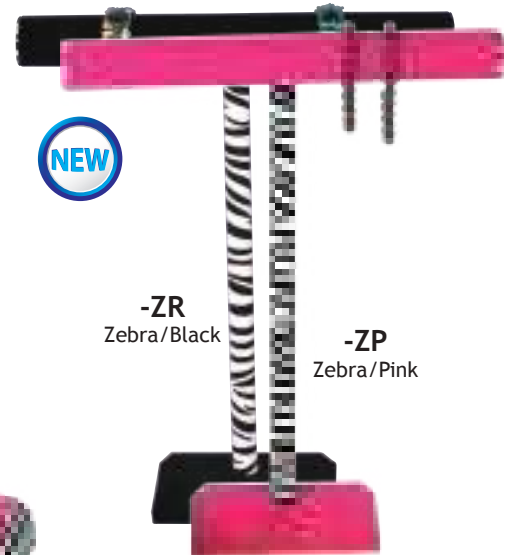

NEW

-ZR
Zebra/Black

-ZP
Zebra/Pink

BD-2114V-Color
14" x 18 1/8"
(355 x 460mm)



F42-6 (Color)
6 1/2" x 4 1/2" x 1"
(165 x 114 x 25mm)



BX2470V-Color
5" x 5 3/4" x 2"
(127 x 146 x 50mm)



BD-2300V-Color
8 1/4" x 5" x 2 1/2"
(210 x 127 x 63mm)



BD-2111V-Color
7 1/2" x 5"
(190 x 127mm)



244-4V (Color)
2 1/8" x 2 1/8" x 2 3/8"
(54 x 54 x 60mm)



ED-724V-Color
2 1/4" x 2 1/4" x 4 1/4"
(57 x 57 x 108mm)



RD104V-Color
1 3/8" x 1 3/8" x 1 5/8" - 3"
(35 x 35 x 41 - 76mm)

Burlap Lace Collections



BX2470-N31
5" x 5 3/4" x 2"
(127 x 146 x 50mm)



SET101-N31
6" x 6" x 3 5/8"
(152 x 152 x 92mm)



ND-2886-N31
5 5/8" x 4 1/2" x 8 1/4"
(143 x 114 x 210mm)

NEW



ND-1892-N31
7 1/2" x 5 1/8" x 11"
(192 x 130 x 280mm)



210-N31
7 3/4" x 4 1/4" x 1 1/2"
(197 x 108 x 38mm)



BD-2221-N31
7 3/8" x 6 3/8"
(187 x 162mm)



BD-2111-N31
7 1/2" x 5"
(190 x 127mm)



CD-6733-N31
6 1/2" x 7 7/8"
(165 x 200mm)



MR-1803-N31
7 1/4" x 10"
(184 x 254mm)



BD-2300-N31
8 1/4" x 5" x 2 1/2"
(210 x 127 x 63mm)



RD-5203-N31
11 3/4" x 3 1/4" x 4 1/8"
(298 x 82 x 105mm)



ST-3138N-N3

Burlap

6-Pc Set

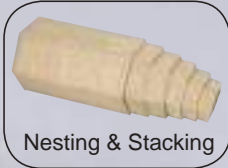

Nesting & Stacking

6-Pc. Nested Riser Stackable Set

2 - 4"Diag (50 - 102mm) x 1 1/4" - 6 1/4" H (25-152mm)



ST-3138N-LE

Beige Linen



ST-3138R-SG

Steel Grey Faux Leather



ST-3138L-WH

White Faux Leather

3-Pc. Cylinder Set

3 1/8" Dia. (80mm Dia.)



2 1/2" H (64mm)



1 3/4" H (44mm)



1" H (25mm)

501L-1 (W)
501L-1 (BK)
501F-1 (BK)

3-Pc. Hexagon Set

4 1/8" Diag. (104mm Diag.)



2 1/2" H (64mm)

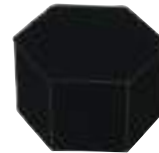

1 3/4" H (44mm)



1" H (25mm)

503L-1 (W)
503L-1 (BK)
503F-1 (BK)

3-Pc. Square Set

3 1/8" Sq. (80 Sq. mm)



2 1/2" H (64mm)



1 3/4" H (44mm)

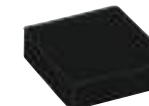

1" H (25mm)

502L-1 (W)
502L-1 (BK)
502F-1 (BK)

Available Colors



White Faux Leather
L-1(W)



Black Faux Leather
L-1(BK)



Black Velvet
F-1(BK)

6-Pc. Wood Top Set



513W (RW)
Faux White Leather
w/Rosewood Top

4" Diag. (102mm Dia.)

1 1/4" - 6 1/4" H (32 - 160mm)

6-Pc. Hexagon Set



513L (W)
513L (BK)
513 (BK)

4" Diag. (102mm Dia.)

1 1/4" - 6 1/4" H (32 - 160mm)

6-Pc. Large Hexagon Set



513L-1 (W)
513L-1 (BK)
513-1 (BK)

6 1/8" Diag. (155mm Diag.)

1 1/4" - 6 1/4" H (32 - 160mm)

6-Pc. Square Set



512L (W)
512L (BK)
512 (BK)

3 1/8" Sq. (80mm)

1 1/4" - 6 1/4" H (32 - 160mm)

6-Pc. Cylinder Set



511L (W)
511L (BK)
511 (BK)

3" Dia. (76mm Dia.)

1 1/4" - 6 1/4" H (32 - 160mm)

3-Pc. Mini Table Top Set



516L (W)
516L (BK)
516 (BK)

8" x 4" x 3" H
(204 x 102 x 76mm)

6 3/4" x 4" x 2 1/2" H
(171 x 102 x 63mm)

5 1/2" x 4" x 2" H
(140 x 101 x 51mm)

Stackable Mini Displays
3 3/4" x 2 1/2" x 2 1/8" H (95 x 63 x 54mm)



Available Colors

N-LE
Linen

N-N3
Burlap

(W)
White
Faux
Leather



XD-2815N-LE
XD-2815N-N3
F8-15 (W)

Ring/Earring/Pendant



XD-2816N-LE
XD-2816N-N3
F8-16 (W)

Pendant/Earring



XD-2817N-LE
XD-2817N-N3
F8-17 (W)

Ring (5-Slot)



XD-2818N-LE
XD-2818N-N3
F8-18 (W)

Ring/Earring



XD-2819N-LE
XD-2819N-N3
F8-0 (W)

Ring/Earring/Pendant



Mini Displays

1 7/8" x 1 7/8" x 1" H
(47 x 47 x 25mm)

Available Colors



Mini Display/Insert

2 3/8" x 2" x 1 3/8" H
(60 x 50 x 35mm)



Mini Stands

2" x 1 3/4" x 7/8" H (50 x 44 x 22mm)



ER-1004 (Color)
Pendant/Earring

ER-1005 (Color)
Pendant/Earring/Hook

ER-1006 (Color)
Combo/Ring (Clip)

Mini Display/Insert

2" x 1 5/8" x 1 1/4" H (50 x 41 x 32mm)



* Each pad can stand alone as a display or use with tray liners, #99-12 and #99-18.



* Each pad can stand alone as a display or use with tray liners, #96-24.

Versatile Showcase Trays

Create Your Own Look with These White Faux Leather Trays



- * Ideal for typical 4", 5" & 6" (122, 152, 183cm) showcase arrangement.
- * Features interchangeable trays to present variety of merchandise.
- * Angled tray base enhances viewing of merchandise.

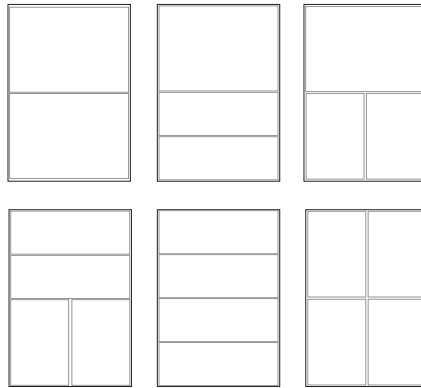

Standard Size Tray w/18 Pads



F8-26 (W)
18-Pendant/Earring Pad
14 5/8" x 8 1/4" x 1" H
(37.1 x 21 x 2.5cm)

Angled Tray Bases



F8-7 (W)
Base
11 5/8" x 16 1/8" x 4" H
(29.5 x 40.5 x 10cm)

Large Insert Trays



F8-6 (W)
Open Plain Tray
F8-5 (W)
14-Chain Tray
10 7/8" x 15 5/8" x 1 7/8" H
(28 x 40 x 5cm)

Medium Insert Trays

10 1/4" x 7 1/2" x 1" H (26 x 19 x 2.5cm)

F8-21 (W) Ring Tray (46-Slot)



F8-24 (W) Bracelet Tray (12)



F8-23 (W) Pendant Tray (16)

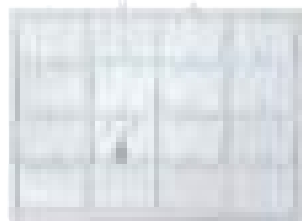

Use replacement pad **F8-P3**

F8-22 (W) Earring Tray (24-Pr.)

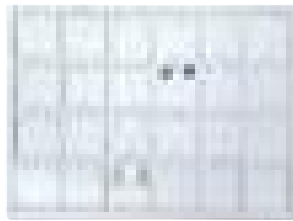

Use replacement pad **F8-P2**

F8-P3 (W)

F8-P2 (W)

Narrow Insert Trays

10 1/4" x 3 3/4" x 1" H (26 x 9.6 x 2.5cm)

F8-11 (W) Ring Tray (26-Slot)

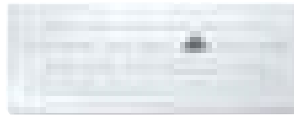

F8-12 (W) Earring Tray (12-Pr.)



● Use replacement pad item **F8-P2**

F8-13 (W) Pendant Tray (8)



F8-14 (W) Bracelet Tray (6)



● Use replacement pad item **F8-P3**

Small Insert Trays

5" x 7 1/2" x 1" H (13 x 19 x 2.5cm)

F8-1 (W)
Ring Tray (25-Slot)



F8-2 (W)
Earring Tray (12 Pr.)



● Use replacement pad **F8-P2**

F8-3 (W)
Pendant Tray (8)



● Use replacement pad **F8-P3**

Multi-Function Stackable Trays

* Use the interchangeable components to create a display that can adapt to your needs.

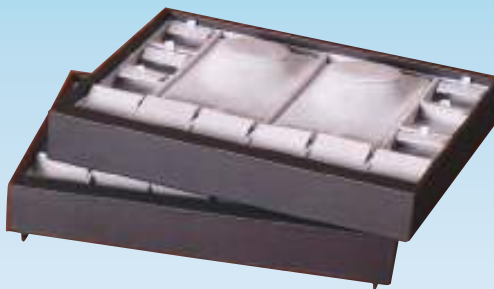

Each Tray Size: 12 1/8" W x 10" D x 2" H
(309 x 254 x 50mm)

Soft Duffle Bag



Our deluxe soft carrying duffle bags 91-G & 91-H each can hold 5 of these trays. Bags sold separately.

Each tray comes with 28 pc components:

2-Necklace 6-Earring 12-Ring
1-Bracelet 6-Pendant 1-Tray

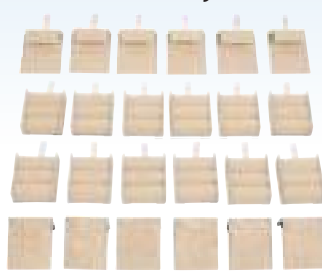

Available Colors

TY-1109 -74L
Beige Suede w/
Dark Brown Faux Leather Tray

TY-1109 -BK, G
Grey Suede w/
Black Faux Leather Tray

TY-1109 -78R
Black Faux Leather w/
Steel Gray Faux Leather Tray



Presentation Folders



Open: 12" x 9 7/8" (305 x 250mm)
Closed: 5 3/4" x 9 7/8" (145 x 250mm)

95-C (74L)

Beige Suede w/
Dark Brown Faux Leather Cover

Available Colors



95-C (GD)
White Faux Leather w/
Gold Rope Trim



95-C (W)
All White Faux Leather



95-C (BK, W)
White Faux Leather w/
Black Velvet Cover



95-C (BK)
All Black Velvet

Stackable Ring Trays w/14 Clips

8 7/8" x 4 3/4" x 1 3/4" H (225 x 121 x 44mm)



S-1 (W)

White Faux Leather



S-1 (BK)

Black Suede Trim

Presentation Trays

10 1/2" W x 8 5/8" D x 1" H (267 x 219 x 25mm)



T-16 (74L)

Beige Faux Suede w/
Dark Brown Faux Leather Tray



T-16L (BK)

All Black Faux Leather



T-16L (W)

All White Faux Leather



T-16 (78R)

Black Faux Leather
with Steel Grey Trim

Burlap Ring Displays



195N-N3

8 1/8" x 1 3/4" x 1" H
(206 x 44 x 25mm)

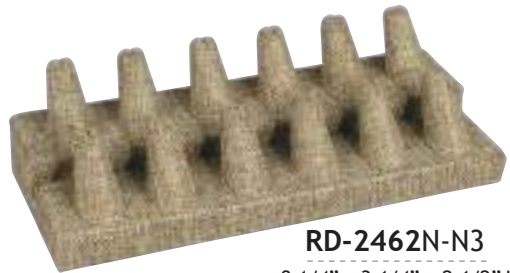

RD-2462N-N3

8 1/4" x 3 1/4" x 2 1/2" H
(210 x 82 x 63mm)



RD-2444N-N3

2 1/8" x 2 1/8" x 2 3/8" H
(54 x 54 x 60mm)



RD-2441N-N3

2" x 2" x 2" H
(51 x 51 x 51mm)



RD-2442N-N3

2" Dia. x 1 1/4" H
(51 Dia. x 32mm)



RD-2455N-N3

8" x 2 1/8" x 2 1/2" H
(203 x 54 x 60mm)

RD-2453N-N3

4 7/8" x 2 1/4" x 2" H
(125 x 57 x 51mm)

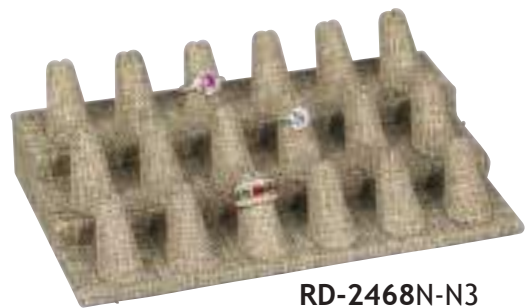

RD-2468N-N3

8 1/4" x 4 3/4" x 2 1/2" H
(210 x 120 x 63mm)

Ring Display Collection

92

Burlap with Lace Ring Displays



BX2470-N31

5" x 5 3/4" x 2" H
(127 x 146 x 50mm)



SET101-N31

6" x 6" x 3 5/8" H
(152 x 152 x 92mm)



8-Pc. Set

RD-5203-N31

Base: 11 3/4" x 3 1/4" x 5/8" H
(298 x 82 x 16mm)

Stage: 1 1/2" x 2" x 1 1/2-3 1/2" H
(38 x 51 x 38-89mm)

■ Linen Ring Displays



195N (LE)
8" x 1 3/4" x 1" H
(206 x 44 x 25mm)



RD-2455N-LE
8" x 2 1/8" x 2 1/2" H
(203 x 54 x 60mm)



RD-2453N-LE
4 7/8" x 2 1/4" x 2" H
(125 x 57 x 51mm)



RD-2444N-LE
2 1/8" x 2 1/8" x 2 3/8" H
(54 x 54 x 60mm)



RD-2441N-LE
2" x 2" x 2" H
(51 x 51 x 51mm)



RD-2462N-LE
8 1/4" x 3 1/4" x 2 1/2" H
(210 x 82 x 63mm)



RD-2442N-LE
2" Dia. x 1 1/4" H
(51 Dia. x 32mm)



4-Pc. Set

201N (LE)
1 3/4" x 1 5/8" x 1 1/4" - 2 1/2" H
(44 x 41 x 32-63mm)



RD-2468N-LE
8 1/4" x 4 3/4" x 2 1/2" H
(210 x 120 x 63mm)

Steel Grey w/Black Faux Leather Trim Ring Displays



Item	Size: W x D x H (mm)
A. F35-1 (87R)	2 1/8" x 2" x 1" (55 x 50 x 25)
B. F35-2 (87R)	2 1/8" x 2" x 1 3/8" (55 x 50 x 35)
C. F35-4 (87R)	5 1/2" x 3 3/4" x 1 1/4" (138 x 95 x 32)
D. F35-5 (87R)	5 1/2" x 3 3/4" x 1 3/8" (138 x 95 x 35)

Item	Size: W x D x H (mm)
E. F35-11 (87R)	6 1/2" x 4 1/2" x 1 1/2" (165 x 114 x 38)
F. F42-6 (87R)	6 1/2" x 4 1/2" x 1 1/2" (165 x 114 x 38)
G. RD104 -87R	1 1/4" x 1 3/8" x 1 5/8" - 3" (32 x 35 x 41-76)

Steel Grey Faux Leather & Beige Suede Displays

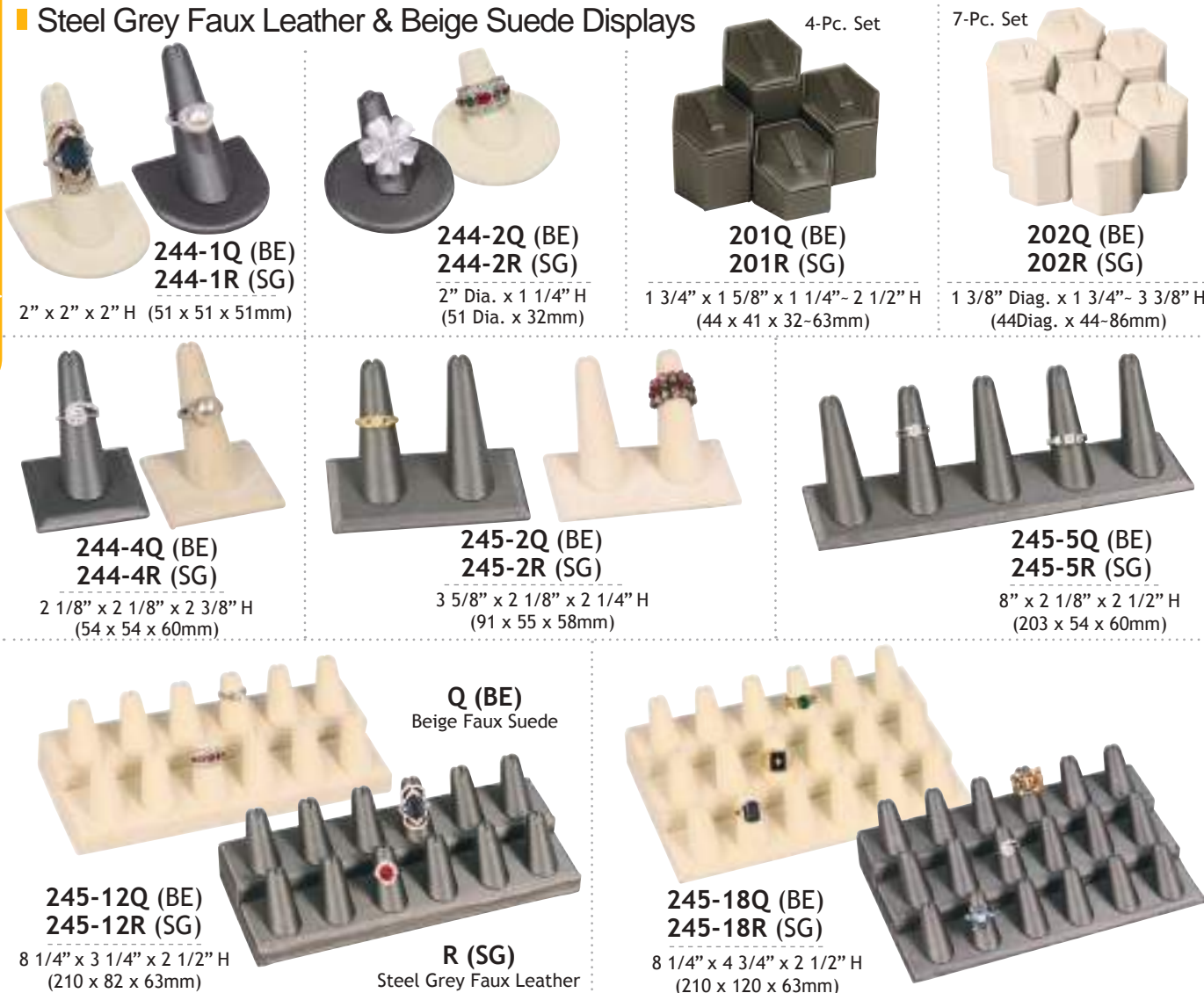

244-1Q (BE)
244-1R (SG)
2" x 2" x 2" H (51 x 51 x 51mm)

244-2Q (BE)
244-2R (SG)
2" Dia. x 1 1/4" H (51 Dia. x 32mm)

201Q (BE)
201R (SG)
1 3/4" x 1 5/8" x 1 1/4" - 2 1/2" H (44 x 41 x 32-63mm)

202Q (BE)
202R (SG)
1 3/8" Diag. x 1 3/4" - 3 3/8" H (44Diag. x 44-86mm)

244-4Q (BE)
244-4R (SG)
2 1/8" x 2 1/8" x 2 3/8" H (54 x 54 x 60mm)

245-2Q (BE)
245-2R (SG)
3 5/8" x 2 1/8" x 2 1/4" H (91 x 55 x 58mm)

245-5Q (BE)
245-5R (SG)
8" x 2 1/8" x 2 1/2" H (203 x 54 x 60mm)

245-12Q (BE)
245-12R (SG)
8 1/4" x 3 1/4" x 2 1/2" H (210 x 82 x 63mm)

Q (BE)
Beige Faux Suede

R (SG)
Steel Grey Faux Leather

245-18Q (BE)
245-18R (SG)
8 1/4" x 4 3/4" x 2 1/2" H (210 x 120 x 63mm)

Double Tube Ring Display



RD-3501 -L30

Premium Beige Faux Leather w/
Steel Brown Faux Leather Trim
3 1/2" x 4" x 2 1/2"
(90 x 102 x 63mm)



* Perfect to display several rings on each tube. Each tube can be easily removed for viewing.



RD-3501 -87R

Steel Grey Faux Leather w/
Black Faux Leather Trim
3 1/2" x 4" x 2 1/2"
(90 x 102 x 63mm)



Multi Ring Display Collection

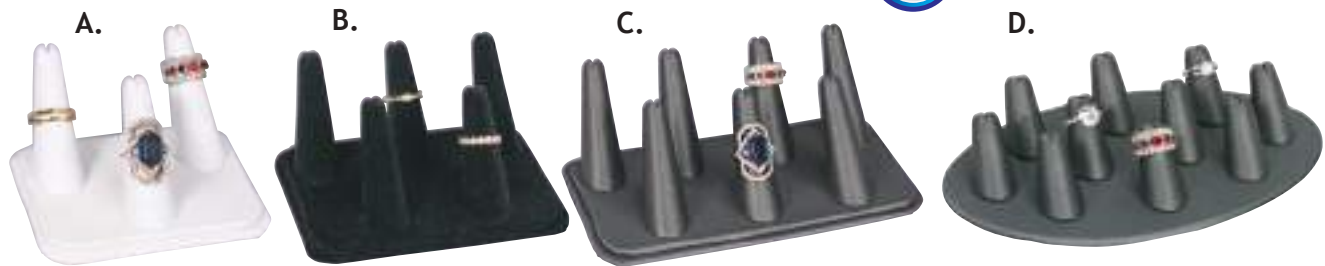

Available Materials

White
Faux Leather
L -WH

Black
Velvet
V -BK

Steel Grey
Faux Leather
R -SG

Item	Size: W x D x H	(mm)
A. RD-2433-Color	4 1/8" x 3 1/4" x 2 1/4"	(105 x 82 x 57)
B. RD-2435-Color	5 1/4" x 3 5/8" x 2 1/4"	(133 x 92 x 57)
C. RD-2437-Color	6 3/4" x 3 1/2" x 2 1/4"	(171 x 89 x 57)
D. 245A-10(Color)	7 1/2" x 4 1/2" x 1 3/8"	(191 x 114 x 35)

Ring Columns



Premium Beige Faux Leather w/
Steel Brown Faux Leather Trim



Steel Grey Faux Leather w/
Black Faux Leather Trim



RD-0143 -L30
RD-0143 -87R

2 1/8" x 2 1/8" x 3 3/8" H
(55 x 55 x 87mm)



RD-0142 -L30
RD-0142 -87R

2 1/8" x 2 1/8" x 2 5/8" H
(55 x 55 x 67mm)



RD-0141 -L30
RD-0141 -87R

2 1/8" x 2 1/8" x 1 7/8" H
(55 x 55 x 47mm)



New Ring Slot Style



RD-0140 -L30
RD-0140 -87R

1 3/8 Dia. x 1 1/2" H
(35 Dia. x 38mm)



Short Finger Displays

2" Dia. x 1 1/4" H
(51 Dia. x 32mm)



3" x 2" x 1 1/4" H
(76 x 51 x 32mm)



10 Fingers

7 1/2" x 4 1/2" x 1 3/8" H
(191 x 114 x 35mm)



Long Finger Displays

1 3/4" x 2 1/2" x 2 3/4" H (44 x 63 x 70mm)



2" x 2" x 2" H (51 x 51 x 51mm)



2 1/8" x 2 1/8" x 2 3/8" H
(54 x 54 x 60mm)



2 Fingers 3 5/8" x 2 1/8" x 2 1/4" H (91 x 55 x 58mm)



3 Fingers 4 7/8" x 2 1/4" x 2" H (124 x 57 x 51mm)



4 Fingers 6" x 2 1/8" x 2 1/2" H (152 x 54 x 60mm)



5 Fingers 8" x 2 1/8" x 2 1/2" H (203 x 54 x 60mm)



3 Fingers

5" x 3 1/4" x 1 5/8" H (127 x 82 x 41mm)



245T-3 (BK)
Black Velvet

245T-3L (W)
White Faux Leather

6 Fingers

7" x 3 1/4" x 1 1/2" H (178 x 82 x 38mm)



245T-6 (BK)
Black Velvet

245T-6L (W)
White Faux Leather

6 Fingers

7 5/8" x 2 1/8" x 1 5/8" H (194 x 54 x 41mm)



245-6 (BK)
Black Velvet

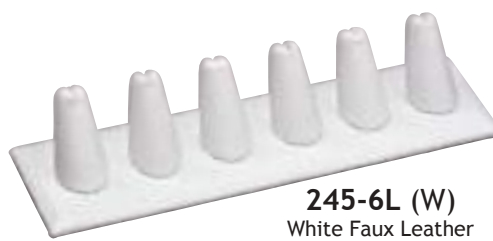

245-6L (W)
White Faux Leather



Our #1-2P & #1-2 trays can hold 6 of #245-6 (BK) or 245-6L (W).

11 Fingers

11 1/8" x 3 3/8" x 2 1/8" H (283 x 85 x 54mm)



245-11 (BK)
Black Velvet



245-11L (W)
White Faux Leather

12 Fingers

8 1/4" x 3 1/4" x 2 1/2" H (210 x 82 x 63mm)



245-12 (BK)
Black Velvet

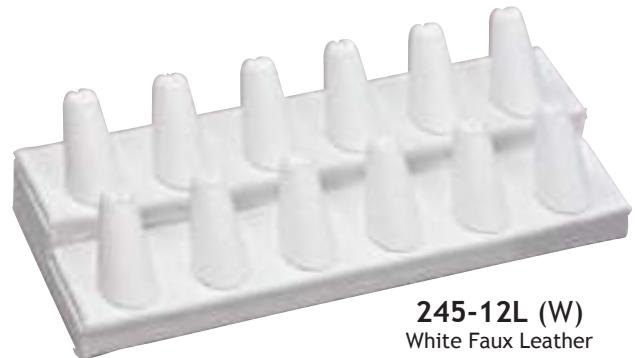

245-12L (W)
White Faux Leather

18 Fingers

8 1/4" x 4 3/4" x 2 1/2" H (210 x 120 x 63mm)



245-18 (BK)
Black Velvet



245-18L (W)
White Faux Leather

Multi-Ring Display
12" x 3 3/4" x 7" H (305 x 95 x 178mm)



Set 124-1 (Color)
24-Ring Clip Set



Set 125 (Color)
40-Ring Slot Set

Available Colors

Grey Faux Suede with Black Leather Trim (BK, G)
Beige Faux Suede with Dark Brown Leather Trim (74L)

Create Your Own Look

* This mini set allows for maximum display capabilities in small windows or display cases.

5-Slot Ring Stand
8 1/8" x 1 3/4" x 1" H (206 x 44 x 25mm)



12-Slot Ring Tray
5" x 5 3/4" x 2" H (127 x 146 x 50mm)



18-Slot Ring Tray
8 1/4" x 4 1/2" x 1 3/4" H (208 x 113 x 45mm)



Ring Column Set

2 1/4" x 1 1/2" x 1 3/8"- 5" H
(58 x 38 x 35-127mm)

6-Pc. Set

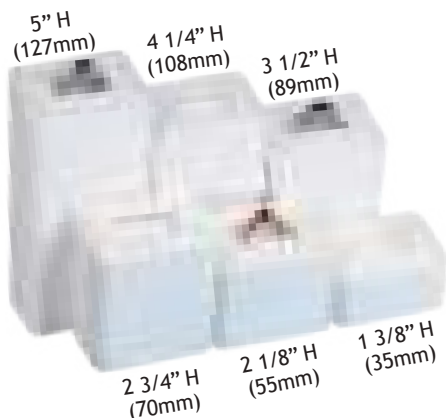

RD5201L -WH
White Faux Leather

Ring Column

1 1/2" W x 1 1/2" D (38 x 38mm)

Clip



F4-11 (W,W) F4-10 (W,W) F4-9 (W,W)
2 1/2" H (63mm) 2 7/8" H (73mm) 3 3/8" H (88mm)

Slot



RD103L -WH RD102L -WH RD101L -WH
2 3/4" H (70mm) 3 1/8" H (80mm) 3 3/8" H (88mm)

Ring Tower

5 1/4" W x 3 3/4" D x 3 3/4" H
(133 x 95 x 95mm)

Clip



203L (W)
White Faux Leather

Slot



RD203L -WH
White Faux Leather

Available Colors



Black Faux Leather
(BK)



White Faux Leather
(W)

Faux Leather Ring Clip

7-Pc. Set



202L (Color)

1 3/4" Diag. x 1 3/4"- 3 3/8" H
(44Diag. x 44-86mm)

Sold Individually



25-2L (Color)
3 5/8" H
(92mm)

25-1L (Color)
2 3/8" H
(60mm)

25 (Color)
1 1/4" H
(32mm)



4-Pc. Set

201L (Color)

1 3/4" x 1 5/8" x 1 1/4"- 2 1/2" H
(44 x 41 x 32-63mm)

Black Velvet Ring Clip

4-Pc. Set



201 (BK)

1 3/4" x 1 5/8" x 1 1/4"- 2 1/2" H
(44 x 41 x 32-63mm)

7-Pc. Set



202 (BK)

1 3/4" Diag. x 1 3/4"- 3 3/8" H
(44Diag. x 44-86mm)

Sold Individually



25-2C (BK)
3 5/8" H (92mm)

25-1C (BK)
2 3/8" H
(60mm)

25C (BK)
1 1/4" H (32mm)

Wooden Ring Clip Wedge Stand

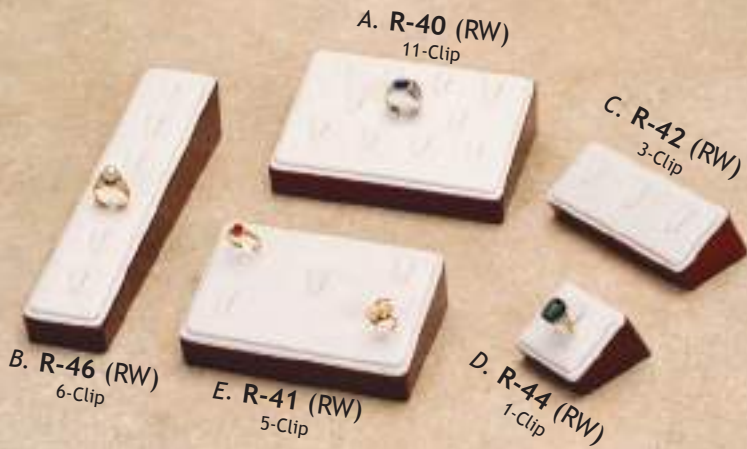

Rosewood Trim Ring Display



Item	Size: W x D x H (mm)
A. R-40 (RW)	6" x 4 1/2" x 1 1/2" (152 x 115 x 38)
B. R-46 (RW)	2" x 9 1/2" x 1 3/4" (50 x 242 x 46)
C. R-42 (RW)	4 1/2" x 2 3/8" x 1 1/2" (114 x 60 x 38)
D. R-44 (RW)	2" x 2 3/8" x 1 3/4" (51 x 60 x 44)
E. R-41 (RW)	5 1/2" x 3 7/8" x 1 1/2" (140 x 98 x 38)

Item	Size: W x D x H (mm)
F. F35-1 (RW)	2 1/8" x 2" x 1" (55 x 51 x 25)
G. F35-4 (RW)	5 1/2" x 3 3/4" x 1 1/4" (138 x 95 x 32)
H. F42-2 (RW)	3 1/2" x 2 1/4" x 1" (89 x 57 x 25)
I. F42-6 (RW)	6 1/2" x 4 1/2" x 1 1/2" (165 x 114 x 38)

Ring Display Collection

100

Wooden Ring Column



Round Ring Display

RD-1515 -Color
1 3/4" Dia. x 1 3/8" (46 Dia. x 35mm)

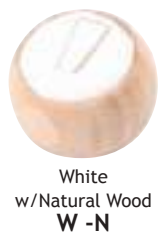

Wedge Stands with Ring Clip



Wedge Stands with Ring Slot

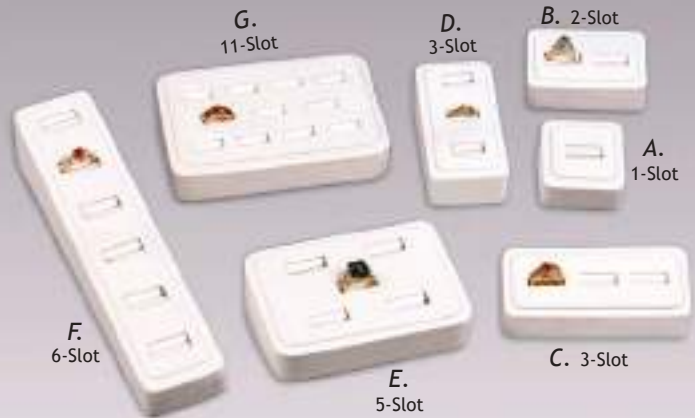

Ring Clip

White
Faux Leather
-WH



Steel Grey w/
Black Faux Leather Trim
(87R)



Ring Slot

White
Faux Leather
-WH

Item	Size: W x D x H (mm)
A. GR-40 (Color)	6 1/4" x 4 3/8" x 1 3/4" (158 x 110 x 43)
B. GR-41 (Color)	5 1/4" x 3 3/4" x 1 3/4" (134 x 96 x 43)
C. GR-42 (Color)	4 3/4" x 2 1/8" x 1 3/4" (120 x 54 x 43)
D. GR-43 (Color)	3 3/8" x 2 1/8" x 1 3/4" (88 x 55 x 43)
E. GR-44 (Color)	2 1/8" x 2 1/4" x 1 5/8" (55 x 57 x 41)
F. GR-46 (Color)	2 1/4" x 9 3/4" x 1 3/4" (56 x 248 x 43)
G. GR-47 (Color)	2 1/8" x 4 3/4" x 1 3/4" (54 x 122 x 43)

Item	Size: W x D x H (mm)
A. RD141L -WH	2 1/8" x 2 1/4" x 1 5/8" (55 x 57 x 41)
B. RD142L -WH	3 3/8" x 2 1/8" x 1 3/4" (88 x 55 x 43)
C. RD143L -WH	4 3/4" x 2 1/8" x 1 3/4" (122 x 54 x 43)
D. RD144L -WH	2 1/8" x 4 3/4" x 1 3/4" (54 x 122 x 43)
E. RD145L -WH	5 1/4" x 3 3/4" x 1 3/4" (134 x 96 x 43)
F. RD146L -WH	2 1/4" x 9 3/4" x 1 3/4" (56 x 248 x 43)
G. RD149L -WH	6 1/4" x 4 3/8" x 1 3/4" (158 x 110 x 43)

Ring Column

2 3/8" Dia. (60mm Dia.)



Black
Faux Leather
(BK)

White
Faux Leather
(W)

237-L1 (Color) 2" H (50mm) 237-L2 (Color) 2 3/4" H (70mm) 237-L3 (Color) 3 1/2" H (90mm)

Ring Clamp Stand

2" Dia. x 2 3/8" H (50 Dia. x 60mm)



* Features tip-resistant base and two ring display options.

240-4L (W)
White Faux Leather

240-4
Black Velvet

Ring Columns Set

Base: 11 3/4" x 3 1/4" x 5/8" H (298 x 82 x 16mm)
Stage: 1 1/2" x 2" x 1 1/2" - 3 1/2" H (38 x 51 x 38 - 89mm)



RD5203 -BK
Black Velvet



8-Pc. Set

RD5203L -WH
White Faux Leather

Tiered Ring Display

11 1/4" W x 5 7/8" D x 5 1/8" H (285 x 150 x 130mm)

29-Ring

RD2701L -WH
White Faux Leather



Disassembles into individual pieces making it much easier to store when transporting or not in use.

Wooden Wedding Band Tray

13 3/4" x 6 3/8" x 7/8 - 2" H (348 x 160 x 23 - 51mm)



TY-2004 (W)
White Faux Leather

Lightweight Ring Trays w/Easel

6 1/2" x 6 1/2" x 7/8" H (165 x 165 x 22mm)

24-Slot

- * Lie flat, or stand upright using the fold out easel on back.
- * Plastic tray with ring foam.



TY-2031 (BK,BK)
Black Foam w/ Black Tray

Lightweight Tiered Ring Display

Light weight plastic tray with foam insert.

11" x 5 1/2" x 1 7/8" H (280 x 140 x 47mm)

PT270 (BK,BK)
Black Foam w/ Black Tray

36-Slot



PT270 (BK,W)
Black Foam w/ White Tray

Lightweight Birthstone Tray

7 1/4" x 6 1/2" x 7/8" H (184 x 165 x 22mm)



TY-2001 (W)
12-Month Ring Tray

Double Ring Display

2 1/4" x 2 1/2" x 1" H (56 x 65 x 25mm)



J-810 (BK)
White Faux Leather
with Black Trim

Plastic Ring Clip

* Holds ring at perfect angle.



1118
5/8" x 1 3/8" x 1/4" H
(16 x 35 x 6mm)

Cut Corner Display

2 1/2" x 2 1/2" x 1 1/2" H
(64 x 64 x 38mm)



RD-232L -WH
White Faux Leather

Ring Flower

3" Dia. (76mm)



RD-351L -WH
White Faux Leather

RD-351L -BK
Black Faux Leather

Single Ring Display

- * Made of faux leather covered metal base.
- * Perfect for rings of all sizes!



Ring Card Insert * Secure your rings with these new ring cards.

Flat: 1 1/8" x 1 3/4" (30 x 46mm)

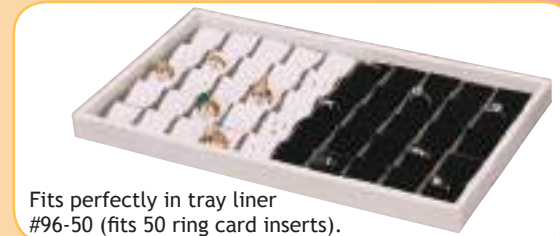

"Sold" Ring

- * "SOLD" ring fits on finger displays or ring foam.

7/8" x 3/4" Dia. (22 x 20mm)

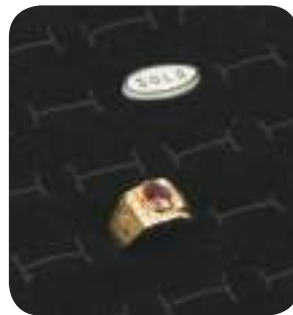

"Sold" Tag

- * Keep track of how many rings you've sold with handy "SOLD" plugs.

7/8" x 1/2" Dia. (22 x 13mm)



Washable Soft Rubber Display

1 3/8" x 2 1/4" x 2 1/8" H (35 x 57 x 54mm)



Rectangular Base



2" x 1 5/8" x 2 1/8" H (50 x 41 x 54mm)

Concave Base



Burlap Ring Displays



195N-N3

8 1/8" x 1 3/4" x 1" H
(206 x 44 x 25mm)



RD-2444N-N3

2 1/8" x 2 1/8" x 2 3/8" H
(54 x 54 x 60mm)



RD-2441N-N3

2" x 2" x 2" H
(51 x 51 x 51mm)



RD-2442N-N3

2" Dia. x 1 1/4" H
(51 Dia. x 32mm)

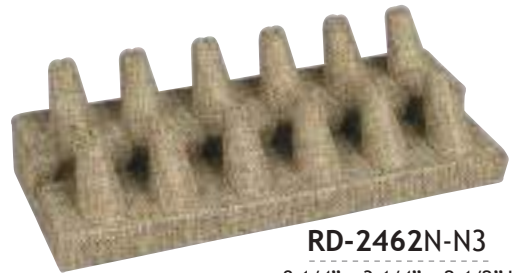

RD-2462N-N3

8 1/4" x 3 1/4" x 2 1/2" H
(210 x 82 x 63mm)



RD-2455N-N3

8" x 2 1/8" x 2 1/2" H
(203 x 54 x 60mm)

RD-2453N-N3

4 7/8" x 2 1/4" x 2" H
(125 x 57 x 51mm)

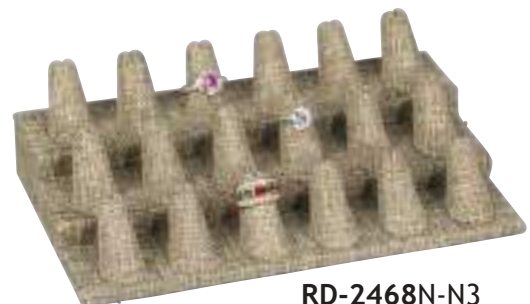

RD-2468N-N3

8 1/4" x 4 3/4" x 2 1/2" H
(210 x 120 x 63mm)

Burlap with Lace Ring Displays



BX2470-N31

5" x 5 3/4" x 2" H
(127 x 146 x 50mm)



SET101-N31

6" x 6" x 3 5/8" H
(152 x 152 x 92mm)



8-Pc. Set

RD-5203-N31

Base: 11 3/4" x 3 1/4" x 5/8" H
(298 x 82 x 16mm)

Stage: 1 1/2" x 2" x 1 1/2-3 1/2" H
(38 x 51 x 38-89mm)

■ Linen Ring Displays



195N (LE)

8" x 1 3/4" x 1" H
(206 x 44 x 25mm)



RD-2455N-LE

8" x 2 1/8" x 2 1/2" H
(203 x 54 x 60mm)



RD-2453N-LE

4 7/8" x 2 1/4" x 2" H
(125 x 57 x 51mm)



RD-2444N-LE

2 1/8" x 2 1/8" x 2 3/8" H
(54 x 54 x 60mm)



RD-2441N-LE

2" x 2" x 2" H
(51 x 51 x 51mm)



RD-2462N-LE

8 1/4" x 3 1/4" x 2 1/2" H
(210 x 82 x 63mm)



RD-2442N-LE

2" Dia. x 1 1/4" H
(51 Dia. x 32mm)



4-Pc. Set

201N (LE)

1 3/4" x 1 5/8" x 1 1/4" - 2 1/2" H
(44 x 41 x 32-63mm)



RD-2468N-LE

8 1/4" x 4 3/4" x 2 1/2" H
(210 x 120 x 63mm)

Steel Grey w/Black Faux Leather Trim Ring Displays



Item	Size: W x D x H (mm)
A. F35-1 (87R)	2 1/8" x 2" x 1" (55 x 50 x 25)
B. F35-2 (87R)	2 1/8" x 2" x 1 3/8" (55 x 50 x 35)
C. F35-4 (87R)	5 1/2" x 3 3/4" x 1 1/4" (138 x 95 x 32)
D. F35-5 (87R)	5 1/2" x 3 3/4" x 1 3/8" (138 x 95 x 35)

Item	Size: W x D x H (mm)
E. F35-11 (87R)	6 1/2" x 4 1/2" x 1 1/2" (165 x 114 x 38)
F. F42-6 (87R)	6 1/2" x 4 1/2" x 1 1/2" (165 x 114 x 38)
G. RD104 -87R	1 1/4" x 1 3/8" x 1 5/8" - 3" (32 x 35 x 41-76)

Steel Grey Faux Leather & Beige Suede Displays

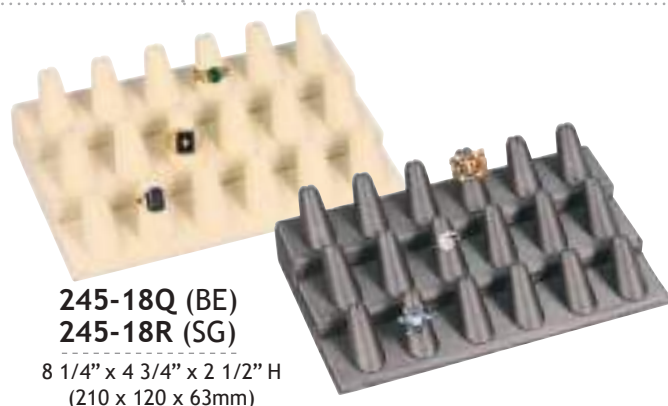
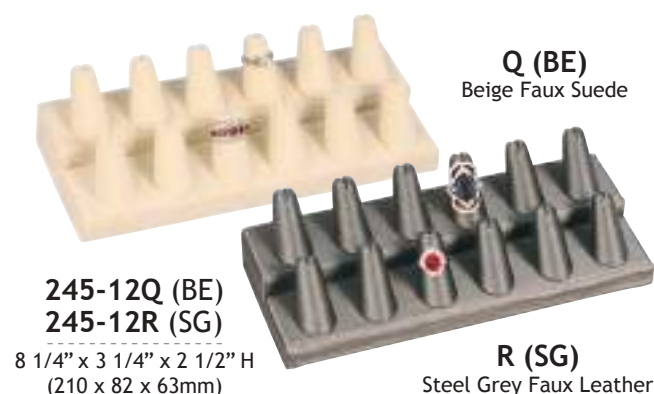

Double Tube Ring Display



RD-3501 -L30

Premium Beige Faux Leather w/
Steel Brown Faux Leather Trim
3 1/2" x 4" x 2 1/2"
(90 x 102 x 63mm)



* Perfect to display several rings on each tube. Each tube can be easily removed for viewing.



RD-3501 -87R

Steel Grey Faux Leather w/
Black Faux Leather Trim
3 1/2" x 4" x 2 1/2"
(90 x 102 x 63mm)



Multi Ring Display Collection

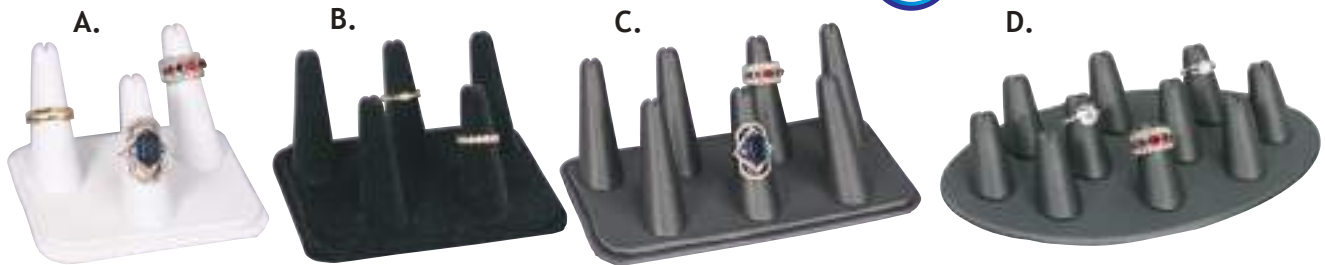

Available Materials

White
Faux Leather
L -WH

Black
Velvet
V -BK

Steel Grey
Faux Leather
R -SG

Item	Size: W x D x H	(mm)
A. RD-2433-Color	4 1/8" x 3 1/4" x 2 1/4"	(105 x 82 x 57)
B. RD-2435-Color	5 1/4" x 3 5/8" x 2 1/4"	(133 x 92 x 57)
C. RD-2437-Color	6 3/4" x 3 1/2" x 2 1/4"	(171 x 89 x 57)
D. 245A-10(Color)	7 1/2" x 4 1/2" x 1 3/8"	(191 x 114 x 35)

Ring Columns



Premium Beige Faux Leather w/
Steel Brown Faux Leather Trim



Steel Grey Faux Leather w/
Black Faux Leather Trim



RD-0143 -L30
RD-0143 -87R

2 1/8" x 2 1/8" x 3 3/8" H
(55 x 55 x 87mm)



RD-0142 -L30
RD-0142 -87R

2 1/8" x 2 1/8" x 2 5/8" H
(55 x 55 x 67mm)



RD-0141 -L30
RD-0141 -87R

2 1/8" x 2 1/8" x 1 7/8" H
(55 x 55 x 47mm)



New Ring Slot Style



RD-0140 -L30
RD-0140 -87R

1 3/8 Dia. x 1 1/2" H
(35 Dia. x 38mm)



Short Finger Displays

2" Dia. x 1 1/4" H
(51 Dia. x 32mm)



3" x 2" x 1 1/4" H
(76 x 51 x 32mm)



10 Fingers

7 1/2" x 4 1/2" x 1 3/8" H
(191 x 114 x 35mm)



Long Finger Displays

1 3/4" x 2 1/2" x 2 3/4" H (44 x 63 x 70mm)



2" x 2" x 2" H (51 x 51 x 51mm)



2 1/8" x 2 1/8" x 2 3/8" H
(54 x 54 x 60mm)



2 Fingers 3 5/8" x 2 1/8" x 2 1/4" H (91 x 55 x 58mm)



3 Fingers 4 7/8" x 2 1/4" x 2" H (124 x 57 x 51mm)



4 Fingers 6" x 2 1/8" x 2 1/2" H (152 x 54 x 60mm)



5 Fingers 8" x 2 1/8" x 2 1/2" H (203 x 54 x 60mm)



3 Fingers

5" x 3 1/4" x 1 5/8" H (127 x 82 x 41mm)



245T-3 (BK)
Black Velvet

245T-3L (W)
White Faux Leather

6 Fingers

7" x 3 1/4" x 1 1/2" H (178 x 82 x 38mm)



245T-6 (BK)
Black Velvet

245T-6L (W)
White Faux Leather

6 Fingers

7 5/8" x 2 1/8" x 1 5/8" H (194 x 54 x 41mm)



245-6 (BK)
Black Velvet

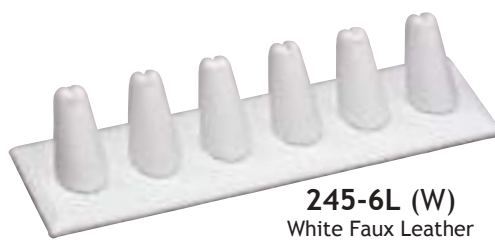

245-6L (W)
White Faux Leather



Our #1-2P & #1-2 trays can hold 6 of #245-6 (BK) or 245-6L (W).

11 Fingers

11 1/8" x 3 3/8" x 2 1/8" H (283 x 85 x 54mm)



245-11 (BK)
Black Velvet



245-11L (W)
White Faux Leather

12 Fingers

8 1/4" x 3 1/4" x 2 1/2" H (210 x 82 x 63mm)



245-12 (BK)
Black Velvet



245-12L (W)
White Faux Leather

18 Fingers

8 1/4" x 4 3/4" x 2 1/2" H (210 x 120 x 63mm)



245-18 (BK)
Black Velvet



245-18L (W)
White Faux Leather

Multi-Ring Display
12" x 3 3/4" x 7" H (305 x 95 x 178mm)



Set 124-1 (Color)
24-Ring Clip Set



Set 125 (Color)
40-Ring Slot Set

Available Colors

Grey Faux Suede with Black Leather Trim (BK, G) Beige Faux Suede with Dark Brown Leather Trim (74L)

Create Your Own Look

* This mini set allows for maximum display capabilities in small windows or display cases.

5-Slot Ring Stand
8 1/8" x 1 3/4" x 1" H (206 x 44 x 25mm)



12-Slot Ring Tray
5" x 5 3/4" x 2" H (127 x 146 x 50mm)



BX2470L -74L Beige Faux Suede w/Dark Brown Faux Leather Trim **BX2470Q -BE** Beige Faux Suede **BX2470R -SG** Steel Grey Faux Leather **BX2470N -LE** Linen **BX2470V -BK** Black Velvet **BX2470L -WH** White Faux Leather

18-Slot Ring Tray
8 1/4" x 4 1/2" x 1 3/4" H (208 x 113 x 45mm)

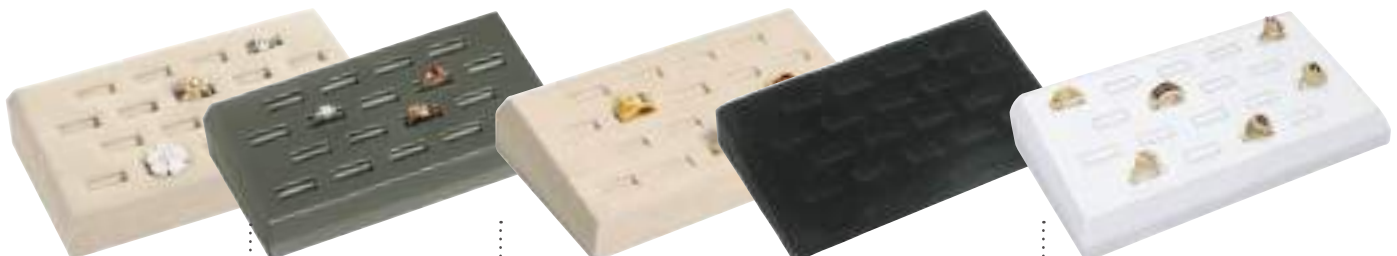

BX2460Q -BE Beige Faux Suede **BX2460R -SG** Steel Grey Faux Leather **BX2460N -LE** Linen **BX2460V -BK** Black Velvet **BX2460L -WH** White Faux Leather

Ring Column Set

2 1/4" x 1 1/2" x 1 3/8"- 5" H
(58 x 38 x 35-127mm)

6-Pc. Set

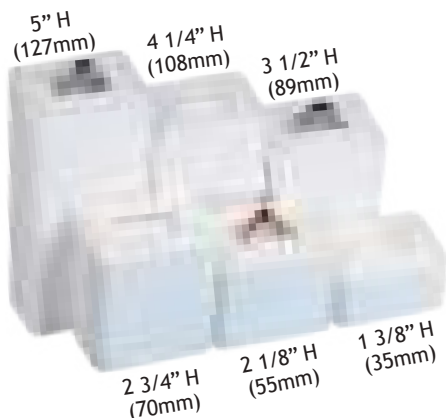

RD5201L -WH
White Faux Leather

Ring Column

1 1/2" W x 1 1/2" D (38 x 38mm)

Clip



F4-11 (W,W) F4-10 (W,W) F4-9 (W,W)
2 1/2" H (63mm) 2 7/8" H (73mm) 3 3/8" H (88mm)

Slot



RD103L -WH RD102L -WH RD101L -WH
2 3/4" H (70mm) 3 1/8" H (80mm) 3 3/8" H (88mm)

Ring Tower

5 1/4" W x 3 3/4" D x 3 3/4" H
(133 x 95 x 95mm)

Clip



203L (W)
White Faux Leather

Slot



RD203L -WH
White Faux Leather

Available Colors



Black Faux Leather
(BK)



White Faux Leather
(W)

Faux Leather Ring Clip

7-Pc. Set



202L (Color)
1 3/4" Diag. x 1 3/4"- 3 3/8" H
(44Diag. x 44-86mm)

Sold Individually



25-2L (Color)
3 5/8" H
(92mm)

25-1L (Color)
2 3/8" H
(60mm)

25 (Color)
1 1/4" H
(32mm)



201L (Color)
1 3/4" x 1 5/8" x 1 1/4"- 2 1/2" H
(44 x 41 x 32-63mm)

4-Pc. Set

Black Velvet Ring Clip

4-Pc. Set



201 (BK)
1 3/4" x 1 5/8" x 1 1/4"- 2 1/2" H
(44 x 41 x 32-63mm)

7-Pc. Set



202 (BK)
1 3/4" Diag. x 1 3/4"- 3 3/8" H
(44Diag. x 44-86mm)

Sold Individually



25-2C (BK)
3 5/8" H (92mm)

25-1C (BK)
2 3/8" H
(60mm)

25C (BK)
1 1/4" H (32mm)

Wooden Ring Clip Wedge Stand

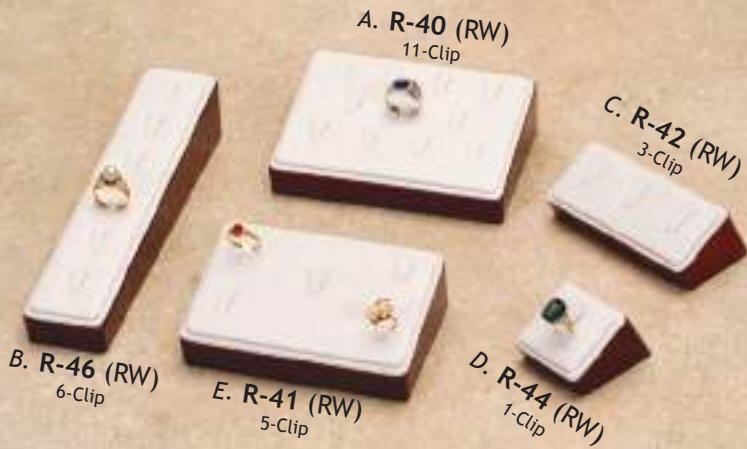

Rosewood Trim Ring Display



Item	Size: W x D x H (mm)
A. R-40 (RW)	6" x 4 1/2" x 1 1/2" (152 x 115 x 38)
B. R-46 (RW)	2" x 9 1/2" x 1 3/4" (50 x 242 x 46)
C. R-42 (RW)	4 1/2" x 2 3/8" x 1 1/2" (114 x 60 x 38)
D. R-44 (RW)	2" x 2 3/8" x 1 3/4" (51 x 60 x 44)
E. R-41 (RW)	5 1/2" x 3 7/8" x 1 1/2" (140 x 98 x 38)

Item	Size: W x D x H (mm)
F. F35-1 (RW)	2 1/8" x 2" x 1" (55 x 51 x 25)
G. F35-4 (RW)	5 1/2" x 3 3/4" x 1 1/4" (138 x 95 x 32)
H. F42-2 (RW)	3 1/2" x 2 1/4" x 1" (89 x 57 x 25)
I. F42-6 (RW)	6 1/2" x 4 1/2" x 1 1/2" (165 x 114 x 38)

Ring Display Collection

100

Wooden Ring Column



Round Ring Display

RD-1515 -Color

1 3/4" Dia. x 1 3/8" (46 Dia. x 35mm)

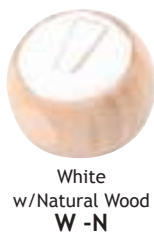

Wedge Stands with Ring Clip



Wedge Stands with Ring Slot

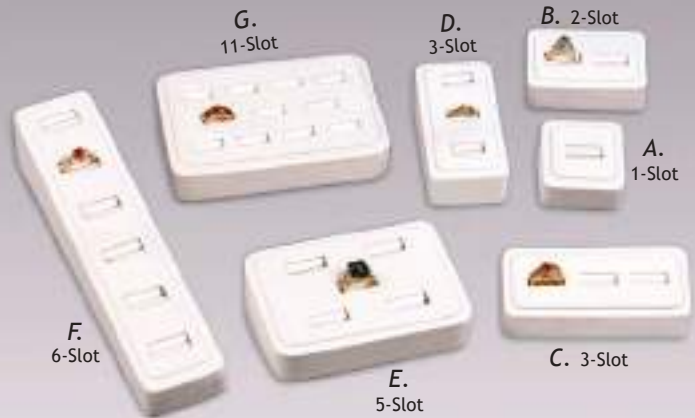

Ring Clip

White
Faux Leather
-WH



Steel Grey w/
Black Faux Leather Trim
(87R)



Ring Slot

White
Faux Leather
-WH

Item	Size: W x D x H (mm)
A. GR-40 (Color)	6 1/4" x 4 3/8" x 1 3/4" (158 x 110 x 43)
B. GR-41 (Color)	5 1/4" x 3 3/4" x 1 3/4" (134 x 96 x 43)
C. GR-42 (Color)	4 3/4" x 2 1/8" x 1 3/4" (120 x 54 x 43)
D. GR-43 (Color)	3 3/8" x 2 1/8" x 1 3/4" (88 x 55 x 43)
E. GR-44 (Color)	2 1/8" x 2 1/4" x 1 5/8" (55 x 57 x 41)
F. GR-46 (Color)	2 1/4" x 9 3/4" x 1 3/4" (56 x 248 x 43)
G. GR-47 (Color)	2 1/8" x 4 3/4" x 1 3/4" (54 x 122 x 43)

Item	Size: W x D x H (mm)
A. RD141L -WH	2 1/8" x 2 1/4" x 1 5/8" (55 x 57 x 41)
B. RD142L -WH	3 3/8" x 2 1/8" x 1 3/4" (88 x 55 x 43)
C. RD143L -WH	4 3/4" x 2 1/8" x 1 3/4" (122 x 54 x 43)
D. RD144L -WH	2 1/8" x 4 3/4" x 1 3/4" (54 x 122 x 43)
E. RD145L -WH	5 1/4" x 3 3/4" x 1 3/4" (134 x 96 x 43)
F. RD146L -WH	2 1/4" x 9 3/4" x 1 3/4" (56 x 248 x 43)
G. RD149L -WH	6 1/4" x 4 3/8" x 1 3/4" (158 x 110 x 43)

Ring Column

2 3/8" Dia. (60mm Dia.)



Black
Faux Leather
(BK)

White
Faux Leather
(W)

237-L1 (Color) 2 37-L2 (Color) 237-L3 (Color)
2" H (50mm) 2 3/4" H (70mm) 3 1/2" H (90mm)

Ring Clamp Stand

2" Dia. x 2 3/8" H (50 Dia. x 60mm)



* Features tip-resistant base and two ring display options.

240-4L (W)
White Faux Leather

240-4
Black Velvet

Ring Columns Set

Base: 11 3/4" x 3 1/4" x 5/8" H (298 x 82 x 16mm)
Stage: 1 1/2" x 2" x 1 1/2" - 3 1/2" H (38 x 51 x 38 - 89mm)



RD5203 -BK
Black Velvet



8-Pc. Set

RD5203L -WH
White Faux Leather

Tiered Ring Display

11 1/4" W x 5 7/8" D x 5 1/8" H (285 x 150 x 130mm)

29-Ring

RD2701L -WH
White Faux Leather



Disassembles into individual pieces making it much easier to store when transporting or not in use.

Wooden Wedding Band Tray

13 3/4" x 6 3/8" x 7/8 - 2" H (348 x 160 x 23 - 51mm)



TY-2004 (W)
White Faux Leather

Lightweight Ring Trays w/Easel

6 1/2" x 6 1/2" x 7/8" H (165 x 165 x 22mm)

24-Slot

- * Lie flat, or stand upright using the fold out easel on back.
- * Plastic tray with ring foam.



TY-2031 (BK,BK)
Black Foam w/ Black Tray

Lightweight Tiered Ring Display

Light weight plastic tray with foam insert.
11" x 5 1/2" x 1 7/8" H (280 x 140 x 47mm)

PT270 (BK,BK)
Black Foam w/ Black Tray

36-Slot



PT270 (BK,W)
Black Foam w/ White Tray

Lightweight Birthstone Tray

7 1/4" x 6 1/2" x 7/8" H (184 x 165 x 22mm)



TY-2001 (W)
12-Month Ring Tray

Double Ring Display

2 1/4" x 2 1/2" x 1" H (56 x 65 x 25mm)



J-810 (BK)
White Faux Leather
with Black Trim

Plastic Ring Clip

* Holds ring at perfect angle.



1118
5/8" x 1 3/8" x 1/4" H
(16 x 35 x 6mm)

Cut Corner Display

2 1/2" x 2 1/2" x 1 1/2" H
(64 x 64 x 38mm)



RD-232L -WH
White Faux Leather

Ring Flower

3" Dia. (76mm)



RD-351L -WH
White Faux Leather

RD-351L -BK
Black Faux Leather

Single Ring Display

- * Made of faux leather covered metal base.
- * Perfect for rings of all sizes!

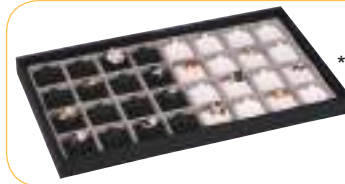

RD-1501R -SG
Steel Grey Faux Leather

1 3/8" x 1 5/8" x 1/2" H
(38 x 41 x 13mm)

RD-1501L -BK
Black Faux Leather

Ring Card Insert * Secure your rings with these new ring cards.

Flat: 1 1/8" x 1 3/4" (30 x 46mm)



"Sold" Ring

- * "SOLD" ring fits on finger displays or ring foam.

7/8" x 3/4" Dia. (22 x 20mm)



"Sold" Tag

- * Keep track of how many rings you've sold with handy "SOLD" plugs.

7/8" x 1/2" Dia. (22 x 13mm)



Washable Soft Rubber Display

1 3/8" x 2 1/4" x 2 1/8" H (35 x 57 x 54mm)



Rectangular Base



2" x 1 5/8" x 2 1/8" H (50 x 41 x 54mm)

Concave Base



Frosted Polystyrenes



Item	Size: W x H (mm)
233-A (WF)	4" x 6 1/2" (102 x 165)
PB21 (WF)	9" x 11 1/2" (228 x 290)
PB19 (WF)	6 7/8" x 12 1/4" (175 x 311)
232 (WF)	3 3/8" x 6 1/4" (86 x 159)
236 (WF)	6" x 13" (150 x 330)
235 (WF)	5 3/4" x 8" (145 x 203)
PB14-1 (WF)	1 1/2" x 4" (38 x 100)

Item	Size: W x H (mm)
250 (WF)	1 3/8" x 6 1/8" (35 x 155)
250-A (WF)	1 1/4" x 5 5/8" (30 x 143)
PB28 (WF)	5 1/2" x 8" (140 x 203)
228M (WF)	4" x 4" (102 x 102)
228F (WF)	3 1/8" x 4" (78 x 102)
PB24 (WF)	6 3/8" x 5 1/4" (162 x 133)
236-B (WF)	5 3/8" x 7 1/2" (136 x 191)

Acrylic Ring Sets

104

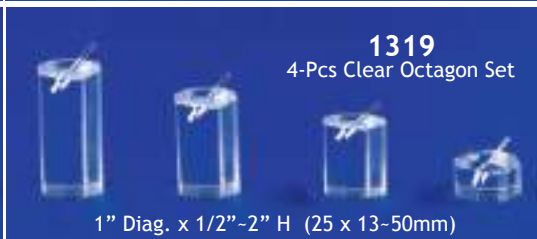
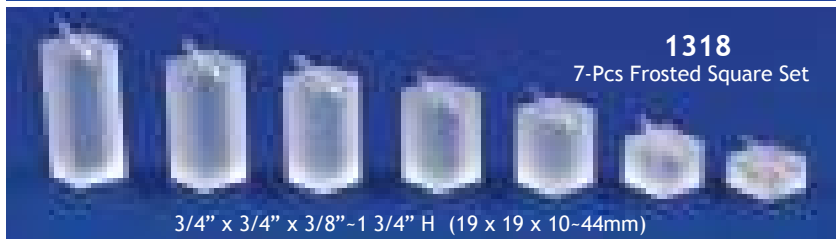
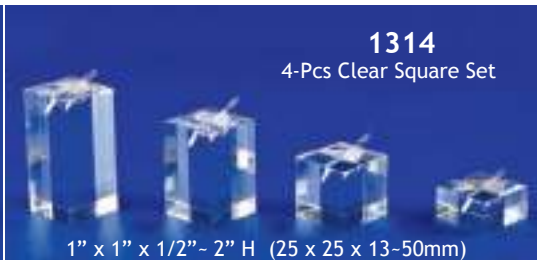
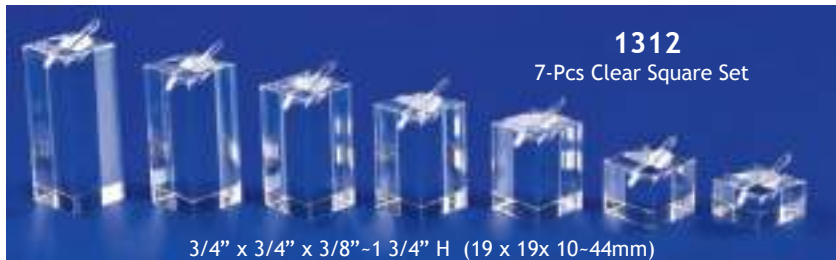
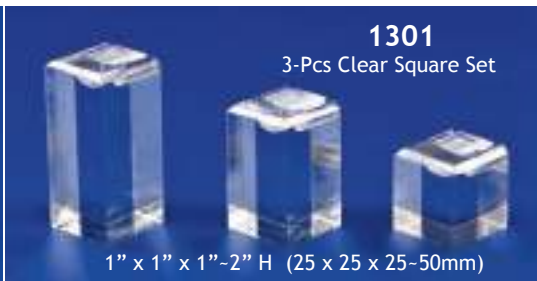
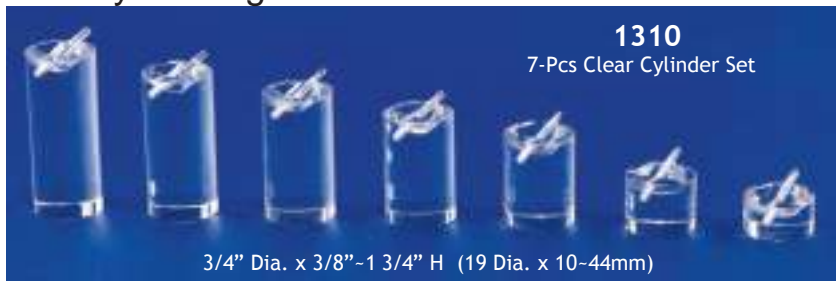



PB-0172P-BK

PB-0172P-WH

Plastic Silhouette Necklace/Earring Display

* Display matching necklace and earring sets on this new contoured display. Made of molded plastic.

Item	Size: W x D x H (mm)
PB-0172P -BK	7" x 2 3/4" x 9" (178 x 70 x 228)
PB-0172P -WH	7" x 2 3/4" x 9" (178 x 70 x 228)

Natural Polystyrenes

Our polystyrene has been textured for a woven look, with a solid and sturdy base for good balance.

PB32 (NU)
6 3/4" x 3" x 8"
(171 x 76 x 203)



PB31 (NU)
10" x 3 1/2" x 11 1/2"
(255 x 90 x 292)



Black & White Polystyrenes



228H (BK)
228H (W)

3 1/2" W x 3 1/2" H
(90 x 89mm)

228F (BK)
228F (W)

3 1/8" W x 4" H
(78 x 102mm)

228M (BK)
228M (W)

4" W x 4" H
(101 x 102mm)



250 (BK)

1 3/8" W x 6 1/8" H
(35 x 155mm)



250-A (W)

1 1/4" W x 5 5/8" H
(30 x 143mm)

Figurine Collection

105

Vintage Polystyrenes



PB18 (VN)



PB28 (VN)



233 (VN)



235 (VN)



234 (VN)



PB17-1 (VN)



232 (VN)

Item	Size: W x D x H (mm)
232 (VN)	3 3/8" x 6 1/4" (86 x 159)
233 (VN)	3 1/2" x 6 1/2" (89 x 165)
234 (VN)	4" x 8" (102 x 203)
235 (VN)	5 3/4" x 8" (145 x 203)
PB17-1 (VN)	6" x 9" (152 x 228)
PB18 (VN)	8 1/4" x 19 1/2" (210 x 495)
PB28 (VN)	5 1/2" x 8" (140 x 203)

Black & White Polystyrenes

Black Polystyrenes (BK)
White Polystyrenes (W)



PB21 (BK)
PB21 (W)
9" W x 11 1/2" H
(228 x 290mm)

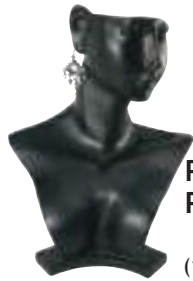

PB29 (BK)
PB29 (W)
7" W x 9" H
(178 x 228mm)



PB19 (BK)
PB19 (W)
6 7/8" W x 12 1/4" H
(175 x 311mm)



PB17-1 (BK)
PB17-1 (W)
6" W x 9" H
(152 x 228mm)



PB28 (BK)
PB28 (W)
5 1/2" W x 8" H
(140 x 203mm)



PB18 (BK)
PB18 (W)
8 1/4" W x 5 1/2" D x 19 1/2" H
(210 x 140 x 495mm)



PB24 (BK)
PB24 (W)
6 3/8" W x 5 1/4" H
(162 x 133mm)



PB27 (BK)
PB27 (W)
4 7/8" W x 4 3/4" H
(124 x 121mm)

Figurine Collection

106



PB22 (BK)
PB22 (W)
8 1/2" W x 6 1/2" H
(215 x 165mm)



232 (BK)
232 (W)
3 3/8" W x 6 1/4" H
(86 x 159mm)

233 (BK)
233 (W)
3 1/2" W x 6 1/2" H
(86 x 165mm)



233-A (BK)
233-A (W)
4" W x 6 1/2" H
(100 x 165mm)



237-B (BK)
1 1/8" W x 5" H
(28 x 127mm)



234 (BK)
234 (W)
4" W x 8" H
(102 x 203mm)



234-A (BK)
234-A (W)
4" W x 8 1/4" H
(102 x 210mm)



235 (BK)
235 (W)
5 3/4" W x 8" H
(145 x 203mm)



236 (BK)
236 (W)
6" W x 13" H
(150 x 330mm)



236-B (BK)
236-B (W)
5 3/8" W x 7 1/2" H
(136 x 191mm)

■ Foldable Necklace Display

* Light weight.
* Easy for storage.

Store Flat High Profile Low Profile

Available Colors

Black Velvet **V-BK** White Faux Leather **L-WH**
Burlap **N-N3** Linen **N-LE**

CD-6725 - Color
6 1/2" x 9" x 7"H or 16 5/8" H
(165 x 228 x 178 or 422mm)



CD-6724 - Color
6 1/2" x 4 5/8" x 3 5/8"H or 7 7/8" H
(165 x 117 x 92 or 200mm)



Pre-cut easel behind the display allows for easy switching between tall or low display profiles.

■ Miniature Body Forms

5 1/2" x 4 1/2" x 22 5/16" H (140 x 115 x 568mm)

* Made of material that allows for easy pinning



MQ-0001-WH

White Body



* 2 changeable Finials Included



MQ-0001-BK

Black Body



* 2 changeable Finials Included



MQ-0002N-N3

Burlap Body

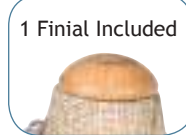

1 Finial Included

■ Necklace Pedestal



ND-1993 -Color
2 5/8" x 2 3/4" x 9 3/4"H
(67 x 70 x 248mm)

ND-1992 -Color
2 5/8" x 2 3/4" x 5 3/4"H
(67 x 70 x 146mm)

Available Colors



Burlap
N-N3



Beige Linen
N-LE



Black Velvet
V-BK



Steel Grey
Faux Leather
R-SG

■ Padded Neck Stand



Available Colors



14"H

ND-1868-Color
10" x 5" x 14" H
(254 x 127 x 356mm)



12 1/2"H

ND-1867-Color
9" x 4 1/2" x 12 1/2" H
(228 x 114 x 317mm)



10 1/2"H

ND-1866-Color
8" x 4" x 10 1/2" H
(203 x 102 x 267mm)



9"H

ND-1865-Color
6 1/2" x 3 1/2" x 9" H
(165 x 89 x 228mm)

* New neckform with easy curve shoulder to hold almost any style necklace



Available Colors

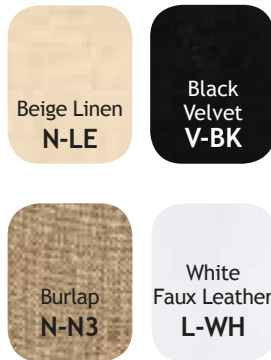

Mannequin Style Stand



ND-1107-Color
9 3/4" x 4 7/8" x 16" H
(248 x 124 x 406mm)

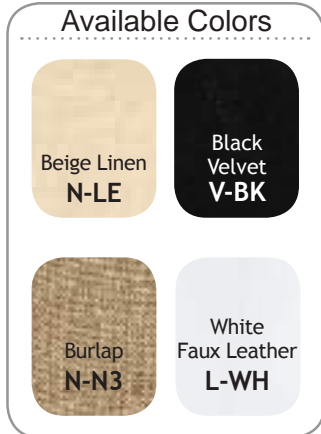

Silhouette Style Stand



ND-1808 -Color
22" H



B. 181 (Color)
14 1/2"

	Black Velvet	White Faux Leather	Steel Grey Faux Leather	Black Faux Leather	Description	Size: W x D x H	(mm)
A	ND-1808V-BK	ND-1808L-WH	ND-1808R-SG	ND-1808L-BK	Extra Tall Necklace Display	11" x 8 7/8" x 22"	(280 x 225 x 555)
B	181 (BK)	181L (W)	181R (SG)	181L (BK)	Tall Necklace Display	8 1/4" x 6 3/4" x 14 1/2"	(210 x 171 x 368)
C	ND-1883-BK	ND-1883L-WH	ND-1883R-SG	ND-1883L-BK	Necklace Display	7 1/2" x 4 1/2" x 11"	(191 x 114 x 279)
D	ND-1882-BK	ND-1882L-WH	ND-1882R-SG	ND-1882L-BK	Short Necklace Display	4 1/2" x 2 1/2" x 5 1/2"	(114 x 63 x 140)

Extra-Tall Necklace Display

D. ND-1818 -Color



E. ND-1808 -Color

B. 181-2 (Color)

C. ND-1813 -Color

* Adjustable angle

A. 181 (Color)



8 1/4" x 6 3/4" x 14 1/2" H
(210 x 171 x 368mm)

9 1/2" x 6 3/8" x 18" H
(241 x 162 x 457mm)

11 1/4" x 7 1/4" x 18" H
(286 x 184 x 457mm)

10" x 6" x 16 3/4" H
(254 x 152 x 425mm)

11" x 8 7/8" x 22" H
(280 x 225 x 555mm)

Available Colors



Item	Black Velvet	Black Faux Leather	White Faux Leather	Steel Grey Faux Leather	Beige Faux Suede	Burlap	Linen
A.	181 (BK)	181L (BK)	181L (W)	181R (SG)	181Q (BE)	181N (N3)	181N (LE)
B.	181-2 (BK)	181-2L (BK)	181-2L (W)	ND-1812R-SG	ND-1812Q-BE	ND-1812N-N3	ND-1812N-LE
C.	ND-1813-BK	ND-1813L-BK	ND-1813L-WH	ND-1813R-SG	ND-1813Q-BE	ND-1813N-N3	ND-1813N-LE
D.	ND-1818-BK	ND-1818L-BK	ND-1818L-WH	ND-1818R-SG	ND-1818Q-BE	ND-1818N-N3	ND-1818N-LE
E.	ND-1808V-BK	ND-1808L-BK	ND-1808L-WH	ND-1808R-SG	ND-1808Q-BE	ND-1808N-N3	ND-1808N-LE

Wood Trim Neckform

* White Faux Leather with Glossy Wood Trim



189-2L (RW)
189-2L (O)
7 1/2" x 5 1/8" x 11" H
(191 x 130 x 280mm)



(O) Oak Wood Trim
(RW) Rosewood Trim

189-7L (RW)
189-7L (O)
6 3/8" x 4 1/2" x 10" H
(162 x 114 x 255mm)



189-3L (RW)
5" x 4 1/8" x 7 1/2" H
(127 x 105 x 190mm)



189-6L (RW)
4" x 3 1/4" x 6 1/4" H
(100 x 83 x 160mm)

Low Profile Wood Trim Neckform

* White Faux Leather with Wood Trim



F4-12 (RW)
4 1/2" x 5 1/2" x 3" H
(115 x 140 x 75mm)



F38-31 (RW)
4 1/8" x 3 3/8" x 3 1/2" H
(105 x 86 x 89mm)



(RW) Rosewood Trim
(O) Oak Wood Trim

ND-312W -RW
ND-312W -O
6 3/4" x 4 3/4" x 5 1/8" H
(171 x 121 x 130mm)



ND-311W -RW
ND-311W -O
5 1/2" x 3 1/2" x 3 3/4" H
(140 x 89 x 95mm)

Pink / Black Velvet Neckform With Zebra Trim



-ZP
Pink Velvet w/
Zebra Trim

-ZR
Black Velvet w/
Zebra Trim

ND-1892V-Color
7 1/2" x 5 1/8" x 11" H
(191 x 130 x 280)



-ZP

-ZR

ND-2886V-Color
5 5/8" x 4 1/2" x 8 1/4" H
(143 x 114 x 210mm)



-ZP

-ZR

ND201V-Color
8 1/2" x 7 1/4" x 6 1/2" H
(216 x 185 x 165mm)

■ Steel Grey Faux Leather Neckforms



ND-1892R-SG
7 1/2" x 5 1/8" x 11" H
(191 x 130 x 280mm)



ND-1897R-SG
6 3/8" x 4 1/2" x 10" H
(162 x 114 x 255mm)



ND-1893R-SG
5" x 4 1/8" x 7 1/2" H
(127 x 105 x 190mm)



ND-1896R-SG
4" x 3 1/4" x 6 1/4" H
(102 x 83 x 159mm)

Necklace Collection

Adjustable
Angle &
Height



ND-2890R-SG
7 1/2" x 8" x 5 1/4" - 8 7/8" H
(191 x 203 x 133 - 225mm)



171-1R (SG)
6 3/4" x 8" x 3 1/2" H
(171 x 203 x 89mm)

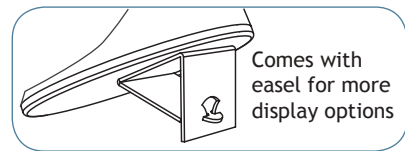

Comes with
easel for more
display options



ND-342R-SG
5 3/4" x 6 1/8" x 4 1/4" H
(146 x 156 x 108mm)



ND-341R-SG
4 1/4" x 4 3/4" x 3 1/2" H
(108 x 121 x 89mm)

112



ND-1808R-SG
11" x 8 7/8" x 22" H
(280 x 225 x 555mm)



181R (SG)
8 1/4" x 6 3/4" x 14 1/2" H
(210 x 171 x 368mm)



ND-2889R-SG
7" x 6" x 13 1/2" H
(178 x 152 x 343mm)



ND-2886CR-SG
5 5/8" x 4 1/2" x 8 1/4" H
(143 x 114 x 210mm)



ND-2886R-SG
5 5/8" x 4 1/2" x 8 1/4" H
(143 x 114 x 210mm)

■ Steel Grey Faux Leather Neckforms



189-2L (87R)
Steel Grey w/ Black Trim
7 1/2" x 5 1/8" x 11" H
(191 x 130 x 280mm)



ND-1102-87R
Steel Grey w/ Black Trim
6" x 4" x 11 1/2" H
(152 x 102 x 292mm)



ND-1101-87R
Steel Grey w/ Black Trim
4 3/4" x 3 1/4" x 7 7/8" H
(121 x 82 x 200mm)



ND1706-87R
Steel Grey w/ Black Trim
7 1/4" x 7" x 6 1/2" H
(184 x 178 x 165mm)



ND-312-87R
Steel Grey w/ Black Trim
6 3/4" x 4 3/4" x 5 1/8" H
(171 x 121 x 130mm)



ND-311-87R
Steel Grey w/ Black Trim
5 1/2" x 3 1/2" x 3 3/4" H
(140 x 89 x 95mm)



F4-12 (87R)
Steel Grey w/ Black Trim
4 1/2" x 5 1/2" x 3" H
(115 x 140 x 75mm)



ND1705-87R
Steel Grey w/ Black Trim
4 3/4" x 5" x 2 3/4" H
(120 x 127 x 70mm)

■ Curved Standing Bust



ND-1842L-WH
White Faux Leather

ND-1842V-BK
Black Velvet

8 1/8" x 3 1/2" x 11 1/4" H (204 x 89 x 286 mm)



Side



Back

■ Linen Beige Neckforms



ND-1721N-LE
7 1/2" x 8 1/2" x 3 3/4" H
(191 x 215 x 95mm)



ND-1722N-LE
6 1/2" x 7 1/2" x 4" H
(165 x 191 x 102mm)



171-1N (LE)
6 3/4" x 8" x 3 1/2" H
(170 x 203 x 89mm)



ND-341N-LE
4 1/4" x 4 3/4" x 3 1/2" H
(108 x 121 x 89 mm)



ND-342N-LE
5 3/4" x 6 1/8" x 4 1/4" H
(146 x 156 x 108 mm)



ND-1868N-LE
10" x 5" x 14" H
(254 x 127 x 356mm)



ND-1867N-LE
9" x 4 1/2" x 12 1/2" H
(228 x 114 x 317mm)



ND-1866N-LE
8" x 4" x 10 1/2" H
(203 x 102 x 267mm)



ND-1865N-LE
6 1/2" x 3 1/2" x 9" H
(165 x 89 x 228mm)

Necklace Collection

114



ND-1108N-LE
10 3/4" x 6 1/2" x 18" H
(273 x 165 x 457mm)



ND-1107N-LE
9 3/4" x 4 7/8" x 16" H
(248 x 124 x 406mm)



ND-1106N-LE
8" x 5" x 13" H
(203 x 127 x 330mm)



ND-1105N-LE
6" x 3 1/2" x 10" H
(152 x 89 x 254mm)

■ Linen Beige Neckforms



ND-1892N-LE
7 1/2" x 5 1/8" x 11" H
(191 x 130 x 280mm)



ND-1897N-LE
6 3/8" x 4 1/2" x 10" H
(162 x 114 x 255mm)



ND-1893N-LE
5" x 4 1/8" x 7 1/2" H
(127 x 105 x 190mm)



ND-1896N-LE
4" x 3 1/4" x 6 1/4" H
(102 x 83 x 159mm)



ND-1850N-LE
6 1/2" x 5 1/2" x 8 1/4" H
(165 x 140 x 210mm)



ND-1102N-LE
6" x 4" x 11 1/2" H
(152 x 102 x 292mm)



ND-1101N-LE
4 3/4" x 3 1/4" x 7 7/8" H
(121 x 82 x 200mm)



XD-2918N-LE
4 1/8" x 3" x 9 1/8" H
(105 x 76 x 232 mm)



ND-1812N-LE
9 1/2" x 6 3/8" x 18" H
(241 x 162 x 470mm)



181N (LE)
8 1/4" x 6 3/4" x 14 1/2" H
(210 x 171 x 368mm)



ND-2889N-LE
7" x 6" x 13 1/2" H
(178 x 152 x 343mm)



ND-2886N-LE
5 5/8" x 4 1/2" x 8 1/4" H
(143 x 114 x 210mm)

■ Burlap Neckforms



NEW

ND-1892N-N3
7 1/2" x 5 1/8" x 11" H
(191 x 130 x 280mm)



NEW

ND-1897N-N3
6 3/8" x 4 1/2" x 10" H
(162 x 114 x 255mm)



NEW

ND-1893N-N3
5" x 4 1/8" x 7 1/2" H
(127 x 105 x 190mm)



NEW

ND-1896N-N3
4" x 3 1/4" x 6 1/4" H
(102 x 83 x 159mm)



NEW

ND-1108N-N3
10 3/4" x 6 1/2" x 18" H
(273 x 165 x 457mm)



NEW

ND-1107N-N3
9 3/4" x 4 7/8" x 16" H
(248 x 124 x 406mm)



NEW

ND-1106N-N3
8" x 5" x 13" H
(203 x 127 x 330mm)



NEW

ND-1105N-N3
6" x 3 1/2" x 10" H
(152 x 89 x 254mm)



NEW

NC-1021N-N3
7 1/4" x 8 1/2" x 4 7/8" H
(184 x 216 x 124mm)



NEW

ND-1721N-N3
7 1/2" x 8 1/2" x 3 3/4" H
(191 x 215 x 95mm)



NEW

171-1N (N3)
6 3/4" x 8" x 3 1/2" H
(170 x 203 x 89mm)



NEW

ND-1722N-N3
6 1/2" x 7 1/2" x 4" H
(165 x 191 x 102mm)

■ Burlap Neckforms



Adjustable

ND-1812N-N3

9 1/2" x 6 3/8" x 18" H
(241 x 162 x 470mm)



181N (N3)

8 1/4" x 6 3/4" x 14 1/2" H
(210 x 171 x 368mm)



ND-2889N-N3

7" x 6" x 13 1/2" H
(178 x 152 x 343 mm)



ND-2886N-N3

5 5/8" x 4 1/2" x 8 1/4" H
(143 x 114 x 210mm)



XD-2918N-N3

4 1/8" x 3" x 9 1/8" H
(105 x 76 x 232mm)



XD-2992N-N3

3 1/2" x 2 3/4" x 5 1/2" H
(89 x 70 x 140mm)



ND-1850N-N3

6 1/2" x 5 1/2" x 8 1/4" H
(165 x 140 x 210mm)



Adjustable

ND-1991N-N3

2 3/4" x 3 1/2" x 12" H
(89 x 70 x 305mm)

Burlap with Lace



ND-1892-N31

Burlap w/Lace
7 1/2" x 5 1/8" x 11" H
(191 x 130 x 279 mm)



ND-2886-N31

Burlap w/Lace
5 5/8" x 4 1/2" x 8 1/4" H
(143 x 114 x 210mm)



Adjustable
Height
and Angle

ND-2890N-N3

7 1/2" x 8" x 5 1/4" - 8 7/8" H
(191 x 203 x 133 - 225mm)

Mini Neckform



1 3/4" x 2 3/4" x 2 1/8" H (70 x 44 x 54mm)



ND3312L -WH
White Faux Leather



ND3312 -BK
Black Velvet

Low Profile Neckform Display

6" x 5" x 5" H (152 x 127 x 127mm)



189-5L (BK)
Black Faux Leather



189-5L (W)
White Faux Leather



189-5 (BK)
Black Velvet

5-Tier Necklace Platform

10 1/4" x 9 1/8" x 2 3/4" H (260 x 232 x 70mm)



ND195L -WH
White Faux Leather

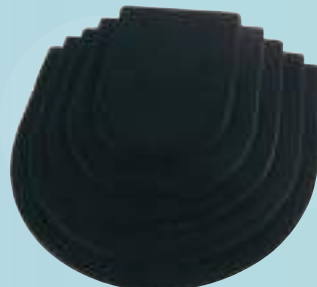

ND195V -BK
Black Velvet

* Excess chain storage on back.



3" x 3 3/4" x 2 1/8" H (76 x 95 x 54mm)



ND2311 -WH
White Faux Leather



ND2311V -BK
Black Velvet

2 7/8" x 3 1/8" x 2 1/2" H (73 x 79 x 63mm)



ND3311 -WH
White Faux Leather



ND3311V -BK
Black Velvet

2 1/2" x 1 5/8" x 2 5/8" H (64 x 41 x 69mm)



182-4L (W)
White Faux Leather



182-4 (BK)
Black Velvet

Grey Suede w/Black Trim



ND-0552-BK,G
7 3/4" x 2 1/8" x 7 3/4" H
(195 x 55 x 195mm)



ND-0551-BK,G
3" x 2" x 3 1/2" H
(77 x 51 x 90mm)

Neckform Display



F4-15 (W, W)
White Faux Leather
4 3/4" x 6" x 5 3/4" H
(121 x 152 x 146mm)



F4-14 (W, W)
White Faux Leather
6" x 8" x 7 1/8" H
(152 x 203 x 181mm)

Beige Faux Suede Neckform

Beige
Faux Suede
Q-BE



ND202Q -BE
7 5/8" x 6 1/4" x 5 3/4" H
(194 x 160 x 145mm)



ND-1896Q -BE
4" x 3 1/4" x 6 1/4" H
(102 x 83 x 159mm)



ND-1893Q -BE
5" x 4 1/8" x 7 1/2" H
(127 x 105 x 190mm)



ND-1897Q -BE
6 3/8" x 4 1/2" x 10" H
(162 x 114 x 255mm)



ND-1892Q -BE
7 1/2" x 5 1/8" x 11" H
(191 x 130 x 280mm)

Standard Style Neckform

Available Colors

Black
Velvet
(BK)

Black
Faux Leather
L (BK)

White
Faux Leather
L (W)



189-2 (BK)
189-2L (BK)
189-2L (W)

7 1/2" x 5 1/8" x 11" H
(191 x 130 x 280mm)



189-7 (BK)
189-7L (BK)
189-7L (W)

6 3/8" x 4 1/2" x 10" H
(162 x 114 x 255mm)



189-3 (BK)
189-3L (BK)
189-3L (W)

5" x 4 1/8" x 7 1/2" H
(127 x 105 x 190mm)



189-6 (BK)
189-6L (BK)
189-6L (W)

4" x 3 1/4" x 6 1/4" H
(102 x 83 x 160mm)



182-1 (BK)
182-1L (W)

8 1/2" x 3 5/8" x 8 1/2" H
(215 x 92 x 215mm)



182-2 (BK)
182-2L (W)

6 1/2" x 2 3/4" x 6 1/2" H
(165 x 70 x 165mm)



182-3 (BK)
182-3L (W)

4 3/8" x 2 1/2" x 4 1/2" H
(112 x 65 x 114mm)



175-3 (BK)
175-3L (W)

7 1/8" x 6 7/8" x 9 7/8" H
(181 x 175 x 251mm)

Extra Low Profile Neck Display

Fits perfectly inside jewelry display counter

Extra Low Profile Stand



Available Colors

Black Faux Leather L-BK

Black Velvet Y-BK

White Faux Leather L-WH



ND-2211 -Color

8 1/2" W x 7 1/4" x 4 5/8" H
(216 x 184 x 117mm)



ND-2212 -Color

7 5/8" W x 6 1/4" x 3 3/4" H
(194 x 159 x 95mm)



ND-2213 -Color

6 1/8" W x 5 1/4" x 2 3/4" H
(156 x 133 x 70mm)



ND-2214 -Color

5 1/8" W x 4 3/8" x 2 1/2" H
(130 x 111 x 63mm)

Low Profile Neckform

Available Colors

Black Faux Leather L-BK

Black Velvet Y-BK

White Faux Leather L-WH



ND201 -Color

8 1/2" x 7 1/4" x 6 1/2" H
(216 x 184 x 165mm)



ND202 -Color

7 5/8" x 6 1/4" x 5 3/4" H
(194 x 159 x 146mm)



ND203 -Color

6 1/8" x 5 1/4" x 4 3/4" H
(156 x 133 x 121mm)



ND204 -Color

5 1/8" x 4 3/8" x 4" H
(130 x 111 x 102mm)

Neckform Display



ND103L -Color

6 1/2" x 6 1/4" x 5 3/8" H (165 x 160 x 135mm)



ND103Y -Color



ND101L -Color

8 1/8" x 8 1/2" x 6 1/4" H (205 x 215 x 160mm)



ND101Y -Color

Contoured Neckform

Available Colors

NEW



Linen N-LE

NEW



Steel Grey Faux Leather -87R



Black Velvet -BK



White Faux Leather L-WH



ND-1101 -Color
4 3/4" x 3 1/4" x 7 7/8" H
(121 x 82 x 200mm)



ND-1102 -Color
6" x 4" x 11 1/2" H
(152 x 102 x 292mm)

Wide Shoulder Neck Stand



ND-1837 -BK Black Velvet
12" x 6" x 17 1/2" H (305 x 152 x 445mm)

ND-1837L -WH White Faux Leather
(305 x 152 x 445mm)



ND-1834 -BK Black Velvet
7 3/4" x 4 1/4" x 11 1/2" H (197 x 108 x 292mm)

ND-1834L -WH White Faux Leather
(197 x 108 x 292mm)



ND-1832 -BK Black Velvet
5 1/2" x 3" x 8" H (140 x 76 x 203mm)

ND-1832L -WH White Faux Leather
(140 x 76 x 203mm)



Elongated Neckform



182-8 (BK) Black Velvet
6 1/2" x 4 1/8" x 11 7/8" H (165 x 105 x 302mm)

182-8L (W) White Faux Leather
(165 x 105 x 302mm)



182-7 (BK) Black Velvet
5 1/2" x 3 7/8" x 10 3/8" H (140 x 98 x 263mm)

182-7L (W) White Faux Leather
(140 x 98 x 263mm)



182-6 (BK) Black Velvet
4 1/4" x 3 1/2" x 9" H (108 x 89 x 228mm)

182-6L (W) White Faux Leather
(108 x 89 x 228mm)



Neck Stand Display



189-1(BK) Black Velvet
8 3/4" x 6" x 10 5/8" H (222 x 152 x 270mm)

189-1L (W) White Faux Leather
(222 x 152 x 270mm)



189-4L (BK, BK) Black Faux Leather
7 1/2" x 6" x 8" H (191 x 152 x 203mm)

189-4L (W, W) White Faux Leather
(191 x 152 x 203mm)

Combination Neckforms

Available Colors

Black Faux Leather
L (BK)

Black Velvet
(BK)

White Faux Leather
L (W)



189-6A (BK)
189-6AL (BK)
189-6AL (W)
4" x 3 1/4" x 6 1/4" H
(100 x 82 x 160mm)



189-3A (BK)
189-3AL (BK)
189-3AL (W)
5" x 4 1/8" x 7 1/2" H
(127 x 105 x 191mm)



189-7A (BK)
189-7AL (BK)
189-7AL (W)
6 3/8" x 4 1/2" x 10" H
(162 x 114 x 254mm)



189-2A (BK)
189-2AL (BK)
189-2AL (W)
7 1/2" x 5 1/8" x 11" H
(191 x 130 x 279mm)



175-3A (BK)
175-3AL (W)
7 1/8" x 6 7/8" x 9 7/8" H
(181 x 174 x 251mm)



171-3T (BK)
171-3LT (W)
7 1/2" x 6 1/2" x 9" H
(191 x 165 x 229mm)



ND203AY -BK
ND203AL -BK
ND203AL -WH
6 1/8" x 5 1/4" x 5 1/8" H
(155 x 133 x 130mm)



ND204AY -BK
ND204AL -BK
ND204AL -WH
5 1/8" x 4 3/8" x 4 1/4" H
(130 x 111 x 108mm)



181BL (W)
8 1/4" x 6 3/4" x 14 1/2" H
(210 x 171 x 368mm)



181B (BK)

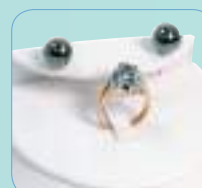

172-2A (BK)
172-2AL (W)
6 1/2" x 7 1/2" x 4" H
(165 x 191 x 102mm)



189-5A (BK)
189-5AL (W)



6" x 5" x 5" H
(152 x 127 x 127mm)

Necklace Collection

122

Combination Neckforms

Available Colors

Black Velvet
(BK)

White Faux Leather
L (W)



189-2B (BK)
189-2BL (W)

7 1/2" x 5 1/8" x 11" H
(191 x 130 x 279mm)



189-7B (BK)
189-7BL (W)

6 3/8" x 4 1/2" x 10" H
(162 x 114 x 254mm)



189-3B (BK)
189-3BL (W)

5" x 4 1/8" x 7 1/2" H
(127 x 105 x 191mm)



ND101BY -BK
ND101BL -WH

8 1/8" x 8 1/2" x 6 1/4" H
(205 x 216 x 159mm)



ND201BY -BK
ND201BL -WH

8 1/2" x 7 1/4" x 6 1/2" H
(216 x 184 x 165mm)



ND202BY -BK
ND202BL -WH

7 5/8" x 6 1/4" x 5 3/4" H
(194 x 159 x 146mm)

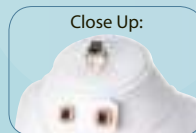

ND203BY -BK
ND203BL -WH

6 1/8" x 5 1/4" x 4 3/4" H
(155 x 133 x 121mm)



175-3BL (W)
175-3B (BK)

7 1/8" x 6 7/8" x 9 7/8" H
(181 x 174 x 251mm)

Necklace Collection

123



189-1B (BK)
189-1BL (W)

8 3/4" x 6" x 10 5/8" H
(222 x 152 x 270mm)



189-4B (BK)
189-4BL (W)

7 1/2" x 6" x 8" H
(191 x 152 x 203mm)



185-2 (BK)
185-2L (W)

7" x 6" x 9 1/4" H
(178 x 152 x 235mm)



185-1 (BK)
185-1L (W)

6 1/2" x 5 1/2" x 8 1/4" H
(165 x 191 x 102mm)

Retractable Neckform

* Made of a durable poly shell. The hide-away stand makes it versatile, easy to store, and easy to travel with. Simply pull down and slide in the back stand to set the display.



Plain

ND-2889 -Color
7" x 6" x 13 1/2" H
(178 x 152 x 343 mm)



Plain

ND-2886 -Color
5 5/8" x 4 1/2" x 8 1/4" H
(143 x 114 x 210mm)

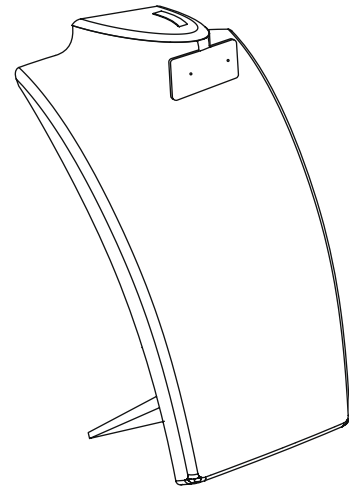

Combination Top

ND-2886C -Color
5 5/8" x 4 1/2" x 8 1/4" H
(143 x 114 x 210mm)

Necklace Collection

124

ND-2889 Hide Away Stand

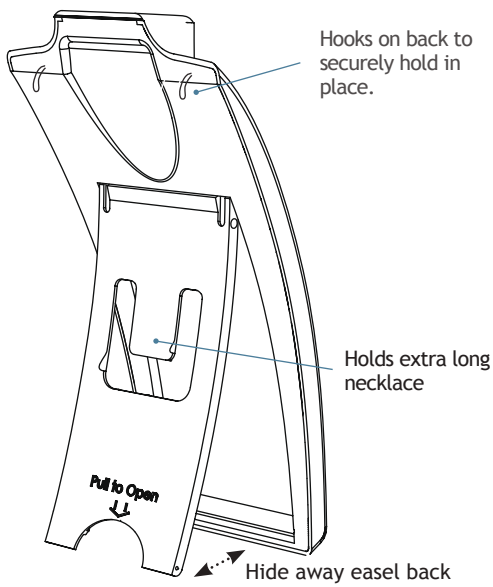

Please see next page for more color options. →



ND-2886 Hide Away Stand

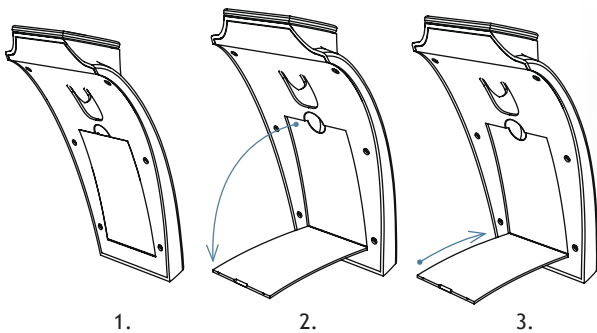

← Available Colors for item ND-2886, ND-2886C, ND-2889



-P10

White matte finish that resists scratches, dirt, and stains



-P20

Black matte finish that resists scratches, dirt, and stains



V-ZP

Zebra / Pink



V-ZR

Zebra / Black



L-WH

White Faux Leather



L-BK

Black Faux Leather



Y-BK

Black Velvet



R-SG

Steel Grey Faux Leather



-N31

Burlap w/Lace



N-LE

Linen Beige



N-N3

Burlap



Q-BE

Beige Faux Suede

Pop-up Necklace Display Bust

6 1/2" x 7 1/2" (165 x 191mm)



ND-2810L -WH
White Bust

ND-2810L -BK
Black Bust

Compact for Storage and Travel

* A bust that can be customized in a way that is simply unmatched. This bust can be adjusted to different heights

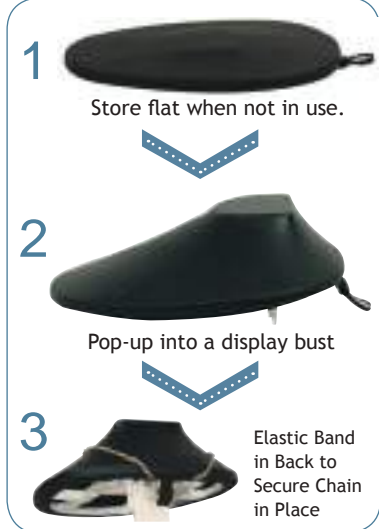
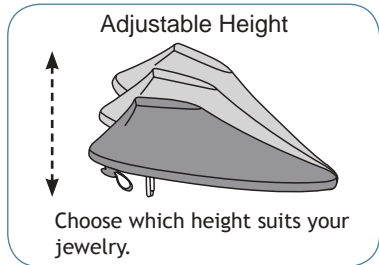

Vacuformed Bust

Lay-Down

173F (BK)
Black Flocked
6 1/4" x 7 1/2" x 3 3/4" H (159 x 191 x 95mm)

173P (BK)
Black Plastic
6 1/4" x 7 1/2" x 3 3/4" H (159 x 191 x 95mm)

Slatwall

173F-3 (BK)
Black Flocked
6 1/4" x 7 1/2" x 3 3/4" H (159 x 191 x 95mm)

173P-3 (BK)
Black Plastic
6 1/4" x 7 1/2" x 3 3/4" H (159 x 191 x 95mm)

Adjustable

173F-1 (BK)
Black Flocked
6 1/4" x 7 1/2" x 7 1/4" H (159 x 191 x 184mm)

173P-1 (BK)
Black Plastic
6 1/4" x 7 1/2" x 7 1/4" H (159 x 191 x 184mm)

Flocked Vacuformed Bust

13F (BK)
5 3/4" x 16" H
(146 x 406mm)

177-1F (BK)
177-1F (P)
6 3/4" x 12" H
(171 x 305mm)

177F (BK)
177F (P)
5 3/4" x 10 1/8" H
(146 x 257mm)

177-2F (BK)
177-2F (P)
4 3/4" x 7 5/8" H
(121 x 194mm)

62-1 (BK)
62-1 (P)
7" x 8" H
(178 x 203mm)

Adjustable Necklace Display

* Adjust both height and viewing angle by turning adjustment knobs to your preference.



7 1/2" x 8" x 5 1/4" ~ 8 7/8" H
(191 x 203 x 133 ~ 225mm)

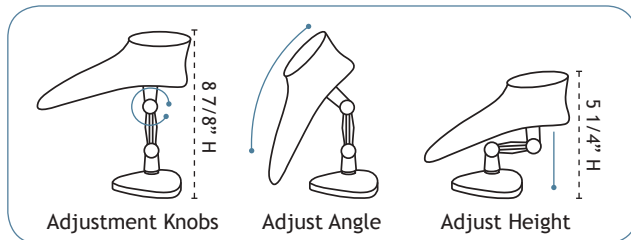

ND-2890N-N3
Burlap



ND-2890L-BK
Black Faux Leather



ND-2890L-WH
White Faux Leather



ND-2890R-SG
Steel Grey Faux Leather

Necklace Collection

127

Lightweight Neckform

* These new contoured lightweight displays weigh a fraction of what other necklace displays do.



ND-2897Y -BK
Black Velvet



ND-2897L -WH
White Faux Leather



ND-2897Q -BE
Beige Faux Suede

6 1/4" x 4 5/8" x 9 1/2" H
(159 x 117 x 241mm)

Standard Neck Displays

Available Colors

Black
Faux Leather
L (BK)

Black
Velvet
(BK)

White
Faux Leather
L (W)



Adjustable Stands



Lay-down Bust

Lay-Down Busts

Small Busts

6 1/2" x 7 1/2" x 4" H
(165 x 191 x 102mm)



172-2 (BK)
Black Velvet



172-2L (W)
White Faux Leather

4 1/2" x 5 1/2" x 3" H (115 x 140 x 75mm)



F4-12 (W, W)
White Faux Leather



F4-12 (BK)
Black Velvet

Large Busts

7 1/2" x 8 1/2" x 3 3/4" H (191 x 216 x 95mm)



172-1 (BK)
Black Velvet



172-1L (BK)
Black Faux Leather



172-1L (W)
White Faux Leather

7" x 8 7/8" x 3 3/4" H (178 x 225 x 95mm)



175-1
Black Velvet



175-1L (BK)
Black Faux Leather



175-1L (W)
White Faux Leather

Adjustable Stand Bust

7" x 8 7/8" x 9 1/2" H (178 x 225 x 241mm)



175-1T
Black Velvet



175-1LT (BK)
Black Faux Leather



175-1LT (W)
White Faux Leather

■ Lay-Down Busts

Small Busts 4 3/4" x 4 5/8" x 2 1/8" H (121 x 117 x 54mm)



171-2L (BK)
Black Faux Leather

171-2L (W)
White Faux Leather

171-2
Black Velvet

Large Busts 6 3/4" x 8" x 3 1/2" H (171 x 203 x 89mm)



171-1L (BK)
Black Faux Leather

171-1L (W)
White Faux Leather

171-1
Black Velvet

■ Lay-Down Busts

Small Busts 5 7/8" x 5 3/8" x 2 3/4" H (149 x 137 x 70mm)



180-3L (BK)
Black Faux Leather

180-3L (W)
White Faux Leather

180-3
Black Velvet

Large Busts 8 1/8" x 7 1/2" x 4 1/2" H (206 x 191 x 108mm)



180-1L (BK)
Black Faux Leather

180-1L (W)
White Faux Leather

180-1
Black Velvet

■ Adjustable Angle Stands

Small Busts 4 3/4" x 4 5/8" x 6" H (121 x 117 x 152mm)



171-2LT (BK)
Black Faux Leather

171-2LT (W)
White Faux Leather

171-2T
Black Velvet

Large Busts 6 3/4" x 8" x 8" H (171 x 203 x 203mm)



171-1LT (BK)
Black Faux Leather

171-1LT (W)
White Faux Leather

171-1T (BK)
Black Velvet

■ Adjustable Angle Stands

Small Busts 5 7/8" x 5 3/8" x 6" H (149 x 137 x 152mm)



180-3LT (BK)
Black Faux Leather

180-3LT (W)
White Faux Leather

180-3T
Black Velvet

Large Busts 8 1/8" x 7 1/2" x 9" H (206 x 191 x 229mm)

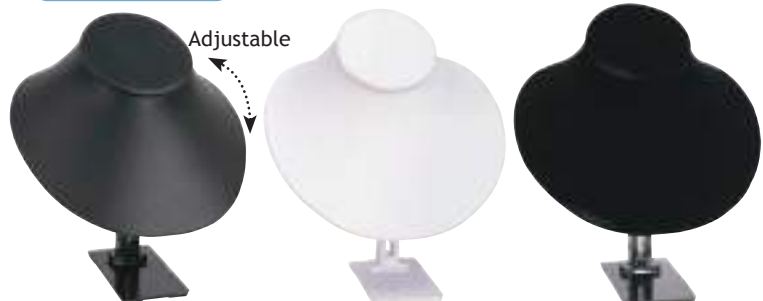

180-1LT (BK)
Black Faux Leather

180-1LT (W)
White Faux Leather

180-1T
Black Velvet

2 1/4" x 3 1/4" x 2 1/2" H
(57 x 82 x 63mm)



F27-8 (RW)
White Faux Leather
w/ Rosewood Trim

2 3/4" x 1 7/8" x 3 1/2" H (70 x 48 x 89mm)



F7-8 (O)
White Faux Leather
w/ Oak Trim



F7-8 (O,BK)
Black Faux Leather
w/ Oak Trim



F7-8 (W)
White Faux Leather



F7-8 (74L)
Beige Faux Suede
w/ Dark Brown Trim

3" x 2" x 4" H (76 x 51 x 102mm)



F7-7 (O,BK)
Black Faux Leather
w/ Oak Trim



F7-7 (RW)
White Faux Leather
w/ Rosewood Trim



F7-7 (BK)
Black Faux Leather



F7-7 (W)
White Faux Leather



F7-7 (74L)
Beige Faux Suede
w/Dark Brown Trim

4 1/8" x 3 3/8" x 5 1/4" H
(105 x 86 x 135mm)



F7-16 (W)
White Faux Leather

4 1/2" x 3 1/4" x 5" H
(114 x 83 x 127mm)



F9-17 (W)
White Faux Leather



F9-17 (BK)
Black Velvet



XD-2917Q -BE
Beige Faux Suede

4" x 4 1/4" x 5 1/4" H
(102 x 108 x 133mm)



F9-16 (W)
White Faux Leather



F9-16 (BK)
Black Velvet

Necklace Collection

130

Storage envelope for extra long chain.

5 1/2" x 2" x 7 1/4" H
(140 x 51 x 184mm)



240-8L (W)
White Faux
Leather

4" x 2" x 5 3/4" H
(102 x 51 x 146mm)



240-8 (BK)
Black Velvet

240-7 (BK)
Black Velvet

240-7L (W)
White Faux
Leather

5 1/2" x 1 7/8" x 8 1/2" H
(140 x 47 x 254mm)



241-9A (BK)
Black Velvet

4" x 1 7/8" x 6 3/4" H
(102 x 47 x 171mm)



241-9B (BK)
Black Velvet

2 3/4" x 2 3/4" x 9 1/8" H
(70 x 70 x 230mm)

BD1713 -BK
Black Velvet



BD1713L -WH
White Faux Leather

3 1/4" x 2" x 4 3/4" H (82 x 51 x 120mm)



XD-2991R-SG Steel Grey Faux Leather
XD-2991-BK Black Velvet
XD-2991L-WH White Faux Leather

3 1/2" x 2 3/4" x 5 1/2" H (89 x 70 x 140mm)

NEW



XD-2992-BK Black Velvet
XD-2992R-SG Steel Grey Faux Leather
XD-2992L-WH White Faux Leather
XD-2992N-N3 Burlap

2 3/4" x 3 1/2" x 12" H (89 x 70 x 305mm)

* Adjustable for optimum viewing angle.

Up to 9 Necklaces



ND199 -BK Black Velvet
ND199L -WH White Faux Leather
ND-1991N -N3 Burlap

4 1/8" x 3" x 9 1/8" H (105 x 76 x 232mm)

* Great combination stand. Sturdy base.



F9-18 (W) White Faux Leather
F9-18 (BK) Black Velvet
XD-2918N-N3 Burlap
XD-2918N-LE Linen

Necklace Collection

131

10" x 1 1/2" x 11 1/2" H (254 x 38 x 292mm)

Up to 6 Necklaces



ND196L -WH White Faux Leather
ND196 -BK Black Velvet

10 3/4" x 4" x 10 1/4" H (272 x 102 x 260mm)

Up to 5 Necklaces



ND100L -WH White Faux Leather
ND100 -BK Black Velvet

5 1/2" x 4 7/8" x 10" H (140 x 124 x 254mm)

ND102 -BK Black Velvet

* The display separates from the base for convenient transport.



ND102R -SG Steel Grey Faux Leather

ND102L -WH White Faux Leather

ND102L -BK Black Faux Leather

Necklace Display with Easel

Available Colors

NEW Burlap N-N3	NEW Linen N-LE
Beige Faux Suede Q-BE	Steel Grey Faux Leather R-SG



Necklace Collection

132



CD-6001R-SG | CD-6001Q-BE
CD-6001N-LE | CD-6001N-N3
8 1/4" W x 12 1/2" H
(210 x 317mm)



CD-6002R-SG | CD-6002Q-BE
CD-6002N-LE | CD-6002N-N3
8 1/4" W x 12 1/2" H
(210 x 317mm)



CD-6703R-SG | CD-6703Q-BE
CD-6703N-LE | CD-6703N-N3
8 5/8" W x 14 1/8" H
(219 x 360mm)



CD-6704R-SG | CD-6704Q-BE
CD-6704N-LE | CD-6704N-N3
7 3/8" W x 8 5/8" H
(187 x 219mm)



CD-6710R-SG | CD-6710Q-BE
CD-6710N-LE | CD-6710N-N3
4 1/4" W x 8 7/8" H
(108 x 225mm)



CD-6702R-SG | CD-6702Q-BE
CD-6702N-LE | CD-6702N-N3
3 3/4" W x 5 1/4" H
(95 x 133mm)



CD-6701R-SG | 9 3/8" W x 9 1/2" H
CD-6701N-LE | (238 x 241mm)
CD-6701Q-BE



CD-6706R-SG | 8 5/8" W x 10 7/8" H
CD-6706N-LE | (219 x 276mm)
CD-6706Q-BE



CD-6712R-SG | 8 1/4" W x 9 1/4" H
CD-6712N-LE | (210 x 235mm)
CD-6712Q-BE



CD-6731R-SG | 2 15/16" W x 3 7/8" H
 CD-6731N-LE | (75 x 98mm)
 CD-6731Q-BE



CD-6732R-SG | 4 1/2" W x 5 1/2" H
 CD-6732N-LE | (113 x 140mm)
 CD-6732Q-BE



CD-6733R-SG | 6 1/2" W x 7 7/8" H
 CD-6733N-LE | (165 x 200mm)
 CD-6733Q-BE



CD-6734R-SG | 8 1/8" W x 11 3/8" H
 CD-6734N-LE | (207 x 289mm)
 CD-6734Q-BE



CD-6739R-SG | 8 1/8" W x 11 3/8" H
 CD-6739N-LE | (207 x 289mm)
 CD-6739Q-BE



CD-6713R-SG | 8 1/2" W x 12 1/2" H
 CD-6713N-LE | (216 x 317mm)
 CD-6713Q-BE



CD-6707R-SG | 4 1/2" W x 5 1/2" H
 CD-6707N-LE | (113 x 140mm)
 CD-6707Q-BE



CD-6708R-SG | 6 1/2" W x 8" H
 CD-6708N-LE | (170 x 203mm)
 CD-6708Q-BE



CD-6709R-SG | 7 5/8" W x 12 1/2" H
 CD-6709N-LE | (195 x 318mm)
 CD-6709Q-BE



CD-6721R-SG | 8" x 3 1/4" x 11 3/4" H
 CD-6721N-LE | (203 x 82 x 279mm)
 CD-6721Q-BE



CD-6722R-SG | 8" x 3 1/4" x 9 1/2" H
 CD-6722N-LE | (203 x 82 x 241mm)
 CD-6722Q-BE



CD-6723R-SG | 9 1/2" x 3 1/4" x 11" H
 CD-6723N-LE | (241 x 82 x 279mm)
 CD-6723Q-BE

Necklace Display with Easel

Available Colors

Black Faux Leather L (BK)	White Faux Leather L (WH)
Black Velvet (BK)	Grey Velvet (G)



Necklace Collection

134



60-1L (BK)
60-1L (W)
60-1 (BK)
60-1 (G)

8 1/4" W x 12 1/2" H (210 x 317mm)



60-2L (BK)
60-2L (W)
60-2 (BK)
60-2 (G)

8 1/4" W x 12 1/2" H (210 x 317mm)



67-3L (BK)
67-3L (W)
67-3 (BK)
67-3 (G)

8 5/8" W x 14 1/8" H (219 x 360mm)



67-1L (W)
67-1 (BK)

9 3/8" W x 9 1/2" H (238 x 241mm)



CD-6712L -WH
CD-6712V -BK

8 1/4" W x 9 1/4" H (210 x 235mm)



67-2L (BK)
67-2L (W)
67-2 (BK)
67-2 (G)

3 3/4" W x 5 1/4" H (95 x 133mm)



67-4L (BK)
67-4L (W)
67-4 (BK)
67-4 (G)

7 3/8" W x 8 5/8" H (187 x 219mm)



67-6L (BK)
67-6L (W)
67-6 (BK)
67-6 (G)

8 5/8" W x 10 7/8" H (219 x 276mm)



67-KL (BK)
67-KL (W)
67-K (BK)
67-K (G)

4 1/4" W x 8 7/8" H (108 x 225mm)



67-A3L (W)
67-A3 (BK)

6 1/2" W x 7 7/8" H (165 x 200mm)



67-A2L (W)
67-A2 (BK)

4 1/2" W x 5 1/2" H (113 x 140mm)



67-A1L (W)
67-A1 (BK)

2 15/16" W x 3 7/8" H (75 x 98mm)



CD-6713L (W)
CD-6713V (BK)

8 1/2" W x 12 1/2" H (216 x 317mm)



67-A9L (W)
67-A9 (BK)

8 1/8" W x 11 3/8" H (207 x 289mm)



67-A4L (W)
67-A4 (BK)

8 1/8" W x 11 3/8" H (207 x 289mm)



67-9L (W)
67-9 (BK)

7 5/8" W x 12 1/2" H (195 x 318mm)



67-8L (W)
67-8 (BK)

6 1/2" W x 8" H (170 x 203mm)



67-7L (W)
67-7 (BK)

4 1/2" W x 5 1/2" H (113 x 140mm)



191-3L (W)
191-3 (BK)

9 1/2" x 3 1/4" x 11" H (241 x 82 x 279mm)



191-2L (W)
191-2 (BK)

8" x 3 1/4" x 9 1/2" H (203 x 82 x 241mm)



191-1L (W)
191-1 (BK)

8" x 3 1/4" x 11 3/4" H (203 x 82 x 298mm)

Available Colors

Black Faux Leather L (BK)

Black Velvet (BK)

White Faux Leather L (W)



Fits in standard full size tray.

Chain Display Board



Cover Top

15 Snaps

CD653L -WH
CD653V -BK

9 3/4" W x 17 7/8" H
(248 x 454mm)



6 Snaps

93S-1 (BK)

7 5/8" W x 14 1/8" H
(195 x 360mm)



6 Snaps

93L-1 (W)
93

7 5/8" W x 14 1/8" H
(195 x 360mm)



Cover Top

18 Hooks

CD652L -WH
CD652V -BK

9 1/2" W x 13 7/8" H
(242 x 352mm)



32 Hooks

68-BL (BK)
68-BL (W)
68-B (BK)

7 5/8" W x 14 1/8" H
(195 x 360mm)



26 Hooks

68-CL (BK)
68-CL (W)
68-C (BK)

14 1/8" W x 7 5/8" H
(360 x 195mm)

Necklace Collection

136

Flocked Plastic Stand with Easel

Available Colors for
61-1, 64-1, & 65-1

Flocked Black (BK)

Flocked White (W)

Flocked Grey (G)



With Easel

61-1 (BK)
61-1 (W)
61-1 (G)

9 1/4" W x 9 1/2" H
(235 x 240mm)



With Easel

64-1 (BK)
64-1 (W)
64-1 (G)

7 1/2" W x 14 1/8" H
(190 x 360mm)



With Easel

65-1 (BK)
65-1 (W)
65-1 (G)

11 1/2" W x 12 3/4" H
(292 x 324mm)

Flocked Cardboard Stand with Easel



62-1R (BK)

8 1/8" W x 8 7/8" H
(206 x 225mm)



61-1R (BK)
61-1R (R)

9 1/4" W x 9 1/2" H
(235 x 240mm)



64-1R (BK)
64-1R (R)

7 1/2" W x 14 1/8" H
(190 x 360mm)

Combination Display



255R (BK)

9 1/8" W x 10 1/2" H
(228 x 267mm)

■ Beige Faux Suede Necklace Easel Stand

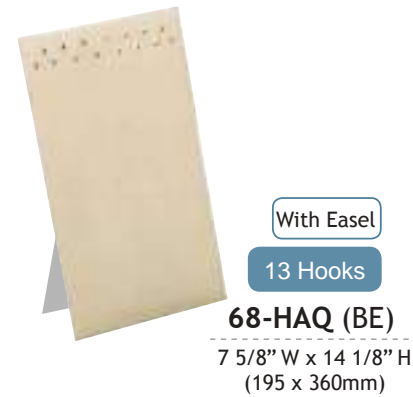
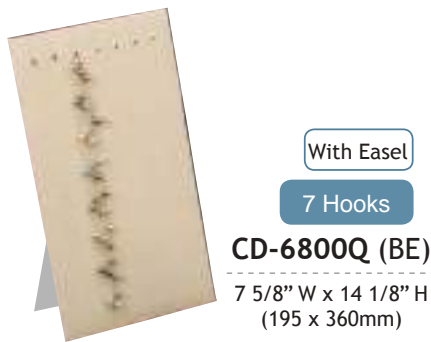

■ Necklace Easel Stand

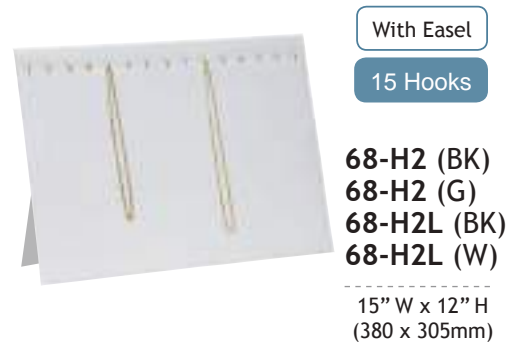
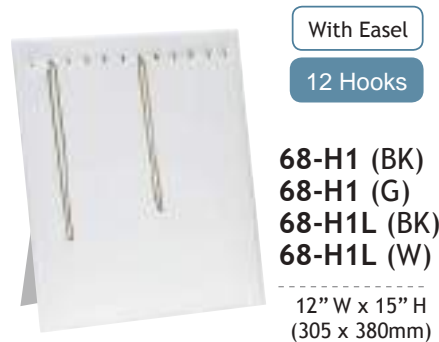
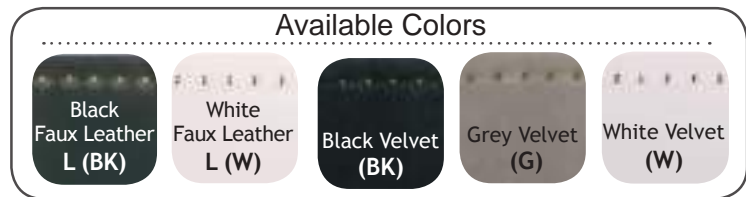

Modern Necklace Display

* These modern necklace displays lay flat for easy transport and space saving. It converts easily into an attractive display cone.

7 1/4" x 8 1/2" x 4 7/8" H (184 x 216 x 124mm)



NC-1021L-WH
White Faux Leather



NC-1021V-BK
Black Velvet



NC-1021Q-BE
Beige Faux Suede



NC-1021N-LE
Beige Linen



NC-1021N-N3
Burlap

Versatile Burlap Stand

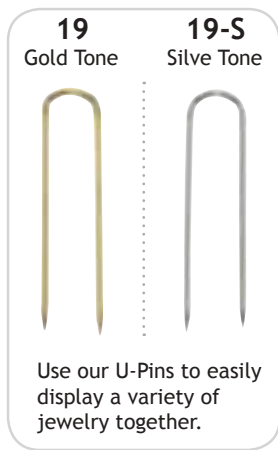

ED-2249N -N3
8" x 4" x 9"H
(203 x 102 x 228mm)

Foldable Plastic Neckforms



NC-1001 -BK
Black
8 3/8" x 3 1/2" x 8 1/8" H (213 x 89 x 206mm)



NC-1001 -WH
White

Combination Flocked Foldable Neckform

* Display a necklace, ring and a pair of earrings.
* This lightweight material makes these neck forms great for travel.



NC-1013-BK
NC-1013-WH
7" x 5 1/2" x 12" H
(178 x 140 x 305mm)



NC-1012-BK
NC-1012-WH
6" x 5" x 9 1/2" H
(152 x 127 x 241mm)



NC-1011-BK
NC-1011-WH
4 1/4" x 4" x 7 1/2" H
(108 x 102 x 191mm)

■ Burlap Slatwall Display NEW

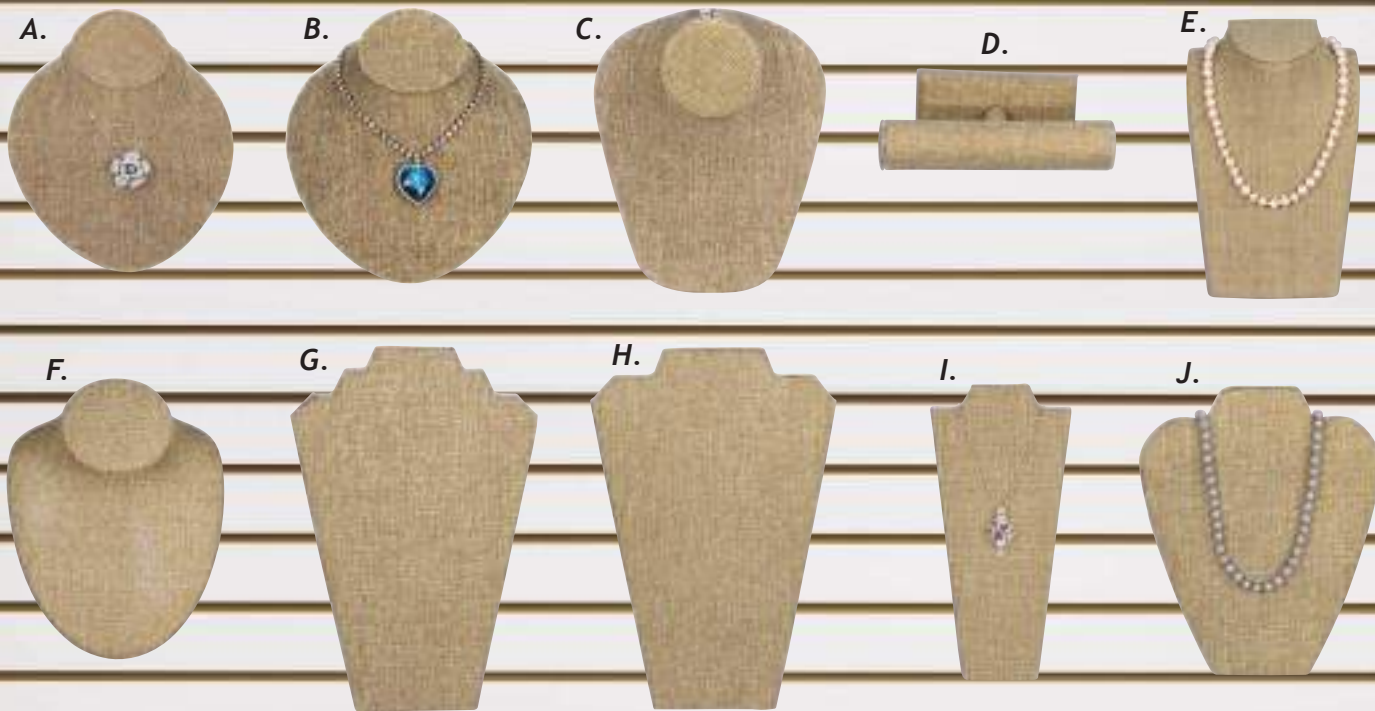

■ Linen Slatwall Display NEW

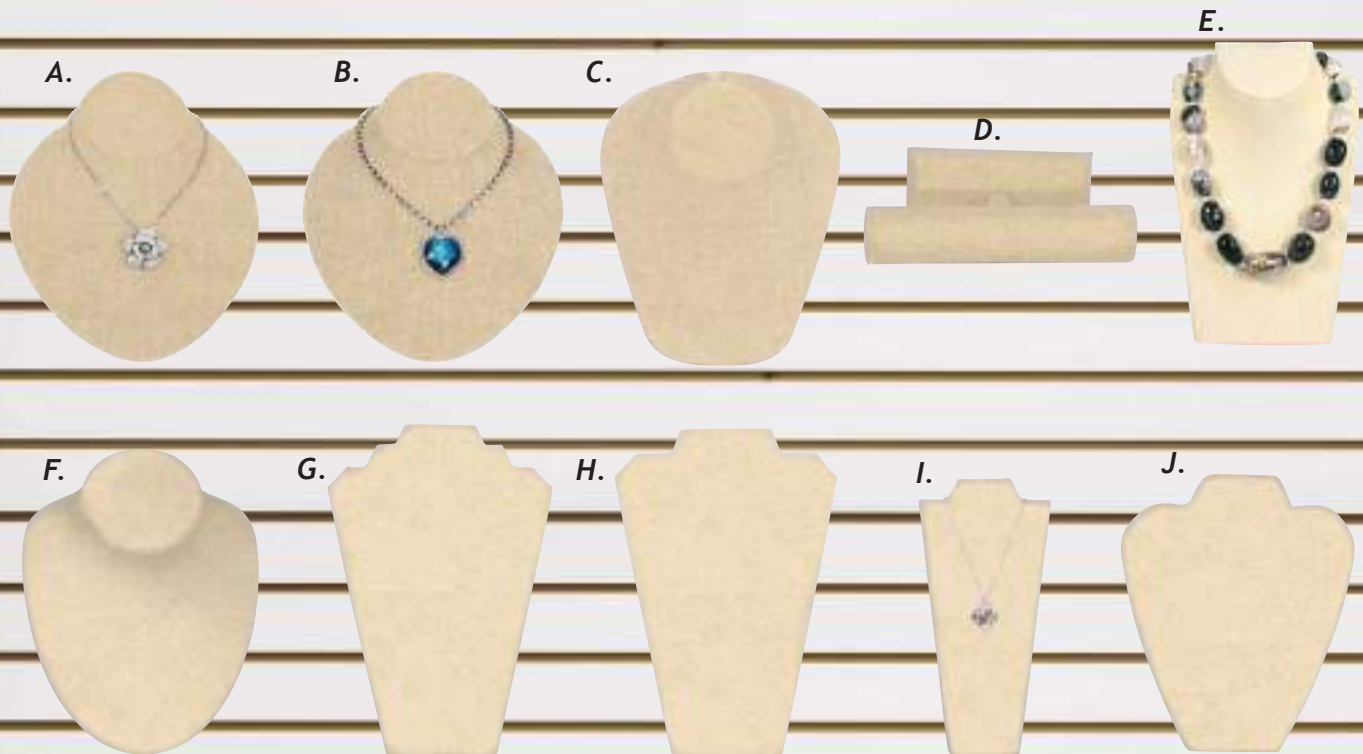

Slatwall Collection

139

	Burlap	Beige Linen	Size: W x D x H	(mm)		Burlap	Beige Linen	Size: W x D x H	(mm)
A.	SD-1711N-N3	SD-1711N-LE	6 3/4" x 8"	(171 x 203)	F.	SD-2890N-N3	SD-2890N-LE	7 1/2" x 8"	(191 x 203)
B.	SD-1721N-N3	SD-1721N-LE	7 1/2" x 8 1/2"	(191 x 216)	G.	SD-6001N-N3	SD-6001N-LE	8 1/4" x 12 1/2"	(210 x 317)
C.	SD-1751N-N3	SD-1751N-LE	7" x 8 7/8"	(178 x 225)	H.	SD-6002N-N3	SD-6002N-LE	8 1/4" x 12 1/2"	(210 x 317)
D.	SD-2111N-N3	SD-2111N-LE	7 1/2" x 5"	(191 x 127)	I.	SD-6710N-N3	SD-6710N-LE	4 1/4" x 8 7/8"	(108 x 225)
E.	SD-2886N-N3	SD-2886N-LE	5 5/8" x 8 1/4"	(143 x 210)	J.	SD-6704N-N3	SD-6704N-LE	7 3/8" x 8 5/8"	(187 x 219)

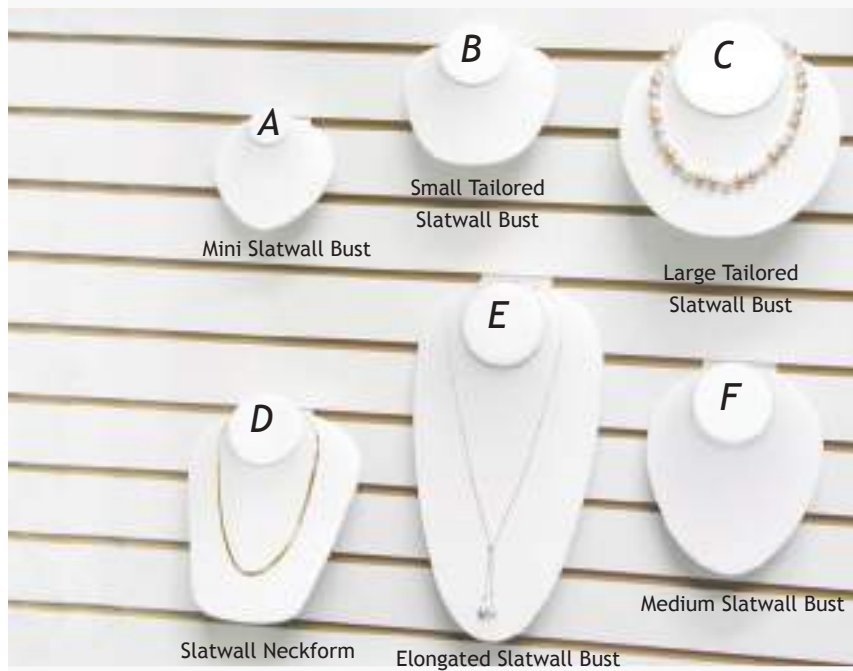

Available Colors

Black Faux Leather LS (BK)	White Faux Leather LS (W)	Black Velvet S (BK)
----------------------------	---------------------------	---------------------

Neckforms

	Faux Leather	Black Velvet	Size: W x H	(mm)
A.	171-2LS (Color)	171-2S (BK)	4 3/4" x 4 5/8"	(121 x 117)
B.	180-3LS (Color)	180-3S (BK)	5 3/4" x 5 3/8"	(149 x 136)
C.	180-1LS (Color)	180-1S (BK)	8 1/8" x 7 1/2"	(206 x 191)
D.	175-1LS (Color)	175-1S (BK)	7" x 8 7/8"	(178 x 225)
E.	181-1LS (Color)	181-1S (BK)	8 1/4" x 15"	(210 x 380)
F.	171-1LS (Color)	171-1S (BK)	6 3/4" x 8"	(171 x 203)

Slatwall Collection

140

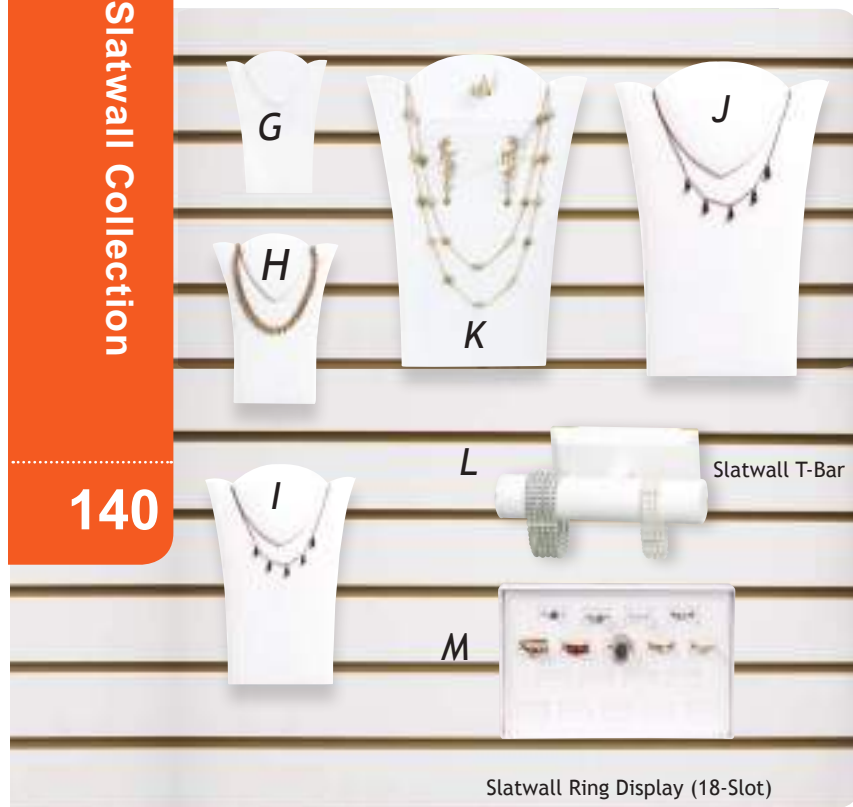

Necklace Boards

	White Faux Leather	Black Velvet	Size: W x H	(mm)
G.	SD-6731L -WH	SD-6731 -BK	2 7/8" x 3 7/8"	(75 x 98)
H.	SD-6732L -WH	SD-6732 -BK	4 1/2" x 5 1/2"	(113 x 13)
I.	SD-6733L -WH	SD-6733 -BK	6 1/2" x 7 7/8"	(165 x 200)
J.	SD-6734L -WH	SD-6734 -BK	8 1/8" x 11 3/8"	(207 x 289)
K.	SD-6739L -WH	SD-6739 -BK	8 1/8" x 11 3/8"	(207 x 289)

Tray & T-Bar

	Faux Leather	Black Velvet	Size: W x H	(mm)
L.	219LS (Color)	219S (BK)	7 1/2" x 4 7/8"	(191 x 124)
M.	RD-9618LS - Color		9 7/8" x 5 7/8"	(250 x 150)

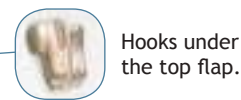

18-Hook Chain Boards

	Faux Leather	Black Velvet	Size: W x H	(mm)
N.	CD652LS -Color	CD652VS -BK	9 1/2" x 13 7/8"	(242 x 351)



Item T and U for body jewelry display.

Available Colors

Black Velvet
-BK

White Faux Leather
L-WH

Neckforms & Boards

	White Faux Leather	Black Velvet	Size: W x H	(mm)
A.	SD-6001L -WH	SD-6001 -BK	8 1/4" x 12 1/2"	(210 x 317)
B.	SD-6002L -WH	SD-6002 -BK	8 1/4" x 12 1/2"	(210 x 317)
C.	SD-6700L -WH	SD-6700 -BK	5" x 8"	(127 x 203)
D.	SD-6702L -WH	SD-6702 -BK	3 3/4" x 5 1/4"	(95 x 133)
E.	SD-6703L -WH	SD-6703 -BK	8 5/8" x 14 1/8"	(219 x 360)
F.	SD-6704L -WH	SD-6704 -BK	7 3/8" x 8 5/8"	(187 x 219)
G.	SD-6706L -WH	SD-6706 -BK	8 5/8" x 10 7/8"	(219 x 276)
H.	SD-6707L -WH	SD-6707 -BK	4 1/2" x 5 1/2"	(115 x 140)
I.	SD-6708L -WH	SD-6708 -BK	6 1/2" x 8"	(170 x 200)
J.	SD-6709L -WH	SD-6709 -BK	7 5/8" x 12 1/2"	(195 x 318)
K.	SD-6710L -WH	SD-6710 -BK	4 1/4" x 8 7/8"	(108 x 225)
L.	SD-6721L -WH	SD-6721 -BK	8" x 11 3/4"	(203 x 298)
M.	SD-6722L -WH	SD-6722 -BK	8" x 9 1/2"	(203 x 241)
N.	SD-6723L -WH	SD-6723 -BK	9 1/2" x 11"	(241 x 279)
O.	SD-6800L -WH	SD-6800 -BK	7 5/8" x 14 1/8"	(195 x 360)
P.	SD-6801L -WH	SD-6801 -BK	12" X 15"	(305 x 380)
Q.	SD-6802L -WH	SD-6802 -BK	15" X 12"	(380 x 305)
R.	SD-6811L -WH	SD-6811 -BK	12" x 15"	(305 x 380)
S.	SD-6812L -WH	SD-6812 -BK	15" x 12"	(380 x 305)
T.	SD-6831L -WH	SD-6831 -BK	14 1/8" x 7 5/8"	(360 x 195)
U.	SD-6836L -WH	SD-6836 -BK	11 1/2" x 16 1/4"	(295 x 412)

NEW



Half Moon Bracelet Display

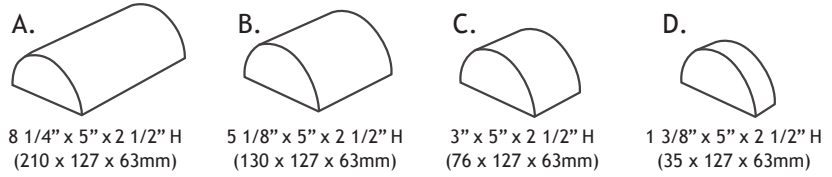

	Steel Grey Faux Leather	Linen	Beige Faux Suede	Burlap w/ Lace
A.	BD-2300R-SG	BD-2300N-LE	BD-2300Q-BE	BD-2300-N31
B.	BD-2302R-SG	BD-2302N-LE	BD-2302Q-BE	BD-2302-N31
C.	BD-2304R-SG	BD-2304N-LE	BD-2304Q-BE	BD-2304-N31
D.	BD-2306R-SG	BD-2306N-LE	BD-2306Q-BE	BD-2306-N31



Pillow Displays

NEW

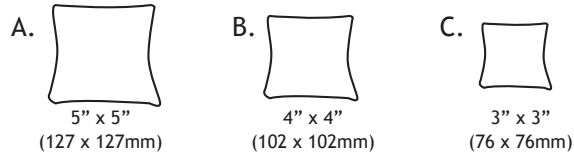

	Burlap	Steel Grey Faux Leather	Beige Linen	White Faux Leather	Black Faux Leather	Black Velvet
A.	11-1N-N3	11-1R (SG)	11-1N (LE)	11-1L (W)	11-1L (BK)	11-1 (BK)
B.	11-2N-N3	11-2R (SG)	11-2N (LE)	11-2L (W)	11-2L (BK)	11-2 (BK)
C.	11-3N-N3	11-3R (SG)	11-3N (LE)	11-3L (W)	11-3L (BK)	11-3 (BK)

Bracelet Ramp

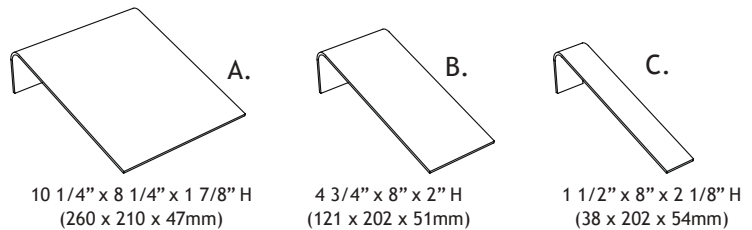

	Burlap	Beige Linen	Steel Grey Faux Leather
A.	BD-1237N-N3	BD-1237N-LE	BD-1237R-SG
B.	BD-1238N-N3	BD-1238N-LE	BD-1238R-SG
C.	BD-1239N-N3	BD-1239N-LE	BD-1239R-SG



■ Jewelry Roll w/Zipper Pouch



3" Dia. x 11 3/4" L (76 Dia. x 300mm)



74 (BK)
Black Velvet

74N-N3
Burlap

■ Double Tube Tray

* All white faux leather with removable tubes.



BT-1202L-WH
7 7/8" x 8" x 3 1/4" H
(200 x 205 x 82 mm)

■ Wood Trim Half Moon Ramp

1 7/8" x 6" x 2 1/2" H (47 x 152 x 63mm)



F27-6 (RW)
Rosewood
w/ White Faux Leather



F27-6 -N3
Natural Wood w/ Burlap



F27-6 -DW,LE
Dark Walnut w/ Linen



F27-6 -87R
Black Faux Leather w/
Steel Grey Faux Leather



F27-6 -75L
Dark Brown Faux Leather w/
Chestnut Faux Suede

■ Slotted Tray

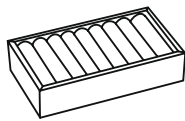

9 Slot

210 - Color
7 1/2" x 4 1/4" x 1 3/8" H
(191 x 108 x 35mm)



Steel Grey Faux Leather
w/ Black Trim
-87R

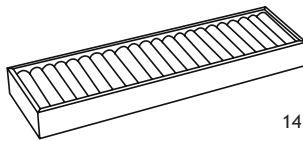

21 Slot

211 - Color
14 3/4" x 4 1/4" x 1 1/2" H
(375 x 108 x 38mm)



Beige Linen
N (LE)



Burlap w/ Lace
-N31

■ Rosewood Trim Display



BD1703L -RW
8" x 4 1/4" x 3 3/4" H
(205 x 108 x 95mm)



DWB8 -RW
9" x 1 1/8" x 7/8" H
(228 x 30 x 23mm)



230L (RW)
8 1/4" x 5" x 2 1/2" H
(210 x 127 x 63mm)



F7-1 (RW)
8 1/8" x 1 5/8" x 1 3/8" H
(205 x 40 x 35mm)



JK-623 -RW
8 1/4" x 2 1/8" x 1 3/4" H
(210 x 54 x 44mm)



F33-6 (RW)
7 1/2" x 1 1/8" x 1 1/4" H
(190 x 27 x 33mm)

Bracelet Tube w/Stand
8" x 4 1/2" x 3 3/4" H (205 x 108 x 95mm)



BD1703L -WH
All White Faux Leather

BD1703R -87R
Steel Grey Faux Leather

NEW

Fringe Pillow Displays

White Faux Leather



11-4L
3 3/4" Dia.
(95mm)

11-5L
2 3/4" Dia.
(70mm)

11-8L
2 1/2" x 4 1/2"
(63 x 114mm)

11-9L
2 1/2" x 3 1/2"
(63 x 90mm)

Use w/ u-pin

Contour Bracelet Displays

* This display is designed for easy pinning.

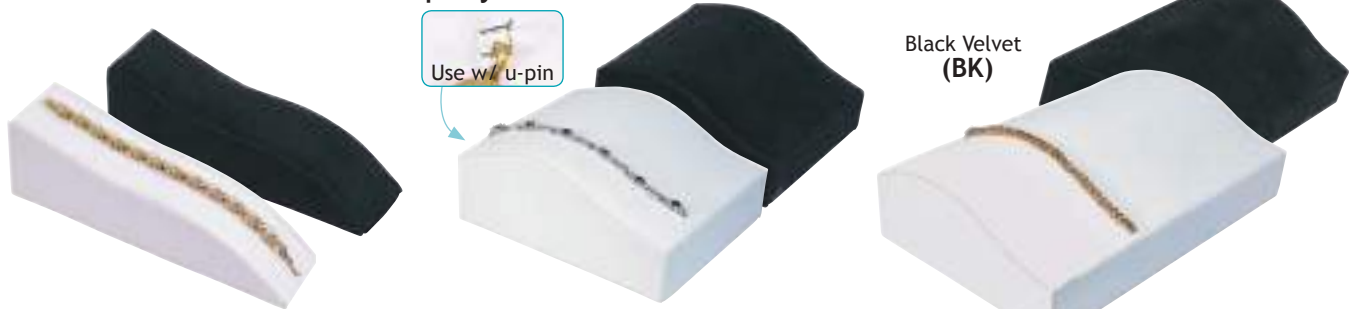

230-15 (Color)
2" x 6 1/8" x 2 1/2" H
(51 x 156 x 63mm)

230-11 (Color)
5 1/8" x 6 1/8" x 2 1/2" H
(130 x 156 x 63mm)

Black Velvet
(BK)

White
Faux Leather
L (W)

230-12 (Color)
10" x 6 1/8" x 2 1/2" H
(254 x 156 x 63mm)

Use w/ u-pin

Bracelet Collection

144

Acrylic Holder

Pillow not included.



1112
Acrylic Stand
2 1/4" H (57mm)

Low Profile Bracelet Display

8 1/8" x 1 5/8" x 1 3/8" H (205 x 40 x 35mm)



NEW

F4-1 (W, BK)
White Faux Leather
with Black Trim

F4-1 (87R)
Steel Grey Faux Leather
with Black Trim

F4-1 (W, W)
White Faux Leather

Tubes with Carrying Case

- * Case with center divider for protection.
- * 2 removable tubes included.



WC-102L -BK
Faux Leather
10" x 4 1/2" x 3 1/2" H
(254 x 114 x 89mm)

Bangle Stands

White Faux
Leather
L-WH

Black Velvet
-BK



BD7214L -Color
Large Stand
14" x 2 1/2" x 2 1/4" H
(356 x 63 x 57mm)

BD7207L -Color
Small Stand
7 3/4" x 2 1/2" x 2 1/8" H
(197 x 63 x 54mm)

Half Moon Display



230 (Color)
8 1/4" x 5" x 2 1/2" H
(210 x 127 x 63mm)



230-2 (Color)
5 1/8" x 5" x 2 1/2" H
(130 x 127 x 63mm)



230-4 (Color)
3" x 5" x 2 1/2" H
(76 x 127 x 63mm)



230-6 (Color)
1 3/8" x 5" x 2 1/2" H
(35 x 127 x 63mm)



231F (BK)
8 1/8" x 6 1/8" x 2" H
(206 x 156 x 51mm)



231-1F (BK)
7 5/8" x 2" x 1 3/4" H
(194 x 50 x 44mm)

Available Colors



White
Faux Leather
L (W)

Black
Faux Leather
L (BK)

Black
Velvet
(BK)

Slotted Trays



Black
Leatherette

White Faux
Leather

Black Velvet

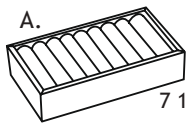

9 Slot

7 1/2" x 4 1/4" x 1 3/8" H
(191 x 108 x 35mm)

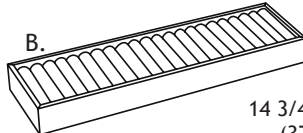

21 Slot

14 3/4" x 4 1/4" x 1 1/2" H
(375 x 108 x 38mm)

Style	Black Leatherette w/ Black Velvet	White Faux Leather	Black Velvet
A. 9 Slots	210-A	210L (W)	210 (BK)
B. 21 Slots	211-A	211L (W)	211 (BK)

Bangle Stand

4 3/4" x 3" x 1 1/2" H
(120 x 75 x 35mm)

4010 (BK)
Black Velvet



4010L (W)
White Faux Leather

Bangle Display Cases

16 Slot



210-B
7 3/4" x 4 1/4" x 3 5/8" H
(197 x 108 x 92mm)

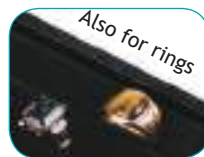

Also for rings

38 Slot



211-B
14 5/8" x 4 1/4" x 3 1/2" H
(372 x 108 x 90mm)

* Opens into two display trays.

* Case can be taken apart to make two separate trays.

* Black leatherette wood case with black velvet insert.

Bracelet Ramp Displays

Available Colors

Black
Faux Leather
L (BK)

White
Faux Leather
L (W)

Black
Velvet
(BK)

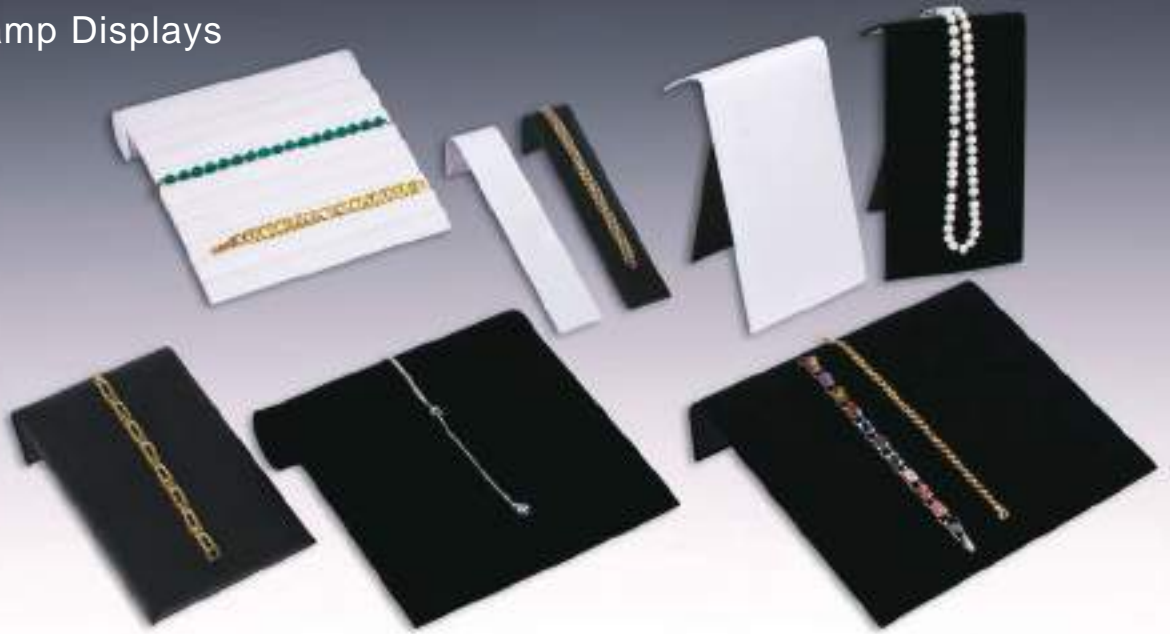

Bracelet Collection

Bracelet Ramp



239L (BK)
239L (W)
239 (BK)

1 1/2" x 8" x 2 1/8" H
(38 x 202 x 54mm)



239-2L (BK)
239-2L (W)
239-2 (BK)

4 3/4" x 8" x 2" H
(121 x 202 x 51mm)



239-1L (BK)
239-1L (W)
239-1 (BK)

10 1/4" x 8 1/4" x 1 7/8" H
(260 x 210 x 47mm)



221-CL (BK)
221-CL (W)
221-CV (BK)

8" x 8 1/2" x 1 3/4" H
(204 x 215 x 44mm)

With Easel



239-4L (W)
239-4 (BK)

4 3/4" x 5" x 7 3/8" H
(121 x 127 x 187mm)

With Easel



239-3L (W)
239-3 (BK)

10 1/4" x 5" x 7 3/8" H
(260 x 127 x 187mm)

Slotted Bracelet Ramp

7 Slot



221-AL (W)
221-AV (BK)

11" x 7 1/8" x 1 3/4" H
(279 x 181 x 44mm)

9 Slot



221-BL (W)
221-BV (BK)

8" x 8 3/4" x 1 3/4" H
(202 x 222 x 44mm)

18-Slotted Tray Insert

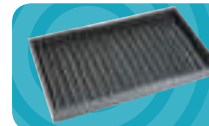

Slotted tray insert can fit in our standard size tray.



221L (BK)
221L (W)
221 (BK)

14 1/8" x 7 5/8" H
(360 x 195mm)

■ Black Velvet Bars w/ Wire Base



F-1113 (BK)
12 1/8" x 6 1/2" x 12" H
(308 x 165 x 305mm)



F-1112 (BK)
12 1/8" x 6 1/2" x 7 5/8" H
(308 x 165 x 194mm)



F-1111 (BK)
12 1/8" x 4 1/2" x 6 1/2" H
(308 x 114 x 165mm)

■ Multi-Bar Displays 12 1/8" x 9 1/2" x 10 3/4" H (308 x 241 x 273mm)



216-1BL (W)
White Faux Leather



216-1B (BK)
Black Velvet

* Disassemble for storage.

This multi-bar display is perfect for displaying on the go. It disassembles and stores flat making it ideal for transportation. Display many bracelets or bangles at once while using only a fraction of your valuable counter space.

■ Vertical Bracelet Display

4 5/8" x 4 5/8" x 13" H
(117 x 117 x 330mm)

* This display will show off many bracelets at a time while only taking up a small fraction of the space.



BD-2701V -BK
Black Velvet

BD-2701L -WH
White Faux Leather

BD-2701N -N3
Burlap

BD-2701L -BK
Black Faux Leather

BD-2701N -LE
Linen

BD-2701R -SG
Steel Grey Faux Leather

■ 360° Spinning Display

Available Colors

Black Faux Leather L (BK) White Faux Leather L (W)



BD-2706L -Color
11 3/8" x 13" H
(290 x 330mm)

Bracelet Collection

147

Beige and Steel Grey T-Bars



T-Bar Collection

148

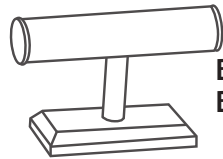

BD-2111Q -BE
BD-2111R -SG
7 1/2" x 5" H
(190 x 127mm)

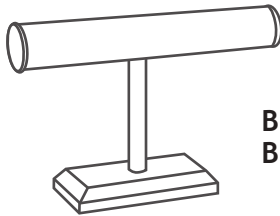

BD-2112Q -BE
BD-2112R -SG
12" x 6 3/4" H
(305 x 170mm)

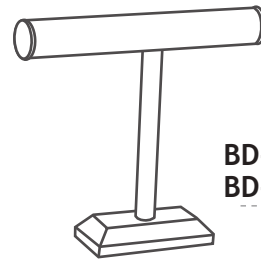

BD-2113Q -BE
BD-2113R -SG
12" x 12" H
(305 x 305mm)

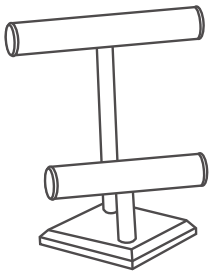

BD-2123Q -BE
BD-2123R -SG
9 3/8" x 10 7/8" H
(238 x 276mm)

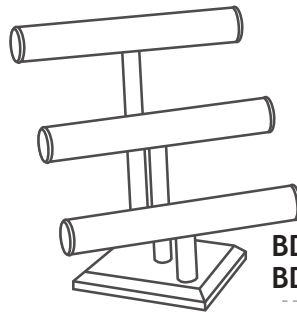

BD-2132Q -BE
BD-2132R -SG
12" x 12 3/4" H
(305 x 324mm)

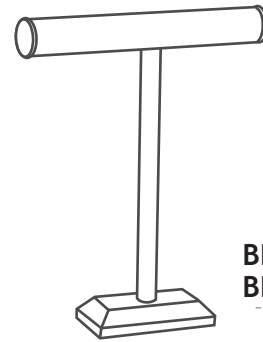

BD-2114Q -BE
BD-2114R -SG
14" x 18 1/8" H
(355 x 460mm)

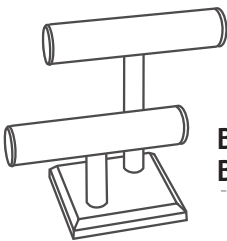

BD-2181Q -BE
BD-2181R -SG
10 1/2" x 8 1/4" H
(267 x 210mm)

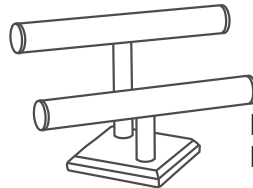

BD-2122Q -BE
BD-2122R -SG
12" x 8" H
(305 x 203mm)

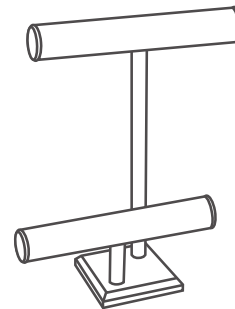

BD-2124Q -BE
BD-2124R -SG
14 3/4" x 16" H
(375 x 406mm)

Oval Bar



BD-2201Q -BE
4 1/8" x 4 3/8" H
(105 x 111mm)

Oval Bar

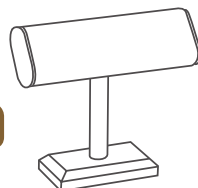

BD-2211Q -BE
BD-2211R -SG 7 1/2" x 6 1/2" H
(191 x 165mm)

Oval Bar

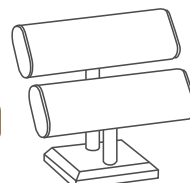

BD-2221Q -BE
BD-2221R -SG 7 3/8" x 7 1/8" H
(187 x 180mm)

Oval Bar

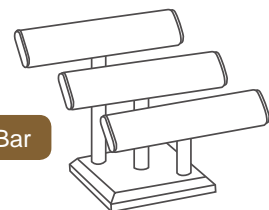

BD-2231Q -BE
BD-2231R -SG 10 1/4" x 10 1/4" H
(260 x 260mm)

■ Linen and Burlap T-Bars



Available Colors

Linen
N-LE

Burlap
N-N3



T-Bar Collection

149

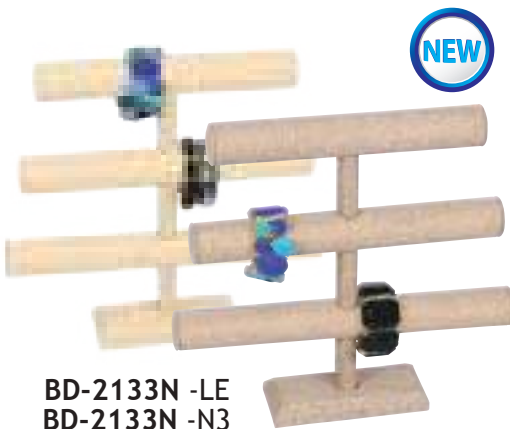

NEW

BD-2133N -LE
BD-2133N -N3

14" x 3 1/2" x 13" H
(356 x 89 x 330mm)



NEW

BD-2132N -LE
BD-2132N -N3

12" x 12 3/4" H
(305 x 324mm)



NEW

BD-2123N -LE
BD-2123N -N3

9 3/8" x 10 7/8" H
(238 x 276mm)



NEW

Oval Bar

BD-2211N -LE
BD-2211N -N3

7 1/2" x 6 1/2" H
(191 x 165mm)



NEW

Oval Bar

BD-2221N -LE

7 3/8" x 7 1/8" H
(187 x 180mm)



NEW

BD-2181N -N3

10 1/2" x 8 1/4" H
(267 x 210mm)

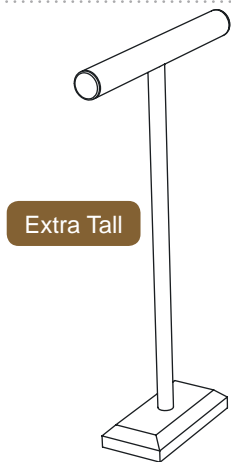

Extra Tall

BD-2116N -LE
BD-2116N -N3

14" W x 24" H
(356 x 610mm)

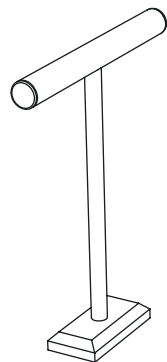

BD-2114N -LE
BD-2114N -N3

14" x 18 1/8" H
(355 x 460mm)

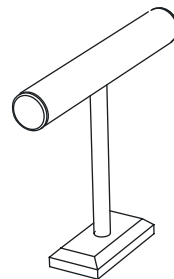

BD-2113N -LE
BD-2113N -N3

12" x 12" H
(305 x 305mm)

NEW

Available Colors

Burlap
N-N3

Linen
N-LE

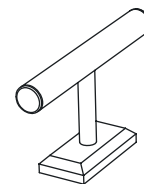

BD-2112N -LE
BD-2112N -N3

12" x 6 3/4" H
(305 x 170mm)

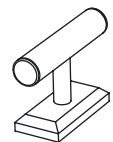

BD-2111N -LE
BD-2111N -N3

7 1/2" x 5" H
(190 x 127mm)

Oval Shape T-Bar



Available Colors

Black Velvet
(BK)

Black
Faux Leather
L (BK)

White
Faux Leather
L (W)



T-Bar Collection

150



Round Bar

BD-2161 -BK
BD-2161L -WH

15 1/2" x 7" x 6 1/2" H
(394 x 178 x 165 mm)



Oval Bar

BD-2261 -BK
BD-2261L -WH

15 1/2" x 7" x 6 1/2" H
(394 x 178 x 165 mm)



219-2A (BK)
219-2AL (BK)
219-2AL (W)

7 1/2" x 6 1/2" H
(191 x 165mm)



219-3A (BK)
219-3AL (W)

12" x 5 3/8" H
(305 x 135mm)



Round Bar

BD1601 -BK
BD1601L -WH

6 1/4" x 11 1/2" H
(159 x 292mm)



219-4A (BK)
219-4AL (W)

12" x 10" H
(305 x 254mm)



218-2A (BK)
218-2AL (BK)
218-2AL (W)

7 3/8" x 7 1/8" H
(187 x 180mm)



218-6A (BK)
218-6AL (W)

12" x 9 3/4" H
(305 x 248mm)



218-3A (BK)
218-3AL (W)

10 1/4" x 10 1/4" H
(260 x 260mm)



218-4A (BK)
218-4AL (W)

12 5/8" x 13" H
(320 x 330mm)



218-5A (BK)
218-5AL (W)

12" x 15 1/4" H
(305 x 387mm)

Available Colors

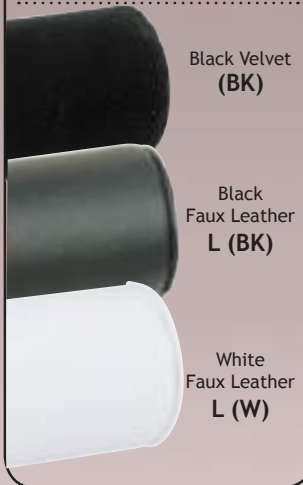

Black Velvet (BK)

Black Faux Leather L (BK)

White Faux Leather L (W)

Round Shape T-Bar



NEW

Extra Tall

T-Bar Collection

151



219 (BK)
219L (BK)
219L (W)
7 1/2" x 5" H
(190 x 127mm)



219-1A (BK)
219-1AL (BK)
219-1AL (W)
12" x 6 3/4" H
(305 x 170mm)



218-1B (BK)
218-1BL (BK)
218-1BL (W)
14 3/4" x 16" H
(375 x 406mm)



219-1C (BK)
219-1CL (BK)
219-1CL (W)
14" x 18 1/8" H
(355 x 460mm)



219-1B (BK)
219-1BL (BK)
219-1BL (W)
12" x 12" H
(305 x 305mm)



218 (BK)
218L (BK)
218L (W)
9 3/8" x 10 7/8" H
(238 x 276mm)



218-1A (BK)
218-1AL (BK)
218-1AL (W)
10 1/2" x 8 1/4" H
(267 x 210mm)



216 (BK)
216L (BK)
216L (W)
12" x 12 3/4" H
(305 x 324mm)



216-4A (BK)
216-4AL (W)
12" x 19 3/4" H
(305 x 502mm)



216-4B (BK)
216-4BL (BK)
216-4BL (W)
12" x 11 1/2" H
(305 x 292mm)



216-5A (BK)
216-5AL (BK)
216-5AL (W)
12" x 13 3/4" H
(305 x 349mm)

■ Bracelet T-Bar

7 1/8" x 2 3/4" x 7 1/8" H (182 x 70 x 18 cm)

Wood Trim



BD-0552 -N3
Burlap w/
Natural Wood Trim



BD-0552 -DW, LE
Linen w/
Dark Walnut Trim



BD-0552 -RW
White Faux Leather w/
Rosewood Trim

Faux Leather Trim



BD-0552 -87R
Steel Grey Faux leather
w/ Black Trim



BD-0552 -BK, G
Grey Suede
w/ Black Trim



BD-0552 -75L
Chestnut Faux Suede w/
Brown Faux Leather Trim



BD-0552 -74L
Beige Faux Suede w/
Brown Faux Leather Trim

■ Rosewood Trim T-Bar

152



219L (RW)
7 1/2" x 5" H
(190 x 127mm)

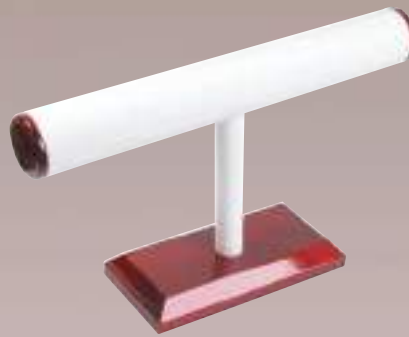

219-1AL (RW)
12" x 7" H
(305 x 178mm)



219-1BL (RW)
12" x 12" H
(305 x 305mm)



JK-624 -RW
7 1/2" x 6" H
(190 x 152mm)



F42-7 (RW)
7 1/4" x 5 1/2" H
(184 x 140 mm)



BD1703L -RW
8" x 4 1/4" x 3 3/4" H
(205 x 108 x 95mm)

T-Bar Collection

■ Metal T-Bar Collection



251-137 -BK
10" x 5" x 14 7/8" H
(254 x 127 x 378mm)



251-132 -BK
8" x 2 3/4" x 6" H
(203 x 70 x 152mm)



251-135 -BK
11 1/2" x 5 1/2" x 9 1/2" H
(292 x 127 x 241mm)



Adjustable height

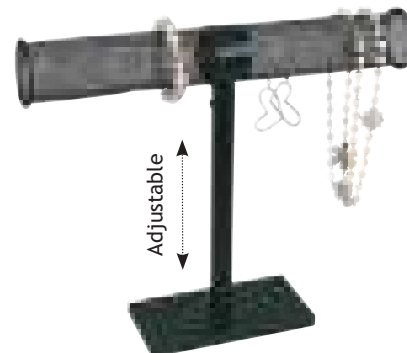

251-133 -BK
14 1/4" x 3 3/8" x 16 1/2" H
(362 x 86 x 419mm)

■ Economic T-bar Display

* Made of sturdy long lasting materials.



BD-3111 -BK
Black Velour
7 1/8" x 5" H (180 x 127 mm)



BD-3112 -BK
Black Velour

12" x 5" H (305 x 127 mm)



BD-3112N -N3
Burlap



■ Zebra T-Bar Display



BD-2114V -ZP
Zebra Pink Velvet

BD-2111V -ZP
Zebra Pink Velvet

BD-2111V -ZR
Zebra Black Velvet

7 1/2" x 5" H
(190 x 127 mm)

BD-2114V -ZR
Zebra Black Velvet

14" x 18 1/8" H
(355 x 460 mm)

■ Burlap w/ Lace T-Bar Display



BD-2111 -N31
7 1/2" x 5" H
(190 x 127 mm)



BD-2221 -N31
7 3/8" x 7 1/8" H
(187 x 180 mm)



■ Fancy Black Metal Displays

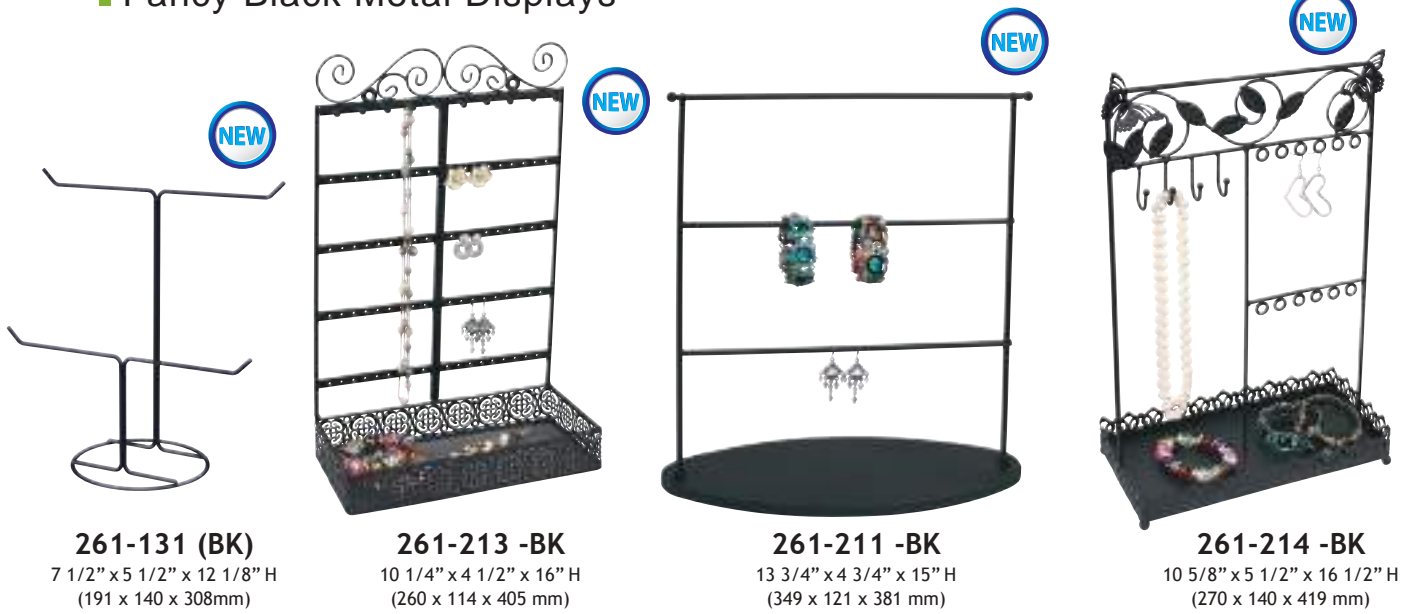

261-131 (BK)

7 1/2" x 5 1/2" x 12 1/8" H
(191 x 140 x 308mm)

261-213 -BK

10 1/4" x 4 1/2" x 16" H
(260 x 114 x 405 mm)

261-211 -BK

13 3/4" x 4 3/4" x 15" H
(349 x 121 x 381 mm)

261-214 -BK

10 5/8" x 5 1/2" x 16 1/2" H
(270 x 140 x 419 mm)

■ Black Wire Neckform Stand

9 1/2 x 13 3/4 (241 x 349mm)



251-181-M20

Diamond Pattern

251-182-M20

Honeycomb Pattern

251-183-M20

Abstract Pattern

■ Metal Earring Bar Displays



251-220 (BK)

Up to 20-Pr. Earrings
6 1/4" x 4" x 14 3/8" H
(159 x 102 x 365mm)

251-250 (BK)

Up to 50-Pr. Earrings
11 3/4" x 4" x 17 5/8" H
(298 x 102 x 448mm)

251-350 (BK)

Up to 50-Pr. Earrings
13" x 4" x 17 5/8" H
(330 x 102 x 448mm)

■ Metal Displays



261-116 (Color)
10" x 5 1/8" x 16" H
(254 x 130 x 406mm)



261-104 (Color)
Up to 40-Pr. Earrings
11" x 5 1/8" x 15" H
(279 x 130 x 381mm)



261-102 (Color)
Up to 16-Pr. Earrings
9" x 3 1/2" x 8" H
(228 x 89 x 203mm)



261-101 (Color)
Up to 5-Pr. Earrings
5 1/2" x 3 1/2" x 4 1/2" H
(140 x 89 x 114mm)

Available Colors



Black (BK)



Copper (CP)



261-119 (Color)
Up to 15 Bracelets/
Necklaces
8 1/2" x 14" H
(216 x 356mm)



261-118 (Color)
12-Arm Spinning Rack
8 1/8" x 14 3/4" H
(205 x 375mm)



261-117 (Color)
11" x 7" x 15 1/4" H
(279 x 178 x 387mm)



261-112 (Color)
8" x 7" x 15" H
(203 x 178 x 381mm)



261-111 (Color)
6 1/2" x 5 1/8" x 10" H
(165 x 130 x 254mm)

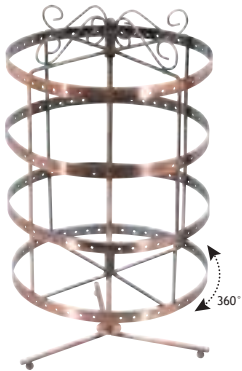

261-296 (Color)
Up to 96-Pr. Earrings
7 3/4" Dia. x 14 1/8" H
(197 Dia. x 359mm)

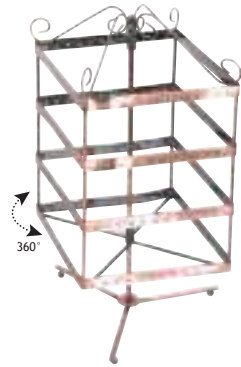

261-196 (Color)
Up to 96-Pr. Earrings
6 1/2" x 6 1/2" x 14" H
(165 x 165 x 356mm)

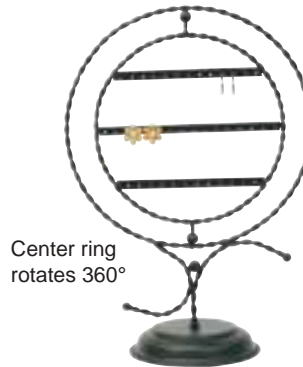

Center ring rotates 360°
261-127 (Color)
Up to 20-Pr. Earrings
10 3/4" x 6" x 15 1/4" H
(273 x 152 x 387mm)

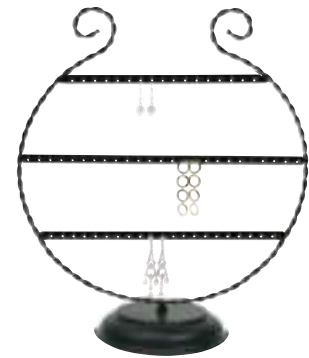

261-128 (Color)
Up to 30-Pr. Earrings
12 3/4" x 6" x 14 3/4" H
(324 x 152 x 375mm)



261-230 (Color)
Up to 56-Pr. Earrings
8 1/2" x 5" x 15" H
(216 x 127 x 381mm)

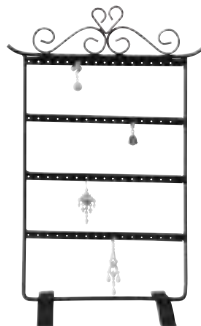

261-232 (Color)
Up to 32-Pr. Earrings
10" x 15 1/4" H
(254 x 387mm)



261-233 (Color)
Up to 36-Pr. Earrings
13 7/8" x 14 3/4" H
(352 x 375mm)



261-234 (Color)
Up to 18-Pr. Earrings/
10 Necklaces
13 7/8" x 14 3/4" H
(352 x 375mm)

Available Colors

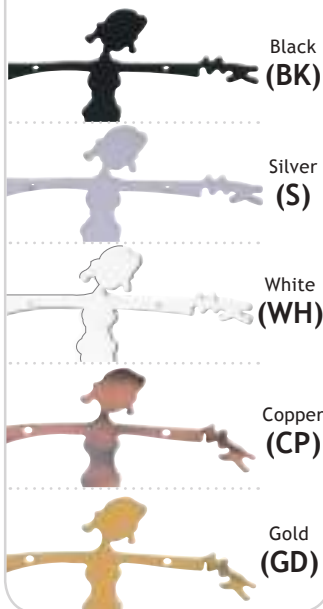

■ Mini Metal Display



251-113 (Color)

2 3/8" x 2 1/2" H
(60 x 63mm)

251-114 (Color)

5 5/8" x 4" H
(143 x 102mm)



251-111 (Color)

3 3/8" x 3 1/4" H
(86 x 82mm)

251-112 (Color)

4 3/4" x 4 5/8" H
(121 x 117mm)

■ Earring Stand



Angel



Up to 10-Pr. Earrings

ES2

6 3/4" x 7" (171 x 178mm)

Earring Collection

■ Music Metal Displays



251-121 (BK)
251-121 (CP)

Up to 7-Pr. Earrings

5 1/8" x 2 1/4" x 4 1/2" H
(130 x 57 x 114mm)



251-123 (BK)
251-123 (CP)

Up to 7-Pr. Earrings

7 5/8" x 2 5/8" x 6 1/8" H
(194 x 67 x 156mm)



251-124 (BK)
251-124 (CP)

Up to 1-Pr. Earring

5 3/4" x 1 5/8" x 4" H
(146 x 41 x 102mm)



251-125 (BK)
251-125 (CP)

Up to 39-Pr. Earrings

11" x 5 1/8" x 13 1/4" H
(279 x 130 x 337mm)



251-126 (BK)
251-126 (CP)

Multiple Earrings

10" x 5 1/8" x 13 5/8" H
(254 x 130 x 346mm)

156

■ Spinner Rack



261-396 (BK)
261-396 (CP)

Up to 120-Pr. Earrings

11 3/4" x 11 3/4" x 18" H
(298 x 298 x 457mm)

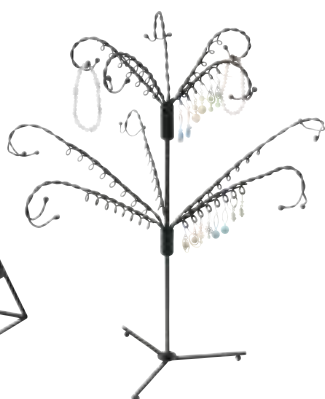

261-126 (BK)
261-126 (CP)

Up to 35-Pr. Earrings

16" x 16" x 17 1/2" H
(406 x 406 x 445mm)

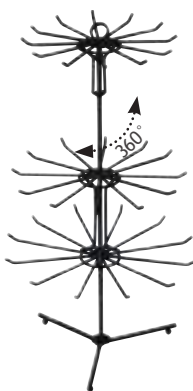

261-123 (BK)
261-123 (CP)

36 Bars

9 1/2" x 9 1/2" x 17 1/4" H
(241 x 241 x 438mm)



Copper (CP)

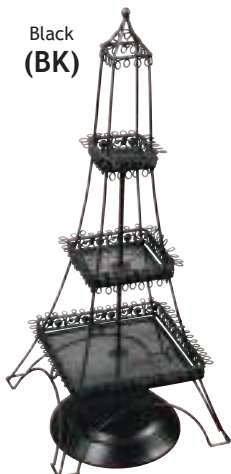

Black (BK)

261-395 (BK)
261-395 (CP)

Up to 90-Pr. Earring

8 1/4" x 8 1/4" x 21" H
(210 x 210 x 533mm)

Multi-Earring Displays

Available Colors

White
Faux Leather
L (W)

Black
Faux Leather
L (BK)

Grey Velvet
(G)

Black Velvet
(BK)



224L (BK)
224L (W)
224 (BK)
224 (G)

Up to 20-Pr. Earrings
7" x 2" x 2 1/2" H
(178 x 51 x 63mm)

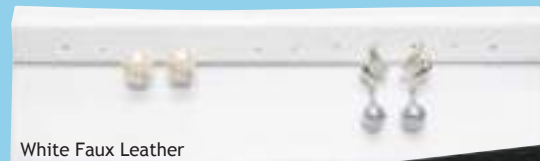

White Faux Leather



Black Velvet

223 (BK)
223L (W)

Up to 6-Pr. Earrings
10" x 1 3/4" x 2 3/4" H
(254 x 44 x 70mm)



214-6
214-6L (W)

Up to 3-Pr. Earrings
6" x 1 5/8" x 2 3/4" H
(152 x 41 x 70mm)



214-7
214-7L (W)

Up to 6-Pr. Earrings
12" x 1 5/8" x 2 5/8" H
(305 x 41 x 67mm)



214-9 (BK)
214-9L (W)

1-Pr. Earring
2 3/8" x 2" x 4 1/2" H
(60 x 50 x 115mm)



214-8 (BK)
214-8L (W)

Up to 6-Pr. Earrings
7 5/8" x 2" x 4 1/2" H
(195 x 50 x 115mm)



ED-2248N-N3

Burlap
7 5/8" x 2" x 4 1/2" H
(195 x 50 x 115mm)



Earring Ramp



238
238L (W)

Up to 5-Pr. Earrings
1 3/8" x 6 1/4" x 2" H
(35 x 159 x 51mm)



238-2 (BK)
238-2L (W)

Up to 12-Pr. Earrings
1 5/8" x 8" x 2" H
(41 x 203 x 51mm)

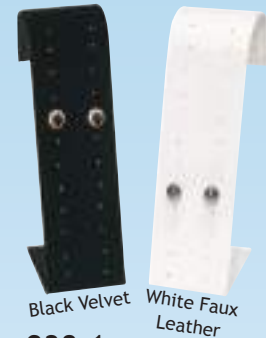

238-1
238-1L (W)

Up to 12-Pr. Earrings
2" x 2 7/8" x 6 5/8" H
(51 x 73 x 168mm)

■ Combination Earring Displays

2 3/4" x 2" x 4" H (70 x 50 x 102mm)

NEW



ED-0461L -BK
Black Faux Leather



ED-0461L -WH
White Faux Leather



ED-0461N -LE
Linen



ED-0461V -BK
Black Velvet



ED-0461 -87R
Steel Grey Faux Leather w/
Black Trim

■ Multi-Function Display Stands

NEW



ED-2249N -N3
Burlap
8" x 4" x 9" H
(203 x 102 x 228mm)

19 Gold Tone
19-S Silver Tone

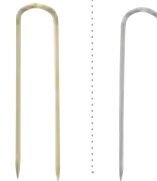

Use our U-Pins to easily display a variety of jewelry pieces together. U-Pin sold separately.



NEW **ED-2248N-N3**
Burlap
7 5/8" x 2" x 4 1/2" H
(195 x 50 x 115mm)

Earring Collection

158

■ Linen and Burlap Earring Displays

NEW



ED-2140N -LE
ED-2140N -N3

2 3/8" x 1 1/2" x 3" H
(60 x 38 x 76mm)

NEW



ED-2293N -LE
ED-2293N -N3

1 1/2" x 2 1/8" x 3 1/4" H
(38 x 54 x 82mm)

NEW



ED-2298N -LE
ED-2298N -N3

4" x 1 1/2" x 2 1/4" H
(102 x 38 x 57mm)

NEW



ED-2225N -LE
ED-2225N -N3

2 3/8" x 1 1/2" x 3 3/8" H
(60 x 38 x 86mm)

NEW



Back pocket
for easy
storage

ED-2143N -LE
ED-2143N -N3

2 1/2" x 1 3/4" x 3 1/4" H
(65 x 44 x 82mm)

NEW



Back pocket
for easy
storage

ED-2144N -LE
ED-2144N -N3

3 1/2" x 1 3/4" x 4 1/4" H
(89 x 44 x 114mm)

Velvet/Faux Leather Earring Stand Collections

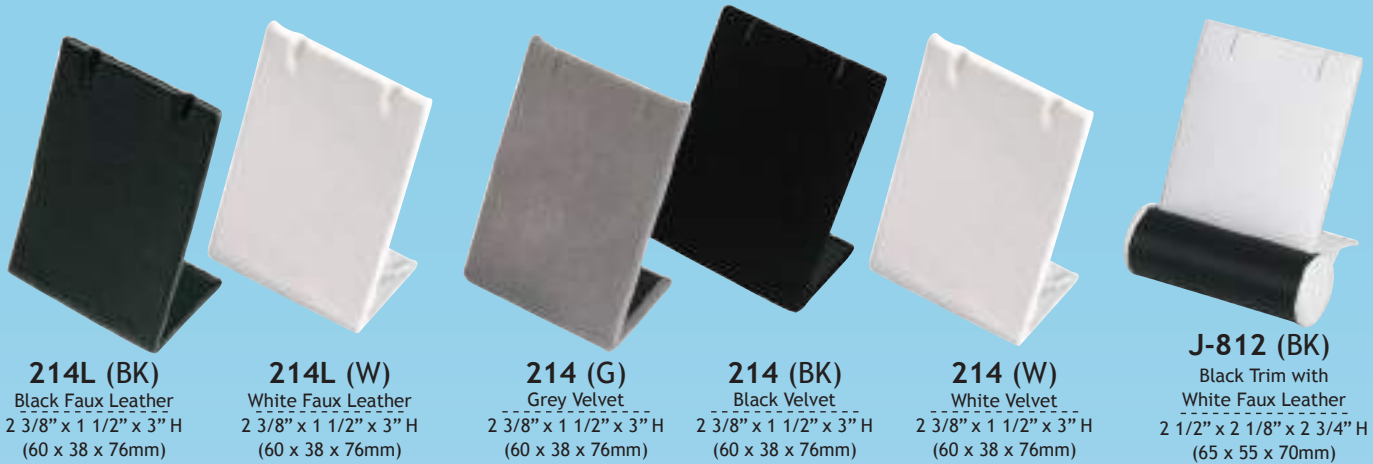

214L (BK)

Black Faux Leather
2 3/8" x 1 1/2" x 3" H
(60 x 38 x 76mm)

214L (W)

White Faux Leather
2 3/8" x 1 1/2" x 3" H
(60 x 38 x 76mm)

214 (G)

Grey Velvet
2 3/8" x 1 1/2" x 3" H
(60 x 38 x 76mm)

214 (BK)

Black Velvet
2 3/8" x 1 1/2" x 3" H
(60 x 38 x 76mm)

214 (W)

White Velvet
2 3/8" x 1 1/2" x 3" H
(60 x 38 x 76mm)

J-812 (BK)

Black Trim with
White Faux Leather
2 1/2" x 2 1/8" x 2 3/4" H
(65 x 55 x 70mm)



225 (BK)

Black Velvet
2 3/8" x 1 1/2" x 3 3/8" H (60 x 38 x 86mm)

225L (W)

White Faux Leather
2 3/8" x 1 1/2" x 3 3/8" H (60 x 38 x 86mm)

XD-225 -BK

Black Velvet
2 3/8" x 1 1/2" x 3 3/8" H (60 x 38 x 86mm)

XD-225L -WH

White Faux Leather
2 3/8" x 1 1/2" x 3 3/8" H (60 x 38 x 86mm)

214-1 (BK)

Black Velvet
2 3/8" x 2" x 3 5/8" H (60 x 51 x 92mm)

214-1L (W)

White Faux Leather
2 3/8" x 2" x 3 5/8" H (60 x 51 x 92mm)



214-3

Black Velvet
2 1/2" x 1 3/4" x 3 1/4" H (65 x 44 x 82mm)

214-3L (W)

White Faux Leather
2 1/2" x 1 3/4" x 3 1/4" H (65 x 44 x 82mm)

ED-2144V -BK

Black Velvet
3 1/2" x 1 3/4" x 4 1/4" H (89 x 44 x 114mm)

ED-2144L -WH

White Faux Leather
3 1/2" x 1 3/4" x 4 1/4" H (89 x 44 x 114mm)

227 (BK)

Black Velvet
3 1/8" x 1 7/8" x 4 1/2" H (79 x 47 x 114mm)

227L (W)

White Faux Leather
3 1/8" x 1 7/8" x 4 1/2" H (79 x 47 x 114mm)

Curved Top Earring Stands



Available Colors



Black Velvet
(BK)



White
Faux Leather
L (W)

	Black Velvet	White Faux Leather	Size: W x D x H	(mm)
A.	229-3 (BK)	229-3L (W)	1 1/2" x 2 1/8" x 3 1/4"	(38 x 54 x 82)
B.	229-4 (BK)	229-4L (W)	1 1/2" x 1 1/2" x 2 1/4"	(38 x 38 x 57)
C.	229-5 (BK)	229-5L (W)	2" x 2 1/8" x 3 1/4"	(51 x 54 x 82)
D.	229-6 (BK)	229-6L (W)	2" x 1 1/2" x 2 1/4"	(51 x 38 x 57)
E.	229-7 (BK)	229-7L (W)	4" x 2 1/8" x 2 7/8"	(102 x 54 x 73)
F.	229-8 (BK)	229-8L (W)	4" x 1 1/2" x 2 1/4"	(102 x 38 x 57)

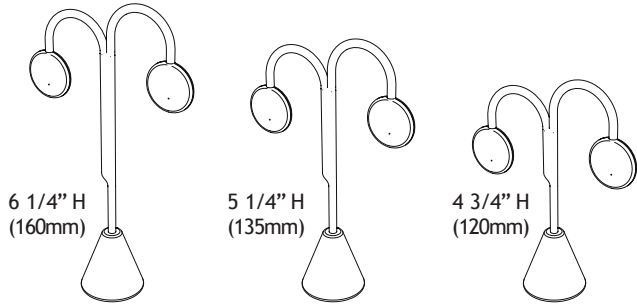

ED-2413 -Color ED-2411 -Color ED-2412 -Color

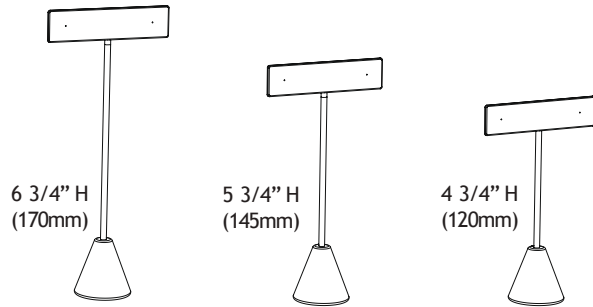

ED-2401 -Color ED-2402 -Color ED-2403 -Color



Fan Shaped Earring Stands

Up to 2-Pr. Earring



ED-2421V -BK Black Velvet
ED-2421Q -BE Beige Faux Suede
ED-2421L -WH White Faux Leather

Earring Stands w/Ring Clip

Up to 2-Pr. Earring with Ring Clip



XD-2422Q -BE Beige Faux Suede
XD-2422L -WH White Faux Leather
XD-2422V -BK Black Velvet

Twirl Earring Stands



ED-2381V -BK Black Velvet
ED-2381Q -BE Beige Faux Suede
ED-2381L -WH White Faux Leather

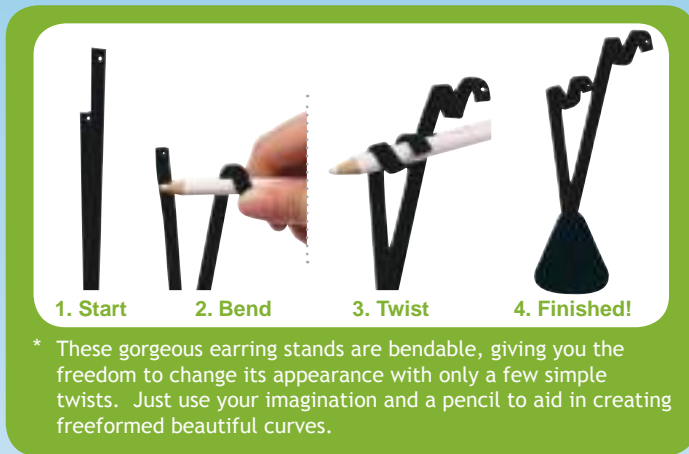

* These gorgeous earring stands are bendable, giving you the freedom to change its appearance with only a few simple twists. Just use your imagination and a pencil to aid in creating freeformed beautiful curves.

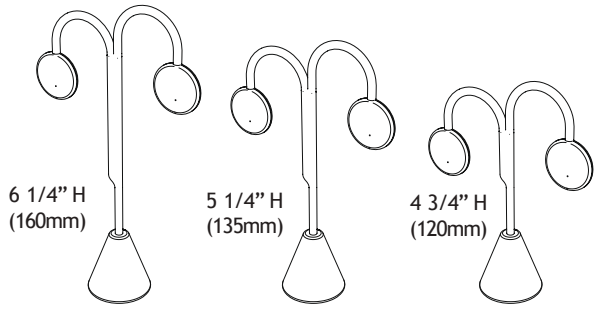

ED-2413 -Color ED-2411 -Color ED-2412 -Color



Available Colors

NEW

NEW

Burlap
N-N3

Beige Linen
N-LE

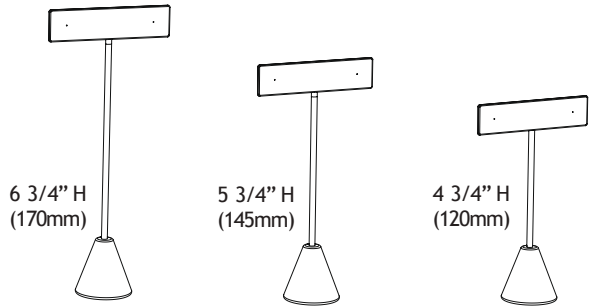

ED-2401 -Color ED-2402 -Color ED-2403 -Color



Available Colors

NEW

NEW

Burlap
N-N3

Beige Linen
N-LE

■ Beige Faux Suede, and Steel Grey Earring Displays



ED-2140R -SG
ED-2140Q -BE

2 3/8" x 1 1/2" x 3" H
(60 x 38 x 76mm)



ED-2225R -SG
ED-2225Q -BE

2 3/8" x 1 1/2" x 3 3/8" H
(60 x 38 x 86mm)



ED-2293R -SG
ED-2293Q -BE

1 1/2" x 2 1/8" x 3 1/4" H
(38 x 54 x 82mm)

NEW



ED-2144R -SG

3 1/2" x 1 3/4" x 4 1/4" H
(89 x 44 x 114mm)

Back pocket for
easy storage



ED-2143R -SG
ED-2143Q -BE

2 1/2" x 1 3/4" x 3 1/4" H
(65 x 44 x 82mm)

■ Fan Style Earring Stand

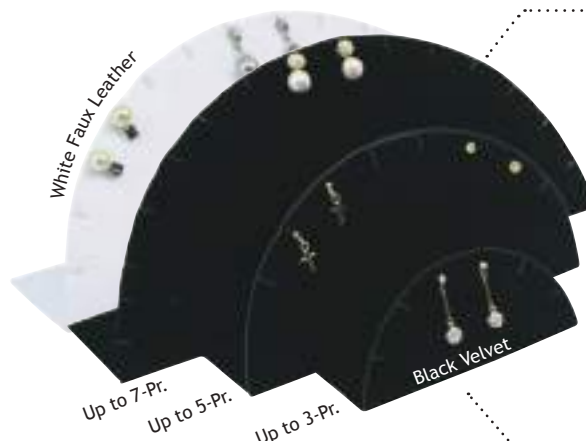

215-3 (BK)

215-3L (W)

Up to 7-Pr.
9 1/2" x 2" x 4" H
(240 x 51 x 100mm)

215-2 (BK)

215-2L (W)

Up to 5-Pr.
7" x 1 1/2" x 3 1/2" H
(178 x 38 x 89mm)

215-1 (BK)

215-1L (W)

Up to 3-Pr.
4 1/2" x 1 3/8" x 2" H
(114 x 35 x 51mm)

Wooden Bead / Earring Stands

- * Display an array of beads in style on this wooden display.
- * Simply slide the bar out of the notch, comes with protective stopper at both ends.



10 7/8" x 4 1/4" x 11" H
(277 x 109 x 280mm)

Wooden Earring Stands



F42-5 (RW)



Open for Extra Storage

Rosewood Base w/
White Faux Leather
3" x 3 1/2" x 2" H
(76 x 89 x 51mm)



F35-7 (RW)

Rosewood Trim w/
White Faux Leather
3" x 2 1/2" x 1 3/4" H
(76 x 63 x 44mm)



F42-4 (RW)

Rosewood Trim w/
White Faux Leather
2 1/2" x 1 3/4" x 4" H
(63 x 44 x 102mm)

Wooden Earring Stands



F27-2 (RW)

Rosewood Trim w/
White Faux Leather
1 7/8" x 1 7/8" x 4 1/4" H
(47 x 47 x 108mm)



F33-2 (RW)

Rosewood Trim w/
White Faux Leather
2" x 2" x 4" H
(51 x 51 x 100mm)



ED-724L -RW

Rosewood Trim w/
White Faux Leather
2" x 2 3/4" x 4 5/8" H
(53 x 70 x 117mm)



ED-726L -RW

Rosewood Trim w/
White Faux Leather
2" x 2 3/4" x 6 5/8" H
(53 x 70 x 168mm)



F7-20 (N)

Natural Wood Trim w/
White Faux Leather
2 1/4" x 2 7/8" x 4 1/4" H
(57 x 73 x 108mm)



F7-21 (N)

Natural Wood Trim w/
White Faux Leather
2 1/4" x 2 1/4" x 4 1/4" H
(57 x 57 x 108mm)

Fancy Earring Stands

2 3/4" x 2" x 3 1/2" H (70 x 50 x 10mm)



ED-0552 -75L

Chestnut Faux Suede w/
Brown Faux Leather Trim



ED-0552 -BK, G

Grey Suede
w/ Black Trim



ED-0552 -87R

Steel Grey Faux leather w/
Black Trim



ED-0552 -74L

Beige Faux Suede w/
Dark Brown Trim



ED-0552 -N3

Burlap w/
Natural Wood Trim



ED-0552 -RW

White Faux Leather
w/ Rosewood Trim

■ Arc Top Earring Stands



Black Velvet
-BK

White Faux Leather
L-WH

2 5/8" W x 1 3/4" D
(67 x 44mm)

ED1703 -Color
5 1/4" H (133mm)

ED1702 -Color
4 1/4" H (108mm)

ED1701 -Color
3 1/4" H (82mm)

■ Burlap Earring Stand



NEW

ED-723N -N3
2 1/4" x 2 1/4" x 4 1/4" H
(57 x 57 x 108mm)

■ Ring / Earring Stands



XD-726 -BK
XD-726L -WH

2 1/4" x 2 7/8" x 6 5/8" H
(57 x 73 x 168mm)

F7-20 (BK)
F7-20 (W)

2 1/4" x 2 7/8" x 4 1/4" H
(57 x 73 x 108mm)

XD721 -BK
XD721L -WH

2 1/4" x 2 1/4" x 3 1/2" H
(57 x 57 x 89mm)

■ Earring Stands

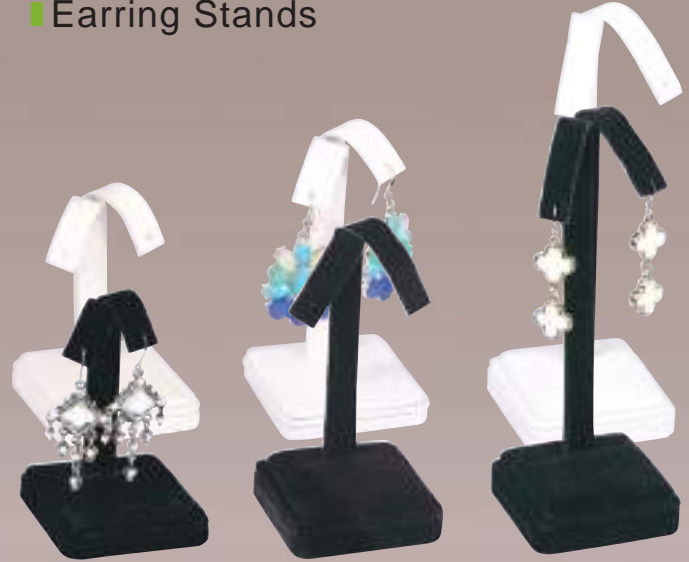

ED722 -BK
ED722L -WH

2 1/4" x 2 1/4" x 3 1/2" H
(57 x 57 x 89mm)

F7-21 (BK)
F7-21 (W)

2 1/4" x 2 1/4" x 4 1/4" H
(57 x 57 x 108mm)

ED-726 -BK
ED-726L -WH

2 1/4" x 2 1/4" x 6 5/8" H
(57 x 57 x 168mm)

Earring Collection

163

■ Fancy Earring Stands



Earring (Flap) Stand

ED-231L -WH

White Faux Leather

2 1/2" x 2 1/2" x 2 1/8" H
(64 x 64 x 55mm)

Earring Tree

XD-234L -WH

White Faux Leather

2 1/2" x 2 1/2" x 4 1/2" H
(64 x 64 x 114mm)

243

Black Velvet

4 3/4" H
(120mm)

243L (W)

White Faux Leather

4 3/4" H
(120mm)

243L (BK)

Black Faux Leather

4 3/4" H
(120mm)

246L (W)

White Faux Leather Base

4 5/8" H
(117mm)

246

Black Velvet Base

4 5/8" H
(117mm)

246L (BK)

Black Faux Leather

4 5/8" H
(117mm)

Pilot Style Earring Display

* Display up to 3 pairs of earrings

NEW



3" x 4 3/4" H
(75 x 120mm)

ED-2431V -BK
ED-2431L -WH



3" x 5 1/2" H
(75 x 140mm)

ED-2432V -BK
ED-2432L -WH



3" x 6 3/4" H
(75 x 170mm)

ED-2433V -BK
ED-2433L -WH

Black
Velvet
(BK)

White
Faux Leather
L (W)

Economic Stands

Flocked Cardboard
Metal Easel Back

3 3/8" W x 4" H (86 x 102mm)



257 (BK)
Flocked Black

257 (R)
Flocked Red

Lamp Style

Extra Tall

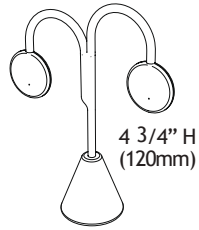

4 3/4" H
(120mm)

241-2 (Color)

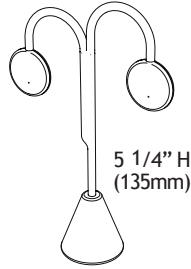

5 1/4" H
(135mm)

241-1 (Color)

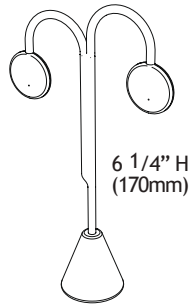

6 1/4" H
(170mm)

241-3 (Color)

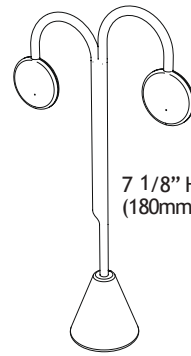

7 1/8" H
(180mm)

ED-2414 -Color



Available Colors

White
Faux Leather
L (W)

Black
Faux Leather
L (BK)

Black
Velvet
(BK)

Earring Collection

164

T-Shape Style

Extra Tall

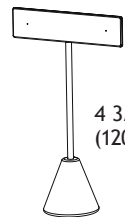

4 3/4" H
(120mm)

240-3 (Color)

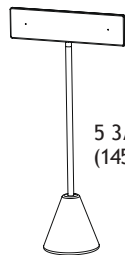

5 3/4" H
(145mm)

240-2 (Color)

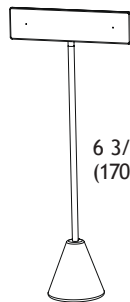

6 3/4" H
(170mm)

240-1 (Color)

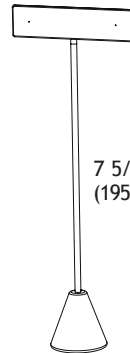

7 5/8" H
(195mm)

ED-2404 -Color



Available Colors

White
Faux Leather
L (W)

Black
Faux Leather
L (BK)

Black
Velvet
(BK)

Earrings Display Wings

12 1/2" W x 6 1/2" H (317 x 165mm)

* Hold 10-Pr. Earring



291 (BK)
Black Velvet

291L (BK)
Black Faux Leather

291L (W)
White Faux Leather

Earring Frame



2 1/4" x 4 3/8" H
(57 x 111mm)

240-9 (BK)
Black Velvet

240-9L (W)
White Faux Leather

Whale Style

- Black Faux Leather L (BK)
- Black Velvet (BK)
- White Faux Leather L (W)



248 (Color)

248-1 (Color)

Drop Shape Style

- Black Faux Leather L (BK)
- Black Velvet (BK)
- White Faux Leather L (W)

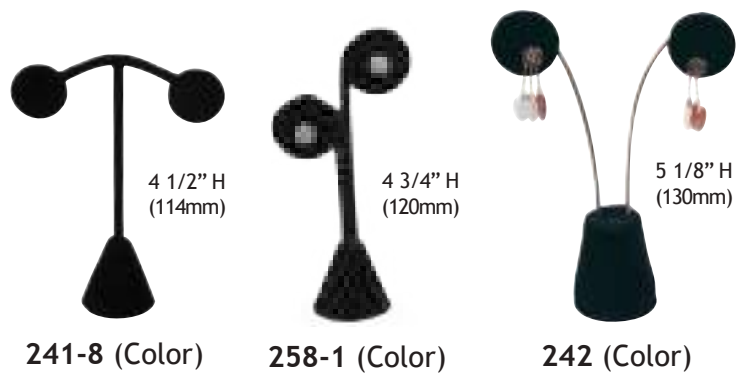

241-8 (Color)

258-1 (Color)

242 (Color)

Wing Style

- Black Velvet (BK)
- White Faux Leather L (W)



241-6 (Color)
Up to 5-Pr. Earrings

241-7 (Color)
Up to 5-Pr. Earrings

Butterfly Style

- Black Velvet (BK)
- White Faux Leather L (W)



241-4 (Color)
Up to 5-Pr. Earrings

241-5L (Color)
Up to 5-Pr. Earrings

Ginkgo Style

- Black Velvet (BK)
- White Faux Leather L (W)

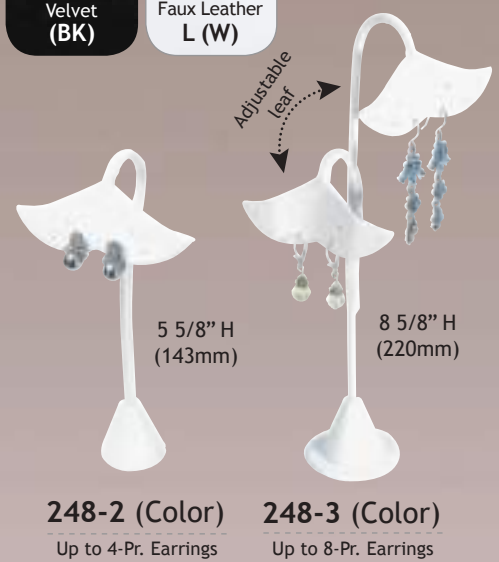

248-2 (Color)
Up to 4-Pr. Earrings

248-3 (Color)
Up to 8-Pr. Earrings

Earring Collection

165

Bar Earring Displays

- Black Velvet (BK)
- White Faux Leather L (W)
- Black Faux Leather L (BK)

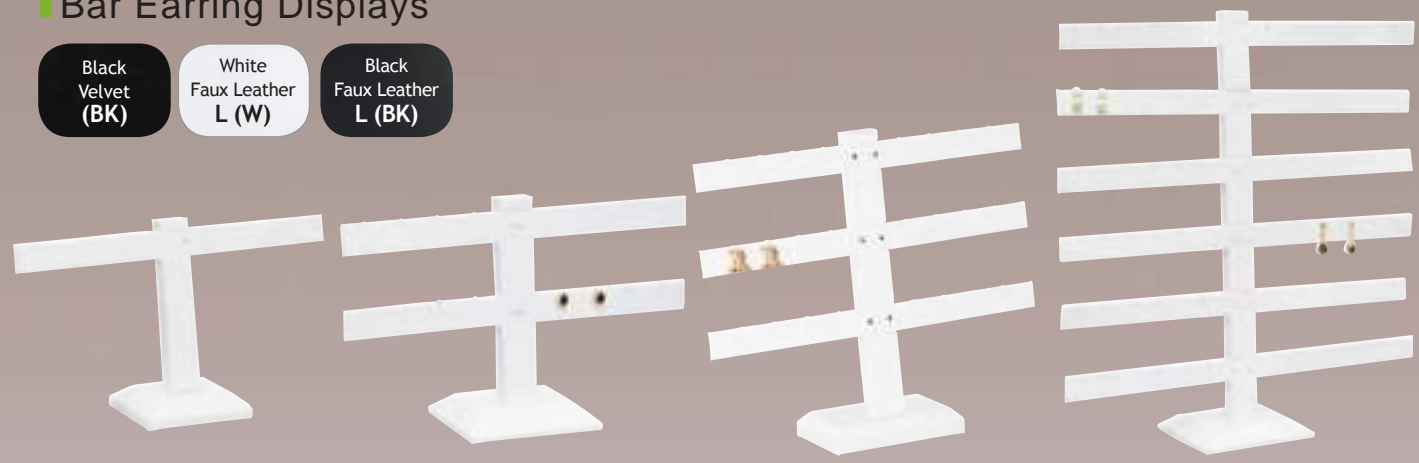

252-1 (BK)
252-1L (W)
252-1L (BK)
Holds 4-Pr. Earrings
10 1/4" W x 6" H
(260 x 152mm)

252-2 (BK)
252-2L (W)
252-2L (BK)
Holds 8-Pr. Earrings
10 1/4" W x 6 1/2" H
(260 x 165mm)

252-3 (BK)
252-3L (W)
252-3L (BK)
Holds 12-Pr. Earrings
10 1/4" W x 8 1/2" H
(260 x 216mm)

252-6 (BK)
252-6L (W)
252-6L (BK)
Holds 36-Pr. Earrings
14 1/8" W x 15 1/8" H
(359 x 384mm)

Rotating Hanging Earring Card Displays

- * Displays are shipped flat and individually packed. Assembly is required.
- * Holds any size earring card.
- * Earring cards sold separately.



Use hook extender for extra capacity.



3101

Holds 48 pcs. of 2" Cards
5" x 5" x 17" H
(12.5 x 12.5 x 43cm)



3101-1

Holds 32 pcs. of 2" Cards
5" x 5" x 12" H
(12.5 x 12.5 x 30.5cm)



3101-2

Holds 96 pcs. of 2" Cards
10" x 10" x 17" H
(25.5 x 25.5 x 43cm)



3106

Holds 144 pcs. of 2" Cards
10" x 10" x 24 1/2" H
(25.5 x 25.5 x 62.5cm)

3-Sided Rotating Stand

Holds 108 pcs. of 2" Cards
10 1/2" x 10 1/2" D x 19 1/2" H (26.5 x 26.5 x 49.5cm)



3103-1
Black Bar



3103
Clear Bar

4-Sided Rotating Stand

Holds 144 pcs. of 2" Cards
10 1/2" x 10 1/2" D x 19 1/2" H (26.5 x 26.5 x 49.5cm)



3104-1
Black Bar



3104
Clear Bar

5-Sided Rotating Stand

Holds 180 pcs. of 2" Cards
15" Dia. x 19 1/2" H (38 Dia. x 49.5cm)



3105-1
Black Bar



3105
Clear Bar

Hanging Earring Card Stand

Holds 36 pcs. of 2" Cards
8" x 3 3/4" D x 19" H (20.3 x 9.5 x 49cm)



1411 (BK)
Black Bar



1411 (CL)
Clear Bar

■ Rotating Acrylic Case for Hanging Earring Card



3201-1

Holds 32 pcs. of 2" Cards
8 7/8" x 8 5/8" x 13 3/4" H
(22.5 x 22 x 35cm)

■ Clear Acrylic Clip Hook

* Sold in packages of 50 Pc/PK



* Snap hook onto rotating earring display to expand display capacity.
* Display sold separately.



3201

Holds 48 pcs. of 2" Cards
8 1/4" x 8 1/8" x 18 1/2" H
(21 x 20.6 x 47cm)



3201-2

Holds 96 pcs. of 2" Cards
15 1/4" x 15 1/4" x 19" H
(39 x 39 x 48cm)



3206

Holds 144 pcs. of 2" Cards
15 1/4" x 15 1/4" x 26 1/2" H
(39 x 39 x 67cm)



3203

Holds 108 pcs. of 2" Cards
12 1/2" x 12 1/2" x 21 1/2" H
(32 x 32 x 54cm)



3204

Holds 144 pcs. of 2" Cards
15 1/4" x 15 1/4" x 21 1/2" H
(39 x 39 x 54cm)



3205

Holds 180 pcs. of 2" Cards
16" x 16" x 21 1/2" H
(40.5 x 40.5 x 54cm)

Earring Collection

167

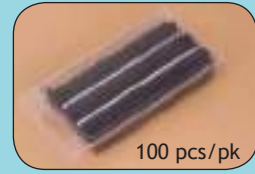
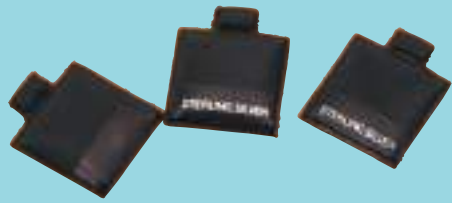

Vinyl White Puff Pad

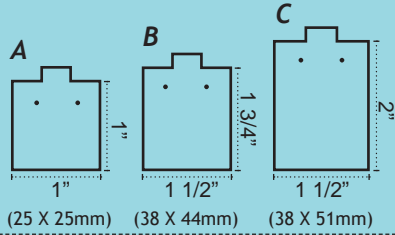

	Plain	14KT. Gold	10KT. Gold	Sterling Silver
A	BX565	BX565-1	BX565-2	BX565-3
B	BX595	BX595-1	BX595-2	BX595-3
C	BX585	BX585-1	BX585-2	BX585-3

Vinyl Black Puff Pad

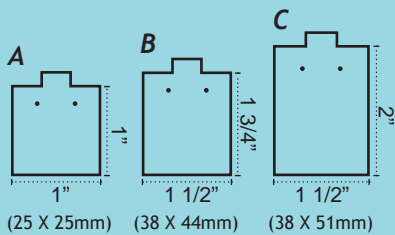

	Plain	14KT. Gold	10KT. Gold	Sterling Silver
A	BX565B	BX565B-1	BX565B-2	BX565B-3
B	BX595B	BX595B-1	BX595B-2	BX595B-3
C	BX585B	BX585B-1	BX585B-2	BX585B-3

Vinyl White Puff Pad Fancy Style

1 1/2" x 1 3/4" (38 x 44mm)



1 1/2" x 2" (38 x 51mm)



Puff Earring Pad

1 1/8" x 1 3/8" (28 x 35mm)

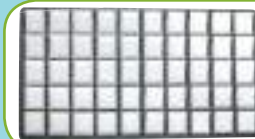

PT50 Liner can fit cards EP01, EP02, EP03. Cards sold separately.

Plain	14 KT. GOLD			10 KT. GOLD			STERLING SILVER		
EP01	EP01-1	EP02-1	EP03-1	EP01-2	EP02-2	EP03-2	EP01-3	EP02-3	EP03-3

Display Box w/36 Puff Pads Set

Case Size: 8 1/2" x 7 1/4" x 1" (220 x 184 x 25mm)
 Case holds 36 (1" x 1") pads with clear top cover + easel back

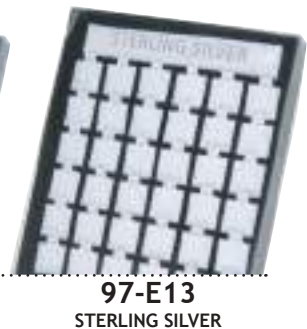
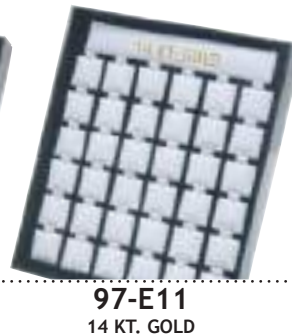

Hanging Earring Cards

Plastic earring cards are molded with hook tops for hanging displays. Designed to hold clip, wire, or post earrings. All have velour-flocked center.



French Clip Card 2" x 2" (51 x 51mm)

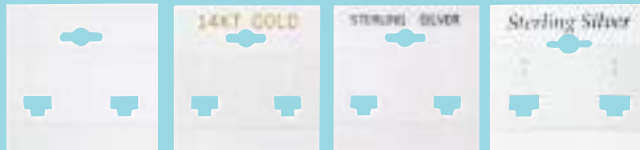

BX574 BX574G BX574S BX574SB

"Sterling Silver" Black Font

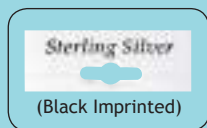

Size: W x H (mm)

1 1/2" x 1 1/2"	(38 x 38)
1 1/2" x 2"	(38 x 51)
2" x 2"	(51 x 51)



White



Grey

BX578SB	BX570SB
BX561-1SB	BX561-2SB
BX579SB	BX572SB

Plain

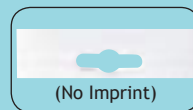

(No Imprint)



Black



White



Grey

Size: W x H (mm)

1 1/2" x 1 1/2"	(38 x 38)	BX571	BX578	BX570
1 1/2" x 2"	(38 x 51)	BX561	BX561-1	BX561-2
2" x 2"	(51 x 51)	BX573	BX579	BX572

"14 KT Gold"

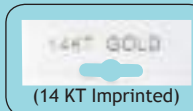

(14 KT Imprinted)



Black



White

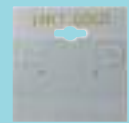

Grey

Size: W x H (mm)

1 1/2" x 1 1/2"	(38 x 38)	BX571G	BX578G	BX570G
1 1/2" x 2"	(38 x 51)	BX561G	BX561-1G	BX561-2G
2" x 2"	(51 x 51)	BX573G	BX579G	BX572G

"Sterling Silver" Silver Font

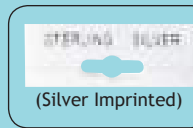

(Silver Imprinted)



Black



White



Grey

Size: W x H (mm)

1 1/2" x 1 1/2"	(38 x 38)	BX571S	BX578S	BX570S
1 1/2" x 2"	(38 x 51)	BX561S	BX561-1S	BX561-2S
2" x 2"	(51 x 51)	BX573S	BX579S	BX572S

Combination Jewelry Card



PC-9005S -WH

5 3/8" x 2 5/8"
(136 x 67mm)



* Combination card lets you display the set together.
* Jewelry not included.

Necklace Card

2" x 4" (51 x 102mm)

NC524 -K Kraft



NC524 (BK)

Black

Kraft Paper-Covered Plastic Hanging Cards

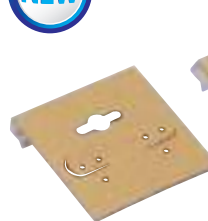

PC-5720P-K

1 1/2" x 1 1/2"
(38 x 38mm)

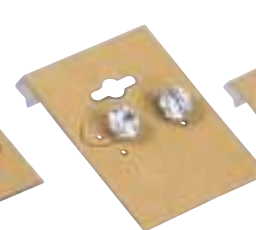

PC-5721P-K

1 1/2" x 2"
(38 x 51mm)



PC-5722P-K

2" x 2"
(51 x 51mm)

Multi-Pair Earring Card

2" x 2" (51 x 51mm)



PC-5712P-BK

Black



PC-5712P-BE

Beige



PC-5712P-WH

White

Clear Plastic J-Hook Hang Tabs

With the new clear hang tabs you can hang items to maximize visibility.

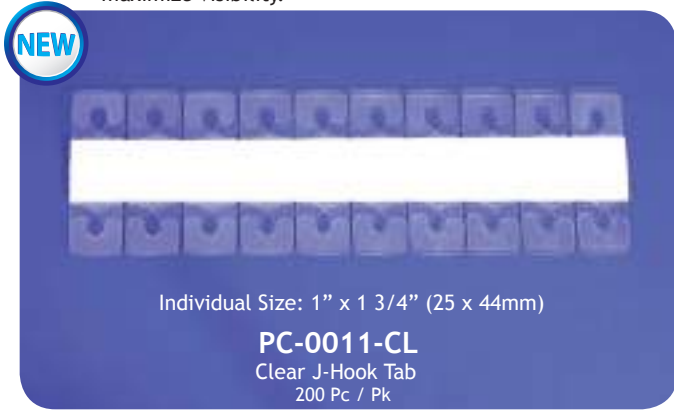

Individual Size: 1" x 1 3/4" (25 x 44mm)

PC-0011-CL
Clear J-Hook Tab
200 Pc / Pk



Use the hang tab adapter to change item into space-saving hanging item.

Clear Plastic Hang Tabs

This adapter allows you to hang almost any item as if it were an earring card.



PC-5011-CL
Clear Hang Tab
Individual Size:
1" x 1 5/8" (25 x 41 mm)
100 Pc / Pk



Peel off the paper tab



Press the adhesive to the card



Change into hanging card



Hang to display

Multi-Earring Card

Bend the top to stand at angle or hang on the hook with the hole.

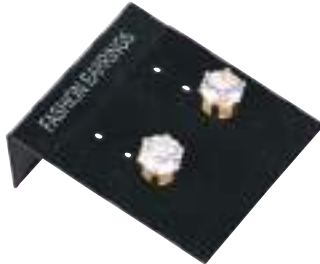

PC-5001S -BK
1 1/8" x 1 1/2"
(30 x 38mm)



Earring card fits tray liner #96-50 (fits 50 card inserts).



Hole for hook

Ring Card Insert

Secure your rings with these new ring cards.

Flat Size: 1 1/8" x 1 3/4" (30 x 46mm)



PC-1001P -WH
White Plastic



PC-1001P -BK
Black Plastic

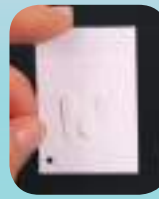

Bend Top



Slide the ring in

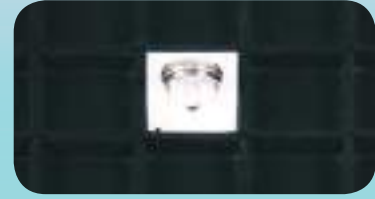

* Fits perfectly in tray liner #96-50 (fits 50 ring card inserts).

Necklace/Bracelet Cards

Folded Size:
1 3/8" x 1 3/4" (35 x 44mm)

NC-0001 -BK

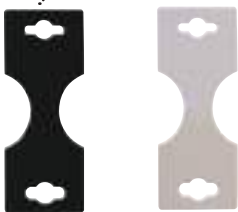

NC-0001 -WH



Fold the card and press the adhesive strip or staple to close.

Folded Size: 2 1/4" x 2 3/4" (57 x 70mm)



NC-0005 -BK
Black



NC-0005 -WH
White



NC-0005 -K
Kraft



Small Folding Mirror

4 3/4" x 6 1/4" H (121 x 159mm)

MR-1810W -O
Natural Oak

MR-1810W -VN
Vintage Wood



Wooden Foldable Mirror

10 1/2" x 3 1/4" x 7 1/2" H (260 x 82 x 191mm)

MR-1820W -VN
Vintage Wood



Adjustable Angle



This vintage style mirror is foldable and easy to store. Its height is adjustable to your preference.

Wooden Frame Mirror

10 1/2" x 4 1/4" x 12 1/2" H (267 x 108 x 317mm)

MR-1819W -DW
Dark Walnut

Adjustable Mirror



Wooden Oval Glass Mirror

9" x 6" x 14 1/2" H (228 x 152 x 368mm)

MR-1816W -RW
Rosewood

MR-1816W -DW
Dark Walnut Wood



Adjustable Mirror



Mirror Collection

171

Wooden Frame Mirror with Tray

10" x 6 1/4" x 13 1/2" H (254 x 160 x 343mm)

MR-1813B -N
Natural Wood

MR-1813W -RW
Rosewood

MR-1813W -BK
Black



Adjustable Mirror



Extra Compartment

■ Burlap Lace Snap Folding Mirror

7 1/4" x 10" H (184 x 255mm)



MR-1803 -N31
Burlap w/ Lace



* 3 snaps let you adjust to the best viewing angle.

■ Snap Folding Mirror

7 1/4" x 10" H (184 x 255mm)

1803 (W)
White Faux Leather

1803 (BK)
Black Faux Leather



* 3 snaps let you adjust to the best viewing angle.

■ Adjustable Folding Mirror

7" x 9 1/2" x 8 1/4" H (178 x 241 x 209mm)

Adjustable to three Different Viewing Positions

MR-1801L -BK
Black Faux Leather Cover



* Magnetic closure to ensure that mirror is safe.
* Gold tone corners.

■ Mirror Platform



Round



Square

Item	Size (Round)
MR-1851	2" Dia. (51mm)
MR-1852	3" Dia. (76mm)

Item	Size (Square)
MR-1860	2" x 2" (51 x 51mm)
MR-1862	4" x 4" (102 x 102mm)



Oval

Item	Size (Oval)
MR-1854	2" x 3" (51 x 76mm)
MR-1855	3" x 5" (76 x 127mm)
MR-1856	4" x 6" (102 x 152mm)

■ Black Acrylic Frame Glass Mirror



1804

7" x 11 1/2" H (178 x 292mm)



1804-1

7" x 14" H (178 x 355mm)



MR-1842 -BK

7 7/8" x 11 1/2" H (200 x 292mm)

Adjustable Mirror with Metal Base

MR-1261 -BZ
Bronze Finish

MR-1261 -BK
Black Finish

MR-1252 -BZ
Bronze Finish

MR-1252 -BK
Black Finish

MR-1251 -BZ
Bronze Finish

MR-1251 -BK
Black Finish



12 5/8" x 6" x 16 1/2" H
(321 x 152 x 419mm)



8 3/4" x 5 1/2" x 15 3/4" H
(222 x 140 x 400mm)



8 3/4" x 5 1/2" x 15 1/4" H
(222 x 140 x 387mm)

Frameless Mirror

8 3/4" x 11 3/4" H (222 x 298mm)

BX710

One Side Slanted
Acrylic Mirror



Square Glass Mirror

10" x 9 1/2" H (254 x 241mm)

1805-3

Clear Acrylic Frame

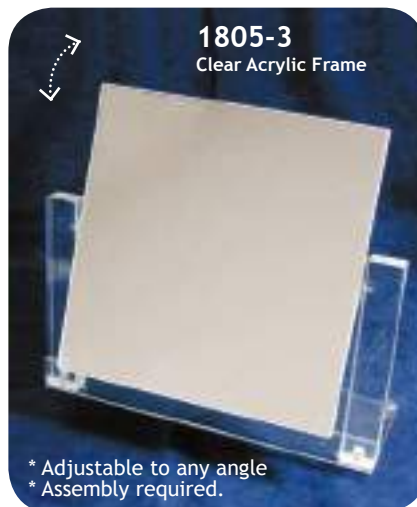

1805-1

Frosted Acrylic Frame



1805-2

Black Acrylic Frame

Brass Hinge Mirror

1802

Acrylic Stand Mirror

Adjustable to
+ or - 30°



12" x 16" H (305 x 406mm)

Counter Top Glass Mirror

1801-1

Adjustable to
any angle

Double Mirrors



14 1/4" x 19 1/2" H
(362 x 495mm)

1801

6 1/4" x 14 1/2" H
(160 x 370mm)

■ Wood Base Case with LED Lights

Low heat LED light, offers pure white light:
 -No adaptor needed, 100-240V.
 -30,000 hours of quality lighting.



Dark Walnut
-DW

TB2102W -DW
 Dark Walnut Base
 14 3/4" x 14 3/4" x 13 3/4" H
 (37.5 x 37.5 x 35cm)

■ Acrylic Full Size Tray Holders

AC-2002
 15 1/4" x 9 1/2" x 2 1/8" - 4 1/4" H
 (38.7 x 24.1 x 5.4 - 10.8cm)

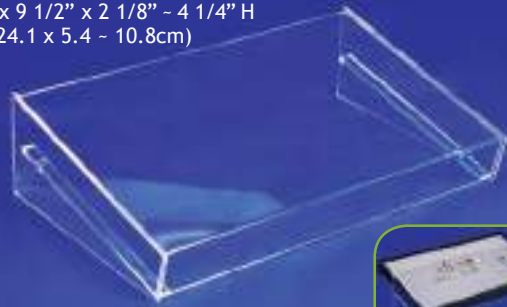

* Simply slide in a tray full of jewelry.
 * Jewelry, tray, insert are not included.

AC-2003
 15 1/4" x 10 1/2" x 3 1/4" - 5 1/2" H
 (38.7 x 26.7 x 8.2 - 14cm)

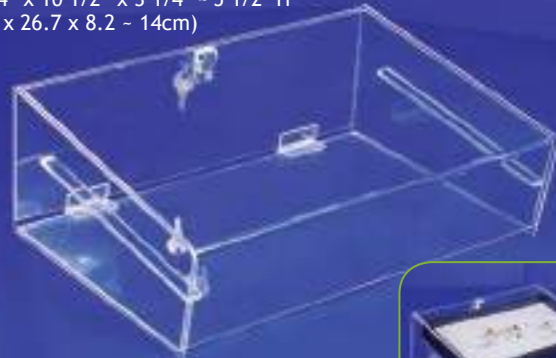

* With hinged door for extra protection.
 * Jewelry, tray, insert are not included.

■ 3"H Acrylic Showcase w/Lock

1464
 24 1/4" x 18 1/4" x 3" H (61.5 x 46 x 7.5cm)



* Camlock and two keys included.

■ 6"H Acrylic Showcase w/Lock

1463
 24 1/4" x 18 1/4" x 6" H (61.5 x 46 x 15cm)



* Camlock and two keys included.

■ Sliding Door Cases (6"H Shelf Clearance)

1467
 21 1/4" x 7 1/2" x 13 1/4" H (54 x 19 x 33.5cm)



* Features sliding doors and a keyed lock for maximum security.

■ Sliding Door Cases (4"H Shelf Clearance)

1468
 21 1/4" x 7 1/2" x 13 1/4" H (54 x 19 x 33.5cm)



* Features sliding doors and a keyed lock for maximum security.

3-Tier Countertop Display



1349
Each compartment is 2" D
20 7/8" x 6" x 10 1/2" H
(530 x 150 x 265mm)



1348
Each compartment is 1 3/4" D
12 3/4" x 10 3/8" x 6 1/4" H
(325 x 260 x 160mm)

Clear Acrylic Case w/Lock

* Keep valuables safe inside this case.



AC1465
14 5/8" x 8 1/8" x 1 1/2" H
(371 x 206 x 38mm)

Multi-Tier Bin Organizers

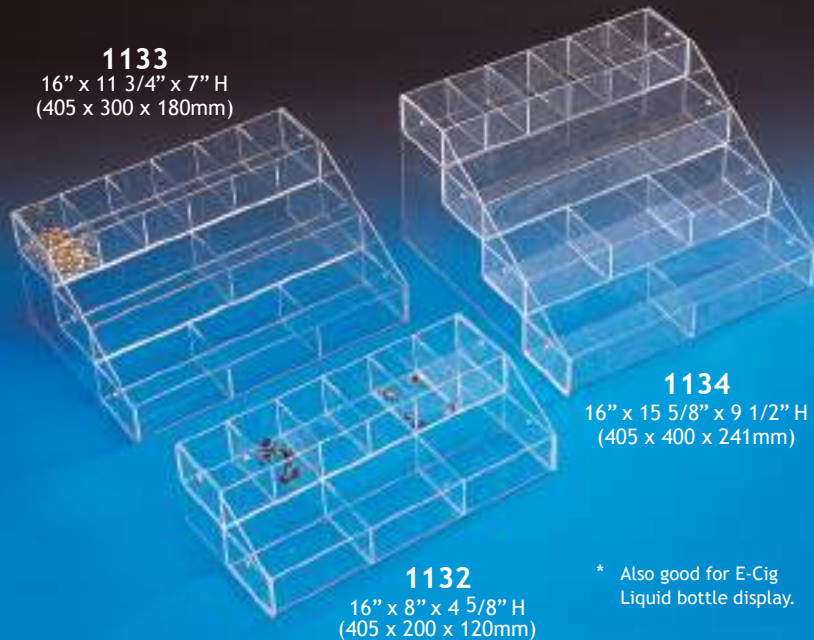

1133
16" x 11 3/4" x 7" H
(405 x 300 x 180mm)

1134
16" x 15 5/8" x 9 1/2" H
(405 x 400 x 241mm)

1132
16" x 8" x 4 5/8" H
(405 x 200 x 120mm)

* Also good for E-Cig Liquid bottle display.

2 Tier Countertop Display



1132-6
2 Tier (12 Bin Display)
16" x 8" x 4 5/8" H
(406 x 203 x 117mm)

Slatwall Bins

15 5/8" x 4" x 2 3/8" H (397 x 102 x 60mm)

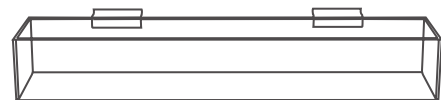

SD-0131 - 1 Compartment Tray



SD-0132 - 2 Compartment Trays

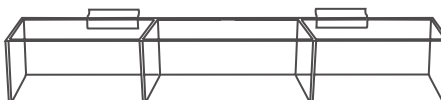

SD-0133 - 3 Compartment Trays



SD-0136 - 6 Compartment Trays

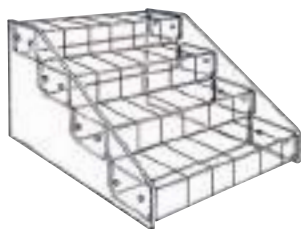

1134-6
4 Tier (24 Bin Display)
16" x 15 5/8" x 9 1/2" H
(405 x 400 x 241mm)



1134-1
4 Tier (4 Bin Display)
16" x 15 5/8" x 9 1/2" H
(405 x 400 x 241mm)



1133-6
3 Tier (18 Bin Display)
16" x 11 3/4" x 7" H
(405 x 300 x 180mm)



1133-1
3 Tier (3 Bin Display)
16" x 11 3/4" x 7" H
(405 x 300 x 180mm)

Acrylic Earring Stand

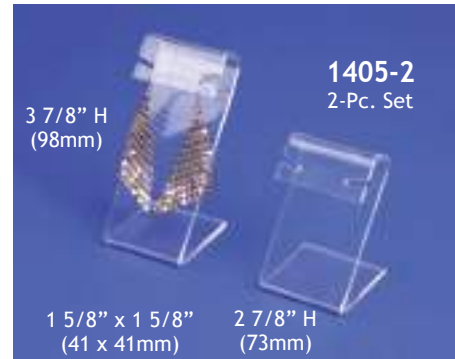
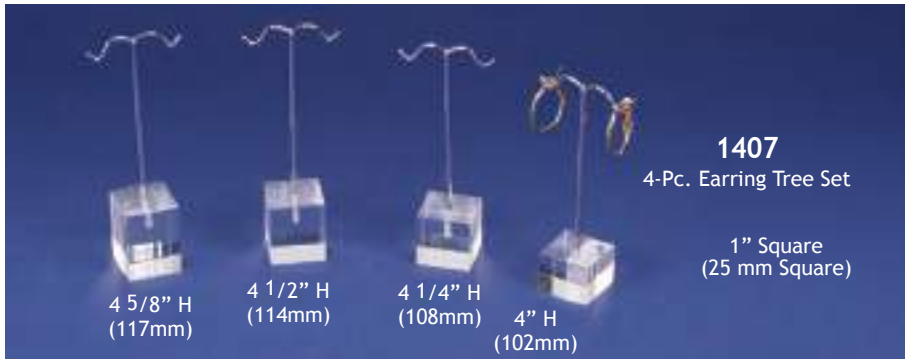
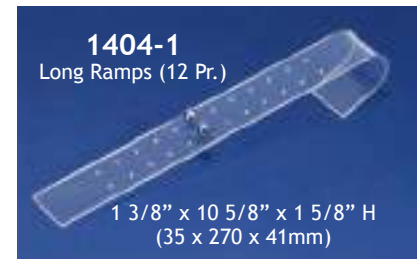
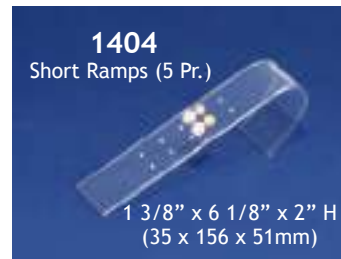
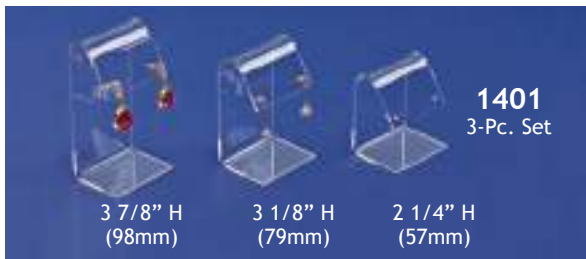
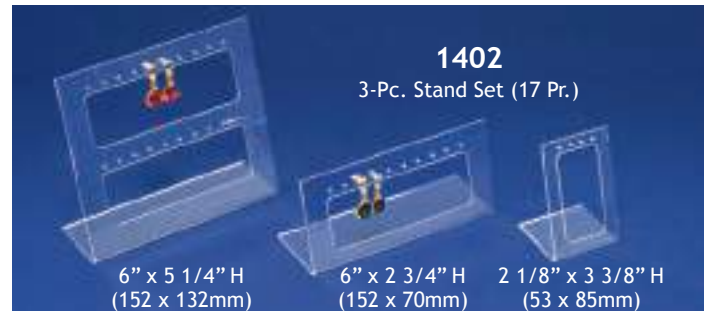
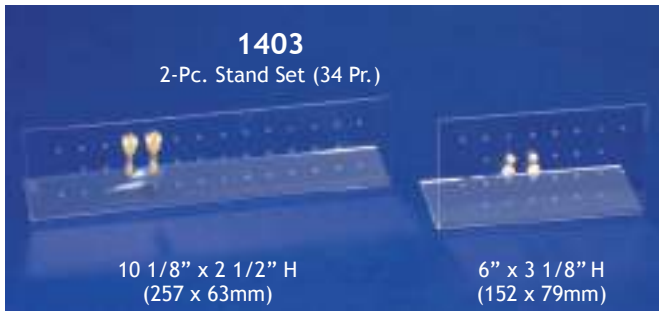
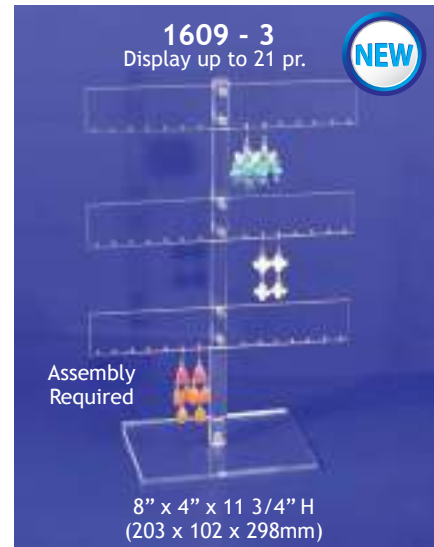
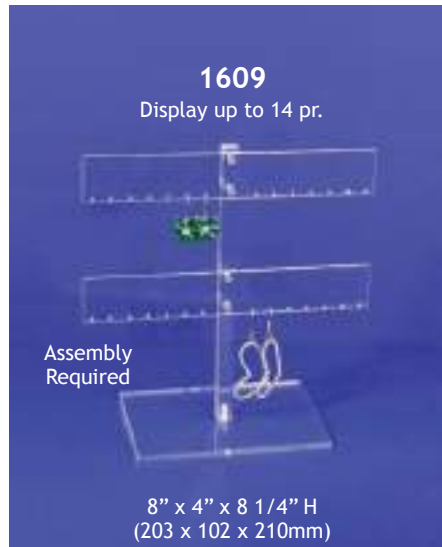
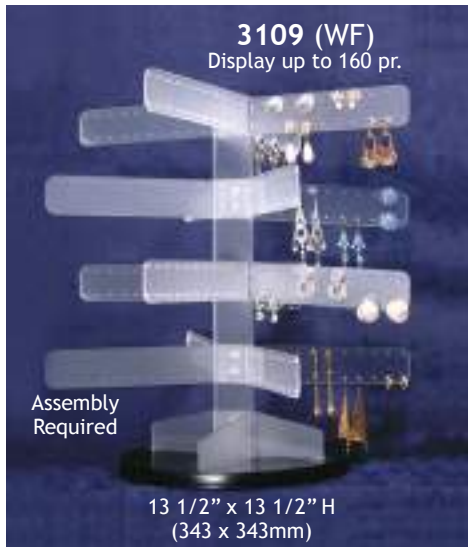

Acrylic Collection

176

Bangle Stands



Flat Acrylic Display

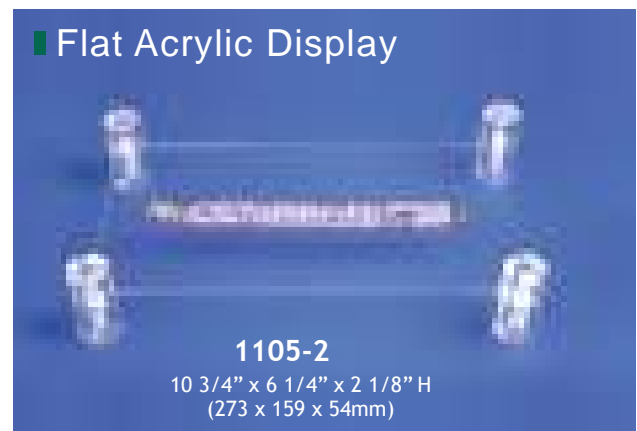

Multi-Platform Displays

- * Great for saving space and can easily adjust into many positions.
- * Each platform is 3" x 6", assembly required.



1121
10 1/4" H (260mm)
Oval Platform



1120
10 1/4" H (260mm)
Rectangular Platform

4 Tiers Display

- * White frost
- * Assembly required



1125 (WF)
11" x 11 1/2" x 11 1/2" H
(280 x 290 x 290mm)

Lipstick Displays

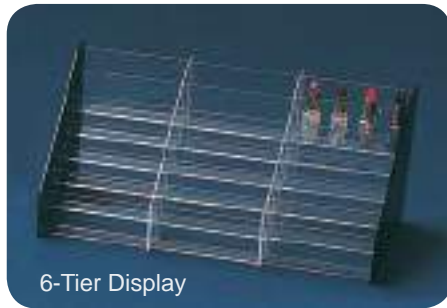

6-Tier Display

1901
18" x 7 5/8" x 7 3/8" H
(457 x 194 x 187mm)



Holds 2 Dozen

1907
8" x 5 1/2" x 2 7/8" H
(203 x 140 x 73mm)



Holds 2 Dozen

1908
8" x 5 1/2" x 2 7/8" H
(203 x 140 x 73mm)

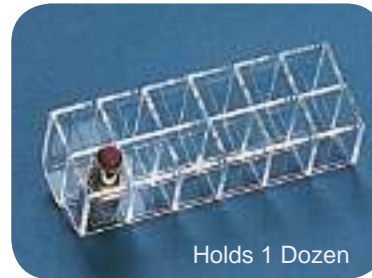
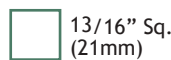

Holds 1 Dozen

1909
6 3/4" x 2 3/8" x 2 5/8" H
(171 x 60 x 67mm)

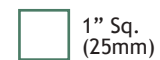

Acrylic Sign Holders

2 SIDED UPRIGHT

Item	Size: W x H (mm)
1212	5 1/2" x 3 1/2" (140 x 90)
1214	7" x 5" (178 x 127)
1216	7" x 5 1/2" (178 x 140)



2 SIDED UPRIGHT

Item	Size: W x H (mm)
1211	3 1/2" x 5 1/2" (90 x 140)
1213	5" x 7" (127 x 178)
1215	5 1/2" x 7" (140 x 178)



1 SIDED SLANT BACK

Item	Size: W x H (mm)
1218	5 1/2" x 3 1/2" (140 x 90)
1220	7" x 5" (178 x 127)
1222	7" x 5 1/2" (178 x 140)



1 SIDED SLANT BACK

Item	Size: W x H (mm)
1217	3 1/2" x 5 1/2" (90 x 140)
1219	5" x 7" (127 x 178)
1221	5 1/2" x 7" (140 x 178)



* See Store Supplies Selection for price sign selections

Acrylic Pen Display

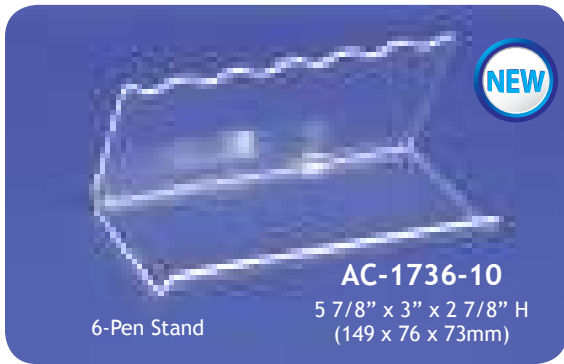

Blue/White Frosted Acrylic Displays

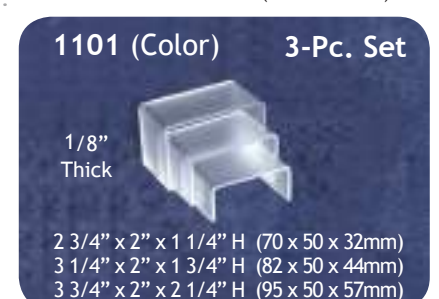
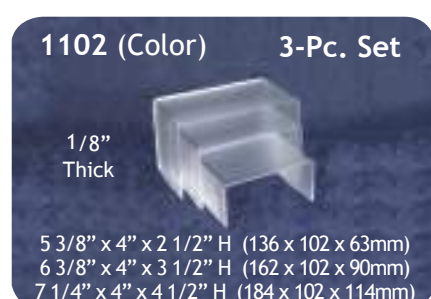
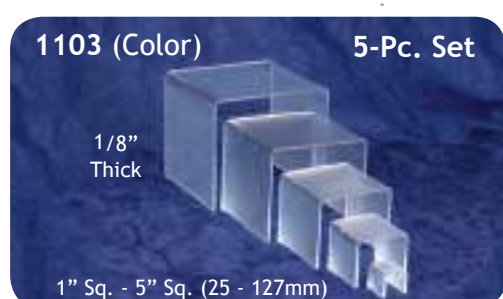
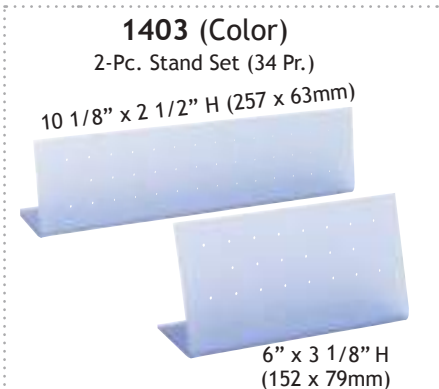
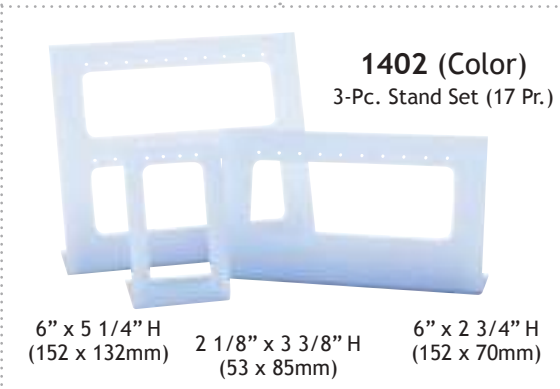
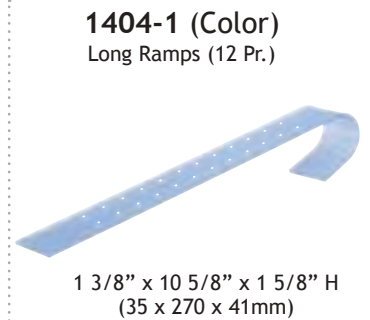

Acrylic Collection

Clear Acrylic Displays

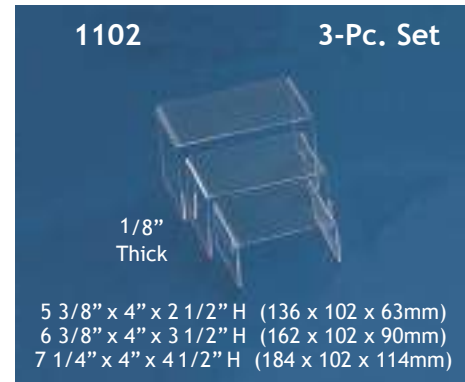
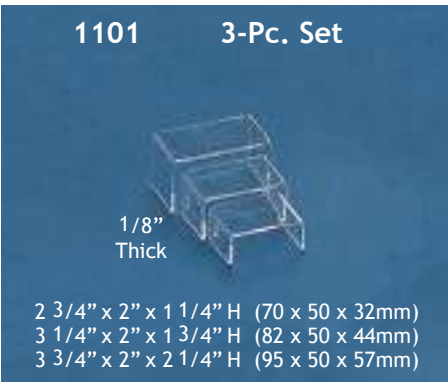
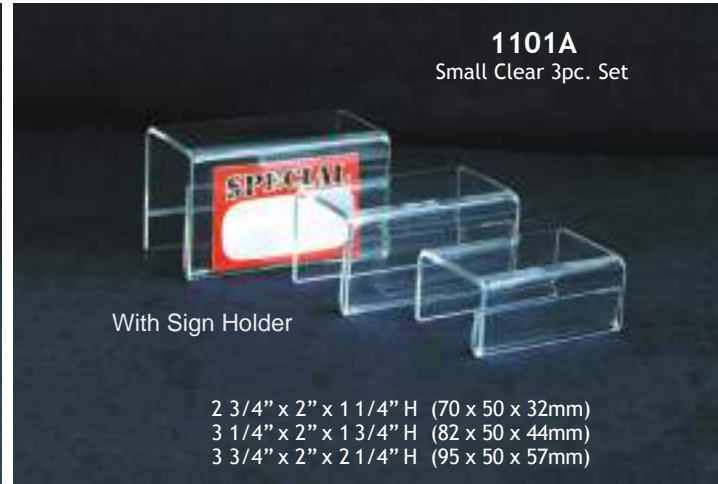
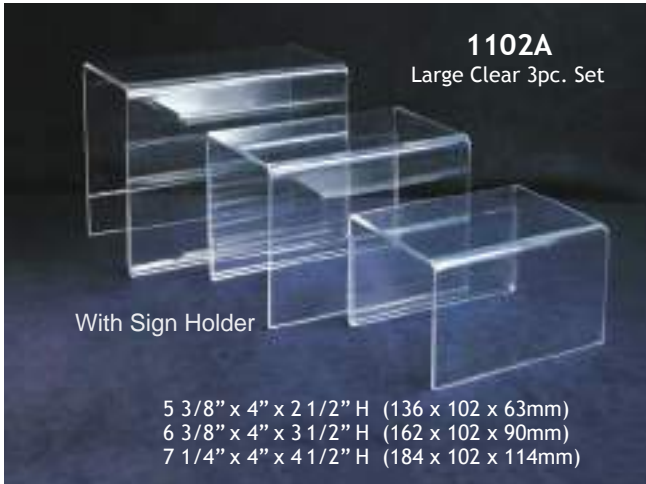

Acrylic Stands



Acrylic Earring/Bangle Display

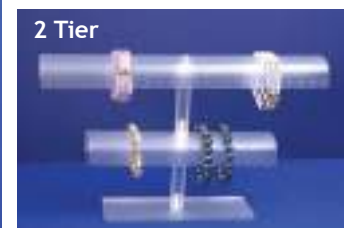
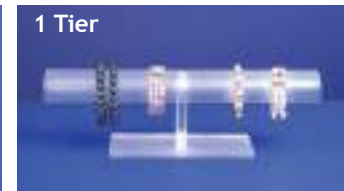

- * Semi-round adjustable (up to 3 Level). Perfect for earrings, bracelets and bangles.
- * Remove bars to make the display smaller.

Acrylic Cases

* Square case with 3 removable shelves

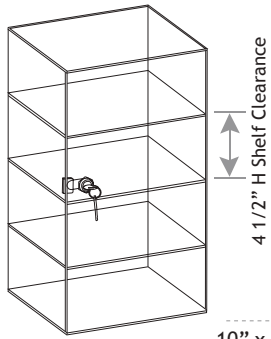

1109

10" x 10" x 18 1/2" H
(255 x 255 x 470mm)

* Revolving case with 3 removable shelves

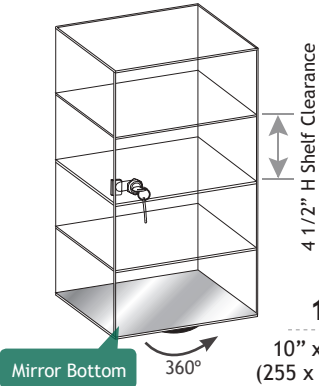

1109-B

10" x 10" x 19" H
(255 x 255 x 483mm)

* Display shelves, assembly required

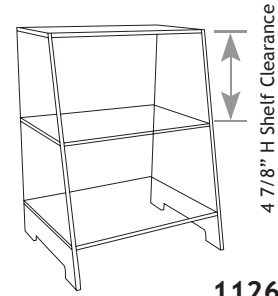

1126

9 5/8" x 7 7/8" x 12 1/4" H
(245 x 200 x 310mm)

* Revolving Case with 2 shelves

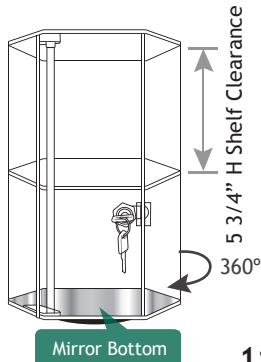

1141-B

8 1/4" Diag. x 12 7/8" H
(210 x 327mm)

* Revolving Case with 3 shelves

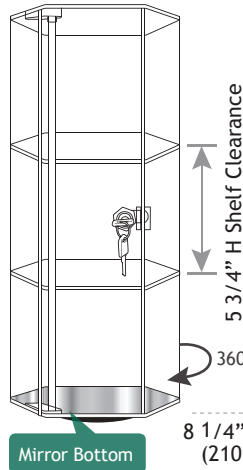

1142-B

8 1/4" Diag. x 18 7/8" H
(210 Diag. x 479mm)

* Revolving Case with 3 shelves

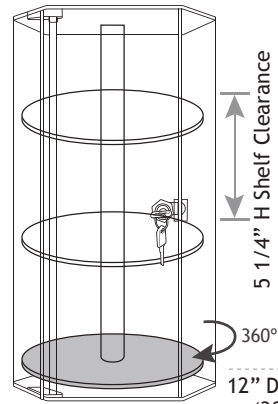

1107

12" Dia. x 18 1/8" H
(305 x 460mm)

* Revolving case with 4 removable shelves

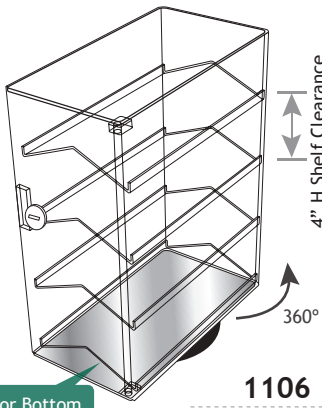

1106

13 1/2" x 7 3/8" x 17 3/4" H
(340 x 190 x 440mm)

* Revolving case with 5 removable shelves

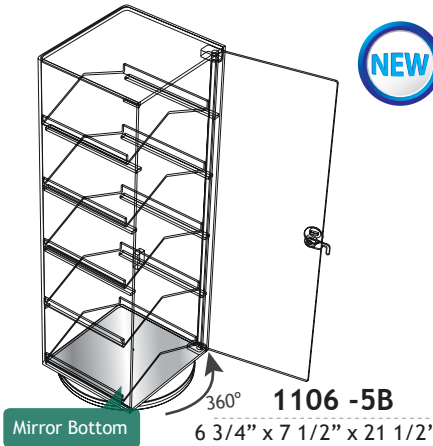

1106-5B

6 3/4" x 7 1/2" x 21 1/2" H
(170 x 190 x 550mm)

* Necklace Showcase with key lock

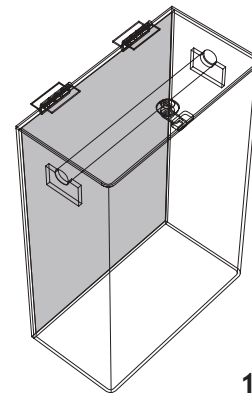

1469

10 1/4" x 5 1/4" x 15" H
(260 x 130 x 380mm)

Acrylic Collection

180

Gem Jar Inserts for Countertop Showcase

* Choose your gem jar insert to fit perfectly in acrylic case 1106



12 3/8" x 3 1/2" x 3/4" H (314 x 89 x 19mm)

Round Jar Insert

1106-P1E	Empty Jar
1106-P1 (BK)	Black Foam
1106-P1 (W)	White Foam

Rectangle Jar Insert

1106-P5E	Empty Jar
1106-P5 (BK)	Black Foam
1106-P5 (W)	White Foam

Square Jar Insert

1106-P6E	Empty Jar
1106-P6 (BK)	Black Foam
1106-P6 (W)	White Foam

Diamond Cut Crystals

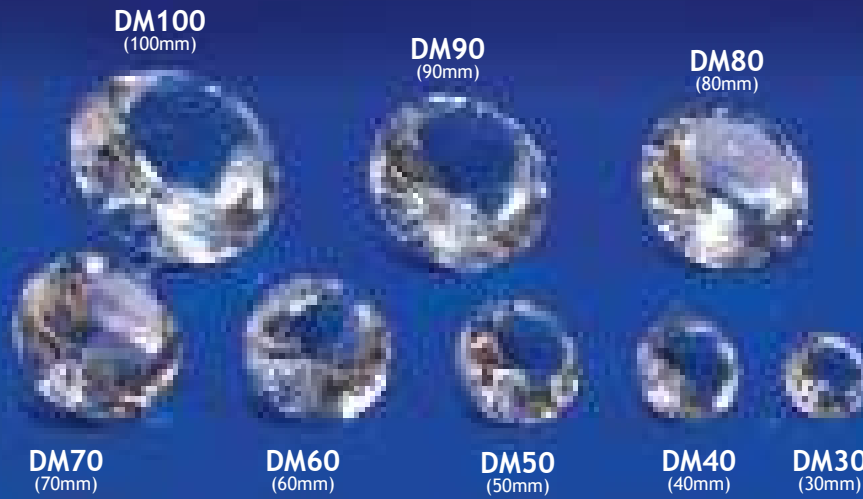

DM100
(100mm)

DM90
(90mm)

DM80
(80mm)

DM70
(70mm)

DM60
(60mm)

DM50
(50mm)

DM40
(40mm)

DM30
(30mm)

Display Cubes

Base: 5 1/2" x 5 1/2" (140 x 140mm)

Cover: 5" x 5" x 5" H (127 x 127 x 127mm)

Jewelry not included.



1451
Cover with
black base

1450
Clear Cover

Acrylic T-Bar Display



1326
Flat Bar
12" x 5" H
(305 x 125mm)



1327
Half-Round Bar
11 1/2" x 5" H
(292 x 125mm)



Slatwall T-Bar

1328
10" W (255mm)



1329
Single Round Bar
10" x 4 7/8" H
(255 x 124mm)



1325
Hexagonal Bar
10" x 8" H
(255 x 203mm)



1330
Double Round Bar
10" x 9 3/4" H
(255 x 248mm)

Frosted Acrylic Displays



1674
7 1/2" x 8 1/4" H
(180 x 210mm)



1408
Wing Stand (19 Pr.)
12 1/2" x 6" H
(317 x 152mm)

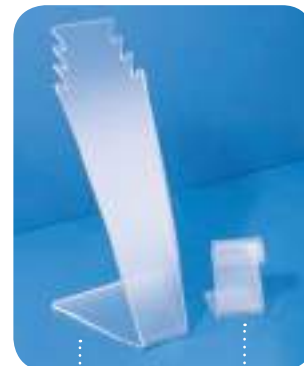

1603
3 1/4" x 9 1/4" H
(82 x 235mm)



1601
8 1/4" x 11 3/4" H
(210 x 298mm)



1405
1 5/8" x 2 3/8" H
(41 x 60mm)



1676
8 3/8" x 10 1/4" H
(213 x 260mm)



1406
1 1/8" x 2 1/2" H
(28 x 63mm)

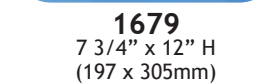

1679
7 3/4" x 12" H
(197 x 305mm)

Single Gem Box Displays

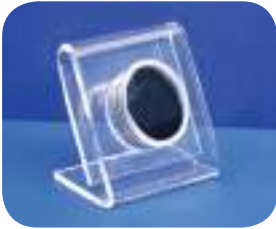

1308 -BK
1308 -WH

Comes with 1 - Gem Boxes (#S)

2 1/4" x 1 1/2" x 2 1/8" H
(57 x 38 x 54mm)

* Choice of black and white foam insert.

Double Gem Box Displays



1309 -BK
1309 -WH

Comes with 2 - Gem Boxes (#S)

3 1/4" x 1 1/2" x 2 1/4" H
(82 x 38 x 57mm)

* Choice of black and white foam insert.

Small Acrylic Gem Displays

6 1/8" x 3 1/2" x 5 1/8" (156 x 90 x 130mm)

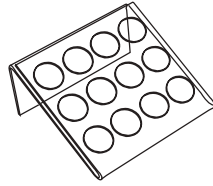
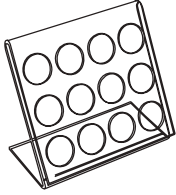

2 Display Options

- * Additional displaying angles
- * Gem jars sold separately.
- * Good to display Body Jewelry.



1306-1
Holds 12 - Gem Jars (#S)

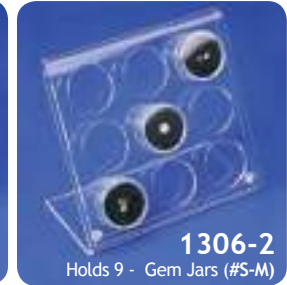

1306-2
Holds 9 - Gem Jars (#S-M)



1306-3
Holds 6 - Gem Jars (#S-L)



1306-5
Holds 8 - Gem Boxes (#1305)



1306-6
Holds 16 - Gem Boxes (#1806)



1306-7
Holds 9 - Gem Boxes (#1807)



1306-9
Holds 16 - Gem Boxes (#1809)

Large Acrylic Gem Displays

14 1/4" x 4 1/2" x 7 5/8" H (362 x 114 x 194mm)

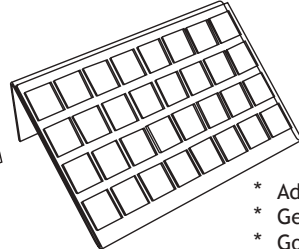
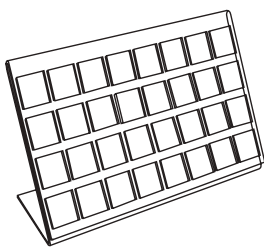

2 Display Options

- * Additional angles of displaying.
- * Gem jars sold separately.
- * Good to display Body Jewelry.



1307-1
Holds 50 - Gem Jars (#S)



1307-2
Holds 32 - Gem Jars (#S-M)



1307-3
Holds 21 - Gem Jars (#S-L)



1307-5
Holds 36 - Gem Boxes (#1305)

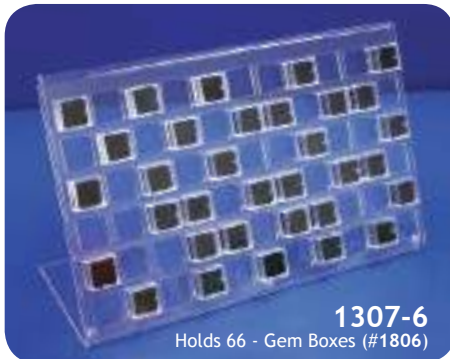

1307-6
Holds 66 - Gem Boxes (#1806)



1307-7
Holds 32 - Gem Boxes (#1807)

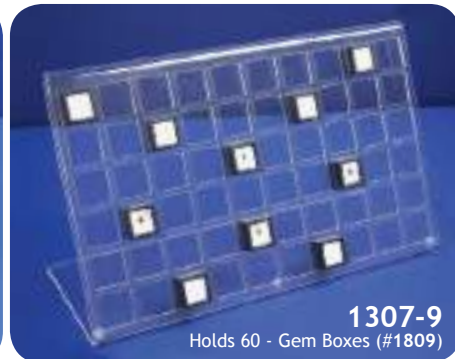

1307-9
Holds 60 - Gem Boxes (#1809)

Frosted Plastic Organizers

BX86

17 Compartments
10 3/4" x 7" x 1 3/4"
(272 x 178 x 45mm)



BX88

12 Adjustable Dividers Included
9 7/8" x 7 1/8" x 1 1/2"
(250 x 180 x 38 mm)



BX85
6 Compartments
8 1/4" x 5" x 1 3/8"
(210 x 127 x 35mm)



BX80
6 Compartments
4 3/4" x 3 1/2" x 3/4"
(120 x 89 x 21mm)

BX81
12 Adjustable Dividers Included
7 7/8" x 5 1/4" x 1 1/2"
(200 x 135 x 40mm)



NEW

BX-8330
18 Compartments
6" x 6" x 5" H
(152 x 152 x 127mm)



- * 3-layer plastic organizer, great for beads, findings, tools, and supplies.
- * Removable dividers
- * Customizable compartments
- * Sides open, snap-close lock.



NEW

BX-8313
Up to 24 Compartments
7 7/8" x 5 3/8" x 1 1/2" H
(200 x 135 x 38mm)

21 Adjustable dividers included

Snap-close Lid

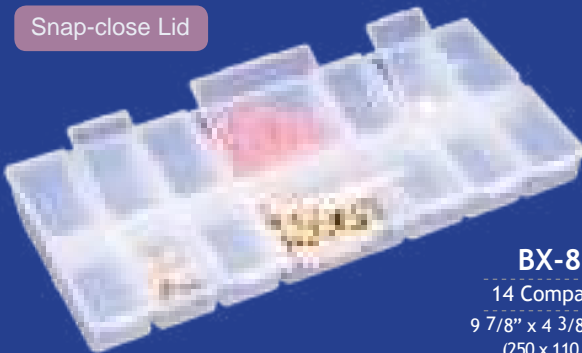

NEW

BX-8324
14 Compartments
9 7/8" x 4 3/8" x 1 1/8" H
(250 x 110 x 28mm)



NEW

BX-8323
12 Compartments
7 1/4" x 5 1/2" x 3/4" H
(188 x 140 x 30mm)



NEW

BX-8322
5 Compartments
5 3/4" x 4" x 1 1/4" H
(145 x 102 x 32mm)



NEW

BX-8312
Up to 10 Compartments
5 1/8" x 2 5/8" x 7/8" H
(130 x 67 x 22mm)



NEW

BX-8301
8 Compartments
4" Dia. x 1" H
(102 x 25mm)

■ Glass Top Gem Jars with 2-Sided Foam Insert

* Double sides foam BK and WH to highlight any stone color.



Black and White Reversible Pad

1807 (BK)
Large Black Jar

1809 (BK)
Small Black Jar

1809 (W)
Small White Jar

1807 (W)
Large White Jar

1809 Size: 1 1/16" x 1 1/16" x 3/4" H
(26 x 26 x 18mm)
1807 Size: 1 1/2" x 1 1/2" x 3/4" H
(38 x 38 x 18mm)

Gem Collection

■ Round Gem Jars

Large Round Jars 1 3/4" Dia. (45mm)



S-L (W)

S-L (BK)

S-L

Medium Round Jars 1 3/8" Dia. (35mm)



S-M (W)

S-M (BK)

S-ME

Small Round Jars 1 1/8" Dia. (30mm)



S (W)

S (BK)

S-SE

■ Square Gem Jars

1" x 1" x 3/4" H
(25 x 25 x 18mm)



1806 (W)
White Foam

1806 (BK)
Black Foam

1806E
Empty Box

■ Rectangular Gem Boxes

2" x 1" x 3/4" H
(51 x 25 x 18mm)



1305 (BK)
Black Foam

1305 (W)
White Foam

1305E
Empty Box

■ Labels for Gem Jar

Each Round Label Size : 1" Dia. (25mm)

* Preprinted paper tag for gem box, box not included

■ Coin Holder

* Coin not included.



LB

Non-Adhesive
1000 Pc/Pack

LB-1

Adhesive
500 Pc/Pack

TA791E

Adhesive
500 Pc/Pack



PA

Rectangular Label
100 Pc/Pack
2 1/2" L x 3/4" W
(62 x 18mm)



CB301

PVC Coin Holder
Inner Dia. 1 5/8" (40mm)

Glass Top Gemstone Display w/ 2-Sided Foam Insert

Each Jar Size : 2 7/8" W x 2 1/4" D x 5/8" H (73 x 57 x 16mm)

* Secure snap lock



GB-0001-WH
White Finish



GB-0001-BK
Black Finish



GB-0001-BL
Blue Finish

NEW



GB-0001-C90
Chrome Finish

NEW

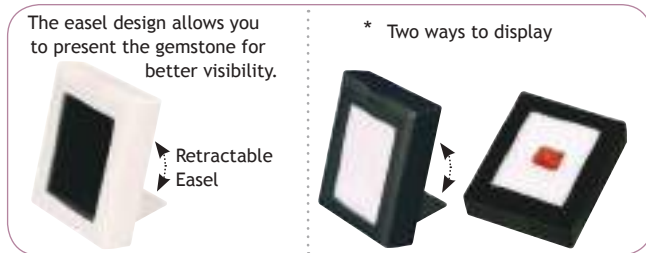

Glass Top Gem Box

* The Black faux leather box has secure lock, glass-top and reversible black/white insert, 2 piece-packer included.



W901L -BK
2" x 2 3/8" x 1" H
(50 x 60 x 25mm)



W902L -BK
3 3/8" x 2 1/2" x 1" H
(86 x 62 x 25mm)



Frost Acrylic Gem Boxes

Each Jar Size : 2" W x 2" D x 7/8" H (51 x 51 x 22mm)

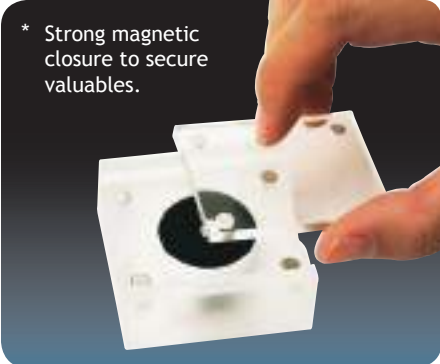

Round Gem Jar Foam Liners



83-2L (BK) Foam with 24 Large
1 3/4" Dia. Jars
83-2L (W) 14 1/2" x 7 7/8" x 3/4" H
(368 x 200 x 18mm)



83-2M (BK) Foam with 36 Medium
1 3/8" Dia. Jars
83-2M (W) 14 1/2" x 7 7/8" x 3/4" H
(368 x 200 x 18mm)



83-2 (BK) Foam with 50 Small
1 1/8" Dia. Jars
83-2 (W) 14 1/2" x 7 7/8" x 3/4" H
(368 x 200 x 18mm)



84-2L (BK) Foam with 12
Large Jars
84-2L (W) 7 7/8" x 7 7/8" x 3/4" H
(200 x 200 x 18mm)



84-2M (BK) Foam with 16
Medium Jars
84-2M (W) 7 7/8" x 7 7/8" x 3/4" H
(200 x 200 x 18mm)



84-2 (BK) Foam with 25 Small Jars
84-2 (W) 7 7/8" x 7 7/8" x 3/4" H
(200 x 200 x 18mm)



80 (BK) Empty Full-Tray Liner
80 (W) 14 1/2" x 7 3/4" x 5/8" H
(362 x 198 x 16mm)



86-2 (BK) Foam with 15
Small Jar
86-2 (W) 7 3/4" x 4 1/4" x 3/4" H
(198 x 110 x 18mm)



85-2 (BK)
Black Foam with 6 Small Jars
5 1/2" x 3 1/4" x 3/4" H
(140 x 82 x 18mm)

Gem Parcel Boxes



850-2
4" x 6 1/8" x 2 3/4" H
(102 x 156 x 70mm)

850-1
4" x 11 3/8" x 2 3/4" H
(102 x 289 x 70mm)



* Can hold parcel papers
up to size 3 1/4 x 2"
* Parcel papers are not
included.

Mini Folders



783
3 1/2" x 8 1/2" H
(89 x 216mm)

Gem File Card Holders

*Cards not included.



1111
4" x 2 3/8" x 1/2" H
(102 x 60 x 13mm)



1112
11/16" x 2 1/4" H
(17 x 56mm)

Snap-Close Gemstone Tray

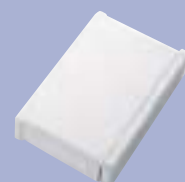

Closed View

80-43B (W)
White Faux Leather Tray
6" x 4"
(152 x 102mm)

Acrylic Gemstone Display

1315

3-Pcs. Round Set
1" Dia. x 1" - 3" H
(25Dia. x 25 - 75mm)



1316

4-Pcs. Square Set
1" Sq. x 1/2" - 2" H
(25 x 25 x 13 - 50mm)



■ Snap-Close Lid Trays with 50 Gem Jars

14 3/4" x 8 1/4" x 1 1/8" H



NEW

BX-2531D-WH
Black Tray with White Foam



NEW

BX-2531D-BK
Black Tray with Black Foam

■ Stackable Gem Jar Trays

Each Tray Size: 8 1/4" W x 7 1/4" D x 1" H (210 x 184 x 25mm)



Carry these trays w/ 91-G & 91-H soft duffle bag.

Available Colors



Black Tray w/ Black Inserts
-BB

Black Tray w/ White Inserts
-BW



TY-2051 -Color
20 Round Jar Tray



TY-2054 -Color
25 Square Jar Tray



TY-2055 -Color
15 Rectangular Jar Tray

■ Stackable Plastic Trays

* Comes with 50 Gem Jars
14 3/4" x 8 1/4" x 1" H (375 x 210 x 25mm)

BX250

White Plastic Tray with White Foam



BX251
Black Plastic Tray with Black Foam

■ Wooden Trays

* Comes with 50 Gem Jars
14 3/4" x 8 1/4" x 1" H (375 x 210 x 25mm)

BX252 (W)

Black Wood Tray with White Foam



BX252 (BK)
Black Wood Tray with Black Foam

■ Cardboard Tray

* Comes with 50 Gem Jars

14 1/2" x 8 1/4" x 1" H
(368 x 210 x 25mm)



Clear Vinyl Cover for extra protection

BX2651 -BK
Lightweight

Gem Collection

187

■ 36 Gem Boxes Acrylic Tray

14 1/2" x 8" x 1" H (368 x 203 x 25mm)

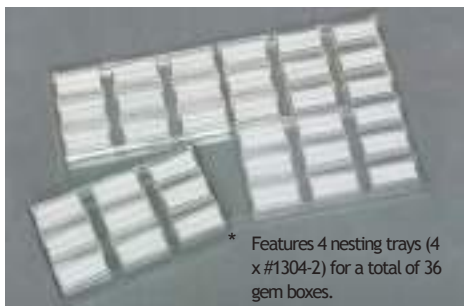

* Features 4 nesting trays (4 x #1304-2) for a total of 36 gem boxes.

1304-3 (BK)
Black Foam

1304-3 (W)
White Foam

■ 9 Gem Boxes Acrylic Tray

7" x 3 7/8" x 3/4" H (178 x 98 x 20mm)



1304-2 (BK)
Black Foam



1304-2 (W)
White Foam

■ Acrylic Empty Tray

14 1/2" x 8" x 3/4" H (370 x 203 x 18mm)



1304 -31
Empty Tray

View-Top Wood Tray



* Sturdy wood tray with dividers holds 10 bins (PN2) convenient to store & display. Bin and Tray sold separately.

15 1/4" x 8 3/4" x 2" H
(388 x 222 x 52mm)

Acrylic view-top lid



TY-3102
View Top Bin Tray

Utility Plastic Bins

3 7/8" x 2 7/8" x 1 3/4" H
(99 x 73 x 44mm)



PN2 (BK)
Black Bin

PN2 (W)
White Bin

Universal Cases with Pins

* Features sturdy cardboard, glass top panel, thick poly-fill wadding, and 4 secure pins.



3/4" H (19mm) Cases:



RK120
4" x 3"
(102 x 76)

RK130
5" x 4"
(127 x 102)

RK135
6" x 5"
(152 x 127)

RK150
12" x 8"
(305 x 203)

RK160
12" x 16"
(305 x 405)

2" H (51mm) Cases:

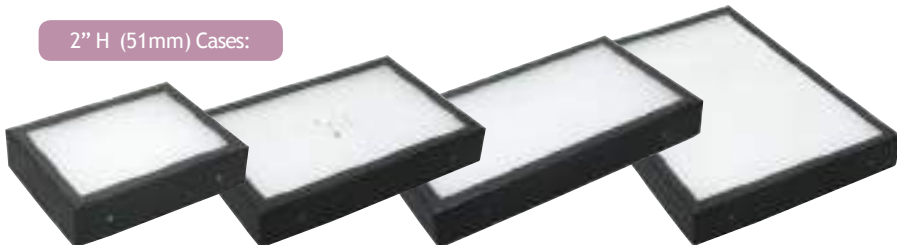

RK340
8" x 6"
(203 x 152)

RK350
12" x 8"
(305 x 203)

RK270
14" x 8"
(355 x 203)

RK360
12" x 16"
(305 x 405)

Bead Design Boards

* Made of flocked plastic



T13F (G) 21" x 8" x 5/8"
(538 x 203 x 15mm)



T14F (G) 21" x 8" x 5/8"
(538 x 203 x 15mm)



T12F (G) 21" x 10 1/2" x 5/8"
(538 x 265 x 15mm)



T15F (G)
12 1/2" x 8 1/2" x 5/8"
(318 x 215 x 15mm)

Wooden Bead Display Stands

* Simply slide the bar out of the notched, protective stopper at both ends.
10 7/8" x 4 1/4" x 11" H (277 x 109 x 280mm)

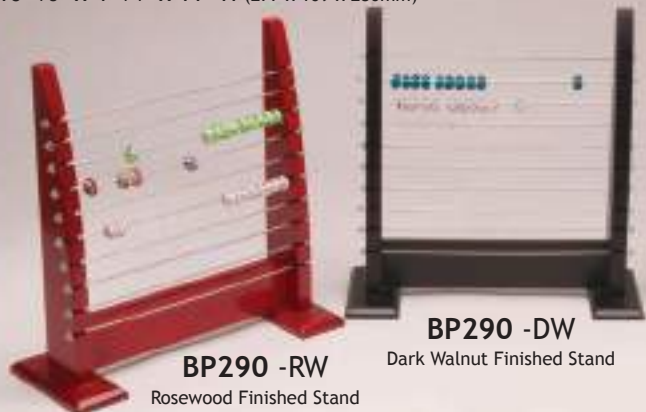

BP290 -RW
Rosewood Finished Stand

BP290 -DW
Dark Walnut Finished Stand

Durable Wooden Bead Boards

Measured in inches.

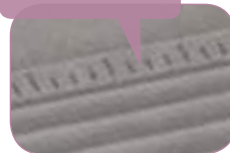

T-11 (G)
21" x 8 3/4"
(533 x 222mm)

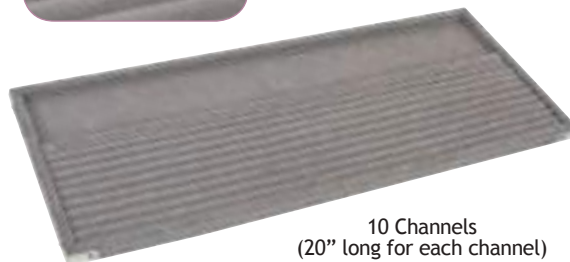

10 Channels
(20" long for each channel)

Presentation Portfolio with Handle

- * Features slim design and pull-out handle.
- * Black leatherette exterior and velvet interior.



Closed: 10" x 14" (254 x 357mm)

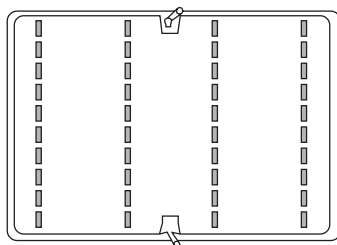

70-1C3

Watch/Bracelet -20 Sections with Foam Pad Insert

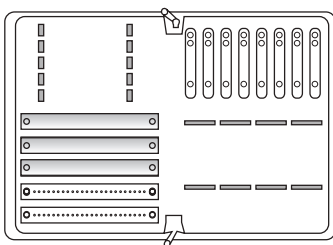

77-C3

Combination Style with Foam Pad Insert

Jewel-Folio Necklace Organizer

- * Black 7" x 7" pads each hold a 9" chain laid out or an 18" chain doubled.
- * Set includes velveteen folder and 4 pads.



BF-1001Y -BK

7 5/8" x 7 5/8"
(194 x 194mm)

Jewel-Folio Organizer

- * Fold the book to create a protective box for travel.
- * A clear vinyl label pocket on the side.

FD-7721 -BK

2 5/8" x 6" x 9" H
(67 x 152 x 228mm)



Black Leatherette Folders

- * Features removable vinyl covered foam insert.
- * Black leatherette exterior and black velvet interior.



Closed: 10" x 14" (254 x 357mm)

70-C1

Chain-16 Snaps
with Foam Pad Insert

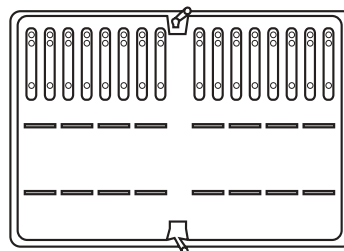

72-C1

Earring-250 Pr.
with Foam Pad Insert

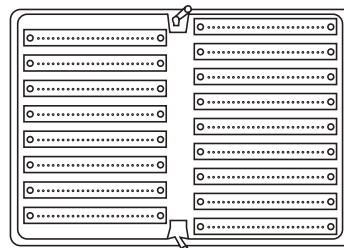

73-C1

Ring-10 Tubes

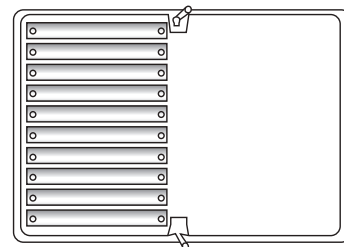

77-C1

Combination
with Foam Pad Insert

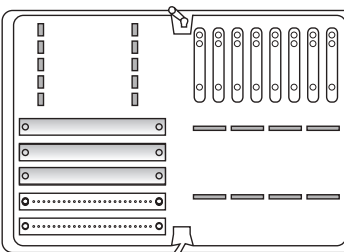

70-1C1

Watch/Bracelet
-20 Sections
with Foam Pad Insert

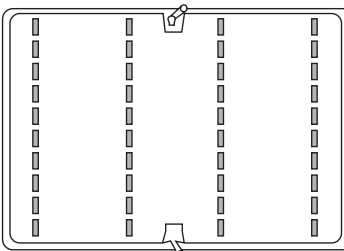

Vinyl Jewelry Rolls

Open: 11" x 22" (279 x 559mm)

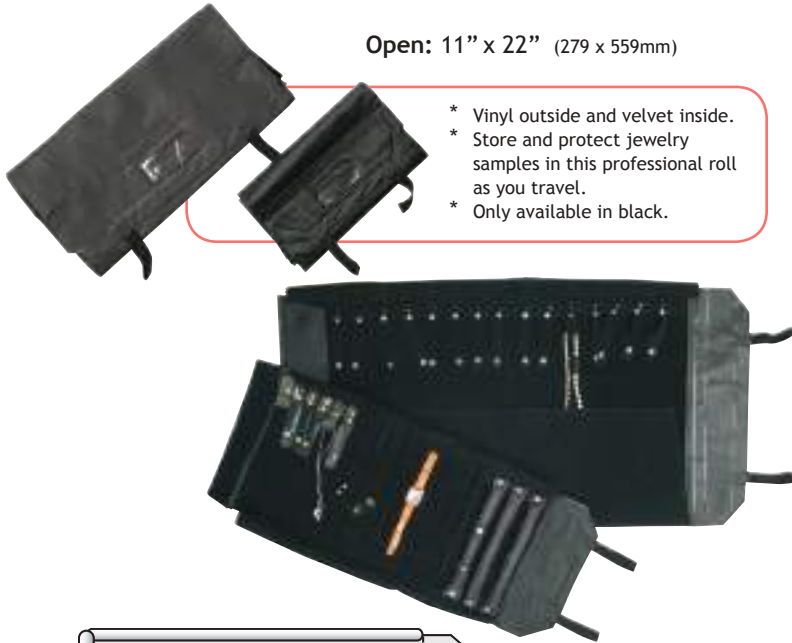

- * Vinyl outside and velvet inside.
- * Store and protect jewelry samples in this professional roll as you travel.
- * Only available in black.

Presentation Folder Collection

190

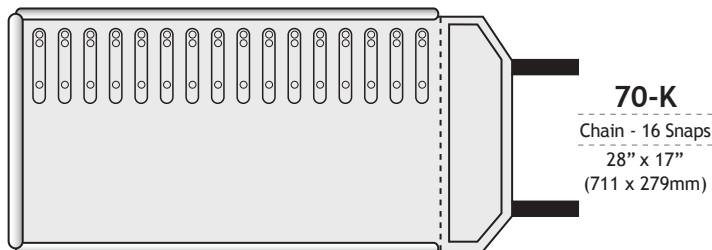
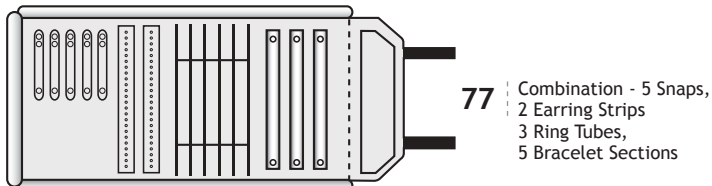
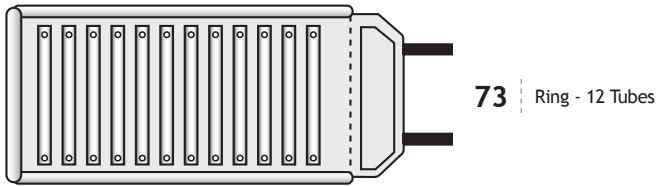
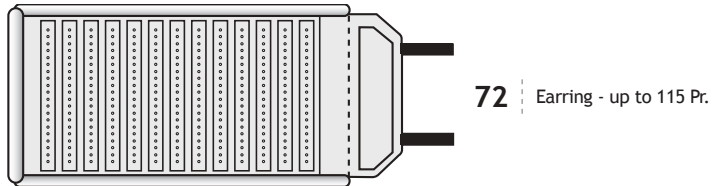
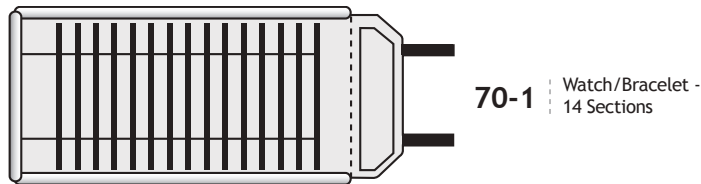
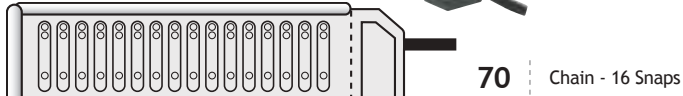

Gem File Card Organizers

* Gem cards are not included.



Security Wallets



Security Wallets

- * Can hold parcel papers up to size 3 1/4" x 2" (82 x 50mm)
- * Parcel papers are not included



Deluxe Velvet Jewelry Rolls

Open: 9 1/4" x 23 1/2" (235 x 597mm)

Available Colors



Black/Black
-BB



Black/Red
-BR



* Soft durable deluxe velvet interior and exterior with label window.

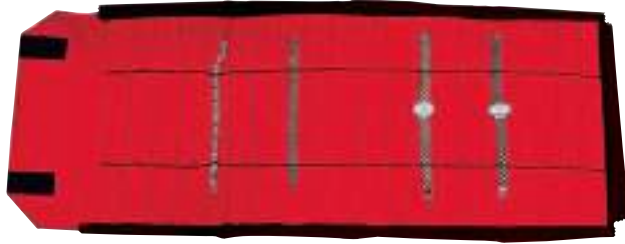

KR711V -Color

Combination :
Chain 6 Snaps, Earring
40 Pr., Bracelet 5 Sections,
Ring 5 Tubes

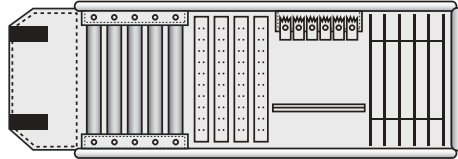

ER713V -Color

Earring
- 140 Pr.

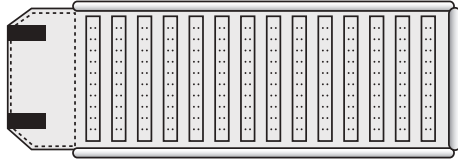

WR714V -Color

Watch/Bracelet
- 20 Sections

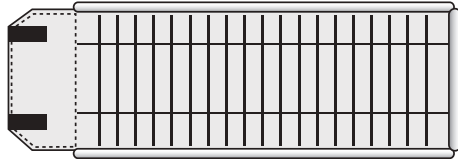

RR712V -Color

Ring
- 16 Ring Tubes

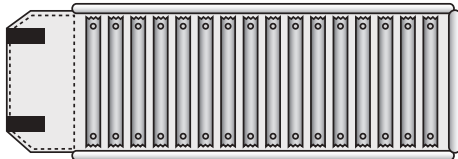

CR715V -Color

Chain
- 20 Snaps

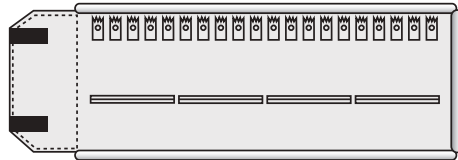

CR725V -Color

Chain (Long)
- 16 Snaps
15 1/2" x 23 1/2"
(394 x 597mm)

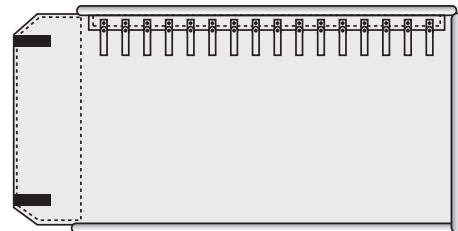

Black Velvet Jewelry Rolls

Open: 9 1/2" x 23 1/2" (241 x 597mm)

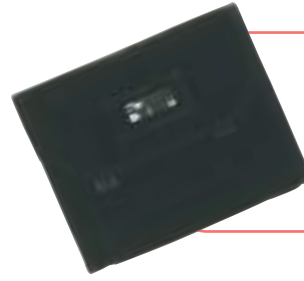

* Economical way to transport and present jewelry. The exterior and interior are black velvet with label window.



70-D3

Chain - 16 Snaps

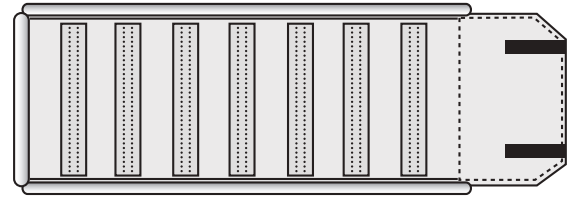

72-D3

Earring - 105 Pr.



77-D3

Combination - Chain 6 Snaps, Earring 26 Pr.,
Bracelet 5 Sections, Ring 3 Tubes



70-1D3

Watch/Bracelet - 14 Sections

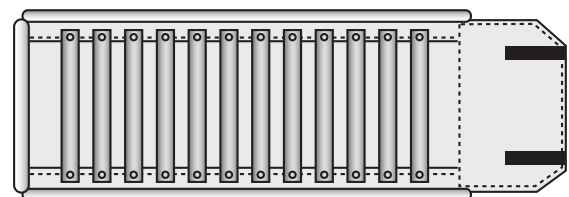

73-D3

Ring - 12 Ring Tubes

Ostrich Pattern Faux Leather Folders

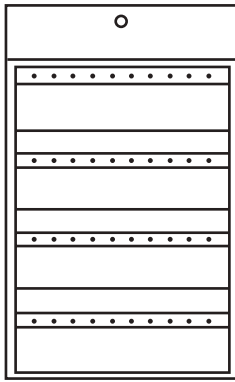

73-2P (BK)
16-Pr. Earrings w/Tube
3 3/8" x 8" x 3 3/8" D
(86 x 203 x 86mm)

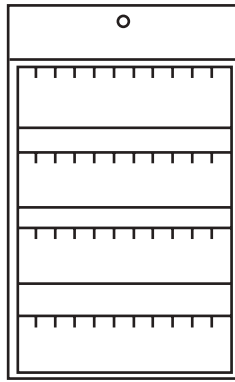

71-Q (BK)
20-Pendants w/Tube
3 1/4" x 10 1/4" x 3 1/4" D
(82 x 260 x 82mm)

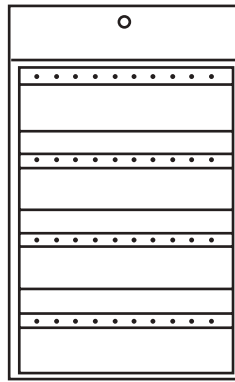

72-Q (BK)
20-Pr. Earrings w/Tube
3 1/4" x 10 1/4" x 3 1/4" D
(88 x 260 x 82mm)

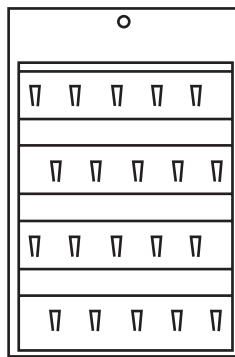

73-Q (BK)
20-Rings (Clip)
2 1/2" x 8" x 2 1/2" D
(63 x 203 x 63mm)

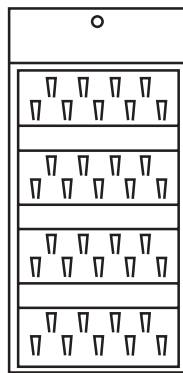

73-Q2 (BK)
36-Rings (Clip)
3" x 8" x 3" D
(76 x 202 x 76mm)

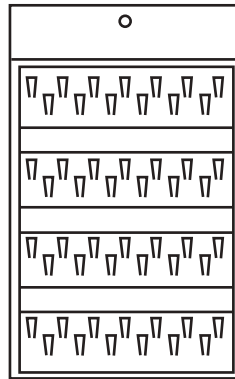

73-Q3 (BK)
52-Rings (Clip)
3 1/4" x 10 1/4" x 3 1/4" D
(82 x 260 x 82mm)



Embossed Ostrich pattern faux leather folder with white faux leather interior.



Embossed Ostrich Pattern

Presentation Folder Collection

192

Carbon Fiber Pattern Faux Leather Folders



Carbon Fiber Pattern

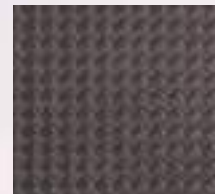

Carbon fiber pattern faux leather folder with white faux leather interior.

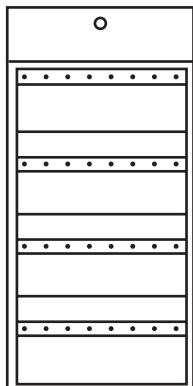

FD-7322L -BK
16-Pr. Earrings w/Tube
3 1/2" x 8" x 3 1/2" D
(89 x 203 x 89mm)

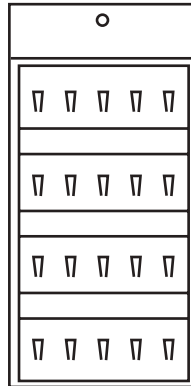

FD-7331L -BK
20-Rings (Clip)
3" x 8 3/8" x 3" D
(76 x 213 x 76mm)

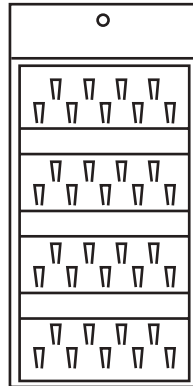

FD-7335L -BK
36-Rings (Clip)
3 1/2" x 8" x 3 1/2" D
(89 x 203 x 89mm)

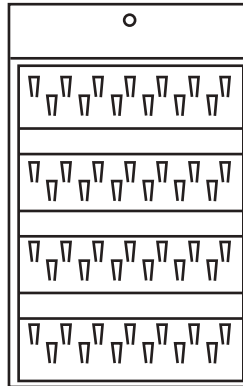

FD-7333L -BK
52-Rings (Clip)
3 1/2" x 10 1/4" x 3 1/2" D
(89 x 260 x 89mm)



Slot Ring Tray Cases



Black case with black insert.



89-R (BK)
12-Ring Case
8 1/4" x 3 1/2" x 1 5/8" H
(212 x 89 x 42mm)

88-R (BK)
24-Ring Case
8 3/4" x 5 1/4" x 1 5/8" H
(222 x 132 x 42mm)

84-R (BK)
36-Ring Case
8 1/4" x 7 3/8" x 1 5/8" H
(211 x 186 x 42mm)

83-R (BK)
72-Ring Case
14 3/4" x 8 1/4" x 1 5/8" H
(375 x 208 x 42mm)

Ultra Lightweight Display Folders

Folder Size : 8 1/2" x 7 1/2" x 1 1/2" H (216 x 191 x 38mm)



12 Pads



FD-2024-BK

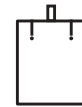

12 Pads



FD-2025-BK



Fold and Store

- * Lightweight display folders are both practical and functional.
- * Clear Label Holder on the side.



2 Pads



FD-2042-BK



17 Rings



FD-2045-BK

Wooden Jewelry Tray Cases

Closed Size: 10" x 6" x 2" H (254 x 152 x 51mm)



RC-1011W -Color
15-Jewelry Slots



RC-1012W -Color
15 Pr.-Earrings



RC-1013W -Color
8-Pendant/Earrings



RC-1014W -Color
8 Pr.-Earrings and Ring Combo



RC-1015W -Color
6-Bracelets



RC-1018W -Color
8 Pr.-Earrings

Available Colors

Rosewood Style
with White
Faux Leather
-RW



Vintage Style with
Chestnut Suede
-54



Deluxe Ring Cases



- * Perfect size for safe box.

RC8501L -BK
6 (Clip)

5 1/2" x 4 3/8" x 2" H
(140 x 111 x 51mm)

Ring Case with Removable Lid



RC-1101 -BK
7-Ring Tubes

8 1/4" x 7 5/8" x 2" H
(210 x 194 x 51mm)

■ Glass Top Ring/Cufflink Case

* Soft black faux leather with black velvet lining



NEW

RC-1017L-BK

9-Ring Slots

11 1/2" x 8 7/8" x 2 1/2" H
(29.2 x 20 x 6.3cm)

■ Glass Top Rosewood Ring/Cufflink Case

* Glossy rosewood finish with white faux leather lining



NEW

RC-2292W-RW

9-Ring Slots

13 3/4" x 8 5/8" x 2 7/8" H
(35 x 22 x 7.3cm)

■ Glass Top Jewelry Organizer

JB-3055-Color

8-Slots/7 Compartments

11 5/8" x 8" x 7 1/4" H
(29.5 x 20 x 18cm)



NEW

JB-3050-Color

8-Slots/5 Compartments

11 5/8" x 8" x 3 1/4" H
(29.5 x 20 x 9.5cm)



NEW

Available Colors

Black Faux
Leather Case
w/ Black Velvet
Interior
-BK

Black Carbon
Fiber Pattern
Case
w/ Black Velvet
Interior
-PT

Presentation Folder
Collection

194

■ Glass Top Jewelry Case

* Soft Black Carbon Fiber Pattern Exterior, 1 Jewelry Pouch, 1 Pendant/Earring Pad, 2 Slotted Sections, 5 Watch Pillows



NEW

WC-2291P-NV

Navy Suede Sections

13 3/4" x 8 5/8" x 2 7/8" H
(35 x 21 x 7.3cm)



NEW

WC-2291P-BK

Black Suede Sections

13 3/4" x 8 5/8" x 2 7/8" H
(35 x 21 x 7.3cm)

■ Econo Large Jewelry Attachè Case

- * The case includes: multiple chain snaps, removable slotted ring tray, 3-tiered earring pad, and 2 velvet pads.
- * Comes with 3 digit combination locks.



AC-1L3
14 7/8" x 14 7/8" x 3 1/2" H
(38 x 38 x 9cm)

■ Combination Folder

- * Both have a strap and snap to close.
- * Black soft faux leather with black velvet interior



Closed Size: 14" x 10" x 1 3/4" H
(356 x 254 x 44mm)

FD-7711
All Black Faux leather
FD-7711 -ZR
Zebra Pattern trim

■ Econo Jewelry Cases

- * Includes: chain snaps, ring sections, and 2 pads.
- * Comes with lock and key.



AC-1L
12 1/8" x 8 1/2" x 2 1/4" H
(31 x 21.5 x 6cm)

■ Econo Jewelry Attachè Case

- * Includes: chain snaps, removable slotted ring tray, and 2 velvet pads.
- * Features a 3-digit combination lock.



AC-1L2
8 1/2" x 12 1/8" x 2 1/4" H
(21.5 x 31 x 6cm)

Salesman's Organizer
Collection

195

■ Foldable Hard-Shell (Light Weight) Carrying Cases

Foldable Design

- * 3 digit combination locks.
- * Ship flat, space saving desgin.
- * Easy access drop down door.
- * Fit standard full size trays.
- * Tray sold separately.



860-2A
Holds 16 Pcs of 1" H Trays
16" x 8 1/2" x 17" H
(40.5 x 21.5 x 43cm)



860-3A
Holds 12 Pcs of 1" H Trays
16" x 8 1/2" x 14" H
(40.5 x 21.5 x 35.5cm)



860-4A
Holds 9 Pcs of 1" H Trays
16" x 8 1/2" x 9" H
(40.5 x 21.5 x 22.5cm)

Jewelry Attachè Case

- * The case includes: multiple chain snaps, removable slotted ring tray and 2 velvet pads.
- * Features a 3-digit combination lock.

82-AK
Black



82-AL
Silver

8 1/2" x 12" x 3 1/8" H
(22 x 31 x 8cm) Removable tray

- * The case includes: multiple chain snaps, removable slotted ring tray, 3-tiered earring pad, and 2 velvet pads.
- * Comes with 3 digit combination locks.

81-AK
Black



81-AL
Silver

15 1/4" x 15 1/4" x 3 1/4" H
(39 x 39 x 8cm)

Glass-Top Case

- * Comes with lock and key.
- * Jewelry pad not included



Case Size:
14 7/8" x 8 3/8" x 2 1/8" H
(38 x 21 x 6cm)

AL831C
Silver

AL831K
Black

Glass-Top Attachè Cases

- * Comes with 3 digit combination locks.
- * Includes protective side-panels.



AL810
15 1/4" x 15 1/4" x 3 1/8" H
(39 x 39 x 8cm)

Protective side-panels

Glass-Top Cases with Security Side Panel

- * Sturdy latch closures.
- * Case includes protective side panel.



The clear side panels on this case protect valuable jewelry items.
Can be used with display pad, pad sold separately.

AL813
24" x 20" x 3" H
(61 x 51 x 8cm)



AL819
34" x 22" x 3" H
(86 x 56 x 8cm)

Counter-Top Display Cases

- * Each case features tempered glass, sliding doors, key lock, and radius-edge frame.
- * Fully Assembled



A. F-1301

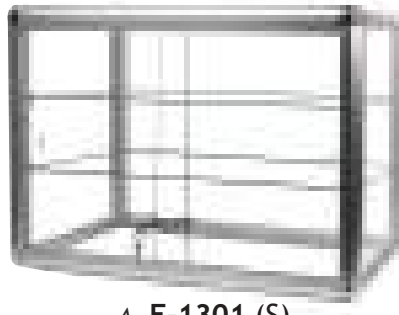

Glass Bottom A. F-1301 (S)



C. F-1303

Glass Bottom



B. F-1302



Mirror Bottom

B. F-1302 (S)



C. F-1303 (S)

	Champagne Tone	Silver Tone	Size: L x W x H	(cm)
A.	F-1301	F-1301 (S)	24" x 12" x 18"	(61 x 31 x 46)
B.	F-1302	F-1302 (S)	14" x 12" x 27"	(36 x 31 x 69)
C.	F-1303	F-1303 (S)	30" x 18" x 9"	(76 x 46 x 23)

Stackable Trunk w/wheels

Stacking Wheel Plates

Sturdy handles

AL863

31 1/2" x 18" x 14" H
(80 x 45.7 x 35.6cm)

Reinforced Corner



Recessed locking catch



* Sturdy ball bearing rolling wheels.

* Stackable



* Fully lined interior.



* 40 trays fit in the spacious trunk



* Accepted by most carriers.

Reinforced Corners Cases with Retractable Handles

NEW



* U.S. Patent D521,730



- * Features retractable handle
- * Side pocket inside door for storage
- * Wheels on back for easy rolling
- * Perfect for private jewelry showing and home parties.
- * Tray sold separately.

16 3/8" x 11" x 31 5/8" H
(41.5 x 27.8 x 74cm)



16 3/8" x 11" x 17" H
(41.5 x 27.8 x 43cm)

AL-8617-SW

Side Access
Holds 12 Pcs of 1" H Tray

AL-8627-SW

Side Access
Holds 24 Pcs of 1" H Tray



Heavy Duty Rolling Cases



* U.S. Patent D521,730

* Trays sold separately



861-7
Side Access
Holds 12 Pcs of 1" H Tray

16 3/8" x 10 1/2" x 28 1/2" H (41.5 x 23.8 x 66cm)



862-7
Side Access
Holds 24 Pcs of 1" H Tray



862-8
Front Access
Holds 24 Pcs of 1" H Tray

Front Access Black Rolling Case

16" x 9 1/2" x 17 1/2" H (40.6 x 24.1 x 44.5cm)



3 Digit combination lock.



Retractable handle



Please refer to Standard Display Tray Collection for more full size tray options.



AL865K

Holds 14 Pcs of 1" H Tray

Travel Rolling Case

16 3/8" x 11 1/2" x 15 1/2" H (41.6 x 29.2 x 39.4cm)

* U.S. Patent D521,730



Foam Lining



Net pocket to stay organized



3-digit combination locks



Please refer to Standard Display Tray Collection for more full size tray options.

Silver Trim



861-7B

Silver Trim / Side Access



Holds 12pcs of 1" H Tray

861-8B

Silver Trim / Front Access

Black Trim



861K-7B

Black Trim / Side Access



Holds 12pcs of 1" H Tray

861K-8B

Black Trim / Front Access

Salesman's Organizer
Collection

199

■ Angle Glass-Top Case w/Pullout Tray

- * Displays at a slight angle for better viewing.
- * Two drawers underneath for extra storage.
- * Pad included.



811-2
16 1/2" x 15" x 4 1/2" H
(42 x 38 x 11.5cm)

■ Glass-Top Display Cases for Trays

- * Fits two standard full-size trays. Trays sold separately.



817
18 1/8" x 15 5/8" x 3" H
(46 x 40 x 7.5cm)

■ Single-Side Cases with Glass-Top Panel



811-1
16 1/4" x 15" x 2 1/8" H
(41 x 38 x 6cm)



813-1
24" x 20" x 3" H
(61 x 20 x 8cm)



815-1
30" x 17 1/2" x 3" H
(76 x 45 x 8cm)

■ Double-Sided Cases with Glass-Top Panel



816
30" x 17 1/2" x 3" H/side
(76 x 45 x 8cm)



814
24" x 20" x 3" H/side
(61 x 51 x 8cm)



812
16 1/4" x 15" x 2 1/8" H/side
(41 x 38 x 6cm)

Pair of locks secure both cases together.



- * This double-sided case provides ample display and storage for trade shows.
- * Each half is a hinged case with a glass panel.
- * The case halves can be displayed separately or hinged together.

Display Pads for Glass-Top Travel Cases

Display Pads

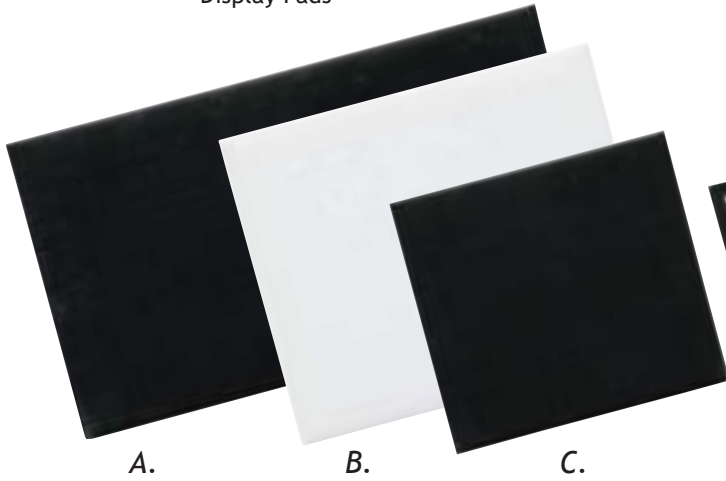

Display Pads w / Snaps

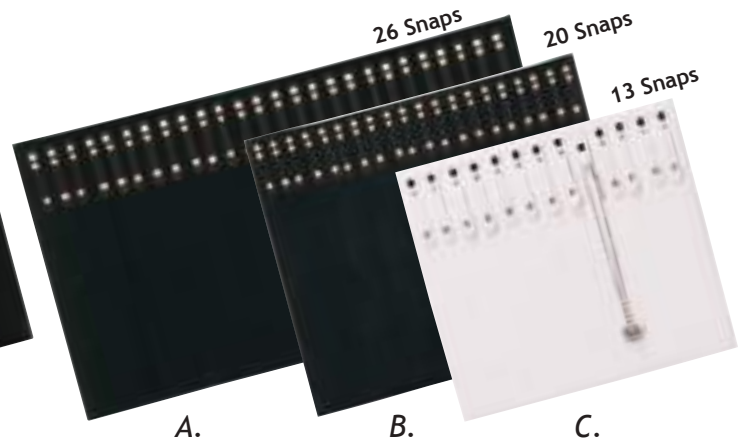

	Size: W x H (cm)	Compatible Case	No Snap Pad		With Snap	
			Black Velvet	White Leatherette	Black Velvet	White Leatherette
A.	29 1/2" x 16 3/4" (75 x 43)	815-1 or 816	93-C1 (BK)	93-C1L (W)	93-F1 (BK)	93-F1L (W)
B.	23 1/2" x 19 1/2" (60 x 50)	813-1 or 814	93-C2 (BK)	93-C2L (W)	93-F2 (BK)	93-F2L (W)
C.	15 1/2" x 14" (39 x 36)	811-1, 811-2 or 812	93-C3 (BK)	93-C3L (W)	93-F3 (BK)	93-F3L (W)

Foldable Black Velvet Pads for Glass-Top Cases

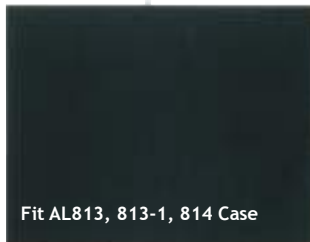

Fit AL813, 813-1, 814 Case

93-C4Y (BK)

Black Velvet

23 1/8" x 19 1/4" (59 x 49cm)



Fit AL819 Case

93-C5Y (BK)

Black Velvet

33" x 20 7/8" (84 x 53cm)

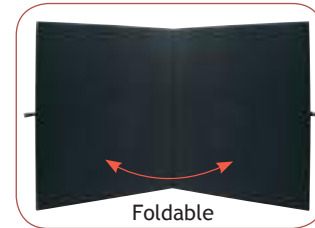
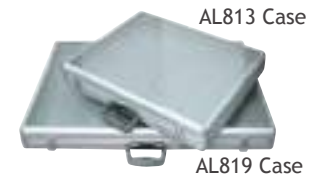

Foldable

Foldable Loop Fabric Pads for Glass-Top Cases

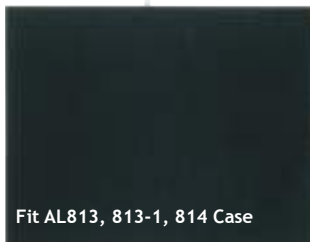

Fit AL813, 813-1, 814 Case

MP93C4 -Color

23 1/8" x 19 1/4" (59 x 49cm)



Fit AL819 Case

MP93C5 -Color

33" x 20 7/8" (84 x 53cm)

Available Colors



Black Loop Fabric
-BK

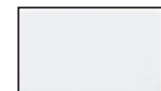

White Loop Fabric
-WH



Attach velcro to loop material.

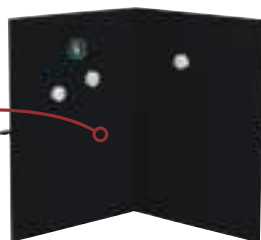

Loop Fabric - With loop fabric pads, you can securely mount and easily rearrange jewelry.



Foldable

Premium Fabric Soft Carrying Cases

- * Extra durable, water resistant fabric.
- * Suggested tray size: up to 14 3/4" x 8 1/4".
- * Trays sold separately.

Extra feature for 91-B2. Allows for easy loading to any handle.



Side Load



91-B2
Holds 12 Pcs of 1" H Trays
16" x 9" x 13 1/2" H
(41 x 23 x 34cm)

Front Load



Non-slip/clip-on shoulder strap

Features a large deep outside pocket.

91-C2
Holds 15 Pcs of 1" H Trays
16" x 9" x 16" H
(41 x 23 x 41 cm)

Side Load



91-A2
Holds 17 Pcs of 1" H Trays
16" x 9" x 19" H
(41 x 23 x 48 cm)

Soft Carrying Cases

- * Made with water resistant grey fabric.
- * Suggested tray size: up to 14 3/4" x 8 1/4".
- * Trays sold separately.



NEW

Side Load

91-B3
Holds 12 Pcs of 1" H Trays
16" x 9" x 13 1/2" H
(41 x 23 x 34cm)



NEW

Front Load

91-C3
Holds 15 Pcs of 1" H Trays
16" x 9" x 16" H
(41 x 23 x 41cm)

Features a large deep outside pocket.

Non-slip/clip-on shoulder strap



NEW

Side Load

91-A3
Holds 17 Pcs of 1" H Trays
16" x 9" x 19" H
(41 x 23 x 48cm)

Salesman's Organizer Collection

202

Soft Backpack for Trays

91-R

Holds 13 Pcs of 1" H Trays
15 1/4" x 9" x 14" H
(39 x 23 x 36cm)



Deluxe Soft Carrying Duffle Bags



- * Extra thick padding and extra compartments.
- * Suggested tray size: up to 15 7/8" x 9 1/2".
- * Available in black only.
- * Front drops down to make trays easily accessible.
- * Trays and inserts are available separately.

1 exterior pockets



91-H
Holds 10 Pcs of 1" H Trays
16" x 9 1/2" x 11" H
(41 x 24 x 28cm)

2 exterior pockets



91-G
Holds 12 Pcs of 1" H Trays
16" x 9 1/2" x 12 1/2" H
(41 x 24 x 32cm)

■ Sky Grey Collapsible Rolling Cases w/ Handle

- * Water resistant sky grey color fabric with padded interior.
- * Suggested tray size: up to 14 3/4" L x 8 1/4" W.



91-5B
 Holds 12 Pcs of 1" H Trays
 16" x 9" x 13 1/2" H
 (41 x 23 x 34 cm)



Side opens to make trays easily accessible. Tray sold separately.

Wheels for easy pulling.

Space saver. Fold Flat for easy Storage.



91-5A
 Holds 17 Pcs of 1" H Trays
 16" x 9" x 19" H
 (41 x 23 x 48 cm)

■ Collapsible Rolling Cases with Handle

- * Water resistant black fabric with padded interior.
- * Suggested tray size: up to 14 3/4" L x 8 1/4" W.



With wheels in the back

91-4B
 Holds 12 Pcs of 1" H Trays
 16" x 9" x 13 1/2" H
 (41 x 23 x 34cm)



Space saver. Fold flat for easy storage.

Side opens to make trays easily accessible. Tray sold separately.



91-4A
 Holds 17 Pcs of 1" H Trays
 16" x 9" x 19" H
 (41 x 23 x 48cm)

6-Tray Wooden Organizer

- * All new wooden tray organizer made with an earthy, natural wood material.
- * Each tray is 1 1/2" H, 6 trays total with charming wooden fixtures.



- * Full size pad fits into each tray.
- * DP-9301N-N3 pad sold separately.



DP-9301N-N3



TY-8816-NW
16" x 9" x 11 3/4"
(41 x 23 x 30 cm)

Wooden Burlap / Linen Utility Tray



Available Colors



Linen
N-LE

Burlap
N-N3



* Pad sold separately



	Burlap	Linen	Size: W x H	(cm)
A.	TY-1220N-N3	TY-1220N-LE	7 1/4" x 8 1/4" x 1" H	(18.4 x 21 x 2.5)
B.	TY-1221N-N3	TY-1221N-LE	14 3/4" x 8 1/4" x 1" H	(37.5 x 21 x 2.5)
C.	TY-1222N-N3	TY-1222N-LE	14 3/4" x 8 1/4" x 1 1/2" H	(37.5 x 21 x 3.8)

Salesman's Organizer Collection

204

Stackable Wooden Display Tray

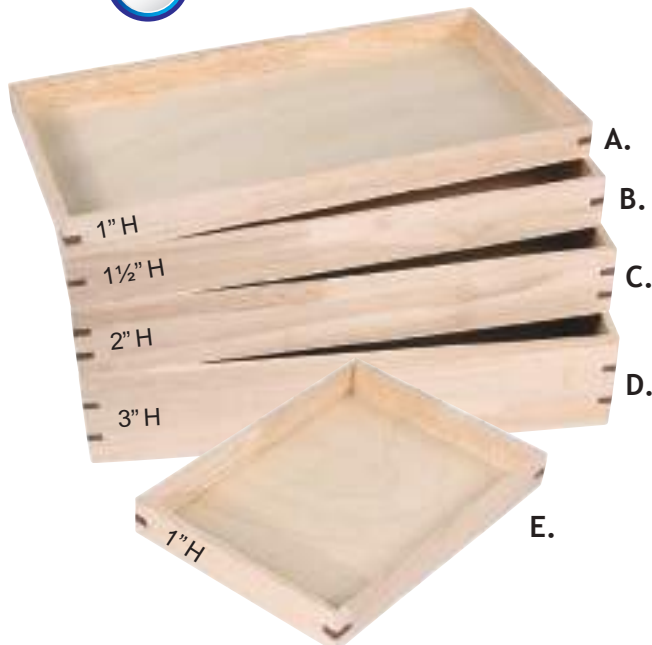

	Item	Size: W x D x H	(cm)
A.	TY-1321-NW	15" x 8 1/2" x 1"	(38 x 21.5 x 2.5)
B.	TY-1322-NW	15" x 8 1/2" x 1 1/2"	(38 x 21.5 x 4)
C.	TY-1323-NW	15" x 8 1/2" x 2"	(38 x 21.5 x 6)
D.	TY-1324-NW	15" x 8 1/2" x 3"	(38 x 21.5 x 7.5)
E.	TY-1320-NW	7 1/2" x 8 1/2" x 1"	(19.1 x 21.5 x 2.5)
F.	DP-9301N-LE	14 1/8" L x 7 5/8" W	(36 x 19.5)
G.	DP-9301N-N3	14 1/8" L x 7 5/8" W	(36 x 19.5)



Burlap Antique Look Single-Side Case

* Protective Corner



NEW



CS-8113N-N3

Burlap Large Glass-Top Case

24" x 20" x 3" H
(61 x 20 x 8cm)



NEW

CS-8111N-N3

Burlap Glass-Top Case

16 1/4" x 15" x 2 1/8" H
(41.3 x 38.1 x 5.5cm)

Glass-Top Wooden Case

15 1/8" x 8 3/8" x 2 1/4" H (38.4 x 21.3 x 5.7cm)



NEW

DP-9301N-N3 Pad Sold Separately.



CS-8305W-NW

Natural Wood Glass-Top

Jewelry Case Organizer

Case Size: 14 3/4" x 8 1/4" x 2 1/8" H (37.5 x 21 x 5.4cm)

CS-8315N-N3

Burlap / Solid-Top

NEW



CS-8315N-LE

Linen / Solid-Top

CS-8305N-N3

Burlap / Glass-Top

DP-9301N-N3 Pad Sold Separately.



CS-8305N-LE

Linen / Glass-Top

5-Tray Organizers

- * Includes 5 - 1 1/4" H drawers
- * Drawers can hold any full-size insert.
- * Insert sold separately.



883 -1 (BK)
With Five 1 1/4" H Trays
15 1/8" x 8 3/8" x 7 5/8" H
(38.5 x 21 x 19cm)

6-Tray Organizer

- * A new tray organizer made with carbon fiber faux leather.
- * Includes six 1" H plastic trays.
- * Drawer can fit any full size pad.

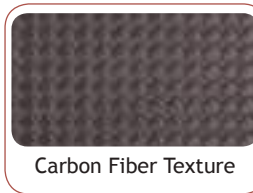

Carbon Fiber Texture



TY-8806-PT
With Six 1" H Trays
8 7/8" x 15" x 8 3/8" H
(22.5 x 38 x 21.5 cm)

1" H

10-Tray Organizer

- * Includes ten 1" H trays.
- * Drawers can fit most full-size pads or inserts.
- * Each drawer features a metal label pocket.
- * Inserts sold separately.



883 (BK)
With Ten 1" H Trays
8 1/2" x 14 5/8" x 16 1/4" H
(21.5 x 37.5 x 41.5 cm)

1" H

9-Tray Organizers



- * Includes nine 1 1/2" H trays
- * Drawers can fit most full-size pads or inserts.
- * Each drawer features a metal label pocket (label not included).
- * Inserts sold separately.



TY-8802-BK
With Nine 1 1/2" H Trays
8 1/2" x 14 5/8" x 16 1/4" H
(21.5 x 37.5 x 41.5 cm)

1 1/2" H

Travel Storage Organizer with Sample Trays

- * Features handle straps for easy transport.



- * Simply slide the tray out for presentation.



883-2T (BK)
* Replacement tray for 883-2 & 883-3
* Tray features viewing window lid.
14 3/4" x 8 1/4" x 1 1/2" H
(37.5 x 21 x 4cm)



883-2 (BK)
With 8 sample Trays
16" x 9" x 15 3/4" H
(41 x 23 x 40cm)



883-3 (BK)
With 10 sample Trays
16" x 9" x 19 1/2" H
(41 x 23 x 50cm)

■ Metal Clasps Lid Cases

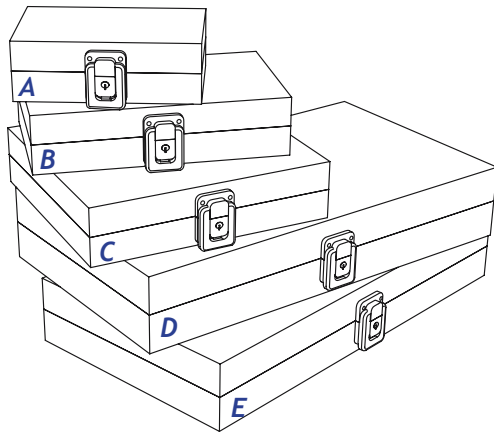

Metal Clasps Lid Case Sizes :

- | | |
|--|---|
| A 6" x 3 3/4" x 2" H
(15.2 x 9.5 x 5cm) | D 14 3/4" x 8 1/4" x 2 1/8" H
(37.5 x 21 x 5.5cm) |
| B 8 1/8" x 4 3/4" x 2" H
(21 x 12 x 5cm) | E 14 3/4" x 8 1/4" x 2 5/8" H
(37.5 x 21 x 6.7cm) |
| C 8 1/4" x 7 1/4" x 2" H
(21 x 18.5 x 5cm) | |



Glass Top Lid

	Item
A.	85-1C
B.	88-1C
C.	84-1C
D.	83-1C
E.	83-2C



Solid Top Lid

	Item
A.	85-1B
B.	88-1B
C.	84-1B
D.	83-1B
E.	83-2B

■ Black Leatherette Case



Leatherette Texture



Use with Tray Liner

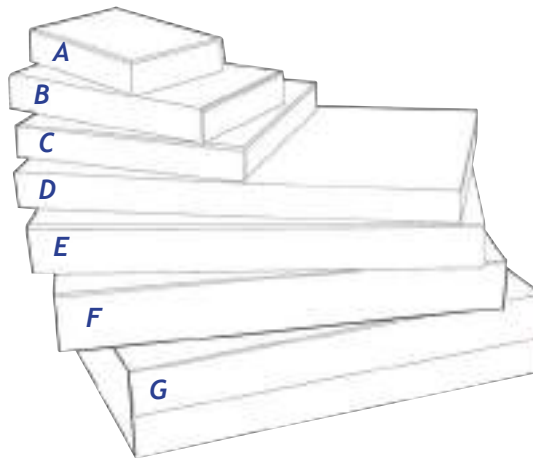

Attached Lid

All-Purpose Tray Case Sizes :

- | |
|---|
| A 6" x 3 3/4" x 1 1/8" H
(15.2 x 9.5 x 3cm) |
| B 8 1/4" x 4 3/4" x 1 1/8" H
(21 x 12 x 3cm) |
| C 8 1/4" x 7 1/4" x 1 1/8" H
(21 x 18.4 x 3cm) |
| D 14 3/4" x 8 1/4" x 1 1/8" H
(37.5 x 21 x 3cm) |
| E 14 3/4" x 8 1/4" x 1 1/2" H
(37.5 x 21 x 3.8cm) |
| F 14 3/4" x 8 1/4" x 2" H
(37.5 x 21 x 5cm) |
| G 14 3/4" x 8 1/4" x 3" H
(37.5 x 21 x 7.6cm) |



Snap-Close Acrylic Lid

	Item
A.	85-1D (BK)
B.	88-1D (BK)
C.	84-1D (BK)
D.	83-1D (BK)
E.	83-2D (BK)
F.	83-3D (BK)
G.	83-4D (BK)



Solid Top Snap-Close Lid

	Item
A.	85-1J
B.	88-1J
C.	84-1J
D.	83-1J
E.	83-2J
F.	83-3J
G.	83-4J

Detachable Lid



Detached Magnetic Lid

	Item
A.	85 (BK)
B.	88 (BK)
C.	84 (BK)
D.	83 (BK)
E.	83-1G (BK)
F.	83-2G (BK)
G.	83-3G (BK)



Detached Snap-Close Lid

	Item
A.	85-1K
B.	88-1K
C.	84-1K
D.	83-1K
E.	83-2K
F.	83-3K
G.	83-4K

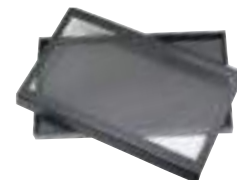

Detached Magnetic Acrylic Lid

	Item
A.	85-1F (BK)
B.	88-1F (BK)
C.	84-1F (BK)
D.	83-1F (BK)
E.	83-2F (BK)
F.	83-3F (BK)
G.	83-4F (BK)

■ Nesting Plastic Trays

TY-1021-BK
14 3/4" x 8 1/4" x 1" H
(37.5 x 21 x 2.5cm)

Full Size Tray

1" H
1 1/2" H

TY-1022 -BK
14 3/4" x 8 1/4" x 1 1/2" H
(37.5 x 21 x 4cm)



This tray is incredibly easy to stack and the side grooves make moving trays a breeze.

Texture

Rounded Corners



Tray insert sold separately



Ask about our soft carrying cases. Fits 10 trays.



Plastic feet allow stable and secure stacking. Easy moving and sturdy.

Standard Display Tray Collection

208

■ Acrylic Top Lid Cases

83-1E (BK)
15 1/4" x 8 3/4" x 1 1/4" H
(39 x 22 x 3cm)

84-1E (BK)
8 3/4" x 7 3/4" x 1 1/4" H
(22 x 20 x 3cm)

Clear top keeps contents fully visible.

■ Double Clasp Lid Case



Features detachable hinge for easy access.

83-2A
14 3/4" x 8 1/4" x 2 1/4" H
(37.5 x 21 x 6cm)

■ Stackable Plastic Trays

14 3/4" L x 8 1/4" W (37.5 x 21 mm)

1-1P (Color)

1-2P (Color)

1-3P (Color)

1" H
1 1/2" H
2" H

1" H

* Stackable trays have plastic feet to allow stable, secure stacking.
* Fits most standard size inserts.

Available Plastic Colors:

White (W)

Black (BK)



2-1P (Color)
7 1/4" L x 8 1/4" W
(18.5 x 21 mm)

Standard Utility Trays Textured Leatherette



A. 1-1 (Color)

B. 1-2 (Color)

C. 1-3 (Color)

D. 1-4 (Color)

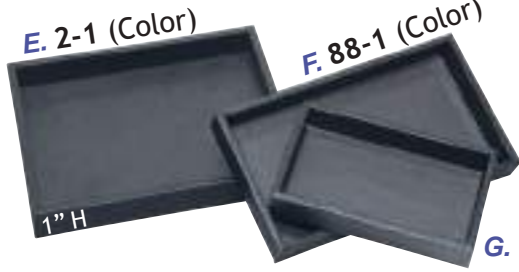

E. 2-1 (Color)

F. 88-1 (Color)

G. 85-1 (Color)

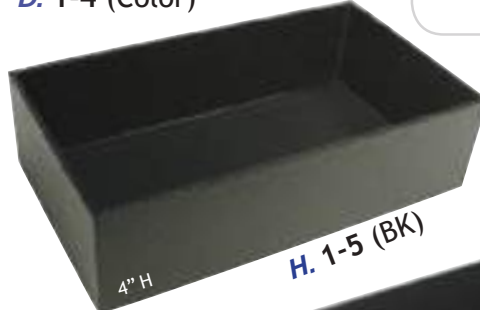

H. 1-5 (BK)

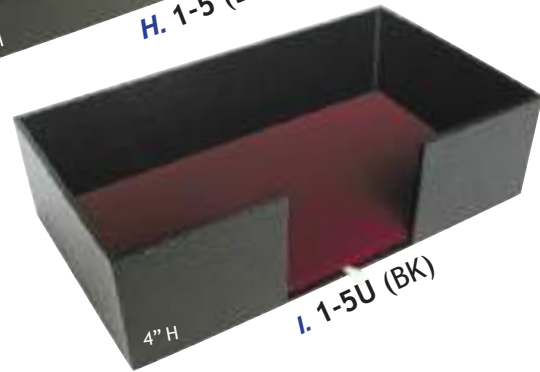

I. 1-5U (BK)

Available Colors:

Black
(BK)
Grey
(G)
White
(W)

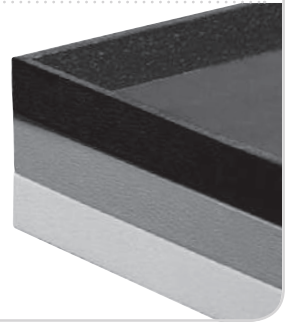

Item	Size: W x D x H (cm)
A. 1-1 (Color)	14 3/4" x 8 1/4" x 1" H (37.5 x 21 x 2.5)
B. 1-2 (Color)	14 3/4" x 8 1/4" x 1 1/2" H (37.5 x 21 x 4)
C. 1-3 (Color)	14 3/4" x 8 1/4" x 2" H (37.5 x 21 x 5)
D. 1-4 (Color)	14 3/4" x 8 1/4" x 3" H (37.5 x 21 x 7.5)
E. 2-1 (Color)	8 1/4" x 7 1/4" x 1" H (21 x 18 x 2.5)
F. 88-1 (Color)	8 1/4" x 4 3/4" x 1" H (21 x 12 x 2.5)
G. 85-1 (Color)	6" x 3 3/4" x 1" H (15 x 9.5 x 2.5)
H. 1-5 (BK)	14 3/4" x 8 1/4" x 4" H (37.5 x 21 x 10)
I. 1-5U (BK)	14 3/4" x 8 1/4" x 4" H (37.5 x 21 x 10)

* Features cutout for easy access to stacked pads.
* Insert pad not included.

Leatherette Stackable Tray

* Grooves on bottom and top of trays allow for secure stacking.

14 3/4" x 8 1/4" x 1 1/2" H
(37 x 21 x 4cm)



TY-1131

Black Leatherette Wood Tray

Wooden Stackable Trays

* Grooves on bottom and top of trays allow stable and secure stacking.

14 3/4" x 8 1/4" x 1 1/2" H
(37 x 21 x 4cm)

TY-1129
Rosewood
Finish



TY-1128-DW

Dark Walnut
Finish

Black Velvet Trays

* Well constructed wood tray covered with deluxe velvet.

14 3/4" x 8 1/4" (37.5 x 21cm)

1-1V (BK)

1" H (2.5cm) Tray

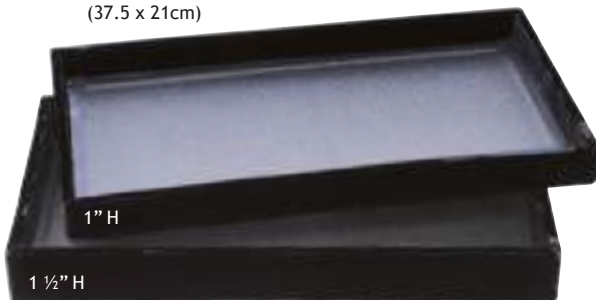

1-2V (BK)

1 1/2" H (4cm) Tray

Carbon Fiber Pattern Stackable Trays

* Tray insert pad sold separately.

14 3/4" x 8 1/4" (37.5 x 21cm)



TY-1111 -BK
1" H (2.5cm) Tray

TY-1112 -BK
1 1/2" H (4cm) Tray

TY-1113 -BK
2" H (5cm) Tray



Carbon Fiber Texture

Label slot makes organizing trays a breeze.

Econo Ring Foams

92-72B (Color)

72-Ring Slots
7 5/8" x 14 1/8"
(195 x 360mm)



92-72E (Color)

72-Ring Slots
14 1/8" x 7 5/8"
(360 x 195mm)

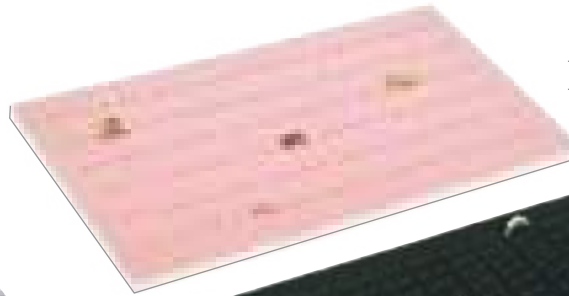

92-144E (Color)

144-Ring Slots
14 1/8" x 7 5/8"
(360 x 195mm)



92-36E (Color)

36-Ring Slots
7 3/4" x 6 3/4"
(197 x 170mm)



Available Econo Foam Colors:



Deluxe Ring Foams

92-72 (Color)

72-Ring Slots
14 1/8" x 7 5/8"
(360 x 195mm)



Available Deluxe Foam Colors:



92-36 (Color)

36-Ring Slots
7 3/4" x 6 3/4"
(197 x 170mm)



Continuous-Slot Ring Inserts

222-1 (Color)

14 1/8" x 7 5/8"
(360 x 195mm)



222-84 (Color)

7 3/4" x 6 3/4"
(197 x 170mm)



222-88 (Color)

7 1/2" x 4"
(190 x 102mm)



222-85 (Color)

5 1/2" x 3 1/8"
(137 x 79mm)



Fits in standard size tray;
Tray sold separately.

Available Colors



Wooden Full-Size Tray Liners

Tray Liner Size: 14 1/8" x 7 5/8" x 1/2" H (360 x 195 x 13mm)

* Fits in standard full-size tray.
Trays sold separately.

Faux Leather Colors:



White (W)



Black (BK)



8 Sections :

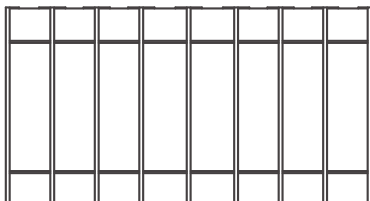

99-08BP (Color) | **99-08B (Color)**
Faux Leather | Velvet

10 Sections :

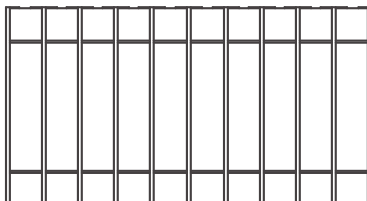

99-10BP (Color) | **99-10B (Color)**
Faux Leather | Velvet

12 Sections :

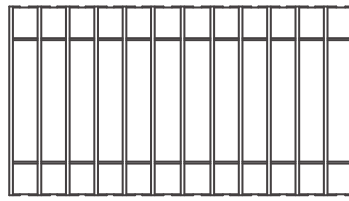

99-12BP (Color) | **99-12B (Color)**
Faux Leather | Velvet

Velvet Colors:



Grey (G)

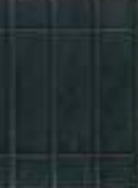

Black (BK)

15 Sections :

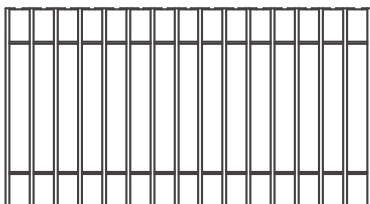

99-15BP (Color) | **99-15B (Color)**
Faux Leather | Velvet

12 Compartments :

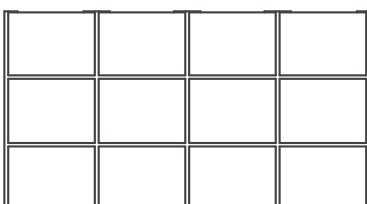

99-12P (Color) | **99-12 (Color)**
Faux Leather | Velvet

18 Compartments :

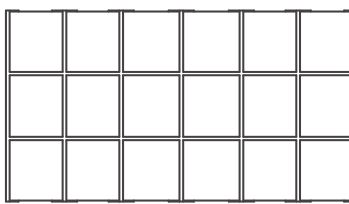

99-18P (Color) | **99-18 (Color)**
Faux Leather | Velvet

24 Compartments :

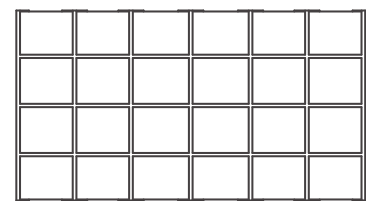

99-24P (Color) | **99-24 (Color)**
Faux Leather | Velvet

32 Compartments :

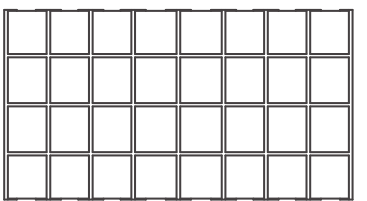

99-32P (Color) | **99-32 (Color)**
Faux Leather | Velvet

40 Compartments :

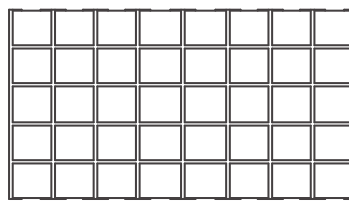

99-40P (Color) | **99-40 (Color)**
Faux Leather | Velvet

Tray Insert Collection

211

Wooden Half-Size Tray Liners

7 5/8" x 6 3/4" x 1/2" H (195 x 170 x 13mm)

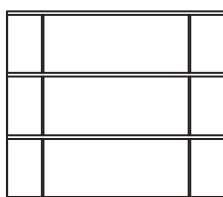
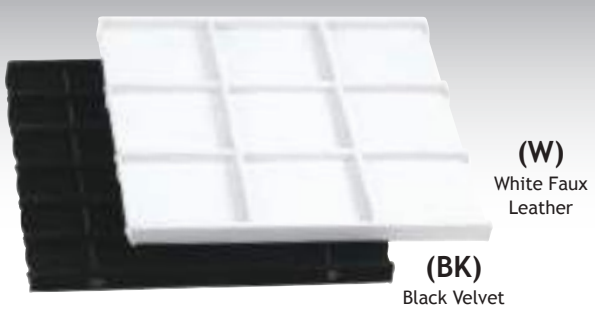

991-03BP (W)
991-03B (BK)

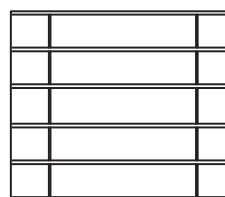

991-05BP (W)
991-05B (BK)

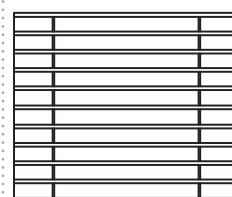

991-10BP (W)
991-10B (BK)

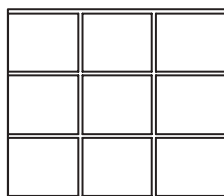

991-09BP (W)
991-09B (BK)

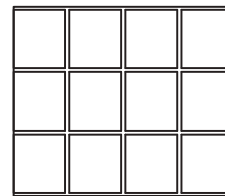

991-12P (W)
991-12 (BK)

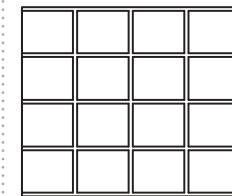

991-16P (W)
991-16 (BK)

Flocked Tray Liners

Tray Liner Size:

14 1/8" L x 7 5/8" W x 1/2" H
(360 x 194 x 13mm)

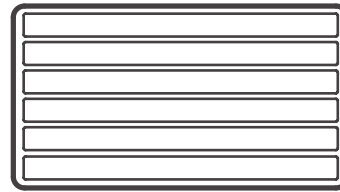

96-06 (Color)

Each Section: 1" x 13 1/2"

Available
Flocked Colors:

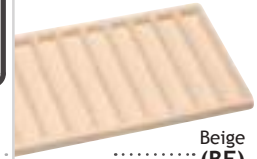

Beige
(BE)



Black
(BK)



Grey
(G)



Red
(R)



White
(W)

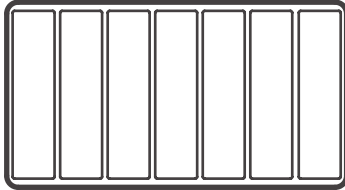

96-07 (Color)

Each Section: 1 3/4" x 7"

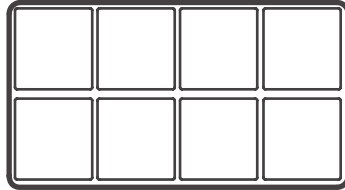

96-08 (Color)

Each Section: 3" x 3 1/4"

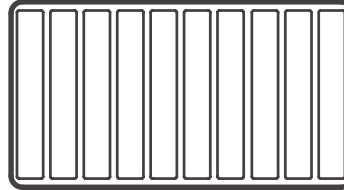

96-10 (Color)

Each Section: 1 3/16" x 6 3/4"

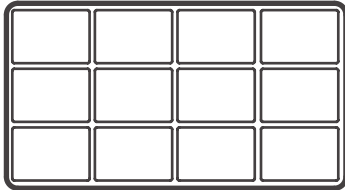

96-12 (Color)

Each Section: 3 1/4" x 2 3/8"

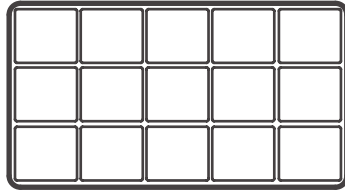

96-15 (Color)

Each Section: 2 9/16" x 2 1/4"

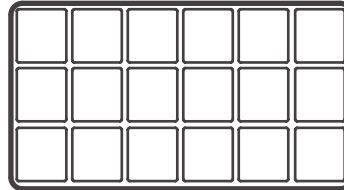

96-18 (Color)

Each Section: 2" x 2 1/4"

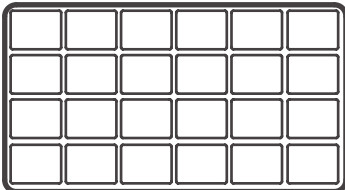

96-24 (Color)

Each Section: 2 1/8" x 1 3/4"

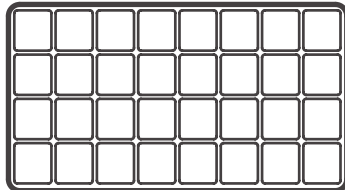

96-32 (Color)

Each Section: 1 5/8" x 1 3/4"

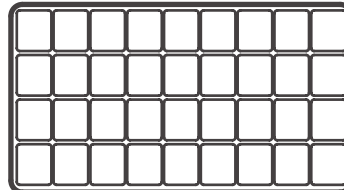

96-36 (Color)

Each Section: 1 1/2" x 1 3/4"

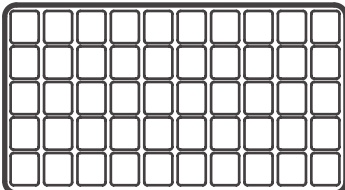

96-50 (Color)

Each Section: 1 1/8" x 1 1/4"

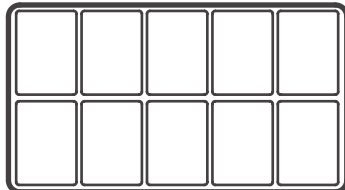

96-T1 (Color)

Each Section: 2 1/2" x 3 3/8"

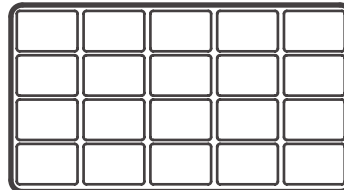

96-T2 (Color)

Each Section: 2 3/8" x 1 1/2"



* Ask us about our standard trays.
* Tray sold separately.

Flocked Tray Liners For Earrings

Tray Liner Size: 14 1/8" L x 7 5/8" W x 1/2" H (360 x 194 x 13mm)



96-38 (Color)

for 24 pr. of earring



96-28 (Color)

(fit 1 1/2" x 1 3/4" puff earring cards)

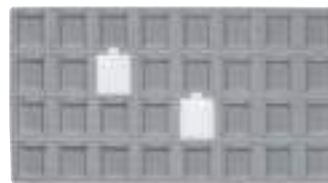

96-32E (Color)

(fit 1 1/2" x 1 3/4" puff earring cards)



96-50E (Color)

(fit 1" x 1" puff earring cards)

Flocked Half-Size Tray Liners

Tray Liner Size: 7 5/8" x 6 3/4" x 1/2" H (195 x 170 x 13mm)



* Fits in standard half-size tray.
* Trays sold separately.
* Available in black, white, and grey.

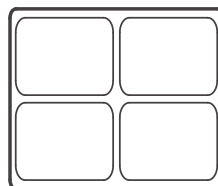

97-04 (Color)

Each Section: 3 3/8" x 2 7/8"

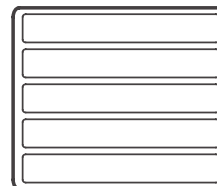

97-05 (Color)

Each Section: 7" x 1"

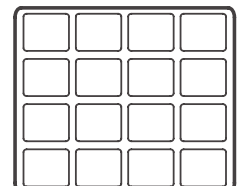

97-16 (Color)

Each Section: 1 5/8" x 1 3/8"



Durable Textured Plastic Tray Inserts

Tray Insert Size: 14 1/8" L x 7 5/8" W (360 x 195mm)

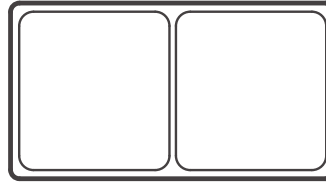

PT2 (Color)

Each Section:
6 1/2" x 6 7/8" x 1 3/8" H

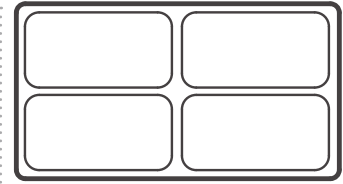

PT4 (Color)

Each Section:
6 3/8" x 3 1/4" x 1 3/8" H

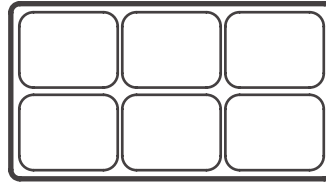

PT6 (Color)

Each Section:
4 1/4" x 3 1/4" x 1 3/8" H

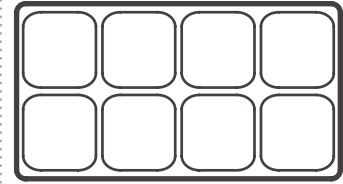

PT8 (Color)

Each Section:
3 1/8" x 3 3/8" x 1 3/8" H

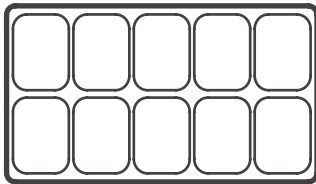

PT10B (Color)

Each Section:
2 1/2" x 3 1/4" x 1" H

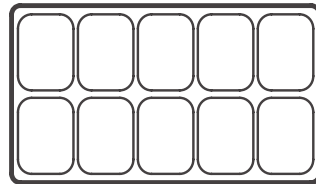

PT10C (Color)

Each Section:
2 1/2" x 3 1/4" x 1 3/8" H

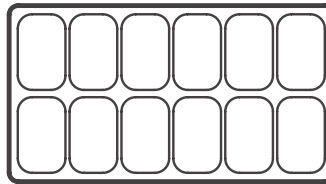

PT12 (Color)

Each Section:
2" x 3 1/4" x 1 3/8" H

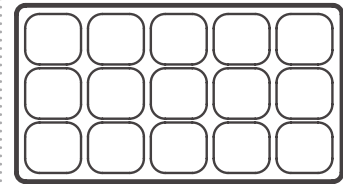

PT15 (Color)

Each Section:
2 3/8" x 2 1/8" x 1 3/8" H

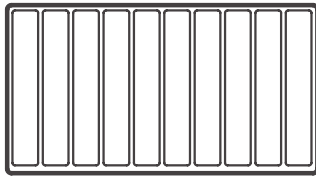

PT10A (Color)

Each Section:
1 1/8" x 7" x 1/2" H

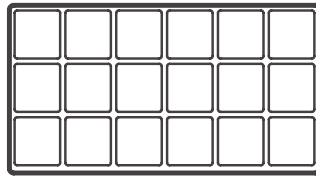

PT18 (Color)

Each Section:
2" x 2 1/8" x 1/2" H

Fit Puff Earring Cards:
BX595, BX535

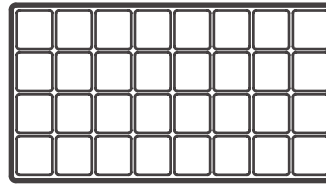

PT32 (Color)

Each Section:
1 1/2" x 1 5/8" x 1/2" H

Fit Puff Earring Cards:
EP01, EP02, EP03

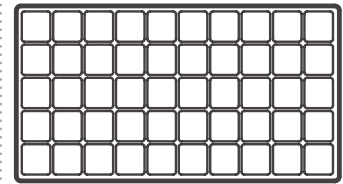

PT50 (Color)

Each Section:
1 3/16" x 1 1/4" x 1/2" H



Heavy-Duty Plastic Stackable Trays (Light-Weight)

Tray Size: 9 1/2" x 15 7/8" x 1 3/8" H (241 x 403 x 35mm)



PC1 (Color)

Each Section:
9" x 15 3/8"

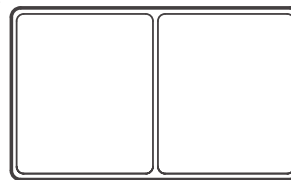

PC2 (Color)

Each Section:
9" x 7 5/8"

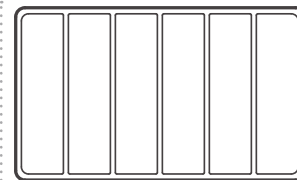

PC6 (Color)

Each Section:
9" x 2 3/8"

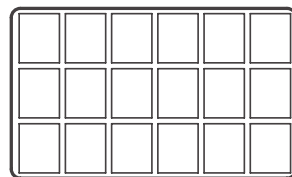

PC18 (Color)

Each Section:
2 3/4" x 2 3/8"

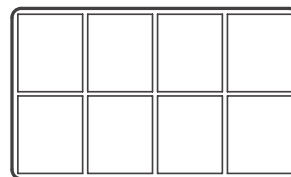

PC8 (Color)

Each Section:
4 3/8" x 3 5/8"

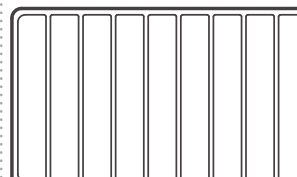

PC9 (Color)

Each Section:
9" x 1 1/2"

Oval Display Pads

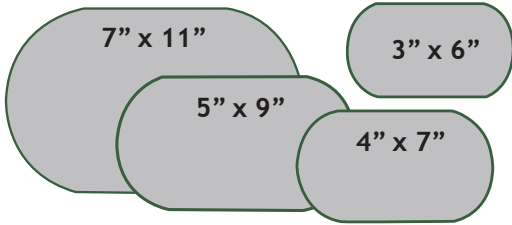
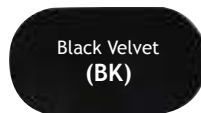
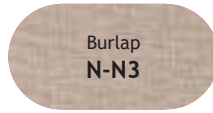

Size: W x H (mm)	Burlap	Linen	Black Velvet	White Faux Leather
7" x 11" (178 x 279)	DP-9351N-N3	DP-9351N-LE	351-1 (BK)	351-1L (W)
5" x 9" (127 x 229)	DP-9352N-N3	DP-9352N-LE	351-2 (BK)	351-2L (W)
4" x 7" (102 x 178)	DP-9353N-N3	DP-9353N-LE	351-3 (BK)	351-3L (W)
3" x 6" (76 x 152)	DP-9354N-N3	DP-9354N-LE	351-4 (BK)	351-4L (W)

Round Display Pads

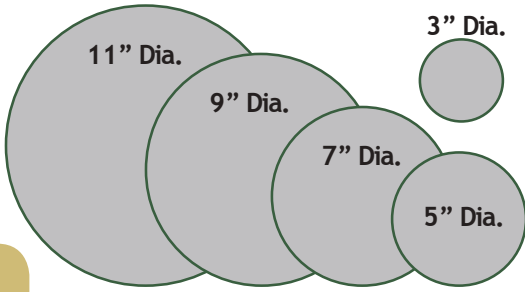

Size: Dia (mm)	Burlap	Linen	Black Velvet	White Faux Leather
11" (279)	DP-9319N-N3	DP-9319N-LE	319 (BK)	319L (W)
9" (229)	DP-9318N-N3	DP-9318N-LE	318 (BK)	318L (W)
7" (178)	DP-9317N-N3	DP-9317N-LE	317 (BK)	317L (W)
5" (127)	DP-9316N-N3	DP-9316N-LE	316 (BK)	316L (W)
3" (76)	DP-9315N-N3	DP-9315N-LE	315 (BK)	315L (W)

Triangular Display Pads

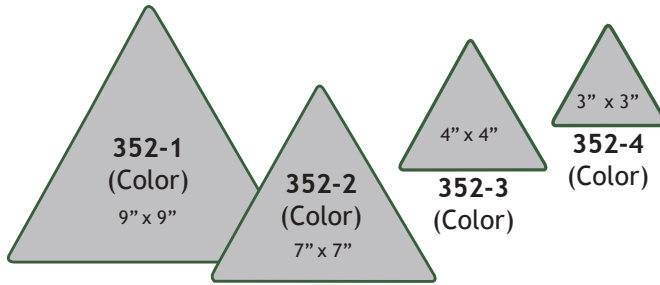

Size: W x H (mm)	Black Velvet	White Faux Leather	Black Faux Leather
9" x 9" (229 x 229)	352-1 (BK)	352-1L (W)	352-1L (BK)
7" x 7" (178 x 178)	352-2 (BK)	352-2L (W)	352-2L (BK)
4" x 4" (102 x 102)	352-3 (BK)	352-3L (W)	352-3L (BK)
3" x 3" (76 x 76)	352-4 (BK)	352-4L (W)	352-4L (BK)

Rectangular Display Pads

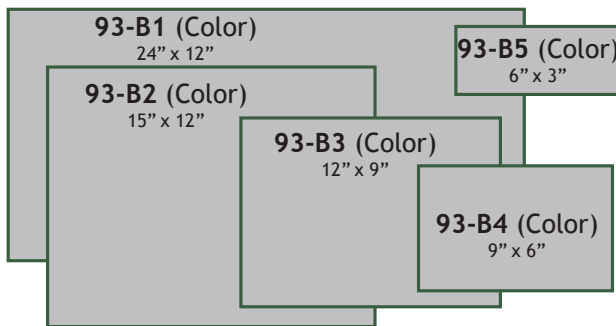

Size: W x H (mm)	Black Velvet	White Faux Leather
24" x 12" (610 x 305)	93-B1 (BK)	93-B1L (W)
15" x 12" (381 x 305)	93-B2 (BK)	93-B2L (W)
12" x 9" (305 x 229)	93-B3 (BK)	93-B3L (W)
9" x 6" (229 x 152)	93-B4 (BK)	93-B4L (W)
6" x 3" (152 x 76)	93-B5 (BK)	93-B5L (W)

Foam Tray Liner Sheet

Sheet Size: 14 1/8" x 7 5/8" (360 x 195mm)



Pad Cover

Cover Size: 14 1/8" x 7 5/8" (360 x 195mm)



Standard Display Pads



A. Full Size Pad
14 1/8" x 7 5/8"
(360 x 195mm)

B. Half Size Pad
7 3/4" x 6 3/4"
(197 x 170mm)



R -SG



Q -BE



N -N3



N -LE



	Size: L x H (mm)	Steel Grey Faux Leather	Beige Faux Suede	Burlap	Beige Linen
A.	14 1/8" x 7 5/8" (360 x 195)	DP-9301R -SG	DP-9301Q -BE	DP-9301N -N3	DP-9301N -LE
B.	7 3/4" x 6 3/4" (197 x 170)	DP-9304R -SG	DP-9304Q -BE	DP-9304N -N3	DP-9304N -LE

Loop Fabric Pad



White -WH

Black -BK



MP931 -Color

14 1/8" x 7 5/8"
(360 x 195mm)

Loop Fabric Pad
- Attach display pieces with the Velcro's Hooks side dots and strips.

Deluxe Velvet Pads



93-1V (Color)

Full Size Pad
14 1/8" x 7 5/8"
(360 x 195mm)

Available Deluxe Velvet Colors



Jewelry Display Pads



Fits in standard size tray;
Tray sold separately.

A. Full Size Pad
14 1/8" x 7 5/8"
(360 x 195mm)

B. Half Size Pad
7 3/4" x 6 3/4"
(197 x 170mm)

C. Small Size Pad
7 1/2" x 4"
(190 x 102mm)

D. X-Small Size Pad
5 1/2" x 3 1/8"
(140 x 80mm)

Available Velvet Colors:



Faux Leather Colors



	Size: L x H (mm)	Black Velvet	Blue Velvet	Grey Velvet	Red Velvet	White Velvet	Black Faux Leather	White Faux Leather
A.	14 1/8" x 7 5/8" (360 x 195)	93-1 (BK)	93-1 (BL)	93-1 (G)	93-1 (R)	93-1 (W)	93-1L (BK)	93-1L (W)
B.	7 3/4" x 6 3/4" (197 x 170)	93-4 (BK)	93-4 (BL)	93-4 (G)	93-4 (R)	93-4 (W)	93-4L (BK)	93-4L (W)
C.	7 1/2" x 4" (190 x 102)	93-6 (BK)	93-6 (BL)	93-6 (G)	93-6 (R)	93-6 (W)	93-6L (BK)	93-6L (W)
D.	5 1/2" x 3 1/8" (140 x 80)	93-5 (BK)	93-5 (BL)	93-5 (G)	93-5 (R)	93-5 (W)	93-5L (BK)	93-5L (W)

Burlap Tray Insert Pad

Tray Pad Size: 14 1/8" x 7 5/8" (360 x 195mm)

NEW



92-E3N-N3
45 Pairs Earring

NEW



BX640N-N3
12 Sections

NEW



95N-N3
51 Rings



Fits in standard size tray;
Tray sold separately.

Bracelet/Watch Tray Pad

12 Sections



BX646L (W) White Faux Leather
BX645 (BK) Black Velvet
14 1/8" x 7 5/8" (360 x 195mm)

With Easel

12 Sections



BX642L (W) White Faux Leather
BX640 (BK) Black Velvet
14 1/8" x 7 5/8" (360 x 195mm)



Fits in standard size tray;
Tray sold separately.

Tray Insert Collection

Ring Clip Pads



Ring Clips

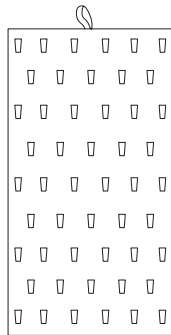

Vertical:
50 Rings

95-6L (W) White Faux Leather
95-6 (BK) Black Velvet
7 5/8" x 14 1/8"
(195 x 360mm)

Horizontal: 30 Rings

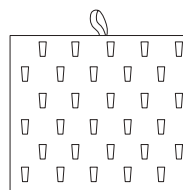

95-4L (W) White Faux Leather
95-4 (BK) Black Velvet
7 3/4" x 6 3/4" (197 x 170mm)

Horizontal: 51 Rings

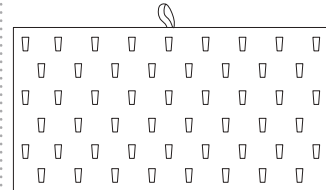

95L (W) White Faux Leather
95 (BK) Black Velvet
14 1/8" x 7 5/8" (360 x 195mm)

Earring Pads

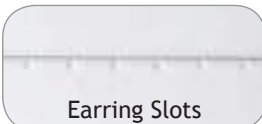

Earring Slots

6 Pairs

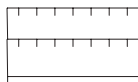

92-E5L (W) White Faux Leather
92-E5 (BK) Black Velvet
5 1/2" x 3 1/8" (140 x 80mm)

12 Pairs

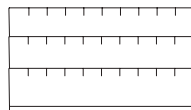

92-E6L (W) White Faux Leather
92-E6 (BK) Black Velvet
7 5/8" x 4 1/4" (194 x 104mm)

16 Pairs

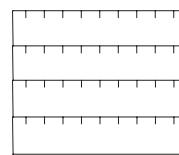

92-E4L (W) White Faux Leather
92-E4 (BK) Black Velvet
7 3/4" x 6 3/4" (197 x 170mm)

45 Pairs

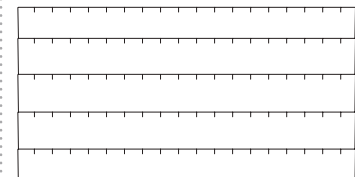

92-E3L (W) White Faux Leather
92-E3 (BK) Black Velvet
14 1/8" x 7 5/8" (360 x 195mm)

Wooden Display Stands

10 1/2" x 4 1/4" x 11" H (267 x 108 x 283mm)



DWS1 -O
Oak Finish Stand



DWS1 -DW
Dark Walnut Finish Stand

* Slide a full size pad into this wood frame to create an instant stand-up display



Pad sold separately.

216

Body Jewelry Pad

Pad Size: 14 1/8" x 7 5/8" H (360 x 195mm)

54 Hooks

68-E (BK)
Black Velvet

68-EL (W)
White Faux Leather



With Easel
Back

Pad Size: 14 1/8" x 7 5/8" H (360 x 195mm)

54 Hooks

68-D (BK)
Black Velvet



68-DL (W)
White Faux Leather

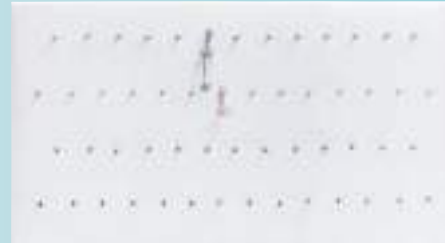

Body Jewelry Displays Tray

15 Pads w/Hooks



BJ1215V -BK
Black Leatherette w/ Black Velvet
12 1/2" x 8 3/4" x 1 7/8" H
(316 x 222 x 46mm)



BJ1215L -WH
White Faux Leather
12 1/2" x 8 3/4" x 1 7/8" H
(316 x 222 x 46mm)

24 Pads w/Hooks



BJ1024L -WH
White Faux Leather
10 1/4" x 7 1/2" x 1" H
(260 x 191 x 25mm)

Body Jewelry Stands



BJ238-2 (BK)
Black Velvet
1 3/4" x 2 3/4" H
(45 x 70mm)



BJ238-2L (W)
White Faux Leather
1 3/4" x 2 3/4" H
(45 x 70mm)



Two ways to
display

6 Hooks

BJ215-3L (W)
White Faux Leather
9 1/2" x 2" x 4"
(240 x 51 x 100)



14 Hooks

10 Hooks

BJ215-2L (W)
White Faux Leather
7" x 1 1/2" x 3 1/2"
(178 x 38 x 89)

6 Hooks



BJ214-6L (W)
White Faux Leather
6" x 2 5/8" H
(152 x 67mm)



BJ214-6 (BK)
Black Velvet
6" x 2 5/8" H
(152 x 67mm)

BJ214-7 (BK)
Black Velvet
12" x 2 5/8" H
(302 x 67mm)



12 Hooks

BJ214-7L (W)
White Faux Leather
12" x 2 5/8" H
(302 x 67mm)

Rotating Stands w/Body Jewelry Pads

4-Sided

* Comes with 4 hooked pads.
* 4-Side (total of 208 hooks).

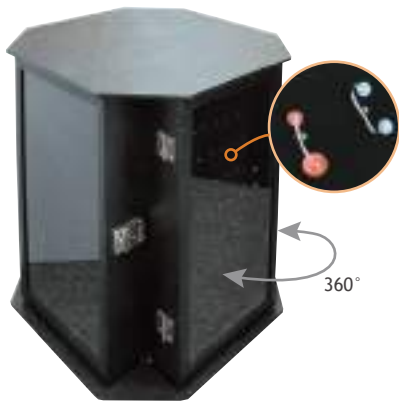

TB1004 -BK

14 5/8" x 14 5/8" x 16 1/4" H
(37 x 37 x 41cm)

3-Sided

* Comes with 3 hooked pads.
* 3-Side (total of 156 hooks).



TB1003 -BK

14" x 14" x 16 1/4" H
(36 x 36 x 41cm)

3-Sided Large

* Comes with 3 large hooked pads.
* 3-Side (total of 324 hooks).



TB1006 -BK

15 1/4" x 15 1/4" x 19 1/4" H
(39 x 39 x 49cm)

Body Jewelry Pad for TB1003, TB1004

52 Hooks

7 5/8" x 14 1/8" H
(195 x 360mm)

With Easel Back

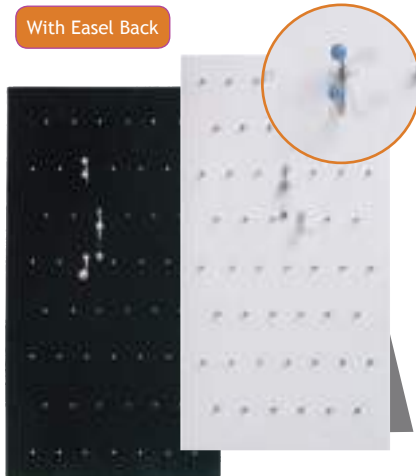

68-EH (BK)
Black Velvet

68-EHL (W)
White Faux Leather

52 Hooks

7 5/8" x 14 1/8" H
(195 x 360mm)



68-DH (BK)
Black Velvet

68-DHL (W)
White Faux Leather

Body Jewelry Pad for TB1006

108 Hooks

11 5/8" x 16 1/4" H
(295 x 413mm)



68-FH (BK)
Black Velvet

68-FHL (W)
White Faux Leather

Body Jewelry Display
Collection

218

High Density Toe-Ring Foams



RD4312G -Color
12 Rings

5 1/4" x 2 1/4"
(135 x 58mm)



RD4320G -Color
20 Rings

7 1/2" x 3 1/4"
(187 x 85mm)



RD4324G -Color
24 Rings

9" x 3 7/8"
(230 x 100mm)

Available Colors



Black
-BK



Green
-GN



Blue
-BL



Yellow
-YL

Toe-Ring Foams



RD4308F -Color

8-slot

3 1/4" x 3 1/4" (82 x 82mm)

Available Colors



Black
-BK



Grey
-G



Red
-RD

Toe-Ring Displays

2 3/4" x 1 1/2" x 1 1/4" H (72 x 38 x 30mm)



RD4301R -BW



RD4301R -NW



RD4301R -LW



RD4301R -RW



RD4301R -BK

■ Glass-Top Watch Display Cases



* 10 removable foam inserts.

■ Glass-Top Case with 18-Collars



217-2C
14 3/4" x 8 1/4" x 2 5/8" H
(37.5 x 21 x 6.7cm)

■ Solid-Top Case with 18-Collars



217-2B
14 3/4" x 8 1/4" x 2 5/8" H
(37.5 x 21 x 6.7cm)

■ Removable Lid Case with 18-Collars



217-2A
14 3/4" x 8 1/4" x 2 1/4" H
(37.5 x 21 x 6cm)

Watch Display Collection

219

■ Standard Watch Tray with 18 Watch Collars

Tray Size: 14 3/4" x 8 1/4" x 1 1/8" H (37.5 x 21 x 3cm)



217-D (BK)
Black Leatherette Wooden Tray

217-P (W)
White Stackable Plastic Tray

217-P
Black Stackable Plastic Tray

Black Faux Leather Watch Cases w/Grey Insert



Glass Top



Black faux leather with grey pillows.

CBW220

10 Watches

11 5/8" x 8" x 3 1/4" H
(29.5 x 20 x 8.5cm)



Solid Top



Black faux leather with grey pillows.

CBW222

10 Watches

11 5/8" x 8" x 3 1/4" H
(29.5 x 20 x 8.5cm)

Watch Display Collection

220



Glass Top



Black faux leather with grey pillows.

CBW230

20 Watches

11 5/8" x 8" x 6" H
(29.5 x 20 x 15cm)



Glass Top



Black faux leather with grey pillows.

CBW120

5 Watches

11 5/8" x 4" x 3 1/4" H
(29.5 x 10 x 8.5cm)

Black Faux Leather Watch Cases for Large Watch



High clearance for large watches

Glass Top



Black faux leather with grey velvet pillows.

WC-2336L -BK

36 Watches

14 1/4" x 12" x 7 1/8" H
(36.2 x 30.5 x 18.1cm)



High clearance for large watches

Glass Top



Black faux leather with black velvet pillows.

WC-2218L -BK

18 Watches

14 1/4" x 12" x 3 3/4" H
(36.2 x 30.5 x 9.5cm)

■ Premium Faux Leather Watch Cases



Solid Top



Simulated carbon fiber pattern case with black faux leather interior



Carbon Fiber Texture

CBW222 -PT

10 Watches

11 5/8" x 8" x 3 3/4" H
(29.5 x 20 x 9.5cm)



Solid Top



Simulated carbon fiber pattern case with suede lining and faux leather pillows



Carbon Fiber Texture

CBW170 -PT

6 Watches

7" x 6 5/8" x 3 1/8" H
(18 x 17 x 8cm)



Glass Top



Simulated carbon fiber pattern case with black velvet interior



Carbon Fiber Texture

WC-2336L -PT

36 Watches

14 1/4" x 12" x 7 1/8" H
(36.2 x 30.5 x 18.1cm)



Solid Top



Textured faux leather with black velvet lining, and black faux leather pillows.

CBW170

6 Watches

7" x 6 5/8" x 3 1/8" H
(18 x 17 x 8cm)

Watch Display Collection

221

■ Faux Leather Cases w/ 20-Watch Pillow



Soft brown faux leather watch case with beige faux suede interior.

CBW230 -74L

20 Watches

11 5/8" x 8" x 7 1/4" H
(29.5 x 20 x 18cm)



Simulated carbon fiber pattern case with black velvet interior.

CBW230 -PT

20 Watches

11 5/8" x 8" x 7 1/4" H
(29.5 x 20 x 18cm)

High Gloss Black Wood w/ Black Velvet Watch Cases



Glass Top



CBW250 -BK

10 Watches

12" x 8 1/8" x 4" H
(30.5 x 20.5 x 10.2cm)



Glass Top



CBW255 -BK

17 Watches

12 1/4" x 8 1/8" x 7 5/8" H
(31 x 20.5 x 19.5cm)

Rosewood with Beige Faux Leather Watch Cases

Watch Display Collection

222



Solid Top



CBW123 -RW

5 Watches

11 7/8" x 4 1/8" x 3 1/4" H
(30 x 10.5 x 85cm)



Glass Top



CBW120 -RW

5 Watches

11 7/8" x 4 1/8" x 3 1/4" H
(30 x 10.5 x 85cm)



Solid Top



CBW223 -RW

10 Watches

11 5/8" x 8" x 3 1/4" H
(29.5 x 20 x 8.5cm)



Glass Top



CBW220 -RW

10 Watches

11 5/8" x 8" x 3 1/4" H
(29.5 x 20 x 8.5cm)



Solid Top



CBW233 -RW

20 Watches

11 5/8" x 8" x 6 1/2" H
(29.5 x 20 x 16.5cm)



Glass Top



CBW230 -RW

20 Watches

11 5/8" x 8" x 6 1/2" H
(29.5 x 20 x 16.5cm)

High Gloss Wooden Watch Case



High gloss carbon fiber pattern case with black velvet interior.



NEW



CBW250-CF
12" x 8 1/8" x 4"H
(30.5 x 20.5 x 10.8 cm)

Faux Leather Angle Tray w/20 Pillows

Tray Size: 10" x 16" x 3" H (255 x 405 x 75mm)

Angle tray enhances viewing merchandise



WT-1320L -BK
Black Faux Leather Tray
w/ Black Faux Leather Pillows



WT-1320L -WH
White Faux Leather Tray
w/ White Faux Leather Pillows



WT-1320L -78R
Steel Grey Faux Leather Tray
w/ Black Faux Leather Pillows

Watch Display Collection

223

Light Weight Watch Case w/Handle

* Black textured faux leather case with grey faux suede interior. 18 watch pillows and 8 more watch compartments on the top lid.

This case is perfect for displaying watches and ready to take on the go.



Non-Slip, clip-on strap



Open the top to reveal, more watch compartments



WC-2031 -BK
Holds 26 Watches
13 3/4" x 11 1/8" x 3 3/4" H
(35 x 28 x 10cm)

Black Attachè Watch Case

* Sleek and sturdy, features a 3-digit combination lock.
* Black faux leather case with black velvet lining



WC-2024L-BK
24 Watches
14 7/8" x 14 7/8" x 3 1/2" H
(38 x 38 x 9cm)

Watch Display Stands

2 3/4" x 2 3/4" x 2 3/8" H (70 x 70 x 60mm)



WD-0551 -N3
Burlap
w/ Natural Wood Trim



WD-0551 -74L
Beige Suede w/
Brown Faux Leather



WD-0551 -BK, G
Grey Suede w/
Black Faux Leather

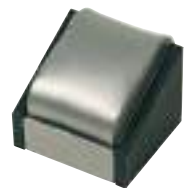

WD-0551 -87R
Steel Grey w/
Black Faux Leather



WD-0551 -RW
White Faux Leather w/
Rosewood Trim



WD-0551 -DW, LE
Linen w/
Dark Walnut Trim

2" Dia. x 3 1/2" H (50 Dia. x 89mm)

2" Dia. x 4 1/4" H (50 Dia. x 108mm)



WD-0105Q -BE
Beige Faux Suede



WD-0106Q -BE
Beige Faux Suede



WD-0106R -SG
Steel Grey Faux Leather



240-6
Black Velvet



240-6L (W)
White Faux Leather



240-5L (W)
White Faux Leather



240-5
Black Velvet

5 3/8" x 3" x 3 3/8" H (137 x 78 x 85mm)

3 1/4" x 3 1/4" x 3 3/8" H (82 x 82 x 85mm)



DBW110 -BK
Black Velvet

DBW110 -WH
White Faux Leather



WD-0101R -SG
Steel Grey Faux Leather



101L (BK)
Black Faux Leather



101L (W)
White Faux Leather



WD-0101Q -BE
Beige Faux Suede



101 (BK)
Black Velvet

2 1/4" x 2 1/4" x 3 1/2" H (55 x 55 x 89mm)

3" x 2 1/2" x 2" H (76 x 63 x 51mm)



F9-5 (RW)
White Faux Leather
w/Rosewood Trim



F9-5 (W)
White Faux Leather



F35-3 (87R)
Steel Grey Faux Leather
w/Black Trim



F35-3 (O,BK)
Black Faux Leather
w/Oak Trim



F35-3 (RW)
White Faux Leather
w/Rosewood Trim

Deluxe Watch Box

5 3/4" x 4 1/8" x 2 3/8" H (145 x 105 x 60mm)



Each deluxe watch box includes two-piece packer.



Watch Pillow Style

WB101L -GN
Green with Beige Interior



NEW

NEW

WB102L -GN
Green with Beige Interior

Watch Collar Style

WB102L -DG
Green with Dark Green Interior

Watch Showcase Display Set

White Faux Leather with Oak Finish Trim

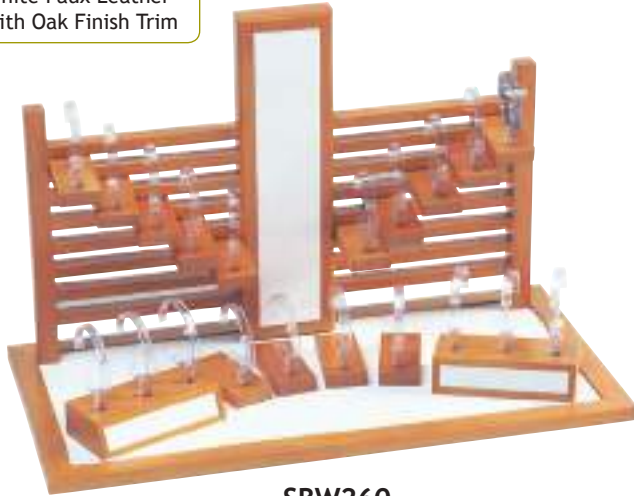

SBW260

20-Watch Set

25 3/4" x 13" x 16 1/2" H
(65 x 33 x 42cm)

Chestnut Suede with Vintage Finish Trim



SBW260 (54)

20-Watch Set

25 3/4" x 13" x 16 1/2" H
(65 x 33 x 42cm)

Watch Stand Set



DBW260

Pyramid Oak Base

1 1/2" sq. x 5", 5 3/4", 6 3/4" H
(38sq. x 127, 146, 170mm)

3 Pcs Set

Frosted Acrylic Display Set



Adjustable watch collar.

1497

Set of 3

3/8" x 1 3/8" x 5", 5 3/4", 6 1/4" H
(35 x 35 x 125, 145, 160mm)



Adjustable watch collar.

1496

Double Watch Stand

4" x 2 3/4" x 4 3/4" H
(100 x 70 x 120mm)

Watch Display Collection

225

Acrylic Watch Display Cases

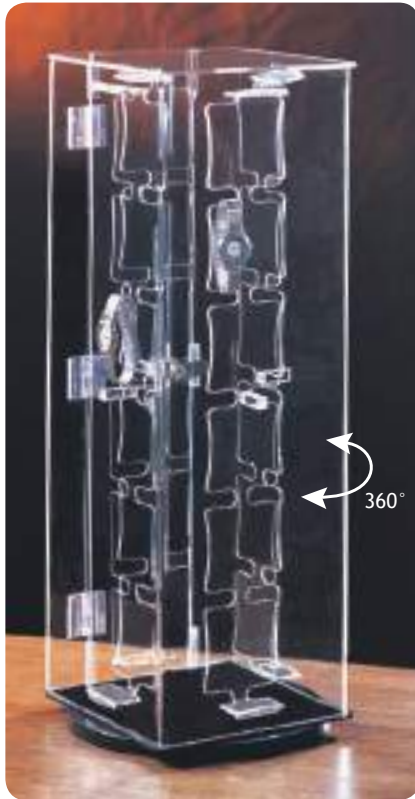

CBW140
For 48 Watches
7" x 7" x 22" H
(18 x 18 x 55cm)



* The shelves can be taken out to become a single display platform.
CBW340
For 60 Watches
12" x 8 1/2" x 24 1/2" H
(30 x 21 x 62cm)



* Shelf can serve as single display platform.
CBW240
For 36 Watches
12" x 8 1/2" x 15 1/4" H
(30 x 21 x 38cm)

Acrylic Watch Display



DBW440
For 17 Watches
13 3/4" x 12 3/4" x 7" H
(35 x 32 x 18cm)

Acrylic Watch Display Stand

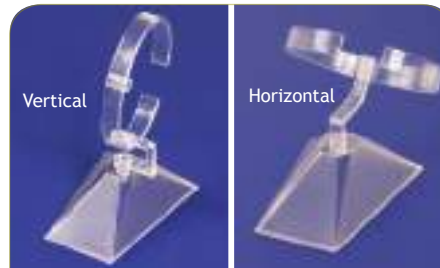

* WD-1501-CL allows you to display almost any watch in 2 different ways. Made from long lasting plastic.

WD-1501-CL
2 1/4" x 3" x 3" or 4 1/2" H
(57 x 76 x 76 or 114mm)



WD-1512-CL
For 12 Watches
11 3/4" x 8 x 3 3/4" H
(30 x 20.5 x 9.5cm)



BX7330-3
Set of 4
1" x 1" x 3 3/4", 4 1/8", 4 1/2", 5" H
(25 x 25 x 95, 105, 114, 127mm)



1494
Single Watch Stand
1 1/2" x 2" x 3" H
(40 x 52 x 75mm)



DBW240
Single Watch Stand
1 3/8" x 2 1/4" x 3 1/8" H
(36 x 58 x 80mm)

■ Acrylic Plier Rack

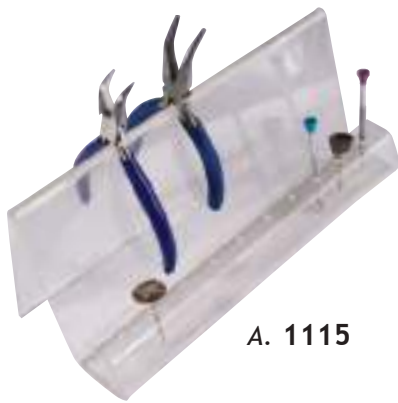

A. 1115

■ Acrylic Stand

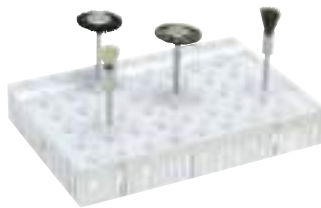

B. T1010

■ Acrylic Tool Organizer

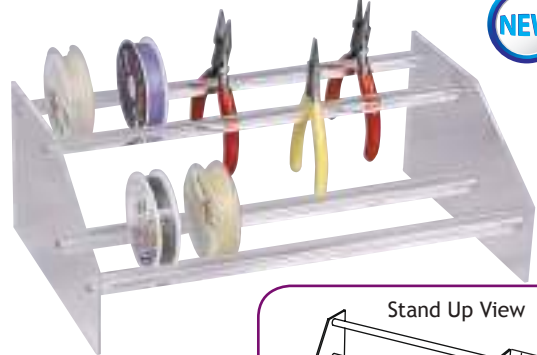

C. T18-1011

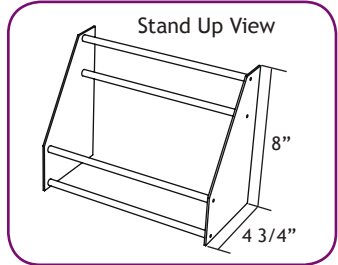

■ Beadpro™ Multifunction Stations



D. BP811 -54

* U. S. Patents Pending



E. 91-811

* Bag sold separately

Bag Fits
BP811-54

A. 1115 10 1/2" x 3 3/4" x 4" H (26.7 x 10 x 10.2cm)
* 10 holes in various sizes
* Tools not included

B. T1010 4 1/4" x 3" x 3/4" H (10.8 x 7.6 x 2cm)
* 40 - 3/32" holes
* Tools not included

C. T18-1011 13" x 8" x 4 3/4" H (33 x 20.3 x 12.1cm)
* 2 Display options
* Assembly required
* Tools not included

D. BP811-54 20" x 16" x 5 1/8" H (50.8 x 40.6 x 13cm)
* 5 drawers and 2 bars for pliers
* 6 compartments & 1 large compartment
* 3 layers to hold burs

E. 91-811 21" x 5 1/2" x 17" H (53.3 x 14 x 43.2cm)
* Carrying case for #BP811 -54

F. BP803-54 18" x 6" x 9 1/2" H (45.7 x 15.2 x 24.1cm)
* 8 drawers and 1 bar for pliers, tools
* 2 elastic straps on lid to hold small tools
* 3 layers to hold burs
* Tools not included

G. BP801-54 7" x 10 3/8" x 6" H (17.8 x 26.3 x 15.2cm)
* 1 drawer and 1 bar for pliers
* 7 compartments for wire, string rolls
* 3 elastic straps on lid to hold small tools
* Tools not included



F. BP803 -54



G. BP801 -54

Mini Tool Organizers

- * Fit perfectly on top of our mini workbenches.
- * U. S. Patent

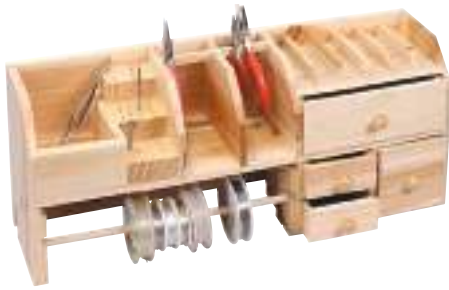

A. BP292



B. BP294



* Add benchtop organizer to double your storage area

- A. BP292** 18" x 5" x 7 3/8" H (46 x 13 x 19cm)
- * 2 bars holding pliers, tools
 - * 4 drawers (1 drawer for testing kits)
 - * 3 layers holding burs
 - * 6 compartments
 - * Fit on any 20" or wider workbench (mini workbench BP210-1, BP220-1 or regular workbench)
 - * Assembly required, tools not included

- B. BP294** 18" x 5 1/2" x 13" H (46 x 14 x 33cm)
- * 2 bars holding pliers, 1 ruler bar
 - * 2 slightly angled shelves
 - * 8 hooks for hanging beadstring spools, wires and tools
 - * Fit on any 20" or wider workbench (mini workbench BP210-1, BP220-1 or regular workbench)
 - * Assembly required, tools not included

- C. BP210-1** 20" x 16" x 10" H (51 x 41 x 25cm)
- * 4 graduated drawers (1 drawer is lockable)
 - * Aluminum-lined work tray
 - * Insert-holes for mandrels
 - * 1 armrest for support
 - * Hardwood bench pin
 - * Railing prevents items from falling off the back or sides

- D. BP220-1** 20" x 16" x 10" H (51 x 41 x 25cm)
- * 9 storage drawers, center drawer is lockable
 - * A center pull-out shelf
 - * Railing prevents items from falling off the back or sides

- E. BP281-1** 17 3/4" x 13 1/4" x 25 3/4" H (45 x 34 x 65cm)
- * hardwood legs
 - * Supports mini workbench BP210-1, BP220-1

- F. T1100-2** 2 3/4" x 6 1/4" x 1 1/2" H (7 x 16 x 4cm)
- * Fit with mini workbench, or regular workbench

- G. T30-1702** 3 1/2" x 3" x 15" H (9 x 7.6 x 38.1cm)
- * New low-heat LED design, silent, no cooling fan needed.
 - * 5,500K, offers pure white light.
 - * 6W, 100-120V no Adapter needed.
 - * 30,000 hours of quality lighting.
 - * The half clear and half opaque LED tube housing allows easy adjustment of brightness
 - * Flex gooseneck lamp with 3 tubes of LED.

LED Gem Grading Light



G. T30-1702



Mini Workbenches

- * These mini-scale versions of the jeweler's workbench are compact and portable to fit in small spaces.

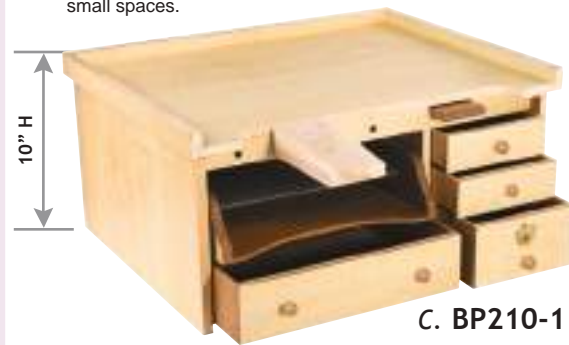

C. BP210-1



D. BP220-1

Folding Legs



E. BP281-1



Customize your own space-saving work area by mixing and matching the organizer with the workbench and supporting bench stand.

Bench Pin

F. T1100-2



Standard Jeweler's Workbenches



B. BP101

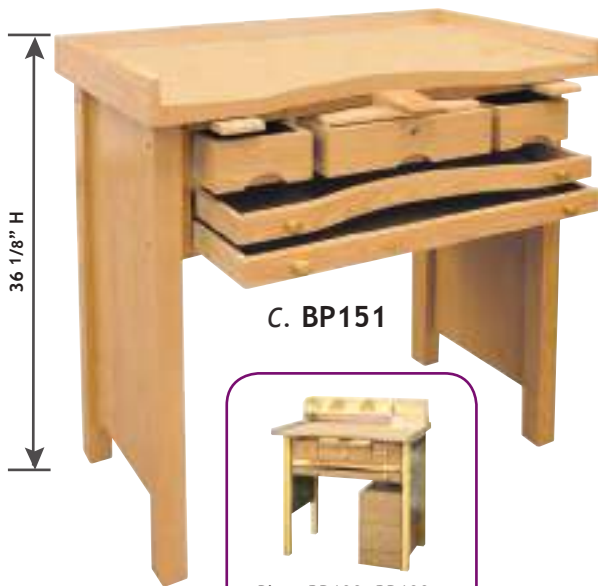

C. BP151



Place BP192, BP193, BP194 on workbench and BP181 under the bench for more space.

Benchtop Storage Shelf

* US Patent



D. BP192

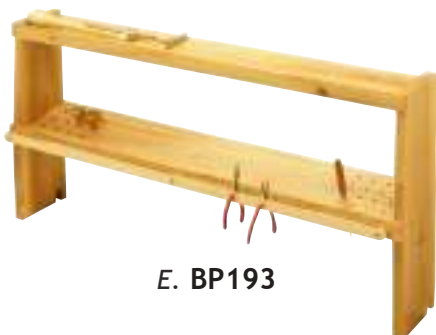

E. BP193

F. BP194

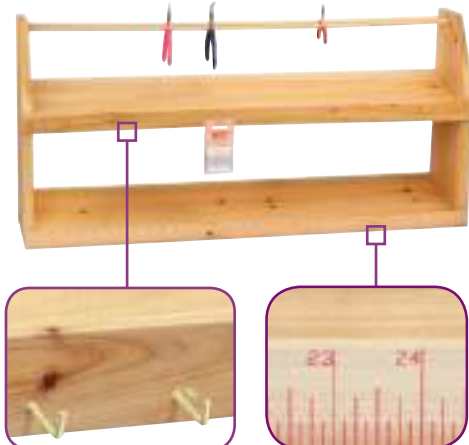

Mini Thread & Tool Organizer

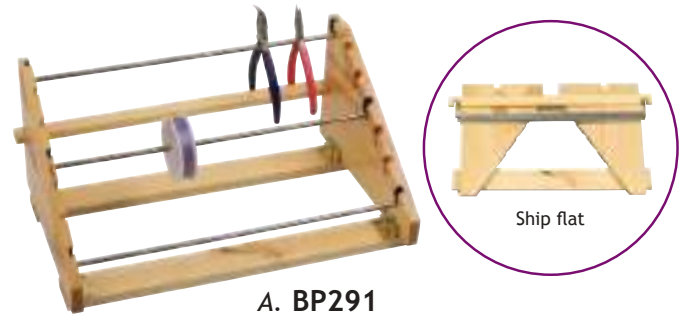

A. BP291

- A. BP291** 14" x 9" x 6 1/2" H (35.6 x 22.8 x 16.5cm)
 * 3 steel rods
 * Assembly required, tools not included
- B. BP101** 37 1/4" x 18 1/2" x 39 1/8" H (94.5 x 47 x 99.5cm)
 * 3 graduated drawers
 * Aluminum-lined work pan
 * Railing prevents items from falling off the back or sides
 * 2 armrests for support
 * Hardwood bench pin
 * Insert-holes for mandrels
- C. BP151** 35 1/4" x 21 1/4" x 36 1/8" H (89.5 x 54 x 91.9cm)
 * 3 storage drawers, center drawer locks
 * Railing prevents items from falling off the back or sides
 * A center pull-out shelf and 2 pull-out armrests
 * Hardwood bench pin
 * 2 aluminum-lined catch trays
- D. BP192** 33 3/4" x 6 1/2" x 8 1/4" H (86 x 16.5 x 21cm)
 * 2 bars to hold pliers and tools
 * 4 drawers (1 drawer for testing kits)
 * 3 layers to hold burs
 * 6 compartments
 * Fits on any 35" or wider workbench (BP101, BP151)
 * Tools not included
- E. BP193** 33 3/4" x 7 1/8" x 17 1/4" H (86 x 18 x 44cm)
 * 1 front bar to hold pliers and tools
 * 2 shelves, lower shelf slightly angled with 16 holes in size 1/4", 12 holes in size 1/2" for files
 * Assembly required
 * Fits on any 35" or wider workbench (BP101, BP151)
 * Tools not included
- F. BP194** 33 3/4" x 7 1/4" x 16" H (86 x 18.5 x 41cm)
 * 2 bars to hold pliers and tools, 1 ruler bar
 * 2 slightly angled shelves
 * 16 hooks for hanging beadstring spools, wires and tools
 * Assembly required
 * Fits on any 35" or wider workbench (BP101, BP151)
 * Tools not included
- G. BP181** 10 1/2" x 16" x 21 1/2" H (27 x 41 x 54.5cm)
 * 5 drawers, top drawer is lockable
 * 4 wheels on bottom (assembly required)
 * Fits under workbench BP101, BP151
- H. BP182** 10 1/4" x 15 1/4" x 32" H (26 x 39 x 81.5cm)
 * Maximize storage space
 * Each drawer is 2 1/4" deep
 * Weight 44 lbs
 * No assembly required

Bench Drawer



G. BP181

H. BP182

Kit Includes:

B3 T54-001B



1-Reversible Block Font Dial



1-Plastic Cover

B4 T54-001C



1-Reversible Script Font Dial

B1 T54-002



1-Diamond Stylus

B2 T54-003



5-Practice Rings



1-Self-Center Jaw (Set of 3)



B5 T54-001A

First Choice™ Inside-Ring Engraver Kit



B. EGM002

Flexible Shaft System

A. MT8011-BL



A. MT8011-BL

Included:

- * Reversible switch allows the motor to operate in forward or reverse rotation.
- * 1/8 HP motor achieves speed up to 18,000 rpm.
- * Easy maintenance ball-bearing engine.
- * Flexible shaft accepts brand name hand piece.
- * No. 30 hand piece and 39" flexible cable included.
- * Comes with slip-resistant electronic foot control that allows control from low to full speed.

First Choice™ Engraving Machine Kit

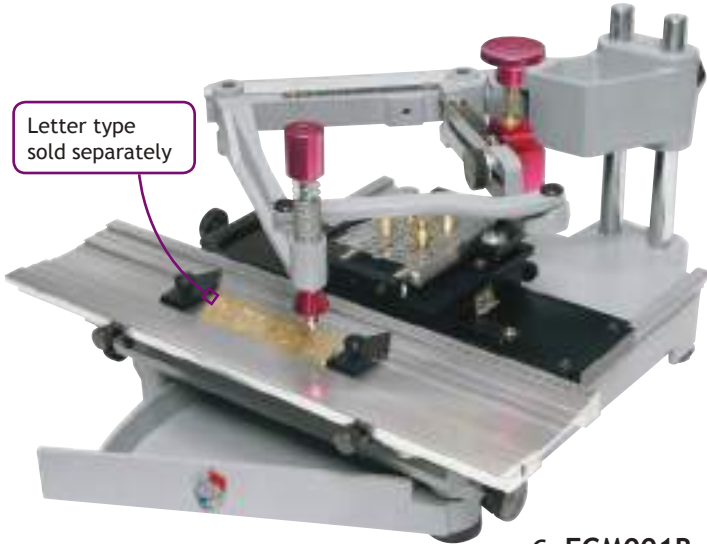

C. EGM001B

Letter type sold separately

C1 T54-050/14



C2 T54-050/16

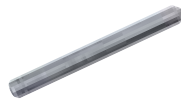

C3 54-052



HILL
6 : 1 ratio

B. EGM002 14 1/4" x 14 1/2" x 11" H (36 x 37 x 28cm)

- * Engraving machine with instruction manual, diamond stylus, practice rings, plastic cover, self-centering jaws, and 2 FREE sets of two-sided engraving dials
- * Professionally engraves gold, silver, and other material
- * Automatic letter centering
- * Accommodates narrow, wide, and stone-set rings
- * Diamond stylus tip produces a clean engraving

B1 T54-002

* Diamond Stylus

B3 T54-001B

* Reversible Block Font Dial

B2 T54-003

* Self-Center Jaw
* Comes in a set of 3

B4 T54-001C

* Reversible Script Font Dial

B5 T54-001A

* Reversible Block Font Dial

C. EGM001B 14 1/4" x 15 1/2" x 9 1/2" H (36 x 39 x 24cm)

- * Engraving machine with instruction manual, diamond head cutter, practice plates, brass pins.
- * Professionally engraves gold, silver, and other material that is flat or semi-curved.
- * The pantograph ratio from 2 3/4 : 1 to 6 : 1
- * Accepts both 1 1/4" (32mm) and 2 3/4" (70mm) blanks.
- * Female Vise rotates 360° and accepts objects up to 4" (100mm) in diameter.

C1 T54-050/14

- * Replacement Brass Pins (6 pcs)
- * To hold objects in the female vise

C2 T54-050/16

- * Replacement Diamond Stylus
- * Provides clean engraving results

C3 54-052 - Double Line Block Types - 5/8" Letters

- * 99 Capitals, 20 numerals, 10 special characters, spacers.

Tungsten Carbide Drawplates

8" x 1 3/4" H (20.2 x 4.5cm)

TDP-9



- * 36-Hole Drawplate
- * Made of polished steel and tungsten carbide
- * Shape of holes: ● (round)
- * Number of holes: 36
- * Smallest hole: 0.26mm
- * Largest hole: 2.20mm

Double Shaft Polisher and Dust Collector

23 7/8" x 17 1/4" x 12" H (61 x 44 x 31cm)

T37-5050



Included:

- * Motor : 1/2 HP pre-lubricated sealed ball bearings motor, 100 - 120 Volt, 6.4 - 7.7 AMP, 3450 RPM, 2 poles, 1/2" straight shaft with tapered spindles at both ends.
- * Lighting : Dual ceramic light sockets (light bulb not included)
- * Filtration : Single 10" fan blower
- * Filter size : 12" x 24" x 1", replaceable standard filters (included)
- * Max. wheel diameter : 6"
- * Shipping weight : 55 lbs.
- * Steel enclosure with powerful dust suction motor

Loose Buffs

- * Loose buffs have a softer action than the stitched type and are used with rouge in the coloring of final polishing.
- * Yellow buffs are chemically treated for enhanced compound-retaining properties.

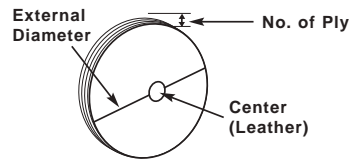

External Dia.	No. of Ply	Rows Stitching	(White) Item	(Yellow) Item
2"	16	1	T17-1321	T17-2321
3"	30	1	T17-1333	T17-2333
4"	40	1	T17-1344	T17-2344
5"	45	1	T17-1354	T17-2354
	50	1	T17-1355	T17-2355
	60	1	T17-1356	T17-2356
6"	50	1	T17-1365	T17-2365
	60	1	T17-1366	T17-2366
	80	1	T17-1368	T17-2368

Stitched Buffs

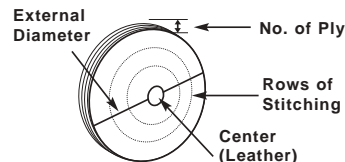

External Dia.	No. of Ply	Rows Stitching	(White) Item	(Yellow) Item
2"	16	2	T17-1221	T17-2221
3"	30	3	T17-1233	T17-2233
4"	40	3	T17-1244	T17-2244
5"	45	3	T17-1254	T17-2254
	50	3	T17-1255	T17-2255
	60	3	T17-1256	T17-2256
6"	50	4	T17-1265	T17-2265
	60	4	T17-1266	T17-2266
	80	4	T17-1268	T17-2268

Razor-edge Buffs

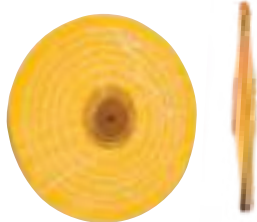

External Dia.	No. of Ply	Rows Stitching	(White) Item	(Yellow) Item
4"	12	6	T17-1294	T17-2294
5"	12	8	T17-1295	T17-2295
6"	12	10	T17-1296	T17-2296
6"	20	9	T17-1296-1	T17-2296-1

Inside Ring Felt Buffs



Length x Diameter	White Item
3" x 5/16" ~ 9/16"	T17-3212
3" x 9/16" ~ 3/4"	T17-3213
4" x 5/8" ~ 7/8"	T17-3214
5" x 11/16" ~ 1"	T17-3215

Natural Bristle Wheel Brushes

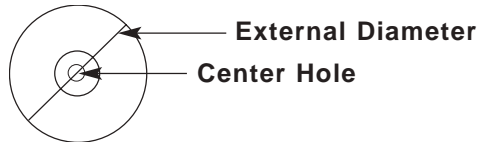

External Dia.	Bristle Color	Bristle Texture	Center Hole 3/32" Dia.	Center Hole 1/8" Dia.
3/4"	White	Extra Soft	T16-1201	T16-1231
	Grey	Soft	T16-1202	T16-1232
	Brown	Medium	T16-1203	T16-1233
	Black	Stiff	T16-1204	T16-1234
7/8"	White	Extra Soft	T16-1211	T16-1241
	Grey	Soft	T16-1212	T16-1242
	Brown	Medium	T16-1213	T16-1243
	Black	Stiff	T16-1214	T16-1244
1"	White	Extra Soft	T16-1221	T16-1251
	Grey	Soft	T16-1222	T16-1252
	Brown	Medium	T16-1223	T16-1253
	Black	Stiff	T16-1224	T16-1254
5/8"	White	Extra Soft		T16-1261
	Grey	Soft		T16-1262

Mounted on 3/32" Dia. Shank



Bristle Color	Bristle Texture	External 3/4" Dia.	External 7/8" Dia.	External 1" Dia.
White	Extra Soft	T16-1101	T16-1111	T16-1121
Grey	Soft	T16-1102	T16-1112	T16-1122
Brown	Medium	T16-1103	T16-1113	T16-1123
Black	Stiff	T16-1104	T16-1114	T16-1124

End Bristle Brushes

Mounted on 3/32" Dia. Shank

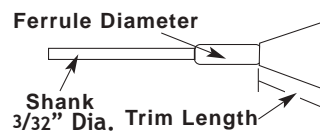

Trim Length	Bristle Color	Bristle Texture	Ferrule 3/16" Dia.	Ferrule 1/4" Dia.
1/4"	White	Soft	T16-2101	T16-2131
	Brown	Medium	T16-2102	T16-2132
	Black	Stiff	T16-2103	T16-2133
3/8"	White	Soft	T16-2111	T16-2141
	Brown	Medium	T16-2112	T16-2142
	Black	Stiff	T16-2113	T16-2143
1/2"	White	Soft	T16-2121	T16-2151
	Brown	Medium	T16-2122	T16-2152
	Black	Stiff	T16-2123	T16-2153

Brass & Steel Wheel Brushes

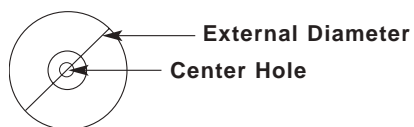

External Dia.	Material	Wire Style	Center Hole 3/32" Dia.	Center Hole 1/8" Dia.
3/4"	Brass	Crimped	T16-5201	T16-5206
	Brass	Straight	T16-5202	T16-5207
	Steel	Crimped	T16-5203	T16-5208
	Steel	Straight	T16-5204	T16-5209

Brass & Steel End Bristle Brushes

Mounted on 3/32" Dia. Shank



Material	Wire Style	1/4" Trim Length	1/2" Trim Length
Brass	Crimped	T16-4101	T16-4121
Brass	Straight	T16-4102	T16-4122
Steel	Crimped	T16-4103	T16-4123
Steel	Straight	T16-4104	T16-4124

Jewelry Test Kit Box

* Testing kit not included



A. T44-9210

Wood Bur Box

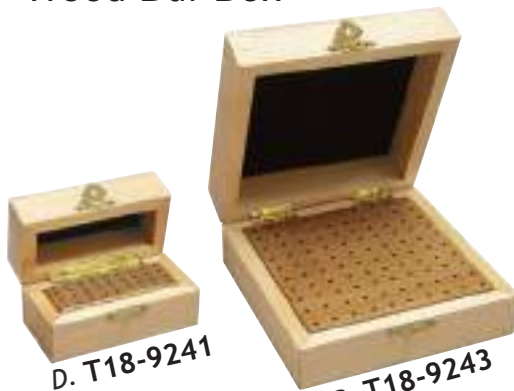

D. T18-9241

B. T18-9243



E. T18-9240

C. T18-9242

- | | |
|--------------------|---|
| A. T44-9210 | 4 1/4" x 2 3/4" x 4 1/8" H (10.8 x 7 x 10.5cm) |
| | * 5 Grids |
| B. T18-9243 | 5" x 5" x 2 1/2" H (12.7 x 12.7 x 6.3cm) |
| | * Holds 100 Burs |
| C. T18-9242 | 5 3/4" x 3 3/8" x 2 1/2" H (14.6 x 8.6 x 6.3cm) |
| | * Holds 72 Burs |
| D. T18-9241 | 4 1/2" x 2 5/8" x 2 1/2" H (11.4 x 6.7 x 6.3cm) |
| | * Holds 36 Burs |
| E. T18-9240 | 3 1/2" x 1 7/8" x 2 1/2" H (8.9 x 4.7 x 6.3cm) |
| | * Holds 12 Burs |
| F. T19-7935 | 4" Dia. (102mm) |
| | * Capacity: 175 dwt * Up to 3370°F (1850°C) |
| | * Depth: 1 3/8" (35mm) |
| G. T19-7933 | 3" Dia. (76mm) |
| | * Capacity: 100 dwt * Up to 3370°F (1850°C) |
| | * Depth: 1" (25mm) |
| H. T19-7932 | 2 1/4" Dia. (57mm) |
| | * Capacity: 40 dwt * Up to 3370°F (1850°C) |
| | * Depth: 3/4" (19mm) |
| I. T19-7931 | 1 3/4" Dia. (44mm) |
| | * Capacity: 20 dwt * Up to 3370°F (1850°C) |
| | * Depth: 5/8" (16mm) |
| J. T51-1102 | 3" Dia. (76mm) |
| | * Efficiently grinds into desired fineness |
| K. T19-4606 | |
| | * Round, capacity (6 oz) * Up to 3370°F (1850°C) |
| L. T19-4609 | |
| | * Round, capacity (9 oz) * Up to 3370°F (1850°C) |
| M. T19-4725 | |
| | * Square V-Slot, capacity (25 oz) * Up to 3370°F (1850°C) |
| N. T19-7941 | Capacity: 8 oz |
| | * Suitable for casting high-temperature alloys |
| O. T19-7942 | Capacity: 10 oz |
| | * Suitable for casting high-temperature alloys |

Melting Crucibles

H. T19-7932

F. T19-7935

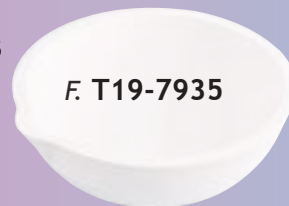

I. T19-7931



G. T19-7933

Mortar and Pestle Set



J. T51-1102

Hooded Crucibles



K. T19-4606

L. T19-4609

M. T19-4725

High Temperature Melting Dish



N. T19-7941

Straight-side Melting Crucible



O. T19-7942

High-Back Melting Crucible

LED Lighted Loupe



- * Feature 6 bright white LED lights.
- * Come with LED on/off switch
- * Battery included

LED/ UV Dual Lighted Loupe



- * Feature 6 bright white LED lights.
- * Come with LED/UV switch, battery included

Finger Size Gauge



Ring Measuring Sticks



Repair Envelope Holder

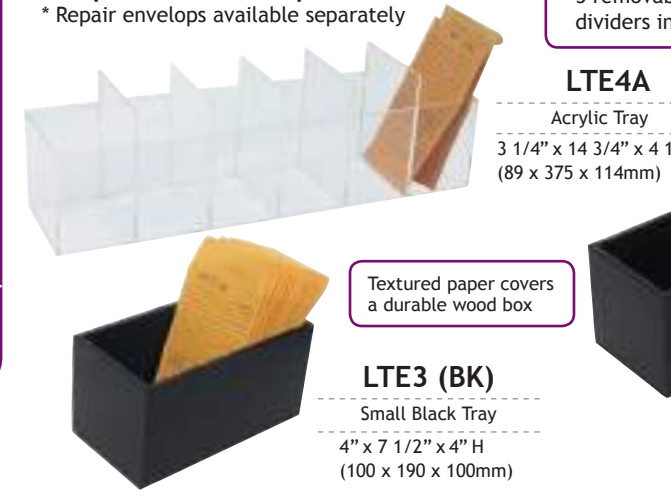

Portable Scale



3 Part Layaway Envelopes

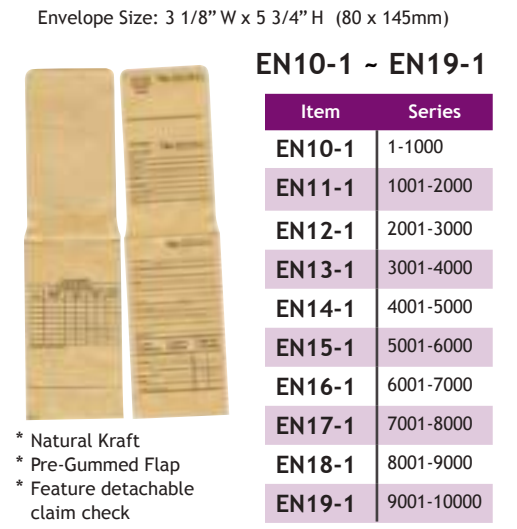

Utility Envelopes



Mini Pocket Scale



■ Precision Loupe with Leather Case



18MM Triplet



18mm Triplet, Gold/Black
 10X: **LO13**
 15X: **LO13-15**
 20X: **LO13-20**



18mm Triplet, Goldtone
 10X: **LO18**
 15X: **LO18-15**
 20X: **LO18-20**



18mm Triplet, Silver/Black
 10X: **LO19**
 15X: **LO19-15**
 20X: **LO19-20**



18mm Triplet, Silver/Black Rubber Grip
 10X: **LO19R**
 15X: **LO19R-15**
 20X: **LO19R-20**



18mm Triplet, Silvertone
 10X: **LO20**
 15X: **LO20-15**
 20X: **LO20-20**



18mm Triplet, Black
 10X: **LO22**
 15X: **LO22-15**
 20X: **LO22-20**

20.5MM Triplet



20.5mm Triplet, Silver/Black
 10X: **LO26**
 15X: **LO26-15**
 20X: **LO26-20**



20.5mm Triplet, Gold/Black
 10X: **LO27**
 15X: **LO27-15**
 20X: **LO27-20**



20.5mm Triplet, Black/Black
 10X: **LO28**
 15X: **LO28-15**
 20X: **LO28-20**

21MM Triplet



21mm Triplet, Silvertone
 10X: **LO38**
 15X: **LO38-15**
 20X: **LO38-20**



21mm Triplet, Goldtone
 10X: **LO39**
 15X: **LO39-15**
 20X: **LO39-20**

Tri-Loupe



10X, 15X, 20X
LO89
 18mm Triplet
 Silvertone

Double Loupe

18mm Triplet
 12mm 5 Elements
 Silvertone



10X, 20X:
LO42

12mm 5 Elements



20X: **LO43**
 Silvertone

18MM Doublet

No Leather Case Included.



18mm Doublet, Silver/Black
 10X: **LO30**
 15X: **LO30-15**

18MM Doublet



10X: **LO8**
 Silver/Black

21MM Doublet



10X: **LO9**
 Silver/Black

Loupe Chain



LO34
 Silvertone

LO35
 Goldtone



Chain Length:
 30" L (76cm)

Giant Magnifier Loupe



2" Dia.
 (50mm) Lens

10X: **LO900**
 Open size: 6 1/4" x 2 1/4"

Clear Plastic Hang Tabs

* Change regular earring cards into space-saving hanging cards.



Lint Remover

Features "fold and twist" function. Makes portability even more advanced. Simply wash under running water and use over and over. Fold to fit any purse or pocket.



Clear Plastic J-Hook Hang Tabs

Individual Size: 1" x 1 3/4" (25 x 44mm)



Simply use the self adhesive back to create a hanging item. Great for use with many items.



Beige and White Polish Cloth

* Available in two sizes.

* Polish many different style of jewelry with ease.



PS1215 (BE)
Open Size: 12" x 15"
(305 x 381mm)

Jewelry Polishing Cloth



PS1215 (Color)
Open: 12" x 15"
(305 x 381mm)



PS406 (Color)
Open: 4" x 6"
(102 x 152mm)

Available Colors



Grey
(G)



Blue
(BL)

Micro Fiber Polishing Cloth



PS907 (PK)
Open: 9 3/4" x 7 3/4"
(248 x 197mm)



PS506 (PK)
Open: 5" x 6"
(127 x 152mm)



PS406 (BE)
Open Size: 4" x 6"
(102 x 152mm)



Interlocking Pricing Block Set

- * The 200 piece set contains 20 \$ signs, 60 zeros, 10 of each number 1-9, 10 commas and 20 dashes.
- * Blocks are angled for viewing ease.
- * The set comes with a clear protective case to organize and avoid loss of pieces.

1/4" x 3/8" H
(4 x 7mm)



TA-2033
Gold



TA-2034
White

Metal Signs

Large Sign

3 1/2" x 2" H (89 x 50mm)



TA-60



TA-61



TA-62



TA-66



TA-68



TA-80



TA-82



TA-84



TA-89

Small Sign

1 3/4" x 1 1/4" H (44 x 32mm)



TA-601



TA-661



TA-831



TA-841



TA-801

Frosted Signs



Red Letter
(RD)

Black Letter
(BK)

3" x 1 1/4" H (76 x 32mm)



TA-603 (Color)

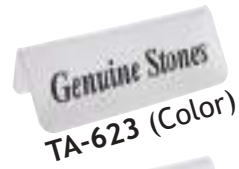

TA-623 (Color)



TA-663 (Color)



TA-693 (Color)

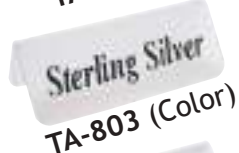

TA-803 (Color)

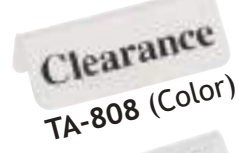

TA-808 (Color)



TA-823 (Color)

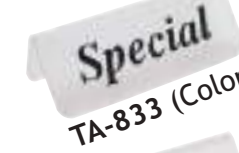

TA-833 (Color)



TA-843 (Color)

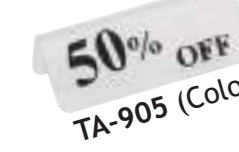

TA-905 (Color)

Crystal Signs

1 5/8" x 3/4" (40 x 19mm)



TA-595



TA-625



TA-665



TA-825



TA-845

Price Labeler Kit



TM-5501
Labeler Kit

- Kit contains:
 -Labeler, Preloaded ink roller
 * Single line
 * up to 8 characters
 * Easy-squeeze trigger



Price Labeler Replacement Parts

1000 Labels/Roll 13/16" x 15/32" (21 x 12mm)



Rat Tail Computer-Feed Tags

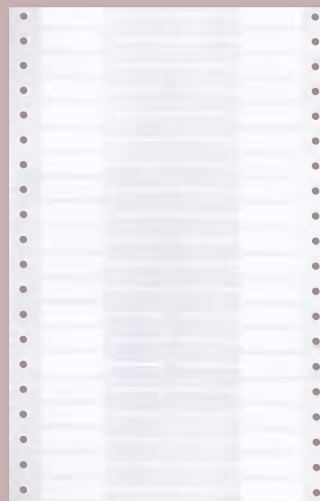

TA735
1 1/4" x 1/2"
(32 x 11mm)

- * Mounted 2 across
- * Tear-proof **Tyvek** Material
- * Withstand chemical
- * 40 tags/sheet, 5000 tags/pack

Store Supplies Collection

238

Self Adhesive Plain Labels



Ready to display package

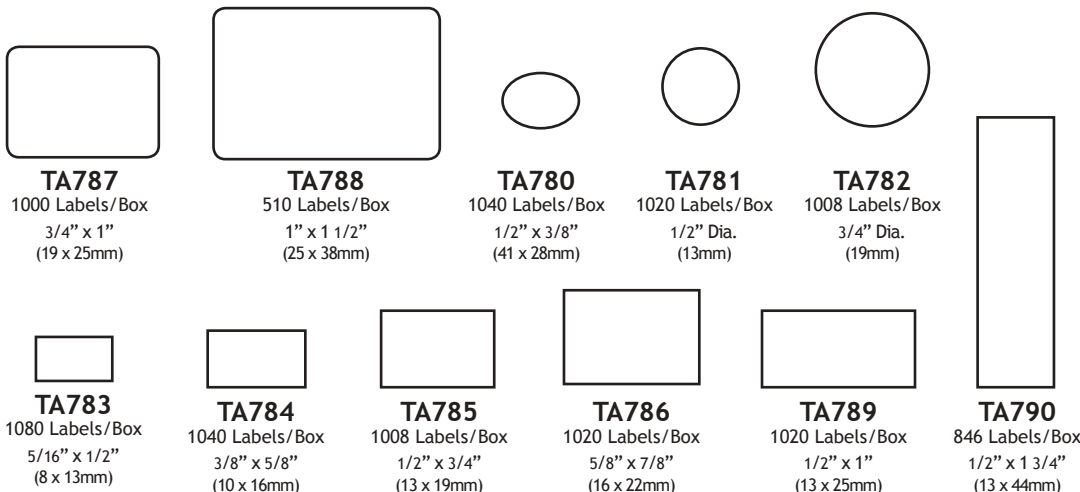

Self Adhesive Pre-Printed Labels

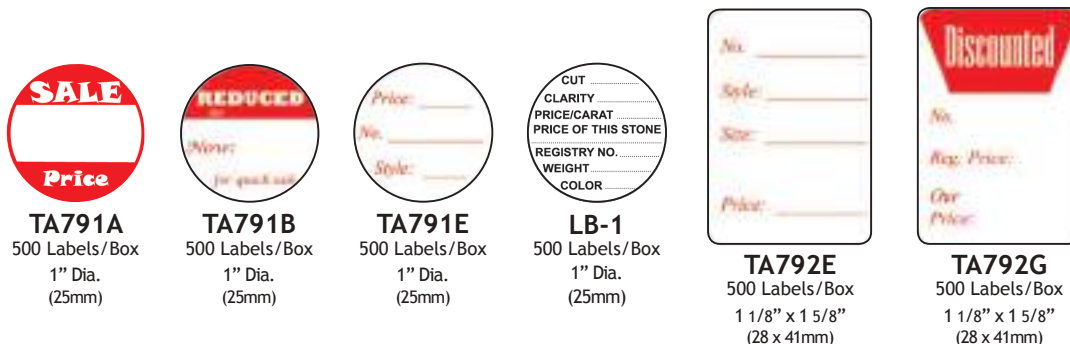

Ready to display package

Large Paper Price Signs

7" W x 5 1/2" L (178 x 140mm)

50 Tags/Pack



TA1150



TA1151



TA1152



TA1153



TA1154



TA1155



TA1156



TA1157



TA1158



TA1159



TA1161



TA1162

Small Paper Price Signs

2 3/4" W x 1 7/8" L (70 x 46mm)

50 Tags/Pack



TA1130



TA1131



TA1132



TA1133



TA1134



TA1136



TA1137



TA1138



TA1139



TA1141



TA1142



TA1144

Plastic Message Signs

11" W x 7" L (280 x 178mm)

12 Tags/Pack

* Made of heavy duty plastic with scratch resistant pebbled finish for added durability.



TA-24
* Two-Sided
* Reversible



TA-25



TA-26



TA-27



TA-28



TA-29



TA-30



TA-31



TA-32



TA-33



TA-35



TA-36



TA-37



TA-39



TA-40



TA-41



TA-42



TA-43



TA-44



TA-45



TA-46

Economy Mini Tags Assortment

Each Bag Includes ALL 32 Styles (250 Tag/Bag):

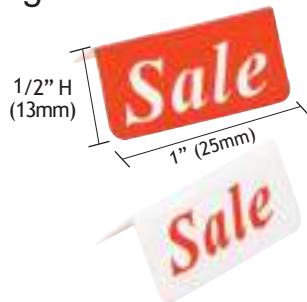

TA110

Total of 250 Tags/Bag



All Jewelry String Tags are Available in 2 Materials:



Example: TA760 = paper string tag,
TA760P = plastic string tag.

* Please specify material and color when ordering.

Paper String Tags
- 1000 Tags/Pack -

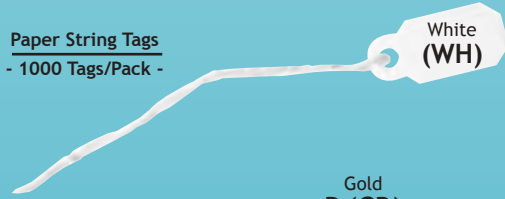

Plastic String Tags
- 1000 Tags/Pack -

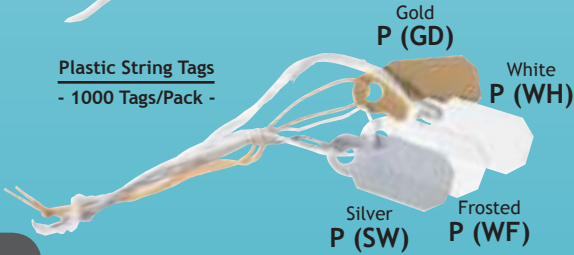

Jewelry String Tags

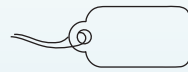

5/16" x 5/8" (8 x 16mm)

Paper **TA760 (WH)**
Plastic **TA760P (Color)**



5/16" x 3/4" (8 x 20mm)

Paper **TA761 (WH)**
Plastic **TA761P (Color)**



3/8" x 7/8" (10 x 22mm)

Paper **TA762 (WH)**
Plastic **TA762P (Color)**

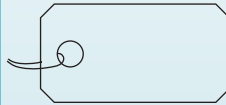

1/2" x 1" (13 x 25mm)

Paper **TA763 (WH)**
Plastic **TA763P (Color)**

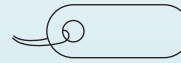

5/16" x 3/4" (7 x 19mm)

Paper **TA764 (WH)**
Plastic **TA764P (Color)**



1/4" x 3/4" (6 x 19mm)

Paper **TA765 (WH)**
Plastic **TA765P (Color)**

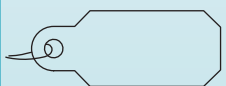

3/8" x 1" (10 x 26mm)

Paper **TA766 (WH)**
Plastic **TA766P (Color)**



1/2" x 7/8" (12 x 23mm)

Paper **TA767 (WH)**
Plastic **TA767P (Color)**



7/16" x 1 1/8" (11 x 29mm)

Paper **TA769 (WH)**
Plastic **TA769P (Color)**

Pre-Printed String Tags

* Both paper and plastic tags come with durable premium braided cotton string.

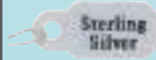

TA762PS -SS
Plastic Sterling Silver
3/8" x 7/8"
(10 x 22mm)



TA762PG -14
Plastic 14KT Gold
3/8" x 7/8"
(10 x 22mm)



TA762W -N
Paper New
3/8" x 7/8"
(10 x 22mm)

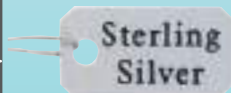

TA763PS -SS
Plastic Sterling Silver
1/2" x 1"
(13 x 25mm)



TA763PG -14
Plastic 14KT Gold
1/2" x 1"
(13 x 25mm)



TA763PW -N
Plastic New
1/2" x 1"
(13 x 25mm)



TA762PW -S
Plastic Sale Tags
3/8" x 7/8"
(10 x 22mm)



TA763W -S
Paper Sale Tags
1/2" x 1"
(13 x 25mm)



TA763W -N
Paper New
1/2" x 1"
(13 x 25mm)

Adhesive Tear-Proof Tags



1000 Tags/Pack
*Self-stick
*Tear-proof
Tyvek
material

1 3/4" x 1/2" (44 x 12mm)

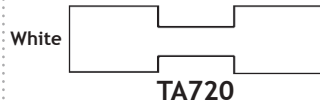

TA720



TA721



TA722

1 7/8" x 1/2" (47 x 12mm)



TA730



TA731



TA732

1 3/8" x 1/2" (35 x 12mm)



TA70



TA71



TA72

White Strung/Unstrung Tags

- * 1000 Pc/Bag, 5000 Pc/Box
- * Sold in box only
- * Item K, L, N, O, with preprinted information.

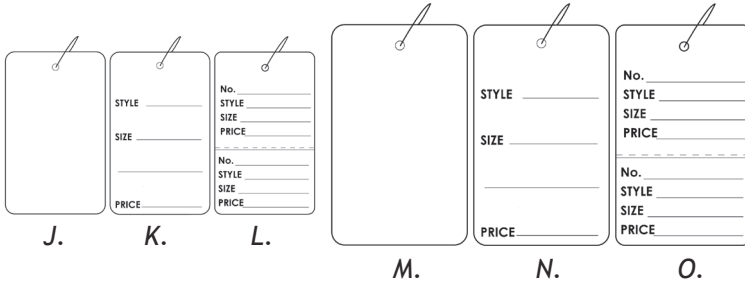
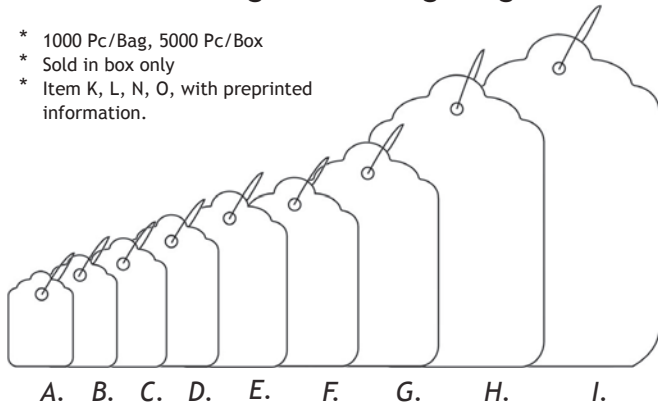

Blank White Tags are available with and without string. They are perfect for displaying price, codes, and product information.

	With String	No String		
	Item	Item	Size: W x H	(mm)
A.	TA1311	TA1301	5/8" x 15/16"	(16 x 24)
B.	TA1312	TA1302	3/4" x 1 1/8"	(19 x 28)
C.	TA1313	TA1303	7/8" x 1 1/4"	(22 x 32)
D.	TA1314	TA1304	15/16" x 1 1/2"	(24 x 38)
E.	TA1315	TA1305	1 1/8" x 1 3/4"	(28 x 44)
F.	TA1316	TA1306	1 1/4" x 1 7/8"	(32 x 47)
G.	TA1317	TA1307	1 7/16" x 2 3/16"	(36 x 56)
H.	TA1318	TA1308	1 3/4" x 2 7/8"	(44 x 73)
I.	TA1319	TA1309	2" x 3 1/4"	(51 x 82)
J.	TA1501	TA0501	1 1/4" x 1 7/8"	(32 x 47)
K.	TA1511	TA0511	1 1/4" x 1 7/8"	(32 x 47)
L.	TA1531	TA0531	1 1/4" x 1 7/8"	(32 x 47)
M.	TA1500	TA0500	1 3/4" x 2 7/8"	(44 x 73)
N.	TA1510	TA0510	1 3/4" x 2 7/8"	(44 x 73)
O.	TA1530	TA0530	1 3/4" x 2 7/8"	(44 x 73)

All-Purpose Unstrung Tags

- * Provide at a glance inventory by using different color tags per month.
- * Each color comes in 2 different sizes
- * Attaches easily with a tagging gun.
- * 1000 Pc/Box

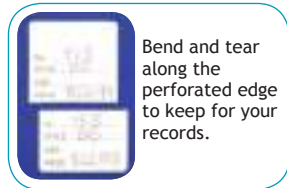

TA0531 (Color)
1 1/4" x 1 7/8" (32 x 47mm)



TA0530 (Color)
1 3/4" x 2 7/8" (44 x 73mm)

Available Colors



Sale Price Tags

- * Available in both strung and unstrung
- * 1000 Pc/Box



TA0541
Without String
1 1/4" x 1 7/8" (32 x 47mm)



TA1328
Without String

TA1338
With String



TA1326
Without String

TA1336
With String

Center-Slit Tags

- * Slotted tags slip over existing tags, knobs, buttons, ect., to create an instant "sale".
- * Bold message, printed one sided, with reinforced hole for optional string.

2 3/8" x 4 3/4" (140 x 178mm) 1000 Tags/Box



TA2522



TA2523



TA2524



Slip over existing tags!

■ Sales Order Books

* Comes in book of 50 sets.



2-Part Carbonless



F213
5 9/16" x 8 7/16"
(141 x 214mm)

F212
4 3/16" x 7 3/16"
(106 x 183mm)

F211
3 11/32" x 5 5/8"
(85 x 143mm)

3-Part Carbonless



F213-1
5 9/16" x 8 7/16"
(141 x 214mm)

F212-1
4 3/16" x 7 3/16"
(106 x 183mm)

F211-1
3 11/32" x 5 5/8"
(85 x 143mm)

■ Invoice Books

* Comes in book of 50 sets.



2-Part Carbonless



F224
8 1/2" x 11"
(216 x 279mm)

F223
5 9/16" x 8 7/16"
(141 x 214mm)

3-Part Carbonless



F224-1
8 1/2" x 11"
(216 x 279mm)

F223-1
5 9/16" x 8 7/16"
(141 x 214mm)

■ Tissue Paper Cutter



* Tissue paper not included

PA100
9" x 3 1/8" x 8 1/2"
(255 x 80 x 215mm)

■ Purchase Order Books

* Comes in book of 50 sets.



F234-1
8 1/2" x 11" (216 x 279mm)

3-Part Carbonless



■ Clear Sealing Tape

* Ideal for most shipping needs



A27
2" x 110" Yard

■ Computer Paper

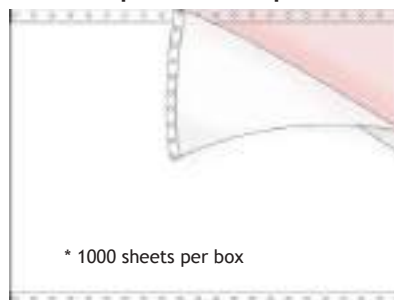

CPAPER -E2

* Carbonless computer paper with regular perforations feeds smoothly through printers. 2-part multicolor is white and pink.

* 1000 sheets per box

Chain Hook

- * The chain hook can be used with suction cup to keep chains neatly together.

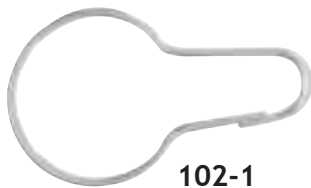

102-1
Chain Hook
2 5/8" x 1 1/2"
(68 x 38mm)



50 Pcs/Box

Suction Cup

- * Hang signs or displays



BX228-1
Small Suction Cup
7/8" Dia. (21mm)



BX228
Large Suction Cup
1 5/8" Dia. (42mm)

Plastic Swivel Clip

- * Overall dimension 2"H x 5/8" (51 x 16mm)
- * Great for display signs and a variety of merchandise
- * This clip has great holding power and twists in any direction
- * The loop can be snapped onto wire grid, bag hooks, wire baskets.



NEW

S12-0512-11
Black Plastic

S12-0512-10
White Plastic

50 Pc/Bag
10 Bag/Box
Sold in box only

Jewelry Display Pins

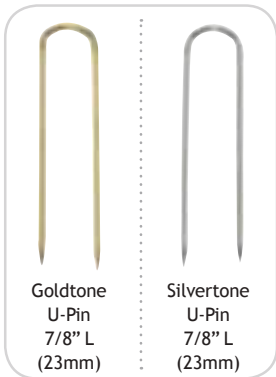

Goldtone
U-Pin
7/8" L
(23mm)

Silvertone
U-Pin
7/8" L
(23mm)



19-SH
Silver U-Pin (100pc/pk)



19-S
Silver U-Pin (1000pc/pk)



19-H
Gold U-Pin (100pc/pk)



19
Gold U-Pin (1000pc/pk)



Display w/ u-pin

Price Tag Gun

- * Tacked with needle guard
- * Includes a steel needle



F-6011
Standard Tagging Gun

Fasteners

F-6123
3" Fastener-Clear



F-6151
C-Hook Fastener

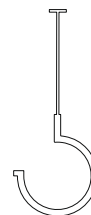

F-6121
1" Fastener-Clear



Denim Apron



T38-3061

2 Pocket Cotton
Full Length
Denim Apron

28" x 37 3/8"
(71 x 95cm)

Manual Tag Attacher Fasteners

- * 1000 Pc/Bag, 5000 Pc/Box
- * Sold in box only.

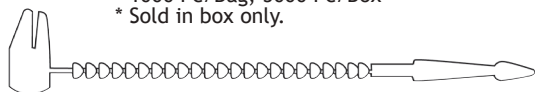

F-6145
Beaded Loop Lock
5" L



Long lasting,
simply push end
into locked barrel
to lock into place.
Plastic snap-on
strings for manual
use.

Injection Molded Body Forms

- * Opaque finish with swivel hook
- * Injection-molded sturdy plastic construction
- * Open hollow back shell for easy stackable storage
- * Light weight and easy clean

Available Opaque Color:

White
-10

Black
-11

Swivel
Hook
for easy
hooking!

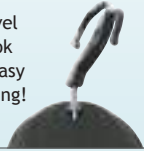

NEW



S45-4201-Color
Fits Men's Size S-L

S45-2205-Color
Fits Women's Size 5-10

S45-4103-Color
Men's Half Body

S45-2101-Color
Fits Women's Size 5-10

Adjustable Metal Base

NEW

Perfect for display
plastic form. Plastic
form sold separately.

Adjustable from 19"-38"



S24-1938-13
Chrome Metal Base

Store Supplies Collection

244

Molded PVC Forms

- * Open hollow back shell for easy stackable storage
- * Light weight and easy clean

NEW



White PVC

White PVC

S46-1003-10
0-3 Years Old Kid Form

S46-1046-10
4-6 years Old Kid Form

S46-2017-19
Swimming Wear Form

Clear PVC



White Wire Vintage Dress Form

- * Decorative and functional
- * Display multiple types of merchandise
- * Use the shelf built into the bottom of torso to display coordinating pieces

NEW



Front

Back

S41-3001-10
White Wire Front

Adjustable Heights

- * Shoulder 15 3/8"
- * Hips 15"
- * Shelf 12 1/4" W x 12 3/4" H
- * Height 58 1/4" - 67 3/8" H

Jersey Form (PU) Mannequins

- * Exceptional adult jersey forms made of molded polyurethane foam covered with jersey material, adjustable height.
- * Easily pinnable for displaying or tailoring, assembly required.

Available Jersey Color:

Off White
-10

Black
-11



NEW

S41-4381-Color

Size: 38
Shoulders: 18"
Chest: 39"
Waist: 34"
Hips: 40"
Height: 28 1/2" H
Adjust Base: 26" to 40"



NEW

S41-2081-Color

Size: 8
Shoulders: 15"
Chest: 36"
Waist: 25"
Hips: 36"
Height: 28 3/8" H
Adjust Base: 26" to 40"

Available Jersey Color:

Off White
-10

Black
-11



NEW

S41-2261-Color

Women's Form

- * Size 6
- * Chest 33"
- * Waist 25 1/2"
- * Hips 34"
- * Height 30" H

Available Jersey Color:

Off White
-10

Black
-11



NEW

S41-2262-Color

Women's Form

- * Size 6
- * Chest 33"
- * Waist 25 1/2"
- * Hip 34"
- * Height 30" H

NEW

Available Jersey Color:

Black
-11

Off White
-10



S41-4385-Color

Men's Shirt Form

- * Size 38:
- * Shoulder 18"
- * Chest 37 1/2"
- * Waist 33 1/2"
- * Hips 36 1/2"
- * Body 22"H
- * Adjustable from 26" to 40"H

NEW

Available Jersey Color:

Black
-11

Off White
-10



S41-2085-Color

Women's Blouse Form

- * Size 8:
- * Shoulder 15"
- * Bust 36"
- * Waist 24 1/2"
- * Hips 35"
- * Body 23"H
- * Adjustable from 26" to 40"H

NEW

Available Jersey Color:

Black
-11

Off White
-10



S41-1031-Color

3 Year Old Child's Form

- * Chest 22 3/4"
- * Shoulder 9"
- * Waist 20 1/2"
- * Hips 23"
- * Body 17 1/2"H
- * Adjustable Base Stand

Adjustable Height Chrome Rack



- * Chrome finish, sturdy base.
- * Ship un-assembled

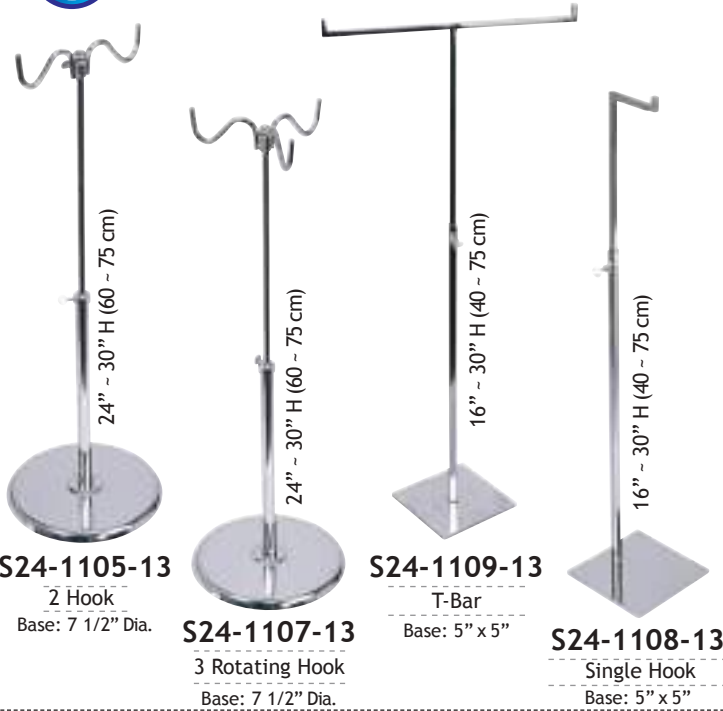

3 Tier Spinning Chrome Rack



- * Chrome finish, sturdy base.
- * Ship un-assembled

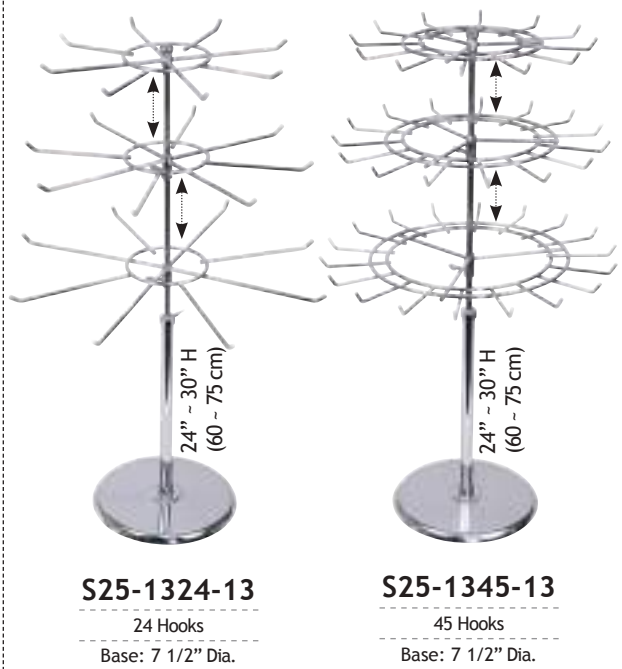

Rotating Earring Rack

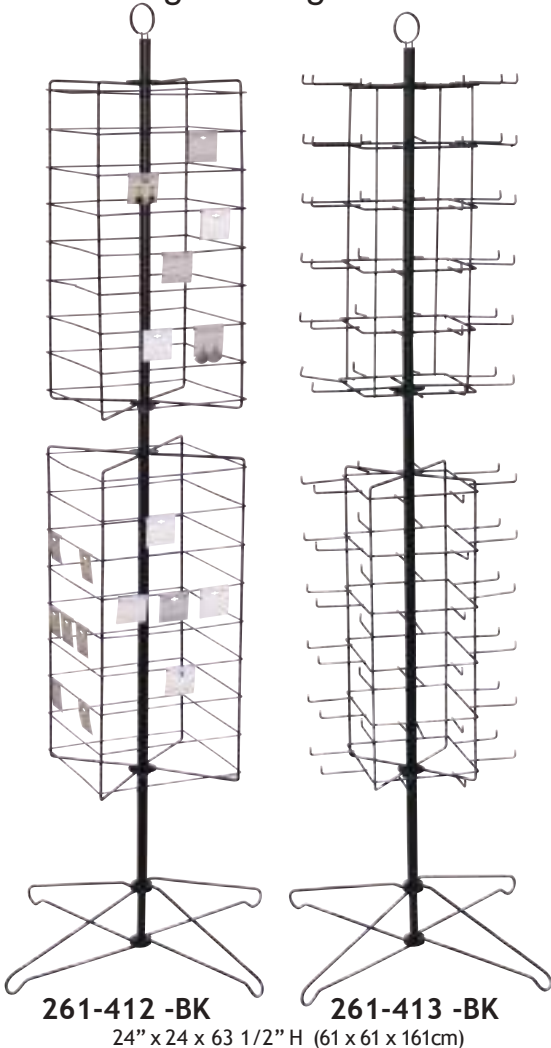

Rotating Hat Rack

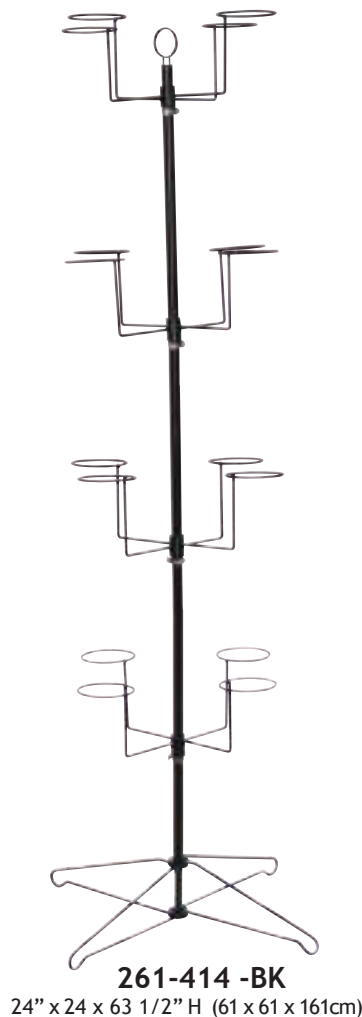
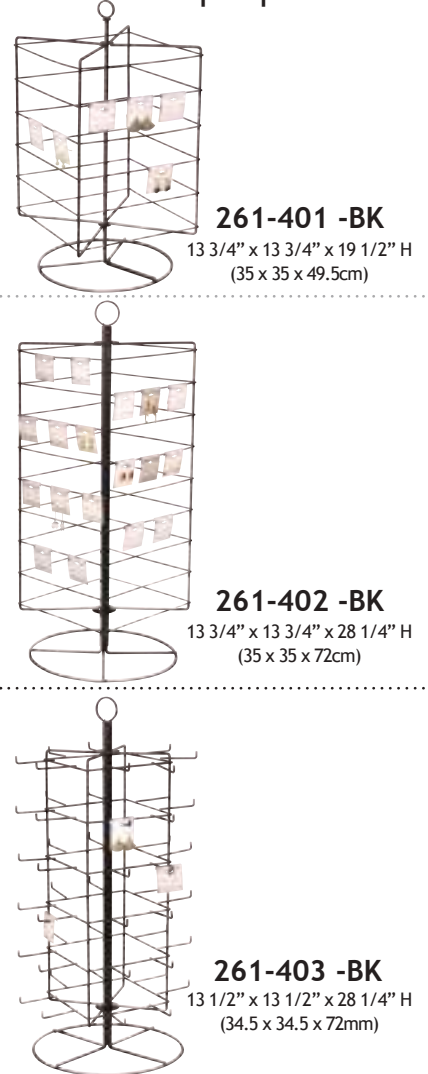

Table-Top Spinner



E-Cig Slot Ramp



E-Cig 18-Groove Tray Insert



E-Cig Flocked Tray Liner

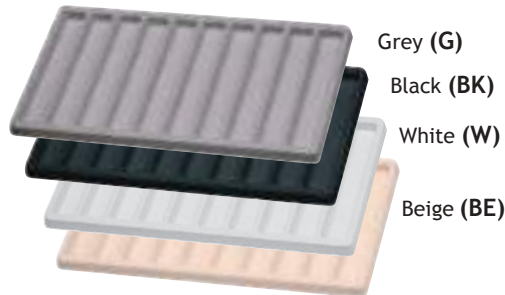

* Full tray insert can fit in our full size tray # TY-1021-BK.



* Half tray insert can fit in our half size tray # 2-1P (BK).



Full Size Tray Liner 14 1/8" L x 7 5/8" W x 1/2" H (360 x 194 x 13mm)

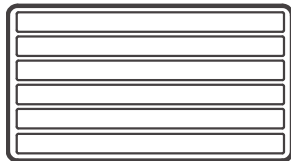

96-06 (Color)
Each Selection:
1" x 13 1/2"

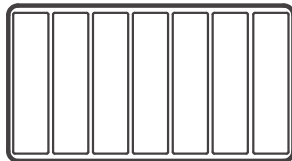

96-07 (Color)
Each Selection:
1 3/4" x 7"

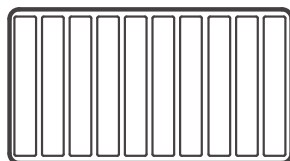

96-10 (Color)
Each Selection:
1 3/16" x 6 3/4"

Half Size Tray Liner
7 5/8" L x 6 3/4" W x 1/2" H
(195 x 170 x 13mm)

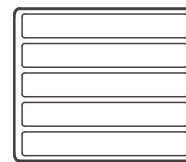

97-05 (Color)
Each Selection: 7" x 1"

Small Stackable Tray

Tray Size: 9" x 7 1/4" x 1 7/8" H (230 x 184 x 47mm)



E-Cig Acrylic Stand

NEW

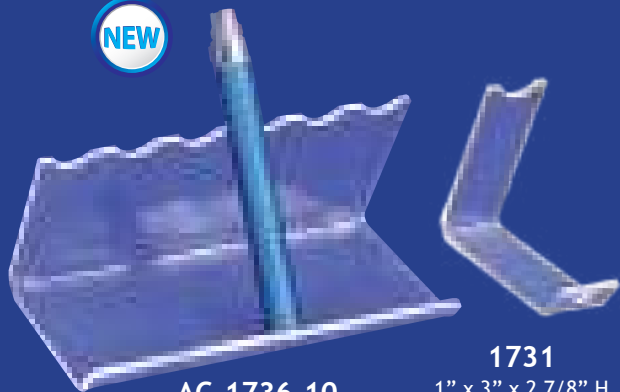

AC-1736-10
5 7/8" x 3" x 2 7/8" H
(150 x 76 x 73mm)

1731
1" x 3" x 2 7/8" H
(25 x 76 x 73mm)

AC-8922-10
Holds up to 22 Bottles
(1" Dia. Bottle)
7 7/8" x 6 1/4" x 2 1/8" H
(200 x 159 x 54mm)



NEW
2Tier

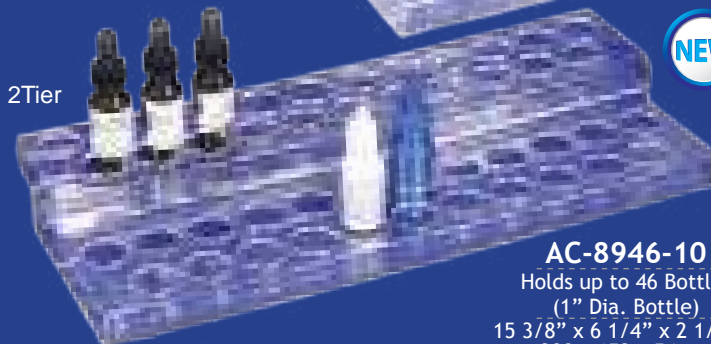

AC-8946-10
Holds up to 46 Bottles
(1" Dia. Bottle)
15 3/8" x 6 1/4" x 2 1/8" H
(390 x 159 x 54mm)

NEW

E-Cig Liquid Bottle Acrylic Stand

Vape Display Collection

248



5 Tier

AC-8330-10
Holds up to 30 Bottles
(1" Dia. Bottle)
6 3/8" x 6 1/8" x 7 3/8" H
(16.2 x 15.6 x 18.7cm)

NEW



5 Tier

AC-8390-10
Holds Up to 90 Bottles
(1" Dia. Bottle)
19" x 6 1/8" x 7 3/8" H
(48.3 x 15.6 x 18.7cm)

NEW

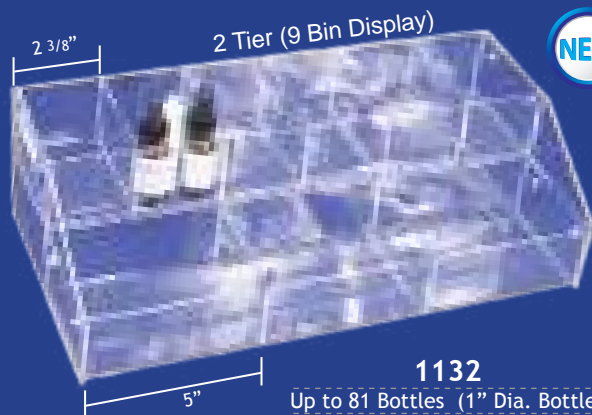

2 Tier (9 Bin Display)

2 3/8"

5"

1132
Up to 81 Bottles (1" Dia. Bottle)
16" x 8" x 4 5/8" H
(40.5 x 20 x 12cm)

NEW

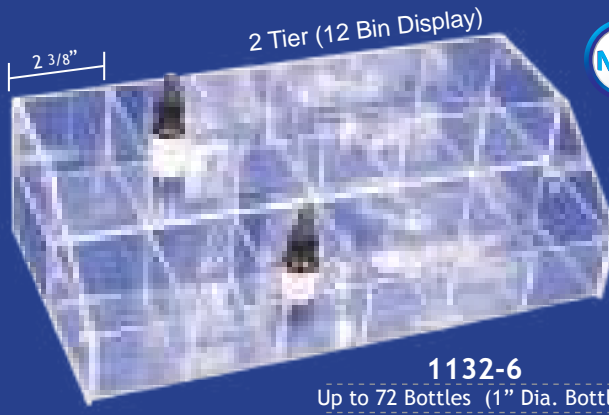

2 Tier (12 Bin Display)

2 3/8"

1132-6
Up to 72 Bottles (1" Dia. Bottle)
16" x 8" x 4 5/8" H
(40.5 x 20 x 12cm)

NEW

* Each bin accommodates up to 45 bottles (1" Dia. Bottle).

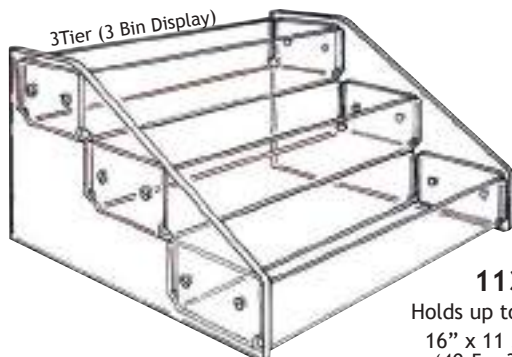

3Tier (3 Bin Display)

1133-1
Holds up to 135 Bottles
16" x 11 3/4" x 7" H
(40.5 x 30 x 18cm)

* Each bin accommodates up to 45 bottles (1" Dia. Bottle).

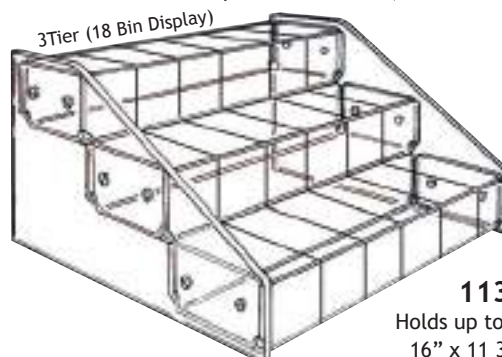

3Tier (18 Bin Display)

1133-6
Holds up to 108 Bottles
16" x 11 3/4" x 7" H
(40.5 x 30 x 18cm)

Round Metal Gem Jar w/ View-Top



Have Questions about our products?

 Call **(800) 433-5544**

 Click **www.aajewelry.com**



Jewelry Boxes
Bags & Pouches
Showcase Sets
Showcase Trays



Ring Displays
Figurines
Necklace Displays
Slatwall Displays
Bracelet Displays



T-Bars
Earring Displays
Mirrors
Acrylic Displays



Gem Displays
Storage Organizers
Salesman Supplies
Standard Trays



Tray Inserts
Watch Displays
Tool Supplies
Store Supplies
Vape Displays