

**can-am**



**MAVERICK SERIES**

# OPERATOR'S GUIDE

Includes Safety, Vehicle and Maintenance Information

**NO  
NO  
NO  
NO**

## **⚠ WARNING**

Read this operator's guide thoroughly. It contains important safety information.  
Minimum recommended operator age: 16 or older with a valid driver's license. Keep this operator's guide with the vehicle at all times.  
The removal or modification of evaporative emission-related parts on this OHRV is illegal. Violators may be subject to civil and/or criminal penalties under California and federal law.

---

219002167

**Original Instructions**

**⚠ WARNING**

**YOUR VEHICLE CAN BE HAZARDOUS TO OPERATE.** A collision or roll-over can occur quickly, if you fail to take proper precautions, even during routine maneuvers such as turning and driving on hills or over obstacles. For your safety, understand and follow all the warnings contained in this operator's guide and on the labels on your vehicle. Failure to follow these warnings can result in **SEVERE INJURY OR DEATH**. Keep this operator's guide with the vehicle at all times.

**⚠ WARNING**

Disregarding any of the safety precautions and instructions contained in the operator's guide, **SAFETY VIDEO** and on-product safety labels could cause injury including the possibility of death.

**⚠ WARNING**

This vehicle may exceed the performance of other vehicles you may have ridden in the past. Take time to familiarize yourself with your new vehicle.

## CALIFORNIA PROPOSITION 65 WARNING

**⚠ WARNING**

Operating, servicing and maintaining an off-road vehicle can expose you to chemicals including engine exhaust, carbon monoxide, phthalates, and lead, which are known to the State of California to cause cancer and birth defects or other reproductive harm. To minimize exposure, avoid breathing exhaust, do not idle the engine except as necessary, service your vehicle in a well-ventilated area and wear gloves or wash your hands frequently when servicing your vehicle. For more information go to [www.p65warnings.ca.gov/products/passenger-vehicle](http://www.p65warnings.ca.gov/products/passenger-vehicle).

TM® Trademarks of BRP or its affiliates.

This is a non-exhaustive list of trademarks that are the property of Bombardier Recreational Products Inc. or its affiliates:

Can-Am®

D.E.S.S.™

DPST™

XPS™

ROTAX®

Maverick™

X™

This document contains the trademarks of the following companies:

- † FOX is a trademark of Fox Factory, Inc.
- † QS3 is a trademark of Fox Factory, Inc.

All rights reserved. No parts of this Operator's guide may be reproduced in any form without the prior written permission of Bombardier Recreational Products Inc.

©Bombardier Recreational Products Inc. (BRP) 2021

BRP Inc.

Deutsch	Dieses Handbuch ist möglicherweise in Ihrer Landessprache verfügbar. Bitte wenden Sie sich an Ihren Händler oder besuchen Sie: <a href="http://www.operatorsguides.brp.com">www.operatorsguides.brp.com</a>
English	This guide may be available in your language. Check with your dealer or go to: <a href="http://www.operatorsguides.brp.com">www.operatorsguides.brp.com</a>
Español	Es posible que este manual esté disponible en su idioma. Consulte a su distribuidor o visite: <a href="http://www.operatorsguides.brp.com">www.operatorsguides.brp.com</a>
Français	Ce guide peut être disponible dans votre langue. Vérifier avec votre concessionnaire ou aller à: <a href="http://www.operatorsguides.brp.com">www.operatorsguides.brp.com</a>
Italiano	Questa guida potrebbe essere disponibile nella propria lingua. Contattare il concessionario o consultare: <a href="http://www.operatorsguides.brp.com">www.operatorsguides.brp.com</a>
中文	本手册可能有您的语种的翻译版本。请向经销商询问，或者登录 <a href="http://www.operatorsguides.brp.com">www.operatorsguides.brp.com</a> 查询。
日本語	このガイドは、言語によって翻訳版が用意されています。ディーラーに問い合わせるか、次のアドレスでご確認ください： <a href="http://www.operatorsguides.brp.com">www.operatorsguides.brp.com</a>
Nederlands	Deze handleiding kan beschikbaar zijn in uw taal. Vraag het aan uw dealer of ga naar: <a href="http://www.operatorsguides.brp.com">www.operatorsguides.brp.com</a>
Norsk	Denne boken kan finnes tilgjengelig på ditt eget språk. Kontakt din forhandler eller gå til: <a href="http://www.operatorsguides.brp.com">www.operatorsguides.brp.com</a>
Português	Este manual pode estar disponível em seu idioma. Fale com sua concessionária ou visite o site: <a href="http://www.operatorsguides.brp.com">www.operatorsguides.brp.com</a>
Русский	Воспользуйтесь руководством на вашем языке. Узнайте о его наличии у дилера или на странице по адресу <a href="http://www.operatorsguides.brp.com">www.operatorsguides.brp.com</a>
Suomi	Käyttöohjekirja voi olla saatavissa omalla kielelläsi. Tarkista jälleenmyyjältä tai käy osoitteessa: <a href="http://www.operatorsguides.brp.com">www.operatorsguides.brp.com</a>
Svenska	Denna bok kan finnas tillgänglig på ditt språk. Kontakta din återförsäljare eller gå till: <a href="http://www.operatorsguides.brp.com">www.operatorsguides.brp.com</a>

Covered Models
Maverick DS Turbo
Maverick DS Turbo RR
Maverick X ds Turbo RR
Maverick RS Turbo RR
Maverick X rs Turbo RR
Maverick X rs Turbo RR with Smart-Shox
Maverick X rc Turbo RR 64 in
Maverick X rc Turbo RR 72 in

In Canada, products are distributed and serviced by Bombardier Recreational Products Inc. (BRP).

In the USA, products are distributed and serviced by BRP US Inc.

In the European Economic Area (which is comprised of the member states of the European Union plus the United Kingdom, Norway, Iceland and Liechtenstein), the Commonwealth of the Independent States (including Ukraine and Turkmenistan) and Turkey, products are distributed and serviced by BRP European Distribution S.A. and other affiliates or subsidiaries of BRP.

For all other countries, products are distributed and serviced by Bombardier Recreational Products Inc. (BRP) or its affiliates.

---

# TABLE OF CONTENTS

## GENERAL INFORMATION

<b>GENERAL INFORMATION</b> .....	<b>10</b>
Know Before you Go .....	10
Safety Messages .....	10
About this Operator's Guide.....	10

## SAFETY INFORMATION

<b>GENERAL PRECAUTIONS</b> .....	<b>14</b>
Avoid Carbon Monoxide Poisoning.....	14
Avoid Gasoline Fires and Other Hazards .....	14
Avoid Burns from Hot Parts .....	14
Accessories and Modifications .....	14
<b>SAFE OPERATION - RESPONSIBILITIES</b> .....	<b>16</b>
Owner - Be Responsible.....	16
Operator - Be Qualified and Responsible .....	16
Riding Carefully .....	17
Occupant Restraint System .....	17
Terrain Condition .....	17
<b>PRE-RIDE INSPECTION</b> .....	<b>19</b>
Pre-Ride Inspection Check List .....	19
<b>PREPARE TO RIDE</b> .....	<b>22</b>
Before You Ride .....	22
Riding Gear.....	22
<b>AVOID ACCIDENTS</b> .....	<b>24</b>
Avoid Rollovers and Tipovers .....	24
Avoid Collisions .....	25
<b>RIDING YOUR VEHICLE</b> .....	<b>26</b>
Practice Exercises .....	26
Off-Road Operation .....	27
General Riding Techniques .....	27
<b>MOVING LOADS AND DOING WORK</b> .....	<b>32</b>
Working with Your Vehicle.....	32
Carrying Loads.....	32
<b>IMPORTANT ON-PRODUCT LABELS (CANADA/UNITED STATES)</b> .....	<b>35</b>
Hang Tag.....	35
Safety Labels .....	36
Compliance Labels .....	44
Technical Information Labels .....	45
<b>IMPORTANT ON-PRODUCT LABELS (ALL COUNTRIES EXCEPT CANADA/UNITED STATES)</b> .....	<b>46</b>
Vehicle Safety Labels.....	46
Technical Information Labels .....	55
<b>REPORTING SAFETY DEFECTS</b> .....	<b>56</b>

## VEHICLE INFORMATION

<b>PRIMARY CONTROLS</b> .....	<b>58</b>
Steering Wheel.....	58
Accelerator Pedal .....	58

Brake Pedal .....	58
Shift Lever .....	59
<b>SECONDARY CONTROLS .....</b>	<b>61</b>
RF D.E.S.S Key and RF D.E.S.S. Post .....	61
Engine Start/Stop Button .....	62
Headlight Dimmer Switch .....	62
2WD/4WD/Front Diff Lock (if Equipped) Switch .....	62
Riding Mode Switch .....	63
Keypad .....	63
Override Switch .....	64
Winch Switch (if Equipped) .....	64
Horn Switch (On Applicable Models) .....	65
Smart-Shox Suspension Mode Switch (On Applicable Models) .....	65
<b>4.5" DIGITAL DISPLAY .....</b>	<b>66</b>
Multifunction Display .....	66
Warning Lamps and Indicators .....	67
Settings .....	68
<b>7.6" DIGITAL DISPLAY (KEYPAD) .....</b>	<b>70</b>
Basic Functions .....	70
Settings .....	72
<b>EQUIPMENT .....</b>	<b>75</b>
Tilt Steering .....	76
Cup Holders .....	77
Passenger Handholds .....	77
Glove Box .....	77
Tool Kit .....	77
Footrests .....	77
Doors .....	78
Seat Belts .....	78
Seats .....	80
Fuel Reservoir Cap .....	83
Cargo Rack .....	83
Recovery Hook .....	83
Wheel Scraper .....	84
12-Volt Power Outlet .....	84
Central Rearview Mirror .....	84
Rock Sliders and Suspension Arm Protectors (if Equipped) .....	85
Winch (If Equipped) .....	85
<b>TUNE YOUR RIDE .....</b>	<b>87</b>
DPS Function .....	87
Suspension Adjustment Guidelines .....	87
Suspension Factory Settings .....	89
Suspension Adjustments .....	92
<b>FUEL .....</b>	<b>96</b>
Fuel Requirements .....	96
Vehicle Fueling Procedure .....	96
<b>BREAK-IN PERIOD .....</b>	<b>98</b>
Operation During Break-In .....	98
<b>BASIC PROCEDURES .....</b>	<b>99</b>
Starting the Engine .....	99
Waking Up the Electrical System .....	99
Operating the Shift Lever .....	99

Choosing the Correct Range (Low or High)..... 99  
 Stopping the Engine and Parking the Vehicle..... 100  
 Tips for Maximizing Drive Belt Durability..... 101  
**SPECIAL PROCEDURES ..... 102**  
 What to do if Water Entered the CVT..... 102  
 What to do if Battery is Drained Out..... 102  
 What to Do if Vehicle Rolled Over ..... 102  
 What to do if Vehicle is Submerged..... 102  
**TRANSPORTING THE VEHICLE ..... 103**  
 Using Vehicle Power to Climb Onto Trailering Equipment ..... 103  
 Using a Winch to Pull Vehicle Onto Trailering Equipment..... 104  
 Securing Vehicle for Transport..... 105  
 Getting Vehicle Out of Trailer..... 105  
**LIFTING AND SUPPORTING THE VEHICLE ..... 106**  
 Front of Vehicle ..... 106  
 Rear of Vehicle..... 106

**MAINTENANCE**

**MAINTENANCE SCHEDULE ..... 108**  
 EPA Regulation - Canadian and USA Vehicles ..... 108  
 Air Filter Maintenance Guideline ..... 108  
 Severe Duty Use ..... 109  
 Deep Mud / Water Use..... 110  
 Maintenance Schedule..... 110  
**MAINTENANCE PROCEDURES ..... 118**  
 Engine Air Filter ..... 118  
 Front Grille Kit ..... 119  
 CVT Air Filter..... 119  
 Evaporative Emission System Pre-Filter (If Equipped) ..... 120  
 Engine Oil ..... 121  
 Oil Filter ..... 123  
 Radiator..... 124  
 Engine Coolant..... 124  
 Muffler and Spark Arrester..... 127  
 Front Differential..... 127  
 Gearbox..... 128  
 Spark Plugs..... 130  
 CVT Cover ..... 133  
 Drive Belt ..... 134  
 Drive and Driven Pulleys ..... 135  
 Battery ..... 136  
 Fuses ..... 136  
 Lights..... 138  
 Drive Shaft Boot ..... 138  
 Wheel Bearing..... 139  
 Wheels and Tires..... 139  
 Suspensions ..... 142  
 Brakes ..... 144  
 Seat Belts ..... 144  
 Cage ..... 145

<b>VEHICLE CARE</b> .....	<b>146</b>
Post-Operation Care .....	146
Vehicle Cleaning and Protection .....	146
<b>STORAGE AND PRESEASON PREPARATION</b> .....	<b>147</b>

**TECHNICAL INFORMATION**

<b>VEHICLE IDENTIFICATION</b> .....	<b>150</b>
Vehicle Identification Number .....	150
Engine Identification Number.....	150
Compliance Label.....	150
<b>RADIO FREQUENCY DIGITALLY ENCODED SECURITY SYSTEM (RF D. E.S.S. KEY)</b> .....	<b>151</b>
<b>EVAPORATIVE EMISSION CONTROL SYSTEM</b> .....	<b>152</b>
<b>NOISE EMISSION CONTROL SYSTEM REGULATION</b> .....	<b>153</b>
<b>EC-DECLARATION OF CONFORMITY</b> .....	<b>154</b>
<b>EAC DECLARATION OF CONFORMITY</b> .....	<b>156</b>

**TECHNICAL SPECIFICATIONS**

<b>TECHNICAL SPECIFICATIONS</b> .....	<b>158</b>
---------------------------------------	------------

**TROUBLESHOOTING**

<b>TROUBLESHOOTING GUIDELINES</b> .....	<b>172</b>
<b>MESSAGES IN MULTIFUNCTION GAUGE</b> .....	<b>176</b>

**WARRANTY**

<b>BRP LIMITED WARRANTY USA AND CANADA: 2022 CAN-AM® SSV</b> ..	<b>178</b>
1) SCOPE OF THE LIMITED WARRANTY .....	178
2) LIMITATIONS OF LIABILITY .....	178
3) EXCLUSIONS – ARE NOT WARRANTED .....	178
4) WARRANTY COVERAGE PERIOD .....	179
5) CONDITIONS TO HAVE WARRANTY COVERAGE.....	179
6) WHAT TO DO TO OBTAIN WARRANTY COVERAGE .....	180
7) WHAT BRP WILL DO.....	180
8) ADDITIONAL SUPPLIER WARRANTIES .....	180
9) TRANSFER.....	180
10) CONSUMER ASSISTANCE .....	180
<b>US EPA EMISSION - RELATED WARRANTY</b> .....	<b>181</b>
Emission-Related Warranty Period .....	181
Components Covered.....	181
Limited Applicability .....	182
<b>CALIFORNIA EVAPORATIVE EMISSIONS CONTROL WARRANTY STATEMENT</b> .....	<b>184</b>
Your Warranty Rights And Obligations .....	185
OHRV Manufacturer’s Warranty Coverage .....	185
Owner’s Warranty Responsibilities.....	186



**BRP INTERNATIONAL LIMITED WARRANTY: 2022 CAN-AM® SSV ..... 187**

1) SCOPE OF THE LIMITED WARRANTY ..... 187

2) LIMITATIONS OF LIABILITY ..... 187

3) EXCLUSIONS ARE NOT WARRANTED ..... 187

4) Warranty Coverage Period ..... 188

5) CONDITIONS TO HAVE WARRANTY COVERAGE..... 189

6) WHAT TO DO TO OBTAIN WARRANTY COVERAGE ..... 189

7) WHAT BRP WILL DO ..... 190

8) TRANSFER..... 190

9) CONSUMER ASSISTANCE ..... 190

**BRP LIMITED WARRANTY FOR THE EUROPEAN ECONOMIC AREA,  
THE COMMONWEALTH OF THE INDEPENDENT STATES AND TURKEY:  
2022 CAN-AM® SSV ..... 191**

1) SCOPE OF THE LIMITED WARRANTY ..... 191

2) LIMITATIONS OF LIABILITY ..... 191

3) EXCLUSIONS – ARE NOT WARRANTED ..... 192

4) WARRANTY COVERAGE PERIOD ..... 192

5) CONDITIONS TO HAVE WARRANTY COVERAGE..... 193

6) WHAT TO DO TO OBTAIN WARRANTY COVERAGE ..... 193

7) WHAT BRP WILL DO ..... 193

8) TRANSFER..... 194

9) CONSUMER ASSISTANCE ..... 194

**MAINTENANCE RECORDS ..... 196**

***CUSTOMER INFORMATION***

**PRIVACY INFORMATION ..... 202**

**CONTACT US ..... 203**

    Asia ..... 203

    Europe ..... 203

    North America ..... 203

    Oceania ..... 203

    South America ..... 203

**CHANGE OF ADDRESS AND OWNERSHIP ..... 204**

This page is intentionally blank

# GENERAL INFORMATION

# GENERAL INFORMATION

Congratulations on your purchase of a new Can-Am® side-by-side vehicle. It's backed by the BRP limited warranty and a network of authorized Can-Am Off-road dealers ready to provide the parts, accessories or service you may require.

At delivery, you were informed of the warranty coverage and signed the Pre-delivery Check List to ensure your new vehicle was prepared to your entire satisfaction.

Your dealer is committed to your satisfaction. If you need more information, please ask your dealer.

## Know Before you Go

To learn how to reduce the risk of accident for you or bystanders, read this Operator's Guide before you operate the vehicle.

Also, read all safety labels on your vehicle and watch the *Safety Video* located at:

[https://can-am.brp.com/off\\_road/safety](https://can-am.brp.com/off_road/safety)

Or use the following QR code.



This vehicle is for off-road use only. It is mainly for general recreational use but it may also be used for utility purposes.

Failure to follow the warnings contained in this Operator's Guide can result in **SERIOUS INJURY** or **DEATH**.

## Safety Messages

The types of safety messages, what they look like and how they are used in this guide are explained as follows:

The safety alert symbol  indicates a potential injury hazard.

### **WARNING**

**Indicates a potential hazard which, if not avoided, could result in serious injury or death.**

### **CAUTION**

**Indicates a hazardous situation which, if not avoided, could result in minor or moderate injury.**

### **NOTICE**

**Indicates an instruction which, if not followed, could result in severely damaged vehicle components or other property.**

## About this Operator's Guide

This Operator's Guide has been prepared to acquaint the owner/operator of a new vehicle with the various vehicle controls, maintenance and safe operating instructions. It is indispensable for the proper use of the product.

Keep this Operator's Guide in the vehicle as you can refer to it for things such as maintenance, troubleshooting and instructing others.

Note that this guide is available in several languages. In the event of any discrepancy, the English version shall prevail.

If you want to view and/or print an extra copy of your Operator's Guide, simply visit the following website:

**[www.operatorsguides.brp.com](http://www.operatorsguides.brp.com)**

The information contained in this document is correct at the time of

publication. BRP, however, maintains a policy of continuous improvement of its products without imposing upon itself any obligation to install them on products previously manufactured. Due to late changes, some differences between the manufactured product and the descriptions and/or specifications in this guide may occur. BRP reserves the right at any time to discontinue or change specifications, designs, features, models or equipment without incurring any obligation upon itself.

This Operator's Guide should remain with the vehicle when it is sold.

This page is intentionally blank

# **SAFETY INFORMATION**

---

# GENERAL PRECAUTIONS

## Avoid Carbon Monoxide Poisoning

All engine exhaust contains carbon monoxide, a deadly gas. Breathing carbon monoxide can cause headaches, dizziness, drowsiness, nausea, confusion and eventually death.

Carbon monoxide is a colorless, odorless, tasteless gas that may be present even if you do not see or smell any engine exhaust. Deadly levels of carbon monoxide can collect rapidly, and you can quickly be overcome and unable to save yourself. Also, deadly levels of carbon monoxide can linger for hours or days in enclosed or poorly ventilated areas. If you experience any symptoms of carbon monoxide poisoning, leave the area immediately, get fresh air and seek medical treatment.

To prevent serious injury or death from carbon monoxide:

- Never run the vehicle in poorly ventilated or partially enclosed areas such as garages, carports or barns. Even if you try to ventilate engine exhaust with fans or open windows and doors, carbon monoxide can rapidly reach dangerous levels.
- Never run the vehicle outdoors where engine exhaust can be drawn into a building through openings such as windows and doors.

## Avoid Gasoline Fires and Other Hazards

Gasoline is extremely flammable and highly explosive. Fuel vapors can spread and be ignited by a spark or flame many feet away from the engine. To reduce the risk of fire or explosion, follow these instructions:

- Use only an approved gasoline container to store fuel.

- Never fill the gasoline container on the vehicle - an electrical static discharge may ignite the fuel.
- Never carry gasoline container(s) or any dangerous liquids on the cargo rack.
- Strictly adhere to instructions in *Vehicle Fueling Procedure*.
- Never start or operate the engine if the fuel cap is not properly installed.

Gasoline is poisonous and can cause injury or death.

- Never siphon gasoline by mouth.
- If you swallow gasoline, get any in your eye(s), or inhale gasoline vapor, see a doctor immediately.

If gasoline spills on you, wash with soap and water and change your clothes.

## Avoid Burns from Hot Parts

Certain components like brake rotors and exhaust components become hot during operation. Avoid contact with those parts during and shortly after operation to avoid burn wounds.

## Accessories and Modifications

Any modifications or addition of accessories approved by BRP may affect the handling of your vehicle. It is important to take the time to get familiar with the vehicle once modifications are made to understand how to adapt your driving behavior accordingly.

Avoid installing equipment not specifically approved by BRP for the vehicle and avoid unauthorized modifications. These modifications and equipment have not been tested by BRP and may create hazards. For example, they could:

- Create a loss of control and increase risk of crash



- Cause overheating or short circuits increasing the risk of fire or burn injuries
- Affect the protection features provided by the vehicle.

Your vehicle may also become illegal to ride.

As an example, installing an additional GPS or cell phone support may prevent the driving capabilities of the vehicle and increase the risk of a loss of control.

**Ask your authorized BRP dealer for suitable available accessories for your vehicle.**

---

# SAFE OPERATION - RESPONSIBILITIES

This is a high performance off-road vehicle. Operators must be responsible and use care to avoid rollovers, tipovers, collisions, and other accidents. Even with vehicle safety features (such as protective structure, seat belts, doors) and protective gear (such as a helmet), there is always a risk of injury or death in these accidents. To reduce the risk of serious injury or death, follow the rules in this section.

## Owner - Be Responsible

Read this Operator's Guide and watch the *Safety Video*. Refer to the link at the beginning of the Operator's Guide.

Always inspect and confirm the safe operating condition of your vehicle prior to ride. Always follow the maintenance schedule described in this Operator's Guide.

Never allow anyone to operate your vehicle unless they are responsible and can be trusted with a high performance vehicle. Consider supervising new or young operators and setting rules and limits (e.g., whether they can carry a passenger, what they may do with the vehicle, where they may ride, etc.) for anyone using your vehicle.

Select the appropriate key (see *RF D. E. S. S Key and RF D. E. S. S. Post*) based on the operator's experience, vehicle use and environment.

Discuss the safety information with anyone who will be using the vehicle. Be sure that all operators and passengers meet the qualifications below and agree to follow the safety information. Help users become familiar with the vehicle.

We encourage you to have an Annual Safety Inspection of your vehicle. Please contact an authorized BRP dealer for further details. Though not required, it is recommended that an authorized BRP dealer performs the

preseason preparation of your vehicle. Each visit to your authorized BRP dealer is a great opportunity for your dealer to verify if your vehicle is included in any safety campaign. We also urge you to visit your authorized BRP dealer in a timely manner if you become aware of any safety related campaigns.

## Operator - Be Qualified and Responsible

Read this Operator's Guide and watch the safety video. Refer to the link at the beginning of the Operator's Guide.

Become completely familiar with the operational controls and the general operation of the vehicle.

Get familiar with this Off-Highway Vehicle (OHV); it may exceed the performance of other OHV you may have ridden. This is a high performance vehicle. Inexperienced riders may overlook risks and be surprised by the specific behavior of this vehicle in any terrain condition.

Take a training course if available (contact an authorized Can-Am Off-road dealer to find out about training course availability as well as on the internet at <http://www.rohva.org/>), and perform the practice exercises in *Practice Exercises*. Practice driving in a suitable area free of hazards and feel the response of each control. Drive at low speeds. Higher speeds require greater experience, knowledge and suitable riding conditions.

Be at least 16 years of age.

Be tall enough to be properly seated: back against the backrest with the seat belt fastened, to hold the steering wheel with both hands and still be able to reach the full stroke of brake and accelerator pedals with the right foot and to firmly plant left foot on the footrest.

Have a proper driver's license in accordance with local laws.

Never use this vehicle with drugs or alcohol, or if tired or ill. These slow reaction time and impair judgment.

### **Carrying Passenger**

Only carry one passenger. The passenger must be properly seated in the cockpit.

The passenger must be tall enough to always be properly seated: back against the backrest with seat belt fastened, holding both handholds, and feet firmly planted on the footrests.

Never carry a passenger who has used drugs or alcohol, or is tired or ill. These slow reaction time and impair judgment.

Instruct the passenger to read the vehicle's safety labels.

Never carry a passenger if you judge his ability or judgement insufficient to concentrate on the terrain conditions and adapt accordingly. More specifically for side-by-side vehicles, the passenger must also pay constant attention to the terrain ahead and be able to brace for bumps.

### **Riding Carefully**

- This vehicle handles differently from other vehicles. A collision or rollover can occur quickly, during abrupt maneuvers such as doing sharp turns, acceleration or deceleration and driving on hills or over obstacles, if you fail to take proper precautions.
- Never operate at excessive speeds. Always go at a speed that is proper for the terrain, visibility, and operating conditions, and your experience.
- Never attempt jumps, side slides, donuts or any other stunts.

- Never attempt rapid acceleration or deceleration when performing a sharp turn. This may result in a roll over.
- Never attempt skidding or sliding. If vehicle starts to skid or slide, counter steer in the direction of skidding or sliding. On extremely slippery surfaces, such as ice, go slowly and be very cautious in order to reduce the chance of skidding out of control.
- Always be sure there are no obstacles or people behind the vehicle when you operate in reverse. Pay attention to blind spots. When it is safe to proceed in reverse, go slowly.
- Never exceed the stated load limits for this vehicle. Reduce speed, allow for greater braking distance and follow other instructions in *Moving Loads and Doing Work*.
- Always remember that this vehicle is heavy! Its pure weight alone may entrap you should it tip or rollover.

### **Occupant Restraint System**

- This vehicle is designed to carry one driver and one passenger, both wearing proper protective gear. Refer to *Riding Gear* in this section.
- The driver and passenger must latch the doors and wear the seat belts at all times when riding.

### **Terrain Condition**

- Driving on public roads poses risks such as collisions and may be illegal in your jurisdiction. Only proceed with caution on roads and road segments where the usage of your vehicle is permitted.
- This vehicle is not designed to ride on paved surfaces; if you must shortly use the vehicle on such surfaces, avoid abrupt inputs to steering wheel, accelerator and brake pedals.

- Always go slowly and be extra careful when operating on unfamiliar terrain. Always be alert to changing terrain conditions when operating this vehicle. Take the time to learn how the vehicle performs in different environments.
- Never operate on excessively rough, slippery or loose terrain until you have learned and practiced the skills necessary to control this vehicle on such terrain. Always be especially cautious on these kinds of terrain.
- Never operate this vehicle on hills too steep for the vehicle or your abilities. Practice on small inclines.
- Always follow proper procedures for climbing or going down hills as described in *Riding Your Vehicle*. Check the terrain carefully before you start up or down any hill. Never climb or descend hills with excessively slippery or loose surfaces. Never go over the top of any hill at high speed.
- Never attempt steep hills or side hilling when pulling a trailer (if equipped with hitch).
- Always check for obstacles before operating in a new area. Always follow proper procedures when operating over obstacles as described in *Riding Your Vehicle*.
- Never operate this vehicle in fast flowing water or in water deeper than specified in *Riding Your Vehicle*. Remember that wet brakes may have reduced stopping ability. Test your brakes after leaving water. If necessary, apply them several times to let friction dry out the brakes.
- Always ensure to properly park the vehicle on the flattest terrain section available. Put shift lever in PARK, stop engine and remove key before leaving the vehicle.
- Never assume that the vehicle will go everywhere safely. Sudden changes in terrain caused by holes, depressions, banks, softer

or harder “ground” or other irregularities may cause the vehicle to topple or become unstable. To avoid this, slow down and always observe the terrain ahead. If the vehicle does begin to topple or roll-over, the best advice is to immediately steer in the direction of the rollover! Never attempt to prevent a rollover with your arms or legs. You should keep your limbs inside the cage.

# PRE-RIDE INSPECTION

Always inspect and confirm the safe operating condition of your vehicle prior to ride. Always follow the maintenance schedule described in this Operator's Guide.

<b>⚠ WARNING</b>
<b>Perform a pre-ride inspection before each ride to detect any potential problem that could occur during operation. The pre-ride inspection can help you monitor component wear and deterioration before they become a problem. Correct any problem that you discover to reduce the risk of a breakdown or crash.</b>

Before using this vehicle, the operator should always perform the following pre-ride inspection check list.

Refer to *Maintenance Procedures* for details.

## Pre-Ride Inspection Check List

### *What to Do Before Starting the Engine (Key OFF)*

ITEMS TO BE INSPECTED	INSPECTION TO PERFORM	✓
Tires	Check tire pressure and condition. Refer to <i>Technical Specifications</i> and adjust according to load.	
Wheels	Check wheels for damage and for abnormal play. Make sure that lug nuts and beadlocks screws (if equipped) are tightened. Refer to <i>Wheels and Tires</i> in <i>Maintenance Procedures</i> for torque specification.	
Radiator	Check radiator for cleanliness.	
Front grille	Inspect front grille kit for cleanliness.	
Engine oil	Check engine oil level.	
Coolant	Check coolant level.	
Brake fluid	Check brake fluid level.	
Engine air filter	Inspect engine air filter, replace if needed.	
Engine air filter housing	Inspect engine air filter housing and clean if necessary (when riding in dusty conditions or sand).	
CVT air filter	Inspect and clean the CVT air filter (when riding in dusty conditions).	
Drive shaft boots	Check drive shaft boots condition.	

ITEMS TO BE INSPECTED	INSPECTION TO PERFORM	✓
Cargo and load	<b>Cargo Load:</b> If you transport a cargo, respect the maximum cargo rack capacity. Refer to <i>Technical Specifications</i> . Ensure the weight of the operator, passengers, cargo, trailer tongue and added accessories does not exceed the vehicle total load allowed. Refer to <i>Technical Specifications</i> .	
	If you are pulling a trailer or another equipment (if equipped with a hitch): <ul style="list-style-type: none"> <li>– Check hitch and trailer ball condition.</li> <li>– Respect the tongue capacity and towing capacity as indicated on the label affixed to the hitch or refer to <i>Technical Specifications</i>.</li> <li>– Ensure trailer is properly secured to hitch.</li> </ul>	
Rear cargo rack	Check if the cargo on rack is properly secured.	
Chassis and suspension	Check underneath vehicle for any debris on chassis or suspension components (upper and lower arms, wheels, shock absorber, springs) and clean them properly.	

### What to Do Before Starting the Engine (Key ON)

ITEMS TO BE INSPECTED	INSPECTION TO PERFORM	✓
Gauge	Check operation of indicator lamps in gauge (With the D.E.S.S. key ON, briefly push the Start / Stop button).	
	Check for messages in gauge.	
Lights	Check operation and cleanliness of headlights and taillight.	
	Check operation of high and low beam.	
	Check operation of brake light.	

ITEMS TO BE INSPECTED	INSPECTION TO PERFORM	✓
Seats, doors and seat belts	Check seat adjustment and make sure locking device is properly engaged before riding.	
	Check doors for any damage. Have the doors replaced if any damage is found. Close both doors and confirm that they latch securely.	
	Check seat belts for any damage (including retractors, buckles and semi-cinching tabs). Fasten seat belts and ensure that they remain securely fastened and tightened against the body	
Accelerator pedal	Press on the accelerator pedal a few times to ensure it operates freely and it returns to the rest position when released.	
Brake pedal	Press down on the brake pedal and make sure you feel firm resistance and that it fully returns to position when released.	
Fuel level	Check the fuel level.	

### *What to Do After the Engine is Started*

ITEMS TO BE INSPECTED	INSPECTION TO PERFORM	✓
Steering	Check if steering operates freely by completely turning it from side to side.	
RF D.E.S.S. post	Check if D.E.S.S. post is working properly by pulling the D.E.S.S. key from D.E.S.S. post.	
Shift lever	Check operation of shift lever (P, R, N, H and L).	
2WD/4WD/Front Diff Lock (If equipped) selector	Check operation of 2WD/4WD/Front Diff Lock (If equipped) selector.	
Brakes	Drive forward slowly a few feet and apply brakes. The brake pedal must feel firm when applied. The pedal must return to rest position when released. The brakes must respond adequately to the driver's input.	

# PREPARE TO RIDE

## Before You Ride

Perform pre-ride inspection to confirm the safe operating condition of your vehicle. Refer to *Pre-Ride Inspection*.

Driver and passenger must:

- Be properly seated.
- Close both doors and fasten seat belts.
- Wear appropriate riding gear. (Refer to *Riding Gear* below.)

## Riding Gear

It is important that the operator and passenger always wears appropriate protective clothing and apparel, including:

- An approved helmet
- Eye protection
- Boots
- Gloves
- A long sleeved shirt or jacket
- Long pants.

Depending on conditions, anti-fogging goggles may be required.

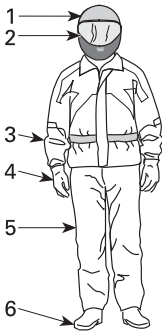

### RIDING GEAR

1. Approved helmet
2. Eye and face protection
3. Long sleeves shirt or jacket
4. Gloves
5. Long pants
6. Boots (over-the-ankle footwear)

Weather conditions should help you decide how to dress. To maximize comfort and avoid frostbites in winter, dress for the coldest weather

expected. Thermal underwear next to the skin also provides good insulation.

Never wear any loose clothing that may get entangled in the vehicle or on tree branches and shrubs.

## Helmets and Eye Protection

Helmets protect the head and brain from injury. Even with the vehicle's cage and doors, objects can enter the cockpit and strike the head, or the head can strike the cage itself or objects outside the vehicle. Even the best helmet is no guarantee against injury, but statistics indicate that helmet use significantly reduces the risk of brain injury. So, be safe and always wear a helmet while riding.

## Choosing a Helmet

Helmets should be manufactured to meet the appropriate standard in your state, province or country and should fit properly.

A helmet with face protection is a better choice as it protects also against frontal impacts. It can also protect against debris, stones, insects, the elements, etc.

An open-face helmet does not offer the same protection for the face and chin. If you wear an open-face helmet, you should use a snap-on face shield and/or a pair of goggles. Ordinary glasses or sunglasses are not sufficient eye protection for riders. They can shatter or fly off, and they allow wind and airborne objects to reach the eyes.

For winter riding conditions, a stocking type cap, balaclava and face mask should always be carried or worn.

Use tinted face shields or goggles in the daytime only; do not use them at night or in poor illumination. Do not use them if they impair your ability to discern color.



## **Other Riding Gear**

### **Footwear**

Always wear closed toe footwear. Sturdy over-the-ankle boots with non-slip soles offer more protection and allow you to plant your foot properly on footrest.

Avoid long shoelaces that can be tangled in the accelerator or brake pedals.

For winter riding conditions, rubber soled boots with either a nylon or leather uppers, with removable felt liners are best suited.

Avoid rubber boots. Rubber boots may get trapped behind or between pedals, impairing the proper operation of brake and accelerator pedals.

### **Gloves**

Full-fingered gloves protect hands from the wind, sun, heat, cold and flying objects. Gloves that fit snugly will improve grip on the steering wheel and help reduce hand fatigue. Sturdy, reinforced motorcycle or ATV gloves help protect hands better in the event of an accident or a rollover. If gloves are too bulky, it may be difficult to operate the controls.

For winter riding conditions, hands should be protected by a pair of snowmobile gloves which have sufficient insulation and allow use of thumbs and fingers for operation of controls.

### **Jackets, Pants and Riding Suits**

Wear a jacket or a long sleeved shirt and long pants, or a full riding suit. Quality ATV-type protective gear will provide comfort, and it can help you avoid being distracted by adverse environmental elements. In case of a crash, good quality protective gear made of sturdy material may prevent or reduce injury.

In cool-weather riding, protect yourself against hypothermia. Hypothermia, a condition of low body temperature, can cause loss of concentration, slowed reactions and loss of smooth, precise muscle movement. In cool conditions, proper protective gear like a windproof jacket and insulated layers of clothing are essential. Even while riding at moderate temperatures, you can feel very cold due to the wind.

Protective gear that is appropriate for cold-weather riding may be too hot when stopped. Dress in layers so that clothing can be removed as desired. Topping the protective gear with a windproof outer layer can prevent cold air from reaching the skin.

### **Rain Gear**

If you must ride in wet weather, a rain suit or a waterproof riding suit is recommended. On long rides, it is a good idea to carry rain gear. A dry rider will be much more comfortable and alert.

### **Hearing Protection**

Long-term exposure to wind and engine noise when riding can cause permanent hearing loss. Properly worn hearing protective devices such as earplugs can help prevent hearing loss. Check local laws before using any hearing protective devices.

---

# AVOID ACCIDENTS

## Avoid Rollovers and Tipovers

Side-by-side vehicles handle differently from other vehicles. Side-by-side vehicles are designed to handle off-road terrain (for example, their wheel base and track width, ground clearance, suspension, drivetrain, tires, etc.), and, as a result, can overturn in situations where vehicles designed for use primarily on paved or smooth terrain may not.

A rollover or other accident can occur quickly during abrupt maneuvers such as sharp turns or hard acceleration or deceleration when turning, or when driving on hills or over obstacles. Abrupt maneuvers or aggressive driving can cause rollovers or loss of control even in flat open areas. If the vehicle rolls over, any part of your body (such as arms, legs, or head) outside of the cockpit can be crushed and trapped by the cage or other parts of the vehicle. You can also be injured by impact with the ground, cockpit or other objects.

To reduce the risk of rollovers:

- Use care when turning.
  - Do not turn the steering wheel too far or too fast for your speed and environment. Adjust steering inputs according to your speed and environment.
  - Slow down before entering a turn. Avoid hard braking during a turn.
  - Avoid sudden or hard acceleration when turning, even from a stop or low speed.
- Never attempt donuts, skids, slides, fishtails, jumps, or other stunts. If vehicle starts to skid or slide, steer in the direction of the skid or slide. Never slam the brakes and lock the wheels.
- Avoid paved surfaces. This vehicle is not designed to operate on paved surfaces and is more likely to roll over. If you must drive on pavement, turn gradually, go

slowly, and avoid abrupt acceleration and braking.

This vehicle can roll over sideways or tip over forward or backwards on slopes or uneven terrain.

- Avoid side hilling (driving along the slope rather than up or down a hill). When possible, drive straight up and down inclines rather than across them. If you must side hill, use extreme caution and avoid slippery surfaces, objects, or depressions. If you feel the vehicle start to rollover or slide sideways, steer downhill if possible.
- Avoid steep hills and follow procedures in this guide for climbing and descending hills.
- Sudden changes in terrain such as holes, depressions, banks, softer or harder ground or other irregularities may cause the vehicle to tip or become unstable. Observe the terrain ahead and slow down in areas of uneven terrain.

This vehicle will handle differently when carrying or pulling a load.

- Reduce speed and follow instructions in this manual for carrying cargo or pulling a trailer.
- Avoid hills and rough terrain.
- Allow more distance to stop.

## Be Prepared in Case of Rollover

- Close both doors and fasten seat belt to help you avoid sticking out arms or legs.
- Never grab the cage while riding. Hands can be crushed between the cage and the ground in a rollover. Keep hands on the steering wheel or handholds.
- Never try to stop a rollover using your arms or legs. If you think that the vehicle may tip or roll, the driver should keep both hands on the steering wheel and the left foot firmly planted on the footrest. The passenger should keep both

hands on the handholds and both feet firmly planted on the floor.

## **Avoid Collisions**

This vehicle can reach high speeds. At higher speeds, there is an increased risk of losing control, particularly in challenging off-road conditions, and the risk of injury in a collision is greater. Never operate at excessive speeds. Always go at a speed that is proper for the terrain, visibility, and operating conditions, and your experience. Consider reserving use of the performance key for situations in which full speed and acceleration capability are appropriate.

Driving on public street, road or highway, even dirt or gravel ones poses risks such as collisions and may be illegal in your jurisdiction. Only proceed with caution on roads and road segments where the usage of your vehicle is permitted. This vehicle is not designed for operation on roads. For example, it does not meet motor vehicle safety standards that apply to automobiles. In many jurisdictions it is not legal to operate this vehicle on public roads.

This vehicle does not have the same kind of protection for collisions as a car; for example, there are no air bags, the cockpit is not fully enclosed, and it is not designed for collisions with other vehicles. Therefore, it is particularly important to fasten seat belts and close doors and wear an approved helmet.

---

# RIDING YOUR VEHICLE

## Practice Exercises

Before you go out for a ride, it is very important to familiarize yourself with the handling of your vehicle by practicing in a controlled environment. If possible, it is also a very good idea to take a more formal training course to sharpen your skills and increase your knowledge of the vehicle.

Find a suitable area to practice and perform the following exercises. It should be at least 45 m (150 ft) by 45 m (150 ft) free of obstacles like trees and rocks. Once you've selected a suitable permitted location, proceed with the following exercises.

### *Turning Exercises*

Turning is one of the most frequent causes of accidents. It is easier for the vehicle to lose traction or rollover if you turn too sharply, or go too fast. Slow down when you approach a turn.

- First learn how to perform slight right turns at very low speeds. Release the throttle before turning and slowly reapply the throttle when turning.
- Repeat turning exercise but this time maintain the throttle at the level while turning.
- Finally, repeat turning exercise while accelerating slowly.
- Practice exercises turning on the other side.

Note how your vehicle reacts in these different exercises. We recommend releasing the throttle before entering a turn to help initiate directional change. You will feel the lateral force increasing with the speed and with your steering input. The lateral force should be maintained as low as possible to make sure it does not cause the vehicle to roll over.

### *U Turn Exercises*

Practice doing U turns.

- Accelerate slowly and while remaining at low speed, then

gradually turn the steering wheel to the right until you have completed the U turn.

- Repeat U turn exercise with different steering inputs and always at a very low speed.
- Repeat U turn exercise on the other side.

As mentioned before in this guide, do not ride on paved surfaces as the vehicle behavior will not be the same, increasing the risk of rollover.

### *Braking Exercises*

Practice braking to get familiar with the brake response.

- Do it at low speed first, then increase the speed.
- Practice braking in straight line at different speeds and different braking force.
- Practice emergency braking; optimal braking is obtained in straight line, with high force applied, without locking the wheels.

Remember, braking distance depends on vehicle speed, load and the type of surface. Also, the tires and brakes conditions play a major role.

### *Reverse Exercises*

The next step involves using the reverse.

- Install 1 cone marker on both sides of the vehicle beside each rear wheel. Move the vehicle forward until you can see the cone markers, then stop the vehicle. Acknowledge the distance required to see obstacles behind you.
- Learn how the vehicle handles itself in reverse and reacts with steering inputs.
- Always perform this reverse exercise at slow speeds.
- Become familiar with the usage of the override function. Do not steer while using the override as it increases the risks of rollover.

## **Emergency Engine Stopping Exercise**

Learn how to stop your engine quickly in an emergency situation.

- While running at low speed, simply remove the RF D.E.S.S. key from the D.E.S.S. post.

This is to familiarize you with the vehicle's reaction when the engine is turned off while driving and to develop this reflex.

## **Off-Road Operation**

The very nature of off-road operation is dangerous. Any terrain, which has not been specially prepared to carry vehicles, presents an inherent danger where terrain substance, shape and steepness are unpredictable. The terrain itself presents a continual element of danger, which must be knowingly accepted by anyone venturing over it.

An operator who takes a vehicle off-road should always exercise the utmost care in selecting the safest path and keeping close watch on the terrain ahead of him. The vehicle should never be operated by anyone who is not completely familiar with the driving instructions applicable to the vehicle, nor should it be operated on steep or treacherous terrain.

## **General Riding Techniques**

### **General Driving Tips**

Care, caution, experience and driving skill are the best precautions against the hazards of vehicle operation.

Whenever there is the slightest doubt that the vehicle can safely negotiate an obstacle or a particular piece of terrain, always choose an alternate route.

In off-road operation, power and traction, not speed, are important. Never drive faster than visibility and your

own ability to select a safe route permit. Always go slowly and be extra careful when operating on unfamiliar terrain. Always be alert to changing terrain conditions when operating this vehicle. Be especially cautious on excessively rough, slippery, icy or loose terrain.

Constantly watch the terrain ahead for sudden changes in slopes or obstacles, such as rocks or stumps, that may cause loss of stability, resulting in tip over or rollover.

Never operate the vehicle if the controls do not function normally. See an authorized Can-Am Off-road dealer.

To maintain proper control it is strongly advised that you keep your hands on the steering wheel and within easy reach of all controls. The same holds true for your feet. To minimize the possibility of any leg or foot injury, keep your left foot on the footrest and right foot on the floor at all times. Staying completely within the cockpit will also help keep you from striking objects outside the vehicle.

Watch for and avoid branches and other objects that could enter the passenger compartment and strike you or your passengers.

### **Operating in Reverse**

When operating in reverse, check that the path behind the vehicle is free of people or obstacles. Pay attention to blind spots. When it is safe to proceed in reverse, go slowly and avoid sharp turns.

#### **⚠ WARNING**

**Steering inputs in reverse operation increase the risk of rollover.**

#### **NOTE:**

In reverse operation, the engine RPM is limited thus limiting the vehicle reverse speed.

**⚠ WARNING**

**When driving downhill in reverse, gravity can increase the vehicle speed above safe reverse speed.**

***Crossing Roads***

If you have to cross a road, ensure to have complete visibility on both sides for incoming traffic and decide on exit point on other side of road. Drive in a straight line toward that point. Do not make sharp direction changes or abrupt accelerations as it may result in a rollover situation. Do not travel on sidewalks or bicycle trails as they are designated specifically for those uses.

***Riding on Paved Surfaces***

Avoid paved surfaces. This vehicle is not designed to operate on paved surfaces and is more likely to roll over. If you must drive on pavement, turn gradually, go slowly, and avoid abrupt acceleration and braking.

***Shallow Water Crossing***

Water can be a unique hazard. If it is too deep the vehicle may “float” and topple. Check the water depth and current before you attempt to cross any water. Water depth should not exceed 30 cm (12 in) for vehicle to safely cross the obstacle. Beware of slippery surfaces such as rocks, grass, logs, etc., both in the water and on its banks. A loss of traction may occur. Do not attempt to enter the water at high speed.

Water will affect the braking ability of your vehicle. Make sure you dry the brakes by applying them several times after the vehicle leaves the water.

Mud or marsh lands may be encountered near water. Be prepared for sudden “holes” or changes in depth. Similarly so, be watchful of hazards such as rocks, logs, etc., partially covered by vegetation.

***Riding on Snow or Ice***

When performing pre-ride inspection, pay special attention to locations on the vehicle where snow and/or ice accumulations may obstruct visibility of the tail lamp, clog ventilation openings, block the radiator, fan, engine air intake and CVT air intake, and interfere with the movement of controls. Before starting with your vehicle, check the steering, accelerator and brake pedals for interference free operation.

Whenever this vehicle is ridden on a snow covered drive path, the tire grip is generally reduced causing the vehicle to react differently to control inputs from the operator. On low grip surfaces, the steering responses are not as crisp and precise, stopping distances are lengthened and acceleration is also affected. Slow down and do not “gun” the accelerator. This will only result in spinning of the tires and possibly in an over steering slide of the vehicle. Avoid hard braking. This will possibly result in a straight line slide of the vehicle. Again, the best advice is to safely reduce speed in anticipation of a maneuver to give yourself time and distance in order to keep control of the vehicle.

As you drive your vehicle over a loose snow covered surface, snow dust will be picked up in the wake turbulence of the moving vehicle and transported to contact and accumulate or melt on some exposed components including rotating parts like brake discs. Water, snow or ice may affect the response time of the brake system of your vehicle. Even when not required to reduce vehicle speed apply brakes frequently to prevent ice or snow accumulation and to dry brake pads and discs. While doing so in low risk driving situations you will test for grip level and keep yourself alerted to how the vehicle reacts to your control inputs. Always keep brake and accelerator

pedals and floor boards free of snow and ice. Frequently wipe snow off seat, steering wheel, headlights and tail lamps.

The depth of the snow cover may hide rocks, tree stumps or other objects and if it is wet may totally impede the drivability as the vehicle becomes bogged down or completely loses traction in slushy snow. Look far ahead and always be watchful of any visible clues that might indicate the presence of such obstacles. In doubt steer clear. Avoid driving on any frozen waterways before checking that the ice will safely support the vehicle, its riders and its load of cargo.

At the end of each ride it is a good practice to clean the vehicle and all moving components (brakes, steering components, drivelines, controls, radiator fan etc.) from any snow or ice accumulations. Wet snow will turn to ice during the shut down period and become more difficult to remove at the next pre-ride inspection.

### ***Riding on Sand***

Sand and riding on sand dunes is another unique experience but there are some basic precautions that should be observed. Wet, deep or fine sand may create a loss of traction and cause the vehicle to slide, drop off or become "bogged" down. If this occurs look for a firmer base. Again, the best advice is to slow down and be watchful of the conditions.

When riding in sand dunes it is advisable to equip the vehicle with an antenna type safety flag. This will help make your location more visible to others over the next sand dune. Proceed carefully should you see another safety flag ahead.

### ***Riding on Gravel, Loose Stones or Other Slippery Surfaces***

Riding on loose stones or gravel is very similar to riding on ice. They will affect the steering of vehicle, possibly causing it to slide and tip over especially at high speeds. In addition, braking distance may be affected. Remember that "gunning" the throttle or sliding may cause loose stones to be ejected rearwards into the path of another rider's way. Never do it deliberately.

If you do get into a slide or skid, it may help to turn the steering wheel into the direction of the skid until you regain control. Never jam the brakes and lock the wheels.

### ***Crossing Obstacles***

Use the low range (L) for crossing obstacles.

Obstacles on the "trail" should be traversed with caution. This includes rocks, fallen trees, and depressions. You should avoid them whenever possible. Remember that some obstacles are too large or dangerous to cross and should be avoided. As a guideline, never attempt to cross an obstacle higher than the ground clearance of the vehicle. Small rocks or small fallen trees may be safely crossed - approach obstacle at low speed and as much as possible at a right angle. Adjust speed without losing momentum and do not accelerate abruptly. Passenger must grasp both handholds firmly and brace feet on the floor. Hold steering firmly without closing your fists around it and proceed. Be aware that the obstacle may be slippery or may move while crossing.

### ***Hill Driving Conditions***

When driving on hills or slopes, two things are highly important: be prepared for slippery surfaces or terrain variations and obstacles and brace

yourself properly inside vehicle. If you climb or descend a hill that is too slippery or has too loose a surface, you can lose control. If you go over the top of a hill at high speed, you may not have time to prepare for the terrain on the other side. Avoid parking on a slope. Always put the shift lever in PARK when stopped or parked, especially on an incline, to avoid rolling. If you must park on a steep incline, block the wheels using rocks or bricks.

### Uphill Driving

Use the low range (L) for uphill driving.

Due to its configuration, this vehicle has very good traction even while climbing, so much so that tip over is possible before traction is lost. For example, it is common to encounter terrain situations where the top of the hill has eroded to a point that the hill peak rises very sharply. This vehicle is not designed to negotiate such a condition. Take an alternate route.

It is also wise to know the terrain condition on the other side of the hill or bank. All too often there exists a sharp drop-off that is impossible to negotiate or descend.

If you feel that the slope is getting too steep to climb, apply brakes to immobilize vehicle. Put shift lever in reverse (R), and back down the hill, barely releasing brakes to remain at low speed. Do not attempt to turn around. Never coast down hill while vehicle is in neutral. Do not perform hard braking as it increases the risk of tipover.

### Downhill Driving

This vehicle can climb steeper slopes than it can descend safely. Therefore, it is essential to assure that a safe route exists to descend a slope before you climb it.

Decelerating while negotiating a slippery downhill slope could “toboggan” the vehicle, causing it to slide. Maintain steady speed and/or accelerate slightly to regain control. Never slam brakes and lock the wheels.

### Side Hilling

Whenever possible, side hilling (driving across a slope rather than up or down it) should be avoided. If necessary, do so with extreme caution. Side hilling on steep inclines could result in rollover. In addition, slippery or unfirm surfaces could result in uncontrollable side sliding. Avoid all objects or depressions that will intensify the raising of one side of the vehicle higher than the other, thus causing rollover. If you feel the vehicle start to rollover or slide sideways, steer downhill if possible.

#### **WARNING**

**Be careful when loading and transporting liquid reservoirs. They can affect vehicle stability when side hilling by pulling downhill and increasing the risk of a roll over.**

### Drop-Offs

This vehicle is not designed to negotiate drop-offs. It will “bottom-out” and usually stop if either the front or rear wheels are driven over a drop-off. If the drop is sharp or deep, the vehicle will nose dive and tip over.

Avoid negotiating drop-offs. Reverse and select an alternate route.

### Recreational, Group and Distance Riding

Respect the rights and limitations of others. Stay away from areas designated for other types of off road use. This includes snowmobile trails, equestrian trails, cross country ski trails, mountain bike trails, etc. Never assume there are no other users on the trail. Always stay to the right of the



trail and do not zig zag to one side of the trail then the other. Be prepared to stop or pull off to the side if another trail user appears in front of you.

Join a local side-by-side vehicle club. It will provide you with a map and advice or inform you where you can ride. If a club does not exist in your area, help to start one. Group riding and club activities provide a pleasurable, social experience. Never use with drugs or alcohol, or tired or ill.

Always keep a safe distance from other riders. Your judgment of speed, terrain conditions, weather, mechanical condition of your vehicle and the "trust in judgment" you have in others around you will help you make a better choice of appropriate safe distance. This vehicle, like any other motorized vehicle, cannot stop "on a dime".

Before you ride, tell someone where you are planning to travel and your expected time of return.

Depending on the length of your ride, carry additional tools or emergency equipment. Find out where you can get additional gasoline. Be prepared for the possible conditions you may encounter. An emergency first aid kit should always be a consideration.

## Environment

One of the benefits of this vehicle is that it can take you off the beaten path away from most communities. However, you should always respect nature and the rights of others to enjoy it. Do not ride in environmentally sensitive areas. Do not drive over forest crops or shrubs, nor cut down trees or take down fencing, nor spin your wheels and destroy the terrain. "Tread Lightly".

This vehicle can cause OHV wildfires if debris builds up near the exhaust or other engine hot spots and ignites then falls off into dry grass. Avoid

riding in wet areas, through muskeg or tall grass, where debris can build up. Should you ride in those areas, inspect and remove all debris from your engine and hot spots. Refer to *Vehicle Care* for details.

Chasing wildlife is in many areas illegal. Wildlife can die of exhaustion after being chased by a motorized vehicle. If you encounter animals on the trail, stop and observe quietly and with caution. It will be one of the better memories of your life.

Observe the rule "what you take in, carry out". Do not litter. Do not start campfires unless you have permission to do so, and then only away from dry areas. The hazards you may create on the trail may cause injury to others or yourself, even at a later date.

Respect farm lands. Always obtain the permission of the landowner before riding on private land. Respect crops, farm animals and property lines.

Finally, do not pollute streams, lakes or rivers and do not modify the engine or exhaust system, or remove any of its components as it will alter the vehicle emissions.

# MOVING LOADS AND DOING WORK

## Working with Your Vehicle

Your vehicle can help you perform a number of different LIGHT tasks ranging from snow removal to carrying cargo. A variety of accessories are available from your authorized Can-Am dealer. To prevent possible injury, follow the instructions and warnings that accompany the accessory. Always respect the load limits of the vehicle. Overloading the vehicle can overstress the components and cause failure. Avoid overexerting yourself if you lift or pull heavy loads or manually push the vehicle.

Always be aware that the cargo may slide or fall off and cause an accident.

## Carrying Loads

Any load carried on the vehicle will affect the handling, stability and braking distance of the vehicle. Do not exceed the load limits of the vehicle, including the weight of operator, passenger, cargo, accessories and trailer tongue weight. Always be aware that the cargo may slide or fall off and cause an accident.

Load Limit of the Vehicle	
286 kg (630 lb)	Includes occupants, cargo, added accessories, and tongue weight (if applicable)

The following is an example of suitable total vehicle load distribution:

Example of Suitable Vehicle Total Loads (Low Range)				
OPERATOR AND PASSENGER	CARGO LOAD	ACCESSORIES	TONGUE WEIGHT	TOTAL VEHICLE LOAD
171 kg (377 lb)	31 kg (68 lb)	25 kg (55 lb)	59 kg (130 lb)	286 kg (630 lb)

### NOTE:

When the gearbox is in the high range, the combined weight on cargo rack and tongue weight must not exceed the cargo rack capacity, refer to *Technical Specifications*.

To reduce the risk to lose control or the load carried, follow these recommendations.

### Vehicle Settings When Carrying Load

When the total load exceeds 195 kg (430 lb), including weight of operator, passenger, cargo, accessories and, if

applicable, trailer tongue weight, inflate the tires to maximum pressure. Refer to *Technical Specifications*

### NOTE:

When carrying a passenger or heavy loads readjust suspension accordingly.

### NOTE:

When carrying heavy loads on the cargo rack or pulling a loaded trailer operate with the shift lever in L (low range).

## Loading the Cargo Rack

### NOTICE

**Do not exceed the maximum cargo rack capacity.**

For cargo rack capacity, refer to *Technical Specifications*.

Load cargo as low as possible – a higher load can raise the vehicle's center of gravity, which can reduce stability. Position cargo on the rack as evenly distributed as possible.

Secure the load on the cargo rack. Do not secure cargo to the cage or other part of the vehicle. If it is not properly secured, a load may slide or fall off, possibly striking occupants or bystanders; or it may shift during riding, affecting the handling of the vehicle.

Objects that are high may affect visibility for the driver and may act as projectiles in case of an accident. Loads that protrude sideways can get snagged or caught in bush, branches or other obstacles. Avoid covering and obstructing the brake lights with the cargo. Ensure no cargo protrudes outside the cargo rack and that cargo will not interfere with your visibility or control of the vehicle.

Do not overload cargo rack.

### ⚠ WARNING

**Never carry gasoline container(s) or any dangerous liquids on the cargo rack.**

### ⚠ WARNING

**Never overload, tow or carry cargo improperly. Safely reduce speed according to terrain conditions when carrying cargo or pulling a trailer, and avoid hills and rough terrain. Allow greater distance for braking. Always secure cargo as low as possible to reduce the effect of a higher center of gravity. Failure to follow the recommendations here could cause changes in vehicle handling which could lead to an accident.**

## Hauling a Load

### NOTICE

**A BRP approved rear hitch must be properly installed on the vehicle for hauling trailers.**

Never pull a load by attaching it to the cage or any other accessories; this can cause the vehicle to tip over. Use only the trailer hitch (if installed) or winch (if installed) to pull a load.

In an emergency situation, use the recovery hook to recover a stuck vehicle.

When pulling loads with a chain or cable, ensure that there is no slack before starting and maintain tension while pulling.

When pulling loads with a chain or cable, be sure to brake progressively. The inertia of the load could lead to an impact.

When hauling a load, respect the maximum hauling capacity. See *Pulling a Trailer* below.

### ⚠ WARNING

**A slack in the chain or cable can cause it to break and snap back.**

When pulling another vehicle, be sure that someone is controlling the pulled vehicle. They must brake and steer to prevent the vehicle from going out of control.

Before pulling loads with a winch, refer to the winch manufacturer's instructions.

Reduce your speed when hauling a load and turn gradually. Avoid hills and rough terrain. Never attempt steep hills. Allow more distance for braking, especially on inclined surfaces and when a passenger is on board. Be careful not to skid or slide.

### ***Pulling a Trailer***

#### **NOTICE**

**A BRP approved rear hitch must be properly installed on the vehicle for hauling trailers.**

Riding this vehicle with a trailer substantially increases the risk of toppling, especially on inclined slopes. If a trailer is used behind the vehicle make sure that its hitch is compatible with the one on the vehicle. Make sure the trailer is horizontal with the vehicle. (In some instances a special extension may have to be installed on the vehicle hitch). Use security chains or cables to secure the trailer with the vehicle.

Reduce your speed when pulling a trailer and turn gradually. Avoid hills and rough terrain. Never attempt steep hills. Allow more distance for braking, especially on inclined surfaces and when a passenger is on board. Be careful not to skid or slide.

Improperly loading a trailer may cause loss of control.

Always make sure load is evenly distributed and safely secured on the trailer; an evenly balanced trailer is easier to control.

Always put the shift lever to L (low range) for hauling a trailer – in addition to providing more torque, operating in low range helps account for the increased load on the rear tires.

When stopped or parked, block the vehicle and trailer wheels from possible movement.

Use caution when disconnecting a loaded trailer; it or its load may topple on you or others.

When hauling a trailer, respect the maximum tongue weight and towing capacity indicated on the label affixed to the hitch.

Make sure there is at least some weight on the tongue.

# IMPORTANT ON-PRODUCT LABELS (CANADA/ UNITED STATES)

## Hang Tag

### Canada/United States

This vehicle comes with a hang tag and labels containing important safety information.

Any person who rides this vehicle should read and understand this information before riding.

**WARNING**

**THIS VEHICLE IS INTENDED FOR RECREATIONAL USE AND SECONDARY GENERAL UTILITY APPLICATIONS  
NO OPERATOR UNDER AGE 16**

**TRAINING COURSES TO TEACH ROV DRIVING ARE AVAILABLE. FOR INFORMATION CONTACT YOUR DEALER.**

**Read the Operator's Guide and Safety Labels and Watch the Safety Video.**  
**Follow All Instructions and Warnings.**

**CHECK WITH YOUR DEALER TO FIND OUT ABOUT STATE OR LOCAL LAWS REGARDING ROV OPERATION.**

Improper Use of Off-Highway Vehicles Can Cause Severe Injury or Death

**Be Prepared**

- Fasten seat belts and make sure nets or doors are securely latched in place.
- Wear an approved helmet and protective gear.
- Each rider must be able to sit with back against seat, foot flat on the floor or on footrest, and hands on steering wheel or handholds. Stay completely inside the vehicle.

**Drive Responsibly**

Avoid loss of control and rollovers:

- Avoid abrupt maneuvers, sideways sliding, skidding or fishtailing, and never do donuts.
- Avoid hard acceleration when turning, even from a stop.
- Slow down before entering a turn.
- Plan for hills, rough terrain, ruts, and other changes in traction and terrain. Avoid paved surfaces.
- Avoid side hilling (riding across slopes).

Rollovers have caused severe injuries and death, even on flat, open areas.

**Be Sure Riders Pay Attention and Plan Ahead**  
If you think or feel the vehicle may tip or roll, reduce your risk of injury:

- Keep a firm grip on the steering wheel or handholds and brace yourself.
- Do not put any part of your body outside of the vehicle for any reason.

**Require Proper Use of Your Vehicle**

- Do your part to prevent injuries:
- Do not allow careless or reckless driving.
- Make sure operators are 16 or older with a valid driver's license.
- Do not let people drive or ride after using alcohol or drugs.
- Do not allow operation on public roads (unless designated for off-highway vehicle access) - collisions with cars and trucks can occur.
- Do not exceed seating capacity; see information on back side of this card

**THIS HANG TAG CAN'T BE REMOVED BEFORE SALE.**

**Tilt Table Test Result**

**Bombardier Recreational Products inc.**  
Vehicle Model: XXXX

**XX.X**

Measurement of lateral stability, in degrees, of a sample, standard condition vehicle (with an operator and a passenger load - 430 pounds) as measured by the manufacturer in accordance with the tilt table lateral stability test in the ANSI/ROHVA standard for Recreational Off-Highway Vehicles. Vehicle modification, accessories, and loading can affect lateral stability.

Training courses to teach ROV driving are available. For information contact your dealer and/or rohva.org.

Check with your dealer to find out about state or local laws regarding ROV operation.



THIS HANG TAG IS NOT TO BE REMOVED BEFORE SALE.

**VEHICLE ENGINE DESCRIPTION:**  
XXXXXX

**EPA CERTIFIED**

NER (NORMALIZED EMISSION RATE) = XX  
ON A 0 TO 10 SCALE, 0 BEING THE CLEANEST

Vehicle seating capacity:  Occupants

**⚠ WARNING.** Operating, servicing and maintaining an off-road vehicle can expose you to chemicals including engine exhaust, carbon monoxide, phthalates, and lead, which are known to the State of California to cause cancer and birth defects or other reproductive harm.

To minimize exposure, avoid breathing exhaust, do not idle the engine except as necessary, service your vehicle in a well-ventilated area and wear gloves or wash your hands frequently when servicing your vehicle.

For more information go to [www.P65Warnings.ca.gov/products/passenger-vehicle](http://www.P65Warnings.ca.gov/products/passenger-vehicle)



704906872

**⚠ WARNING**

GET FAMILIAR WITH THIS OFF-HIGHWAY VEHICLE (OHV); IT MAY EXCEED THE PERFORMANCE OF OTHER OHV YOU MAY HAVE RIDDEN.

THIS IS A HIGH PERFORMANCE OHV. INEXPERIENCED RIDERS MAY OVERLOOK RISKS AND BE SURPRISED BY THE SPECIFIC BEHAVIOR OF THIS OHV IN ANY TERRAIN CONDITION.



704906872

**THIS HANGTAG IS NOT TO BE REMOVED BEFORE SALE.**

## Safety Labels

Read and understand all the safety labels on your vehicle.

These labels are affixed to the vehicle for the safety of the operator, passenger or bystanders.

The following labels are on your vehicle, and they should be considered permanent parts of the vehicle. If missing or damaged, they can be replaced free of charge. See an authorized Can-Am dealer.

### NOTE:

In the event of any discrepancy between this guide and the vehicle, the safety labels on the vehicle have precedence over the labels in this guide.

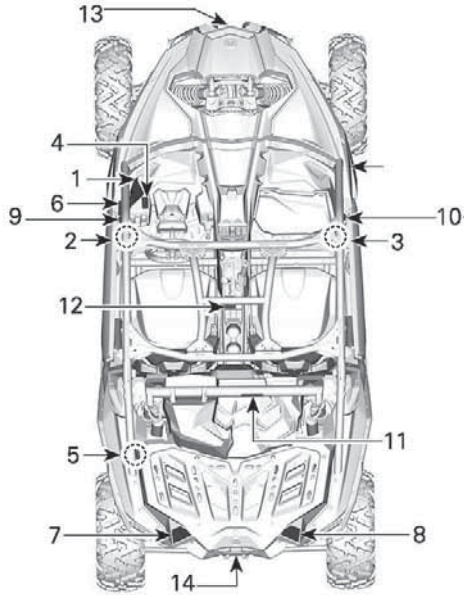

1. *General Safety Label*
2. *Operator Safety Label*
3. *Passenger Safety Label*
4. *Off-Road Vehicle Label*
5. *Tire Pressure Label*
6. *High Performance Vehicle Label*
7. *Vehicle Load Capacity Label*
8. *Cargo Warnings Label*
9. *LH Do Not Put Arms Outside Vehicle*
10. *RH Do Not Put Arms Outside Vehicle*
11. *Cage Warning Label*
12. *Shift Lever Warning Label*
13. *Recover Stuck Vehicle Only Label*
14. *Never Attach Here to Pull a Load Label*
15. *Winch Warnings - On Winch*

**WARNING**



**Improper Use of Off-Highway Vehicles Can Cause Severe Injury or Death**

**Be Sure Riders Pay Attention and Plan Ahead**

If you think or feel the vehicle may tip or roll, reduce your risk of injury:

- Keep a firm grip on the steering wheel or handholds and brace yourself.
- Do not put any part of your body outside of the vehicle for any reason.

**Be Prepared**

- Fasten seat belts and close doors.
- Wear an approved helmet and protective gear.
- Each rider must be able to sit with back against seat, foot flat on the floor or on footrest, and hands on steering wheel or handholds. Stay completely inside the vehicle.



Rollovers have caused severe injuries and death, even on flat, open areas.



**Drive Responsibly**  
Avoid loss of control and rollovers:

- Avoid abrupt maneuvers, sideways sliding, skidding or fishtailing, and never do donuts.
- Slow down before entering a turn.
- Avoid hard acceleration when turning, even from a stop.
- Plan for hills, rough terrain, ruts, and other changes in traction and terrain.

Avoid paved surfaces.

- Avoid side hilling (riding across slopes).

Patent : [www.brp.com/en/about-brp/patents.html](http://www.brp.com/en/about-brp/patents.html)



**GENERAL SAFETY LABEL**

**WARNING**



**Improper Use of Off-Highway Vehicles Can Cause Severe Injury or Death**

**DRIVER UNDER 16**

Be prepared in case of rollover

**NEVER** • Hold the cage while riding.  
• Try to stop a rollover using your arm or leg.

**ALWAYS** • Fasten seat belts and close doors.

Read and understand all safety labels, locate and read operator's guide. Watch the safety video using the QR code link or visit Can-am web site before operation.



**Require Proper Use of Your Vehicle**  
Do your part to prevent injuries:

- Do not allow careless or reckless driving.
- Make sure operators are 16 or older with a valid driver's license.
- Do not allow operation on public roads (unless designated for off-highway vehicle access) collisions with cars and trucks can occur.
- Do not let people drive or ride after using alcohol or drugs.
- Do not exceed seating capacity: 2 occupants.







**OPERATOR SAFETY LABEL**



**⚠ WARNING**

**PASSENGER**  
**Improper Use of Off-Highway Vehicles**  
**Can Cause Severe Injury or Death**  
**Be prepared in case of rollover**

**NEVER** • Hold the cage while riding.  
 • Try to stop a rollover using your arm or leg.

**ALWAYS** • Fasten seat belts and close doors.

**Be Prepared**



- Fasten seat belts and close doors.
- Wear an approved helmet and protective gear.
- Each rider must be able to sit with back against seat, foot flat on the floor or on footrest, and hands on handholds. Stay completely inside the vehicle.

**Be sure riders pay attention and plan ahead**  
 If you think or feel the vehicle may tip or roll, reduce your risk of injury:

- Keep a firm grip on handholds and brace yourself.
- Do not put any part of your body outside of the vehicle for any reason.

**Passenger qualifications and responsibilities**

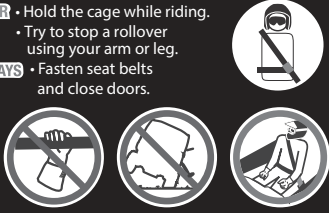
- Do not ride after using drugs or alcohol.
- Ask the operator to slow down or stop if you feel uncomfortable when riding

8155

PASSENGER SAFETY LABEL



**⚠ WARNING**

**Improper tire pressure or overloading**  
**can cause loss of control.**

**Loss of control can result in severe injury or death.**

- An under-inflated tire can come off the rim
- Use Max pressure if total load exceeds 195 kg (430 lb).

COLD TIRE PRESSURE	TIRE SIZE PACKAGE	30			32	
		DS / XDS / XRC	RS	XMR	XRS	XRC
Minimum	Front: kPa (psi)	138 ( 20 )	152 ( 22 )	117 ( 17 )	124 ( 18 )	138 ( 20 )
	Rear: kPa (psi)	179 ( 26 )	193 ( 28 )	165 ( 24 )	179 ( 26 )	179 ( 26 )
Maximum	Front: kPa (psi)	152 ( 22 )	165 ( 24 )	124 ( 18 )	138 ( 20 )	145 ( 21 )
	Rear: kPa (psi)	234 ( 34 )	262 ( 38 )	214 ( 31 )	221 ( 32 )	221 ( 32 )
MAX LOAD CAPACITY: kg (lb)		286 ( 630 )				

9147

TIRE PRESSURE LABEL

**⚠ WARNING**

This vehicle is an off road vehicle not intended for use on public roads.

704906373



**AVERTISSEMENT**

Ce véhicule est conçu pour un usage hors route et n'est pas destiné aux voies publiques.

OFF-ROAD VEHICLE LABEL

**⚠ WARNING**

Get familiar with this Off-Highway Vehicle (OHV); it may exceed the performance of other OHV you may have ridden.

This is a high performance OHV. Inexperienced riders may overlook risks and be surprised by the specific behavior of this OHV in any terrain condition.

704906439



HIGH PERFORMANCE VEHICLE LABEL

**! WARNING**

Overloading can cause loss of control. Loss of control can result in severe injury or death.

**NEVER** exceed REAR LOAD CAPACITY, evenly distributed, includes trailer tongue weight if applicable.

**NEVER** exceed the VEHICLE LOAD CAPACITY, including weight of operator, passenger (s), accessories and trailer tongue weight.

**NEVER** carry passenger on this carrier.

**ALWAYS** secure the load.



8976

REAR LOAD CAPACITY: kg (lb)	2 occupants 90 (200)	4 occupants 68 (150)
-----------------------------	-------------------------	-------------------------

VEHICLE LOAD CAPACITY LABEL

**! WARNING**

**NEVER** place gasoline, flammable or dangerous liquids container on carrier. This can lead to an explosion.

**NEVER** attach to cargo area to pull a load. this can cause the vehicle to tip over. use only the trailer hitch or recovery hook to pull a load.



8237

CARGO WARNING LABEL

**⚠ WARNING**

**Do NOT put your arm outside of the vehicle, there is a risk of SEVERE INJURY.**



**LH DO NOT PUT ARMS OUTSIDE VEHICLE**



**RH DO NOT PUT ARMS OUTSIDE VEHICLE**

**⚠ WARNING**

**NEVER attach to the cage to pull a load. This can cause the vehicle to tip over. Use only the trailer hitch or recovery hook to pull a load.**



6180A

**CAGE WARNING LABEL**

**⚠ WARNING**

**P**  
**R**  
**N**  
**H**  
**L**

Put the Shift Lever to PARK (P) before exiting vehicle. The vehicle can roll if not in PARK.

Stop the vehicle and apply the Brake before using the Shift Lever and the 2WD/4WD Switch.

Turning in 4WD - Lock (Front Diff Lock) requires more steering effort. Allow more room to turn.



704907122

SHIFT LEVER WARNING LABEL

**NOTICE**

USE ONLY TO RECOVER STUCK VEHICLE.  
NEVER USE TO PULL A LOAD



7410

RECOVER STUCK VEHICLE ONLY LABEL

**NOTICE**

NEVER attach here to pull a load



7408

NEVER ATTACH HERE TO PULL A LOAD LABEL

**⚠ WARNING**

- Locate and read operator's guide. Improper use can result in SEVERE INJURY or DEATH. Follow all instructions and warnings.
- Never put your fingers into the hook.
- Always use the hand strap to manipulate the hook and rope.
- Avoid putting your hand between hook and hawse or roller fairlead. You can crush your fingers.
- Never use the winch to lift objects or people.



WINCH WARNINGS - ON WINCH

## Compliance Labels

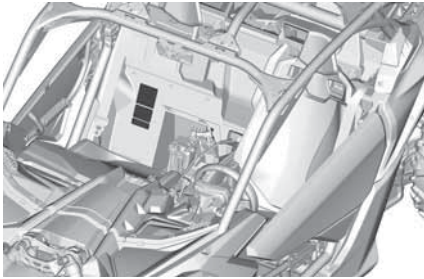

TYPICAL - EPA LABEL LOCATION

EMISSION CONTROL INFORMATION	
THIS VEHICLE IS CERTIFIED TO MEET THE FOLLOWING EMISSIONS REGULATIONS: FEDERAL AND CALIFORNIA: <input type="checkbox"/> U.S. EPA & CALIFORNIA EMISSIONS CONTROL REGULATIONS FOR HIGHWAY OFF-ROAD SPORT VEHICLE	
ENGINE MAKE	TABLE DE MOTEUR
PERMITS MAKE	TABLE DE PERMITS
PERMITS STATE	TABLE DE PERMITS
IDENTIFICATION STATE (FED)	TABLE DES EMISSIONS
IDENTIFICATION STATE (FED)	TABLE DES EMISSIONS
ENGINE DISPLACEMENT	CILINDRÉS
EXHAUST EMISSIONS CONTROL SYSTEM	SISTÈME DE CONTRÔLE DES ÉMISSIONS
<b>RENSEIGNEMENTS SUR LE DISPOSITIF ANTIPOLLUTION</b> CE VÉHICULE EST CERTIFIÉ POUR RÉPONDRE À LA NORME FÉDÉRALE ET CALIFORNIENNE EN MATIÈRE DE CONTRÔLE DE LA POLLUTION AU NIVEAU DES ÉMISSIONS MOTORISÉES POUR LES VTT ET LES VÉHICULES HORS ROUTE SPORTS.	
SEE OPERATOR'S GUIDE FOR MAINTENANCE SCHEDULE VOIR LE PROGRAMME D'ENTRETIEN DANS LE GUIDE DU CONDUCTEUR	
BOMBARDIER RECREATIONAL PRODUCTS INC.	

TYPICAL - EPA LABEL

BRP certifies that this ROV complies with the American National Standard for Recreational Off-Highway Vehicles, ANSI / ROHVA 1 - 2016 Standard.

BRP certifie que ce véhicule récréatif hors-route est conforme à la norme "American National Standard for Recreational Off-Highway Vehicles", ANSI / ROHVA 1 - 2016.

This roll over protective structure meets the performance requirements of ISO 3471: 2008 .

Cette structure de protection contre le retournement respecte les requis de performance de la norme ISO 3471: 2008 .



704906982

ON LH SIDE OF CAGE

## Technical Information Labels

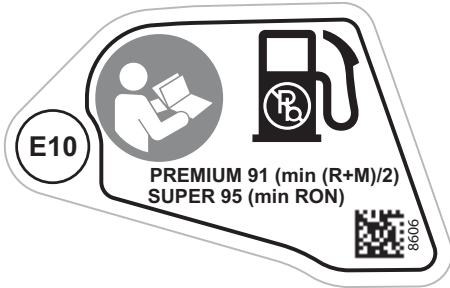
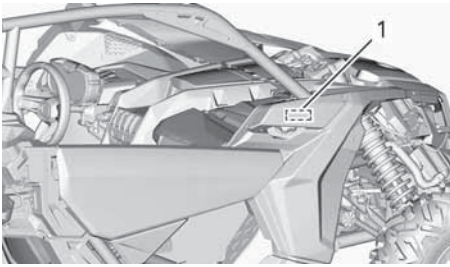

**INSIDE FUEL TANK CAP COVER**

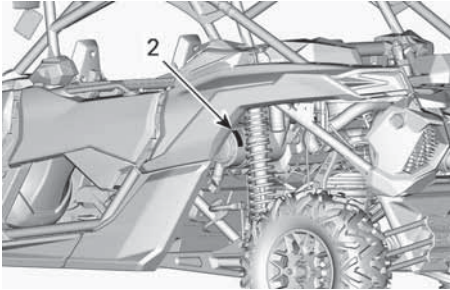

**AIR FILTER MAINTENANCE**  
 MAINTENANCE MUST BE PERFORMED AS SPECIFIED IN THE OPERATOR'S GUIDE. AIR FILTER MAINTENANCE SHOULD INCREASE IN FREQUENCY IN MORE SEVERE (DUSTY) CONDITIONS.

**ENTRETIEN DU FILTRE À AIR**  
 L'ENTRETIEN DOIT ÊTRE EFFECTUÉ TEL QUE SPÉCIFIÉ DANS LE GUIDE DU CONDUCTEUR. ENTRETIEN LE FILTRE À AIR PLUS SOUVENT DANS DES CONDITIONS PLUS EXTRÊMES (MILIEUX POUSSIÉREUX). 7078000373

**ON ENGINE AIR FILTER HOUSING**



**ON COOLANT BOTTLE CAP**

---

# IMPORTANT ON-PRODUCT LABELS (ALL COUNTRIES EXCEPT CANADA/UNITED STATES)

All Countries Except Canada/United States

## Vehicle Safety Labels

Read and understand all the safety labels on your vehicle. These labels are affixed to your vehicle for the safety of the operator or bystanders.

These labels are affixed to the vehicle for the safety of the operator or bystanders.

The safety labels on your vehicle should be considered permanent parts of the vehicle. If missing or damaged, they can be replaced free of charge. See an authorized Can-Am dealer.

### NOTE:

In the event of any discrepancy between this guide and the vehicle, the safety labels on the vehicle have precedence over the labels in this guide.



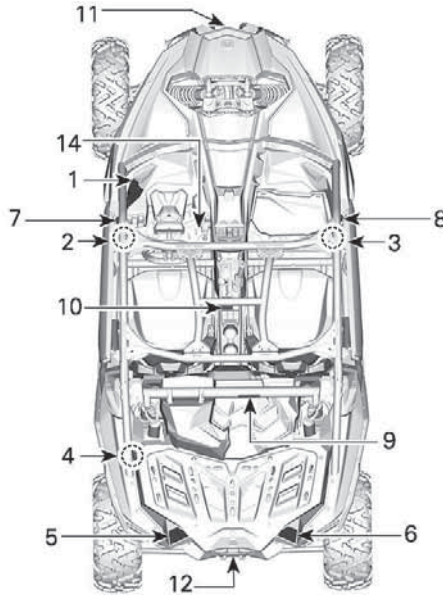

**TYPICAL**

- 1. General Safety Label
- 2. Operator Safety Label
- 3. Passenger Safety Label
- 4. Tire Pressure Label
- 5. Cargo Warnings Label
- 6. Vehicle Load Capacity Label
- 7. LH Do Not Put Arms Outside Vehicle
- 8. RH Do Not Put Arms Outside Vehicle
- 9. Cage Warning Label
- 10. Shift Lever Warning Label
- 11. Never Attach Here to Pull a Load Label
- 12. Recover Stuck Vehicle Only Label
- 13. Winch Warnings - On Winch
- 14. Eurasian Union Only Warning Label

## General Safety Label

### ⚠ WARNING

- Read and understand all safety labels, locate and read operator's guide. Watch the safety video using the QR code link or visit Can-am web site before operation.
- Avoid loss of control and rollovers: Avoid abrupt maneuvers, sideways sliding, skidding or fishtailing, and never do donuts. Avoid hard acceleration when turning, even from a stop. Slow down before entering a turn. Plan for hills, rough terrain, ruts, and other changes in traction and terrain. Avoid paved surfaces. Avoid side hilling (riding across slopes).
- Rollovers have caused severe injuries and death, even on flat, open areas
- Do not allow operation on public roads (unless designated for off-highway vehicle access) – collisions with cars and trucks can occur.
- Do not exceed seating capacity: 2 occupants.
- Make sure operators are 16 or older with a valid driver's license.

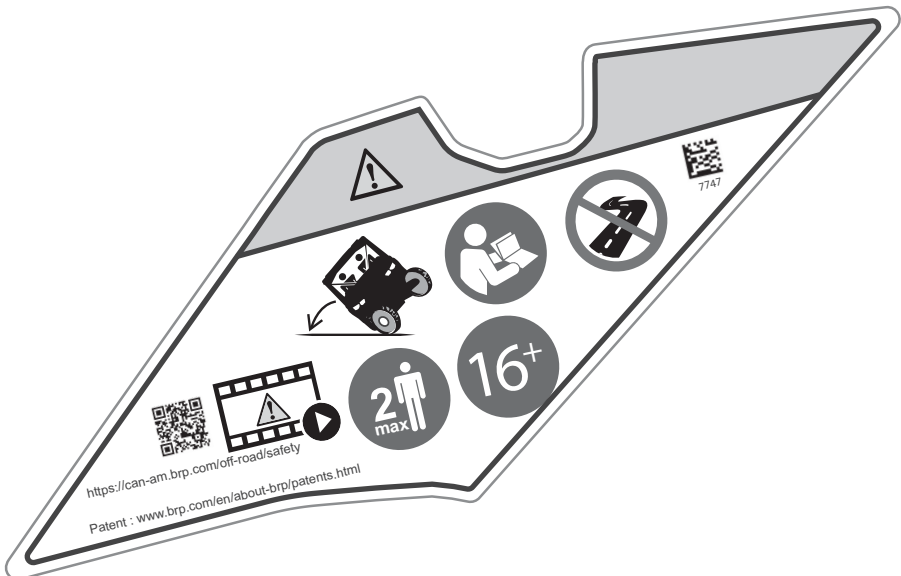

GENERAL SAFETY LABEL

## Operator and Passenger Safety Labels

### WARNING

- Always wear an approved helmet and protective gear.
- Always wear ear protection.
- Fasten seat belts and nets.
- Do not ride after using alcohol or drugs.
- If you think or feel the vehicle may tip or roll, reduce your risk of injury : Keep a firm grip on the steering wheel or handholds and brace yourself. Do not put any part of your body outside of the vehicle for any reason.
- Always stay completely inside the vehicle.
- Never hold the cage while riding.
- Each rider must be able to sit with back against seat, foot flat on the floor or on footrest, and hands on steering wheel or handholds.



OPERATOR SAFETY LABEL

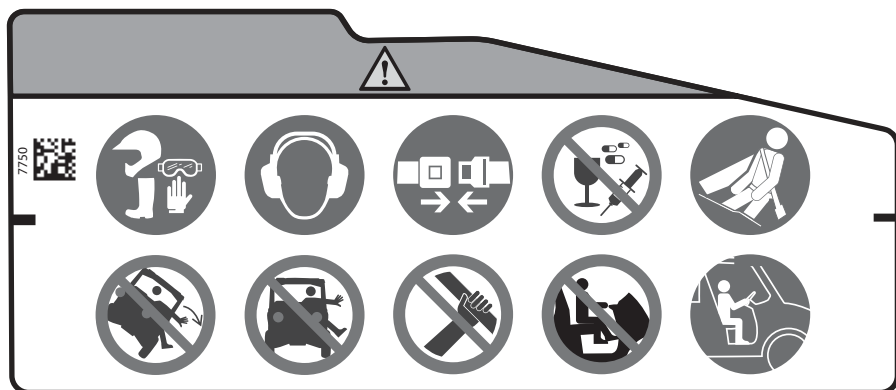

PASSENGER SAFETY LABEL

## Tire Pressure Label

### ⚠ WARNING

- Locate and read operator's guide. Improper tire pressure or overloading can cause loss of control, resulting in SEVERE INJURY or DEATH.
- Always maintain proper tire pressure as shown. Use Max pressure if total load exceeds 195 kg (430 lb).

9034

2x

		< 195 (430) kg (lb)				> 195 (430) kg (lb)	
		kPa (psi)		kg (lb)			
30	DS	193 ( 28 )	207 ( 30 )	234 ( 34 )	290 ( 42 )	286 ( 630 )	
32	XRS	124 ( 18 )	165 ( 24 )	138 ( 20 )	207 ( 30 )		
	XRC	138 ( 20 )	179 ( 26 )	145 ( 21 )	221 ( 32 )		

### TIRE PRESSURE LABEL

## Never Attach Here to Pull a Load Label

### NOTICE

Never attach here to pull a load.

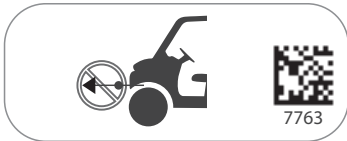

### NEVER ATTACH HERE TO PULL A LOAD LABEL

## Recover Stuck Vehicle Only Label

### NOTICE

Use only to recover stuck vehicle. Never use to pull a load. Trailer hitch installation required. Refer to operator's guide.

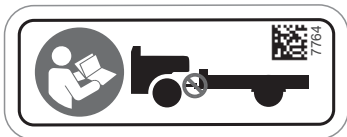

### RECOVER STUCK VEHICLE ONLY LABEL

## Cargo Warnings Label

**⚠ WARNING**

- Locate and read operator's guide.
- **NEVER** carry passenger in cargo box.
- **NEVER** place gasoline, flammable or dangerous liquids container on carrier. This can lead to an explosion.
- Reduce speed when carrying a load.
- **NEVER** attach to cargo area to pull a load.



**CARGO WARNINGS LABEL**

## Eurasian Union Only Warning Label

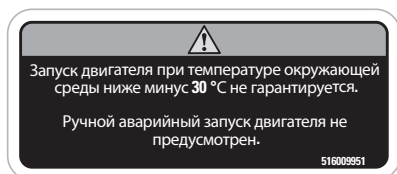

**EURASIAN UNION ONLY WARNING LABEL**

## Vehicle Load Capacity Label

### ⚠ WARNING

- Locate and read operator's guide. Improper tire pressure or overloading can cause loss of control, resulting in SEVERE INJURY or DEATH.
- NEVER exceed the vehicle load capacity, including weight of operator, passenger, cargo, accessories and trailer tongue weight if applicable.

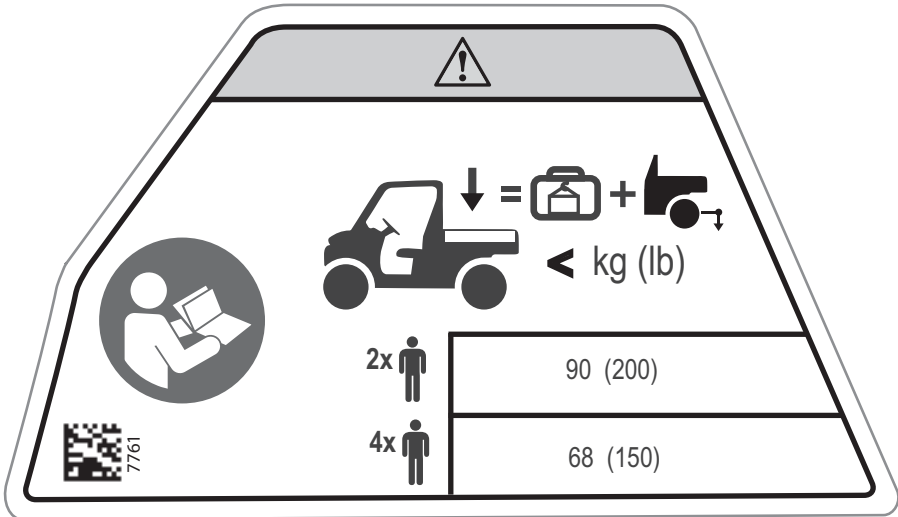

VEHICLE LOAD CAPACITY LABEL

## LH and RH Do Not Put Arms Outside Vehicle Labels

### WARNING

Do NOT put your arm outside of the vehicle, there is a risk of SEVERE INJURY.



## Cage Warning Label

### WARNING

NEVER attach to the cage to pull a load. This can cause the vehicle to tip over. Use only the trailer hitch or recovery hook to pull a load.

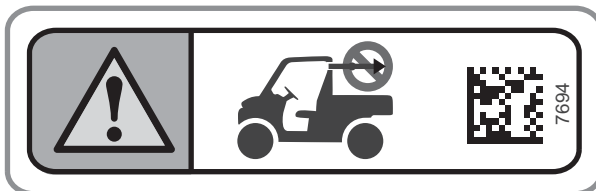

**CAGE WARNING LABEL**

## Shift Lever Warning Label

### ⚠ WARNING

- Stop the vehicle and apply the brake before using the shift lever and the 2WD/4WD switch.
- Put the shift lever to PARK (P) before exiting vehicle. The vehicle can roll if not in PARK.

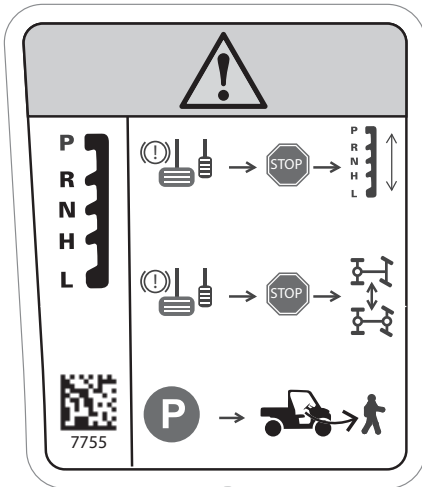

SHIFT LEVER WARNING LABEL

## Winch Warnings - On Winch

### ⚠ WARNING

- Locate and read operator's guide. Improper use can result in SEVERE INJURY or DEATH. Follow all instructions and warnings.
- Never put your fingers into the hook.
- Always use the hand strap to manipulate the hook and rope.
- Avoid putting your hand between hook and hawse or roller fairlead. You can crush your fingers.
- Never use the winch to lift objects or people.



WINCH WARNINGS - ON WINCH



## Technical Information Labels



LOCATED NEAR GAS CAP

### NOTICE

Refer to Operator's Guide for air filter maintenance schedule and instructions.



### NOTICE

Use unleaded fuel only. Recommended octane rating: PREMIUM 91 (min (R+M)/2) or SUPER 95 (min RON). Refer to operator's guide.

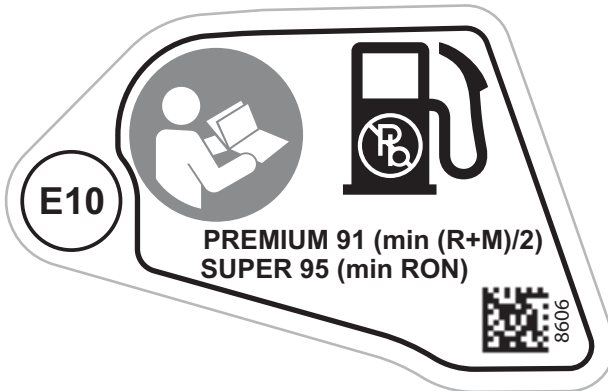

INSIDE FUEL TANK CAP COVER

---

## REPORTING SAFETY DEFECTS

In Canada, if you believe that your vehicle has a defect which could cause a crash or could cause injury or death, you should immediately inform Transport Canada in addition to notifying Bombardier Recreational Products Inc.

If Transport Canada receives similar complaints, it may open an investigation, and if it finds that a safety defect exists in a group of vehicles, it may order a recall and remedy campaign. However, Transport Canada cannot become involved in any individual problems between you, your dealer or Bombardier Recreational Products Inc.

### To Contact Transport Canada:



819-994-3328 (Gatineau-Ottawa area or internationally)  
Toll free : 1 800-333-0510 (in Canada)



Transport Canada - ASFAD  
330 Sparks Street  
Ottawa, ON  
K1A 0N5



<https://www.tc.gc.ca/recalls>

# VEHICLE INFORMATION

# PRIMARY CONTROLS

It is important to know the location and operation of all controls, and to develop and practice smooth and coordinated use of them.

## NOTE:

Some vehicle safety labels are not shown on illustrations. For information on vehicle safety labels, refer to *Important On-Product Labels*.

## Steering Wheel

The steering wheel is located in front of the driver's seat.

The steering wheel steers the vehicle to the left or right.

Turn the steering wheel in the direction you want to go.



1. Steering wheel

Grip the steering wheel with both hands, without having thumbs rolled around the steering wheel.

## CAUTION

**Under rough trail conditions or when crossing an obstacle, the steering wheel could suddenly jerk on one side, causing hand or wrist injuries if the thumbs are rolled around the steering wheel.**

## Models with DPS

The DPS (Dynamic Power Steering) reduces the effort to turn the steering wheel.

## Accelerator Pedal

The accelerator pedal is located on the right side of the brake pedal.

The accelerator pedal controls the engine speed.

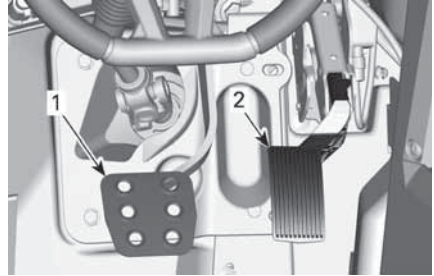

## TYPICAL

1. Brake pedal
2. Accelerator pedal

To increase or maintain vehicle speed, press on the accelerator pedal with your right foot.

To decrease vehicle speed, release the accelerator pedal.

The accelerator pedal is spring loaded and should return to rest position (idle) when not pressed.

## NOTE:

The accelerator pedal should never be disassembled.

## Brake Pedal

The brake pedal is located on the left side of the accelerator pedal.

The brake pedal function is to slow down or stop the vehicle.

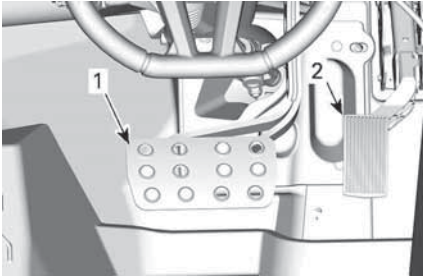
**XRC MODELS**

1. Brake pedal
2. Accelerator pedal

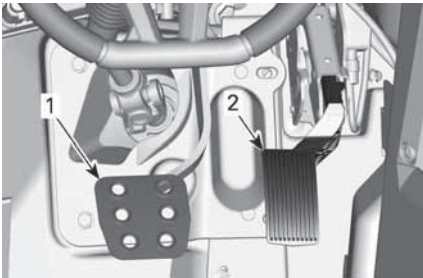
**ALL OTHER MODELS**

1. Brake pedal
2. Accelerator pedal

To decrease vehicle speed or to stop vehicle, press down the brake pedal with your right foot.

The brake pedal is spring loaded and should return to rest position when not pressed.

**Shift Lever**

The shift lever is located on the lower console, between the seats.

The shift lever is used to change the gearbox position.

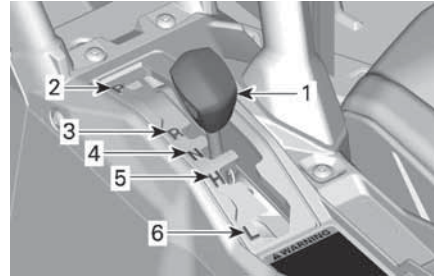

1. Shift lever
2. Park
3. Reverse
4. Neutral
5. High range (forward)
6. Low range (forward)

The vehicle must be stopped and brakes applied prior to selecting any gear.

**⚠ WARNING**

**This gearbox is not designed to shift while vehicle is moving.**

**Park**

The park position locks the gearbox to help prevent vehicle movement.

**⚠ WARNING**

**Always use the PARK (P) position when the vehicle is not in operation. The vehicle can roll if the shift lever is not set to P (PARK).**

**Reverse**

The reverse position allows the vehicle to go backwards.

Depending upon your particular vehicle configuration, a back-up alarm may be equipped on the vehicle. It goes on automatically when the reverse gear is selected.

**NOTE:**

In reverse operation, the engine RPM is limited thus limiting the vehicle reverse speed.

**⚠ WARNING**

**When driving downhill in reverse, gravity can increase the vehicle speed above safe reverse speed.**

***Neutral***

The neutral position disengages the gearbox.

***High Range (Forward)***

This position selects the high speed range of the gearbox. It is the normal driving speed range. It allows the vehicle to reach its maximum speed.

***Low Range (Forward)***

This position selects the low speed range of the gearbox. It allows the vehicle to move slowly with maximum torque at the wheels.

***NOTICE***

**Use the low speed range to pull a trailer, carry heavy cargo, go over obstacles or drive uphill and downhill.**

# SECONDARY CONTROLS

## NOTE:

Some vehicle safety labels are not shown on illustrations. For information on vehicle safety labels, refer to *Important On-Product Labels*.

## RF D.E.S.S Key and RF D.E.S.S. Post

### RF D.E.S.S. Post

The D.E.S.S. post is located on the upper console.

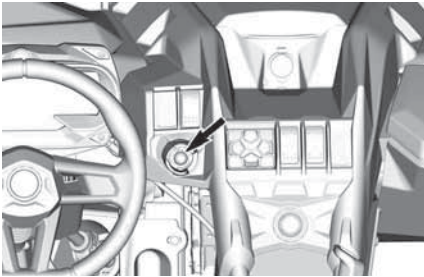

### RF D.E.S.S. Key

For all D.E.S.S. related option, see an authorized Can-Am dealer for information.

## Digitally Encoded Security System (D.E.S.S.)

This vehicle is delivered with 1 D.E.S.S. S. key.

The ignition keys contain an electronic circuit that gives it a unique electronic serial number.

The D.E.S.S. system reads the key code and allows engine starting for keys it recognizes.

This vehicle can be operated using different types of key programming:

- Performance
- Normal
- Work (if applicable)

Refer to your dealer for complete information.

## NOTE:

Additional keys are available from your dealer as an accessory.

## WARNING

Rollovers, tipovers, collisions and loss of control resulting in serious injury or death are possible with the performance or normal key. Using the normal key is not a substitute for the operator being prepared, qualified, and operating with care.

## Performance Key

The performance key allows the user to access the full torque of the engine as well as the top speed of the vehicle.

This may be useful for riders who prefer crisper throttle response, and for environments where higher speeds and greater acceleration are appropriate. For example, in wide-open straight trails, operators may prefer the performance key.

## Normal Key

The normal key limits the vehicle speed to 70 km/h (43 MPH) and 10% torque reduction.

## WARNING

On steep downhills, the engine speed limiter may not prevent the vehicle from accelerating beyond this speed.

This key may be useful for riders who prefer more gradual acceleration, or for riding in environments where full speed and high acceleration are not desirable. For example, in narrow, winding trails, operators may prefer a normal key.

## Work Key (if applicable)

The work key allows for usage of 100% of maximum engine torque but limits vehicle speed to 40 km/h (25 MPH).

### **D.E.S.S. Flexibility**

The D.E.S.S. of your vehicle can be programmed by your authorized Can-Am Off-road dealer to accept up to 8 different keys.

If you have more than one D.E.S.S. equipped your vehicle, each can be programmed by your authorized Can-Am Off-road dealer to accept the other vehicle D.E.S.S. keys.

### **Engine Start/Stop Button**

The engine start / stop button is located on the upper console. When pressed and held, it starts the engine. If the engine is running, when pressed, it stops the engine.

#### **NOTE:**

The RF D.E.S.S. key must be installed on the RF D.E.S.S. post to allow engine start.

To power up the electrical system without starting the engine, refer to *Waking Up the Electrical System*

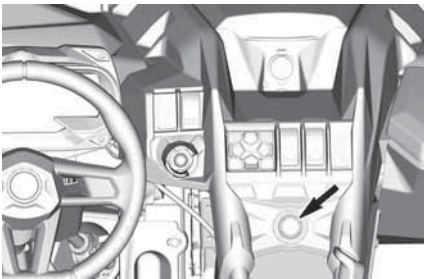

### **Headlight Dimmer Switch**

The headlight dimmer switch is located on the LH side of dashboard.

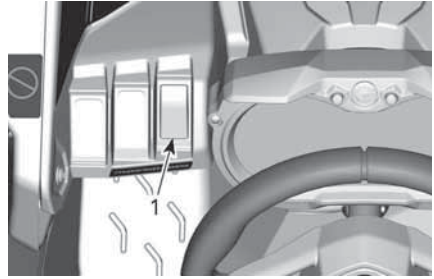

#### **TYPICAL**

1. Headlight dimmer switch

This switch is used to select either the headlights low or high beams.

### **Turbo RR models**

Hold the lower button to turn the headlights off. Simply push the same button to turn the headlights back on.

### **2WD/4WD/Front Diff Lock (if Equipped) Switch**

The 2WD/4WD/Front Diff Lock switch is located on the upper console.

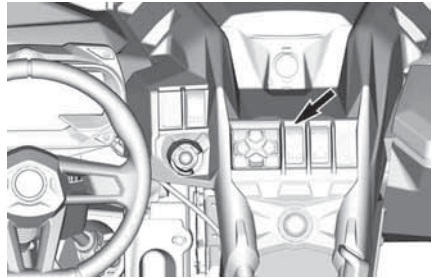

This switch selects 2 wheel drive or 4 wheel drive mode when the vehicle is stopped and the engine is running.

The front diff. lock can be activated on the fly, no need to stop the vehicle to engage. To deactivate, push again on the switch. When the vehicle is turned off, the front diff lock will be deactivated.



**NOTICE**

**Never go from 4X4 with the front diff locked to 2X4. Always unlock the front differential before putting the vehicle in 2X4 mode.**

**NOTICE**

**The vehicle must be stopped to engage or disengage 2WD/4WD switch. Mechanical damage may occur if switch is engaged or disengaged while driving.**

The front differential is fully locked when the switch is pushed upward. It's a momentary position. When the front diff is locked, the switch light will illuminate and a message will appear in the cluster for 2 seconds to say "DIFF LOCK". The light will turn off when the differential is unlocked and a message in the cluster will appear and show "SMART-LOK", meaning that you are back in the automatic mode.

When the front differential is locked, the effort to turn the steering wheel might be higher and the response might be slower.

**⚠ WARNING**

**Abruptly changing direction can cause loss of control or injury. Never engage Front Diff Lock before entering a turn or when turning.**

The 4WD mode is engaged when the switch is in the middle position.

The 2WD mode is engaged when the switch is pushed downwards. The vehicle is then rear wheel drive only.

## Riding Mode Switch

### On Some Models Only

This switch is used to choose between the TRAIL or TRAIL ACTIV mode.

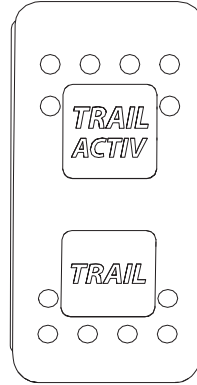
**TRAIL**

This mode must be used during all normal riding.

The front differential will automatically synchronize the front wheels as needed.

**TRAIL ACTIV**

This mode is used to increase traction on the front drive train.

This will optimize traction while going out of a corner and/or while doing hard acceleration by the detection of the engine torque required by the driver.

When using this mode, you need to adjust of your driving style as the front drivetrain is going to pull more than usually.

**⚠ WARNING**

**The fully locked option of the front differential reduces the maneuverability of the vehicle in certain conditions.**

**Keypad**

The keypad is located on the upper console.

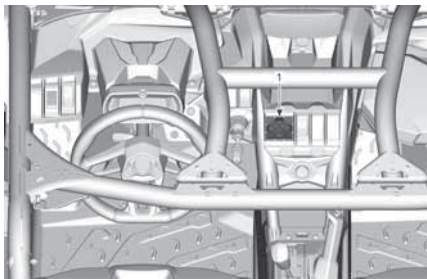

1. Keypad

The keypad is used to navigate through various menus and options. Refer to 7.6" Digital Display.

## Override Switch

The override switch is located on the lower console.

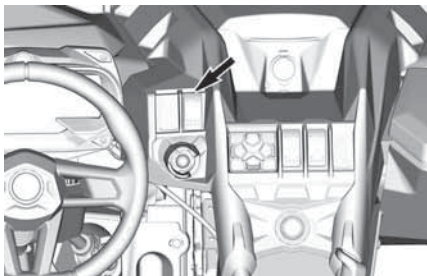

The override switch is used to:

- Bypass the engine speed limiter in reverse by allowing maximum engine torque. Refer to *Entering the Override Mode*.
- Temporarily deactivate the electronic drive belt protection (if available and activated on your model).
- Erase the MAINTENANCE REQUIRED message, refer to 4.5" Digital Display or to 7.6" Digital Display (Keypad).
- Allow the vehicle to be driven in the eventuality of an accelerator pedal failure. Refer to *Entering the Manual Limp Home Mode*.

## Entering the Override Mode

Press and hold the override switch to enter the bypass mode.

### WARNING

Use the "override" mode only if the vehicle is caught in mud or other soft terrain and the "low range" is not enough. Make sure the area is secure before using the "override" mode. Do not use the "override" mode when driving normally in reverse, this would result in excessive speed.

Release the override switch to exit the bypass mode.

## Entering the Manual Limp Home Mode

If one or both the pedal position sensor(s) is (are) defective, the accelerator pedal will not respond.

Depending on the type of failure, pressing and holding the Override Switch, will temporarily restore the response of the pedal OR temporarily increase the engine speed to be able to drive the vehicle.

Releasing the Override Switch will release the throttle and let the engine return to idle speed.

## Winch Switch (if Equipped)

The winch can be controlled from inside and outside the vehicle with the winch control switch located in the upper console.

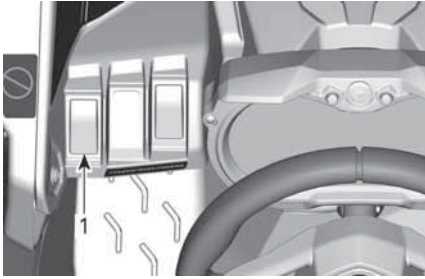

1. Winch switch

Refer to your winch *Guide* included with your vehicle for proper winch operation.

## Horn Switch (On Applicable Models)

To activate the horn, push on the switch.

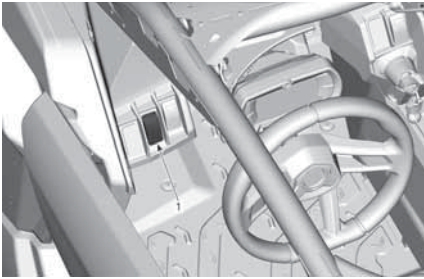

1. Horn switch

## Smart-Shox Suspension Mode Switch (On Applicable Models)

The Smart-Shox suspension mode switch is located on the upper console.

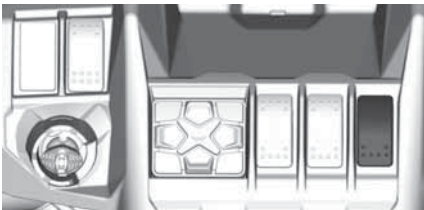

There is 3 suspension modes: Sport, Sport +, and Comfort.

Refer to *Tune Your Ride* for more information.

# 4.5" DIGITAL DISPLAY

## Multifunction Display

### General View

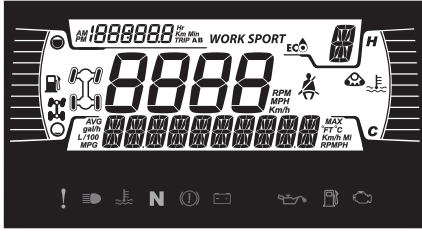

### Lower Display

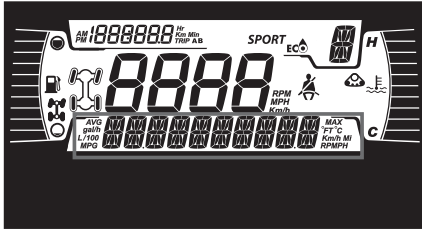

May display the following:

- RPM
- Speed statistics
- Engine Temperature
- Battery Voltage
- Settings
- Messages

Use LOWER button to change the displayed information.

### Left Lateral Display

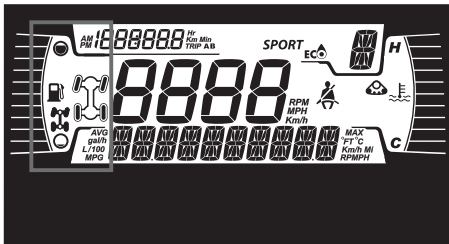

The left lateral display includes:

- Fuel level indicator
- 2X4 / 4X4 telltale
- Rear diff lock

Icon	Country
	For European community countries
	For all other countries

### Right Lateral Display

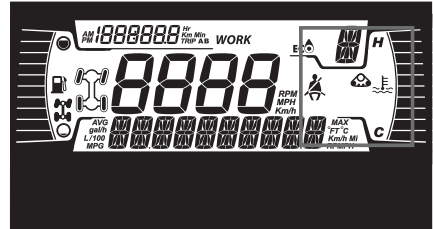

The right lateral display includes:

- Engine Temperature
- Track Kit Telltale
- Seat belt reminder

When a track kit is installed, a message will scroll in the lower display.

### Central Display

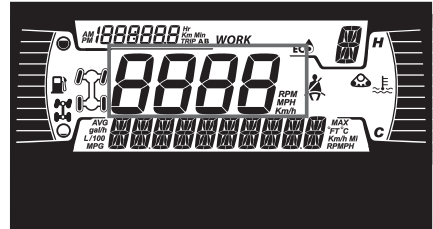

Display the vehicle speed in km/h or MPH.

## Transmission Position Display

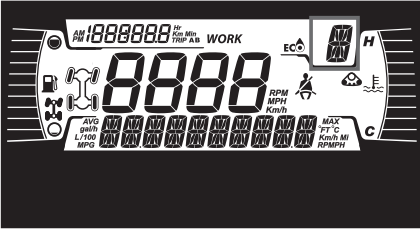

This display shows gear position of gearbox:

- P (Park)
- R (Reverse)
- N (Neutral)
- H (High Range)
- L (Low Range)
- - (Invalid Range)

## MODE Display

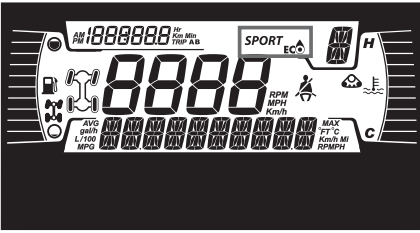

The MODE display indicates the selected mode of operation:

- ECO
- SPORT

The Sport mode provides a crisper throttle response.

**NOTE:** The sport mode can be activated with all key types and provides the maximum performance with the key in use.

The ECO (fuel economy mode) setting reduces fuel consumption by limiting throttle response and maximum

throttle opening to maintain an optimal cruising setting.

**NOTE:** Use ECO mode on bumpy trails to provide smoother ride conditions.

To change between modes, hold LOWER button and short press LOWER button to cycle through available modes.

Drive Mode	Message at Activation
Sport	SPORT MODE
ECO	ECO MODE

## Trip Display

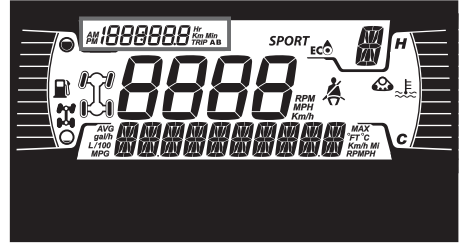

This display shows trip information:

- Cumulative distance odometer
- Trip A
- Trip B
- Vehicle hour meter
- Clock

Use UPPER button to change the displayed information.

Hold UPPER button to reset Trip A/B meters.

## Warning Lamps and Indicators

The following indicator lamps will alert you to a vehicle condition that may become serious. Some lamps will illuminate when starting the vehicle to make sure they work. If any lamps remain on after starting the vehicle, refer

to the respective system warning lamp for further information.

**NOTE:**

Some warning indicators appear in the display of the multifunction gauge and function the same as an indicator lamp but do not display when starting the vehicle.

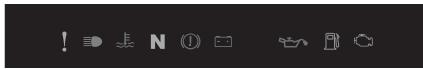
**Telltale Lights - Lower Bar**

Warning and Telltale Lights	
	ORANGE - Vehicle Malfunction
	BLUE - High Beam
	RED - The engine temperature is too high.
	GREEN - Neutral
	RED - (Blinking) Accelerator pedal and the brake are activated simultaneously for a certain time (a torque limitation is active)
	RED - Low battery.
	RED - Low oil pressure (Normally ON at engine OFF)
	ORANGE - Low fuel level
	ORANGE - Check engine

**Icons and Indicators - Multifunction Display**

Icons and Indicators	
<i>SPORT</i>	Denotes SPORT mode is selected.
	Denotes ECO mode is selected.
	When lit, seat belt not buckled with vehicle immobilized. Flashing when vehicle is moving.
	Track kit active (If Equipped)

**Settings**

The buttons to navigate through menus are located on the left side of the LCD display.

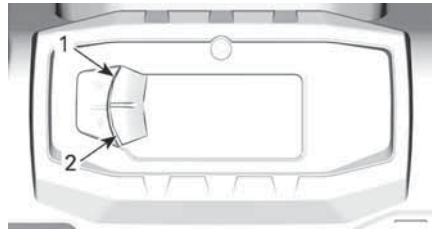
**TYPICAL**

1. Upper button
2. Lower button

**Setup**

Using LOWER button, select **SETTINGS** and hold to enter setting menu.

**Maintenance Reset****NOTE:**

Only when the maintenance icon is displayed.

Using LOWER button, select **RES MAINT** and hold to reset maintenance.

### **Fault Codes**

Available only when at least one code is activated.

Using LOWER button, select **CODES** and hold to see active fault codes.

Fault codes will be scrolled on the Lower Display.

### **Reset Stats**

Using LOWER button, select **RESET STAT** and hold to reset.

### **Unit Selection**

This multifunction gauge is factory preset in Imperial units but it is possible to change it to Metric units.

Using LOWER button, select **UNITS** and hold button to change units.

### **Setting Clock**

All of the following action must be performed using the LOWER button.

1. Select **CLOCK** and hold to adjust clock.
2. Press the button to select clock display.
3. Push and hold the button for 1 second.
4. Press the button to select 12:00 AM PM or 24:00 time base.
5. Push and hold the button to acknowledge selection.
6. Press the button to change hours (hours flash).
7. Push and hold the button to acknowledge hour selection.
8. Press the button to switch to minutes (minutes flash).
9. Push and hold the button to acknowledge minutes selection.

### **Setting Language**

The gauge display language can be changed.

Refer to an authorized Can-Am Off-road dealer for language availability and to setup the gauge to your preference.

### **Setting Brightness**

The brightness of the LCD display can be adjusted.

Using LOWER button, select **BRIGHTNESS** and hold button to change brightness.

Using LOWER button, adjust brightness then push and hold the button to acknowledge selection.

# 7.6" DIGITAL DISPLAY (KEYPAD)

## Basic Functions

### Multifunction Gauge Description

**⚠ WARNING**

**Do not adjust the display while riding, you could lose control.**

### General View

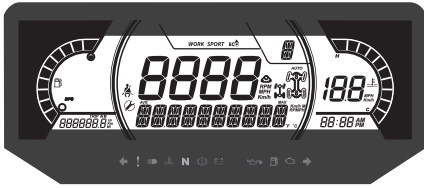

### Lower Display



### May display the following:

- RPM
- Speed statistics
- Engine Temperature
- Battery Voltage
- Settings
- Messages
- Active DPS mode (Maverick models only)
- CVT Belt Temperature (On applicable models)

The SPEED STAT display shows the maximum and the average speed. Hold MENU or OK button for 1 second to reset.

### Left Lateral Display



The left lateral display includes:

- Fuel level indicator
- Tripmeter (A - B)
- Odometer
- Vehicle Hour meter
- DPS indicator

### Right Lateral Display

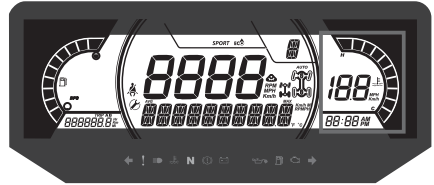

The right lateral display includes:

- Engine Temperature
- Clock
- Speed indicator

The speed indicator in this display is activated when the central display shows information other than the speed. Otherwise it is blank.

### Central Display

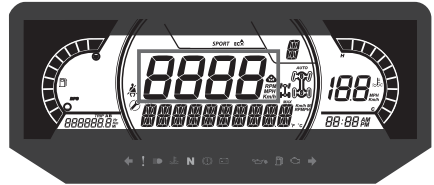

May display the following:

- RPM
- Vehicle speed

### Transmission Position Display



This display shows gears position of gearbox:

- P (Park)



- R (Reverse)
- N (Neutral)
- H (High range)
- L (Low range)
- - (Invalid gear)

### Smart-Shox Suspension Icon (if Equipped)



This icon appears and blinks when entering suspension mode selection or when suspension fault occurs.

Refer to *Tune Your Ride* section for adjustment procedure.

### MODE Display

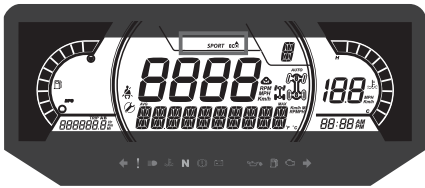

The MODE display indicates the selected mode of operation:

- SPORT
- ECO

The Sport mode provides a crisper throttle response.

### NOTE:

The sport mode can be activated with all key types and provides the maximum performance with the key in use.

The ECO (fuel economy mode) setting reduces fuel consumption by limiting throttle response and maximum throttle opening to maintain an optimal cruising setting.

### NOTE:

Use ECO mode on bumpy trails to provide smoother ride conditions.

To change between modes, press DRIVE MODE button on keypad to cycle through available modes.

A message of the selected mode will be displayed on the lower display at activation and deactivation as follow:

Drive Mode	Message at Activation
Sport	SPORT MODE
ECO	ECO MODE

### Middle Right Display



The middle right display indicates the selected mode of operation:

- 2X4
- 4X4
- Active tracks

Icon	Country
	For European community countries
	For all other countries

### Middle Left Display

The middle left lateral display includes:







- Seat belt reminder
- Maintenance reminder

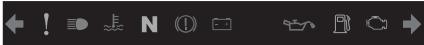



### Indicator Lamps





#### Warning and Telltale Lights



Warning and Telltale Lights	
	RED - The engine temperature is too high.
	RED - Low battery. (Normally ON at key ON engine OFF)
	RED - Low oil pressure
	ORANGE - Low fuel level
	ORANGE - Check engine
	ORANGE - Vehicle Malfunction
	RED - (Blinking) Accelerator pedal and the brake are activated simultaneously for a certain time (a torque limitation is active)

Warning and Telltale Lights	
	BLUE - High Beam
	GREEN - Neutral

### Icons and Indicators

Icons and Indicators	
	Denotes SPORT mode is selected.
	Denotes ECO mode is selected.
	When lit, seat belt not buckled with vehicle immobilized. Flashing when vehicle is moving.
	When lit, indicates that a maintenance is required. See your authorized Can-Am dealer or person of your own choosing for the maintenance.
	Track kit active (If Equipped)

### Settings

#### Setup

Using MENU button on the keypad, select **SETTINGS** and hold to enter setting menu.

OK button can be pressed instead of holding MENU button.

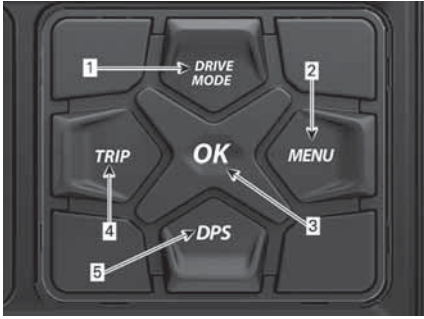

### 5 BUTTONS KEYPAD

1. DRIVE MODE button
2. MENU button
3. OK button
4. TRIP button
5. DPS button

### Maintenance Reset

#### NOTE:

Only when the maintenance icon is displayed.

Using MENU button, select **RES MAINT** and hold to reset maintenance.

### Fault Codes

Available only when at least one code is activated.

Using MENU button, select **CODES** and hold to see active fault codes.

Fault codes will be scrolled on the Lower Display.

### Reset Stats

Using MENU button, select **RESET STAT** and hold to reset.

### Unit Selection

This multifunction gauge is factory preset in Imperial units but it is possible to change it to Metric units.

Using MENU button, select **UNITS** and hold button to change units.

### Speed/RPM

The speed and RPM display can be swapped.

Using MENU button, select **SPEED/RPM** and hold button to invert speed and RPM display.

### Setting Clock

All of the following action must be performed using the MENU button.

1. Select **CLOCK** and hold to change time.
2. Press the button to select clock display.
3. Push and hold the button for 1 second.
4. Press the button to select 12:00 AM PM or 24:00 time base.
5. Push and hold the button or OK button to acknowledge selection.
6. Press the button to change hours (hours flash).
7. Push and hold the button or OK button to acknowledge hour selection
8. Push the button to switch to minutes (minutes flash).
9. Push and hold the button to acknowledge minutes selection.

### Setting Brightness

The brightness of the LCD display can be adjusted.

Using MENU button, select **BRIGHTNESS** and hold MENU button to select the brightness setting.

Using MENU button, adjust brightness then push and hold MENU button to acknowledge selection.

### Setting Language

The gauge display language can be changed.

Refer to an authorized Can-Am Off-road dealer for language availability and to setup the gauge to your preference.

### ***DPS Modes***

The lower display can show which DPS mode is active. Refer to *Tune Your ride*.

# EQUIPMENT

**NOTE:**  
Some vehicle safety labels are not shown on illustrations. For information

on vehicle safety labels, refer to *Important On-Product Labels*.

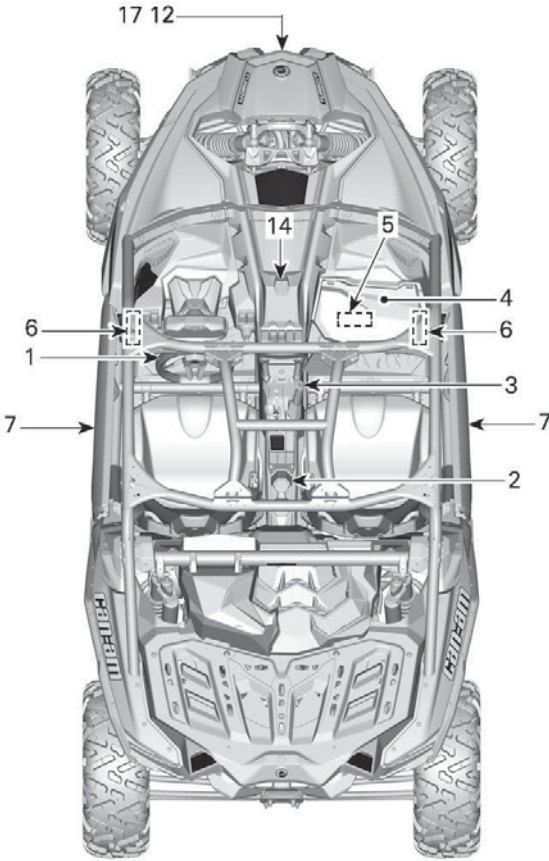

*TYPICAL*

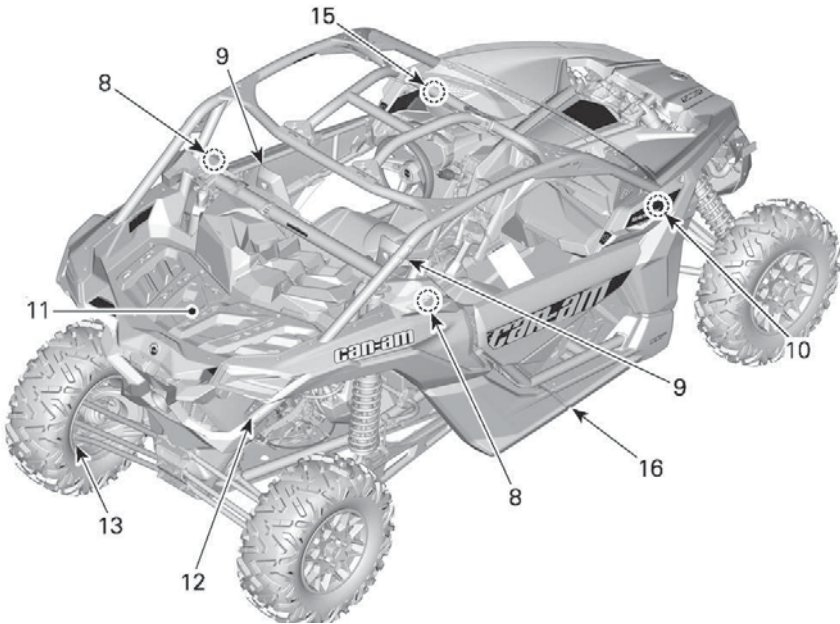
**TYPICAL**

1. Tilt Steering
2. Cup Holder
3. passenger Handholds
4. Glove Box
5. Tool Kit
6. Foot Rest
7. Doors
8. Seat Belts
9. Seats
10. Fuel Reservoir Cap
11. Cargo Rack
12. Recovery Hook
13. Wheel Scraper
14. 12 Volt Power Outlet
15. Central Rearview Mirror
16. Rock Sliders and Suspension Arm Protectors
17. Winch

**Tilt Steering**

The steering wheel height is adjustable.

Adjust the steering wheel height to face your chest, not your head.

To adjust steering wheel height:

1. Unlock steering by pulling the tilt lever toward you.
2. Move steering wheel to the desired position.
3. Release tilt lever to lock steering wheel in position.

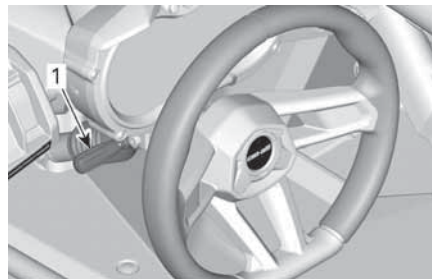

1. Tilt lever

**⚠ WARNING**

**Never adjust the steering wheel height while riding. You may lose control.**

## Cup Holders

Two cup holders are located at the rear of the lower console.

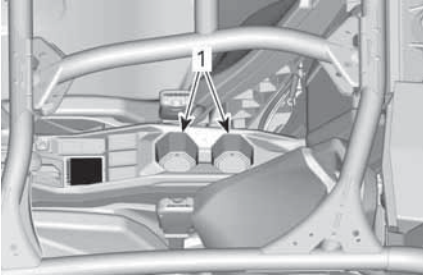

**TYPICAL**

1. Cup holders

### NOTE:

Do not use cup holders while riding in rough conditions.

## Passenger Handholds

There is one passenger handhold on the console and one in the RH door.

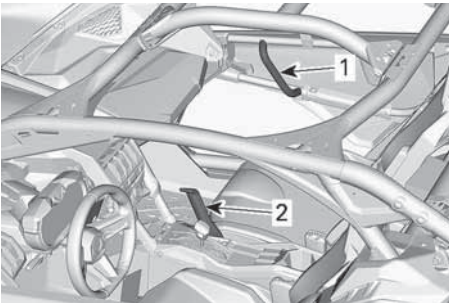

1. Door handhold  
2. Console handhold

Adjust the seat position in order to get a solid and comfortable grip on the handholds. Refer to *Seats* for adjustment procedure.

Holding the handholds helps the passenger brace against the movement of the vehicle and helps keep hands and body inside the cockpit in the event of a rollover.

## ⚠ WARNING

**Never use any part of vehicle cage as handholds. Hands can be struck by objects outside the cockpit or crushed in a rollover.**

## Glove Box

The vehicle is equipped with a closed glove box intended to carry light objects.

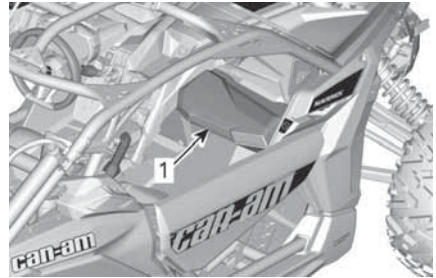

1. Glove box

### Glove Box Capacity

MAXIMUM  
LOAD

5 kg (11 lb)

## Tool Kit

A tool kit with basic tools is provided. It is located in the glove box.



1. Tool kit

## Footrests

The vehicle is equipped with driver and passenger footrests to allow

firmly planting feet on vehicle floor, which helps to maintain proper body position while riding.

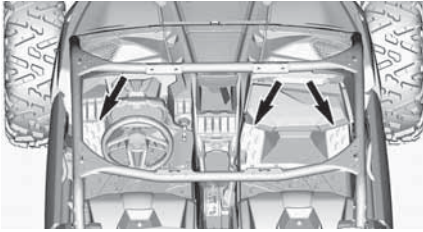

The footrests help minimize the risk of leg or foot injury.

Always wear appropriate footwear. See *Riding Gear*.

## Doors

The vehicle is equipped with doors to help occupants keep their body and limbs inside the vehicle, reducing the risk of injury.

The doors can also prevent the intrusion of branches and other foreign objects into the passenger compartment.

### **⚠ WARNING**

**Never operate vehicle unless both doors are closed and secured.**



1. Door closed and locked in place

To unlock doors, pull on the strap to release the latch.

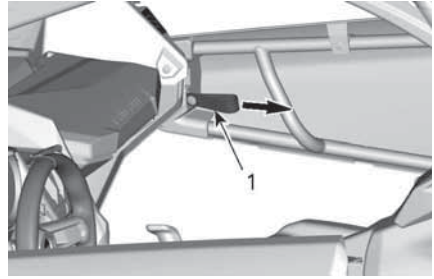

1. Latch strap

## Seat Belts

This vehicle is equipped with 3-point seat belts to help protect driver and passengers in the event of a collision, rollover, or tipover. The seat belts can help keep occupants stay in the passenger compartment.

### **⚠ WARNING**

**Wear seat belts properly at all times. Seat belts reduce the risk of injury in a crash and help keep limbs inside the cockpit in a rollover or any accidents.**

If driver's seat belt is not fastened when:

- The ignition is turn ON, the seat belt indicator lamp will flash.
- The engine is started and shift lever is moved out of PARK, vehicle speed will be limited to a maximum of approximately 20 km/h (12 MPH) on flat ground.

### **⚠ WARNING**

**The vehicle may reach higher or lower speed depending on inclines.**

To remind you to fasten the seat belt, the multifunction gauge will display the following message: ENGINE LIMITATION ENGAGED FASTEN SEAT BELT.



**⚠ WARNING**

There is no indicator light or message for the passengers seat belts. The driver is responsible for the passengers safety and should ensure the passengers buckles their seat belts.

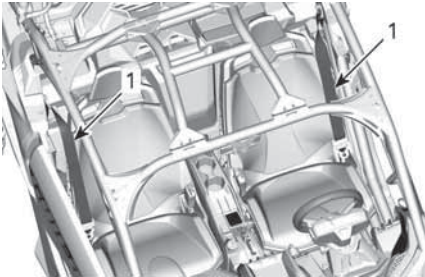
**3-Point Seat Belts**

**TYPICAL**

1. Seat belt

**⚠ WARNING**

Wear seat belt properly. Make sure it remains securely fastened and tightened against the body. Make sure it is not twisted or defective.

The seat belt is equipped with a semi-cinching tab.

This device locks the seat belt in the adjusted position.



**TYPICAL - LOCKED POSITION**

1. Semi-cinching tab

To fasten the seat belt, insert the latch plate into the buckle, then pull the belt to ensure it is properly fastened.

Adjust the seat belt tightly against your body by pulling the shoulder belt upwards.



**TYPICAL**

To detach the seat belt, push on the red button on the buckle.

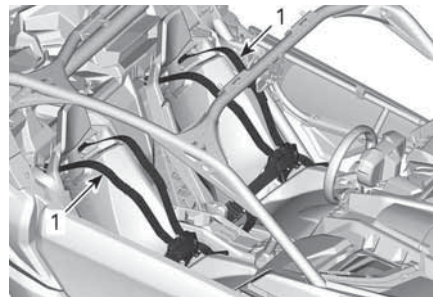
**4-Point Seat Belts**

**TYPICAL - PARTS REMOVED FOR CLARITY**

1. Seat belt

**⚠ WARNING**

Wear seat belt properly. Make sure it remains securely fastened and tightened against the body. Make sure it is not twisted or defective.

To fasten the seat belt, insert the latch plate into the buckle, then pull the belt to ensure it is properly fastened.



**On both sides**, adjust the seat belt tightly against your body by pulling the excess of the lap belt towards the inside. The buckle must be centered at the waistline (as low as possible).



To loosen the seat belt, hold the lap belt with one hand and pull the red strap outwards.



To detach the seat belt, push on the red button on the buckle.

## Seats

### *Seat Forward and Rearward Adjustment*

The seats can be adjusted forward or backward.

Slide the adjustment lever, place the seat at the desired position, then release the lever.

Try to move the seat forward and backward to make sure it is properly locked in place.



1. Adjustment lever

### **⚠ WARNING**

**Never adjust the seat position while the vehicle is moving.**

### *Seat Cushion Removal and Installation*

Unclip the cushion retaining tab.



Pull up the rear of the cushion, then free the cushion from the seat frame by pulling it off towards the rear.

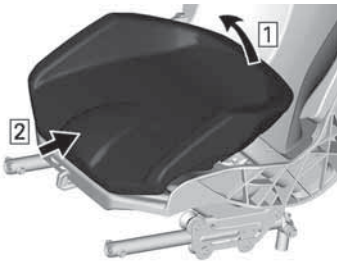

To install, reverse the removal procedure.

### **Seat Removal and Installation**

Remove the seat cushion.

Remove all four anchor points.

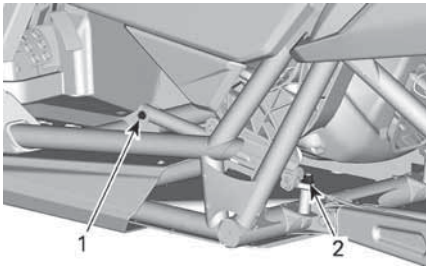

#### **PARTS REMOVED FOR CLARITY**

1. Front anchor point
2. Rear anchor point

To install, reverse the removal installation, however pay attention to the following.

Install seat using **NEW** nuts. Tighten to specification.

### **⚠ WARNING**

**Use new nuts when installing seat anchor points.**

### **Tightening Torque**

Rear anchor point	105 ± 15 Nm (77 ± 11 lbf-ft)
Front anchor point	24.5 ± 3.5 Nm (18 ± 3 lbf-ft)

### **Seat Height Adjustment**

Seat height can be adjusted using the anchor points. See *Seat Removal and Installation*.

### **Setup in HIGH Position**

Remove the seat cushion.

Remove both nuts securing the rear anchor points.

Remove both nuts securing the front anchor points.

Assemble both rear anchor points as shown. Use **NEW** nuts.



#### **REAR ANCHOR POINT IN HIGH POSITION**

1. Retaining nut
2. Seat frame
3. Sleeve
4. Vehicle frame

Install both front anchor points as shown. Use **NEW** nuts.

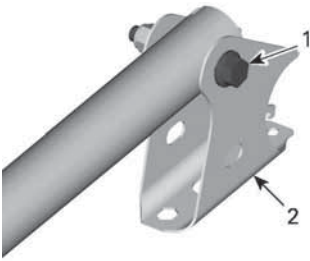

### FRONT ANCHOR POINTS IN HIGH POSITION

1. Retaining bolt
2. Seat support

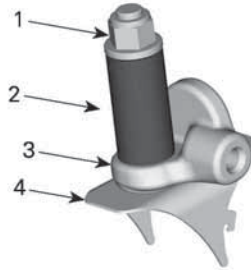

### REAR ANCHOR POINT IN HIGH POSITION

1. Retaining nut
2. Sleeve
3. Seat frame
4. Vehicle frame

### **⚠ WARNING**

Use new nuts when installing seat anchor points. Ensure both anchor points at the front and both anchor points at the rear are set to the same position (HIGH or LOW) before riding the vehicle.

Install both front anchor points as shown. Use **NEW** nuts.

Tighten nuts to specification.

### Tightening Torque

Rear anchor point	105 ± 15 Nm (77 ± 11 lbf-ft)
Front anchor point	24.5 ± 3.5 Nm (18 ± 3 lbf-ft)

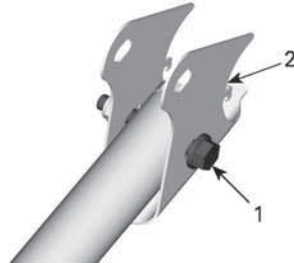

### FRONT ADJUSTMENT MECHANISM IN POSITION LOW

1. Retaining bolt
2. Bracket support

### Setup in LOW Position

Remove the seat cushion.

Remove both nuts securing the rear anchor points.

Remove both nuts securing the front anchor points.

Assemble both rear anchor points as shown. Use **NEW** nuts.

### **⚠ WARNING**

Use new nuts when installing seat anchor points. Ensure both anchor points at the front and both anchor points at the rear are set to the same position (HIGH or LOW) before riding the vehicle.

Tighten nuts to specification.

Tightening Torque	
Rear anchor points	105 ± 15 Nm (77 ± 11 lbf-ft)
Front anchor points	24.5 ± 3.5 Nm (18 ± 3 lbf-ft)

## Fuel Reservoir Cap

Open fuel reservoir cap cover.



1. Fuel reservoir cap cover

The fuel reservoir cap is located at front on the right hand side of the vehicle.

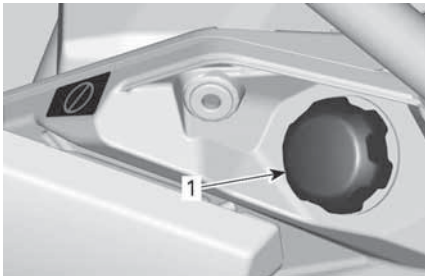

1. Fuel reservoir cap

Refer to *Fuel* for information on fueling procedure and fuel requirements.

## Cargo Rack

Cargo rack is convenient for carrying equipment and various other cargo. It must never be used to carry a passenger.

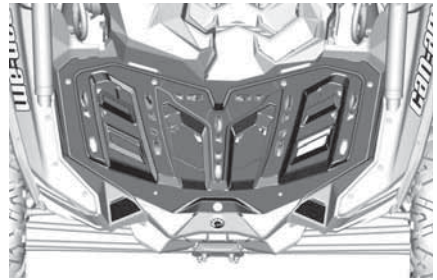

CARGO RACK

### ⚠ WARNING

- Never carry a passenger on a cargo rack.
- Cargo must never interfere with the drivers line of sight or affect his ability to properly steer the vehicle.
- Do not overload the vehicle.
- Always ensure all cargo is properly secured and does not extend out passed the rack.
- Never carry gasoline container (s) or any dangerous liquids on the cargo rack.

Refer to *Technical Specifications* for cargo weight recommendations.

## Recovery Hook

Convenient hook that can be used to recover a stuck vehicle.

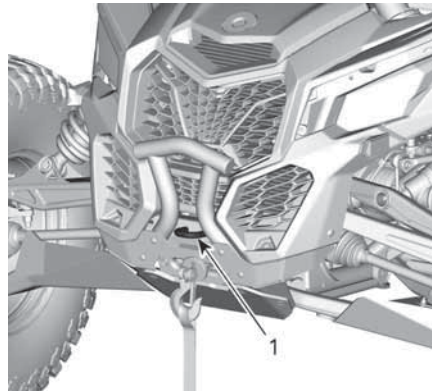

1. Front recovery hook

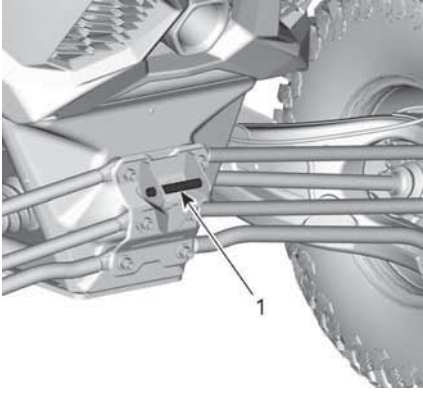
**ALL MODELS**

1. Rear recovery hook

**NOTICE**

Recovery hooks are designed to recover a stuck vehicle, they should not be used to carry a load, to attach a pulley or other mechanical devices that can overload the attachment point. Failure to do so can cause damages to the vehicle frame.

**Wheel Scraper**

Located inside the rear wheels to reduce accumulation of mud in the wheels that can damage parts inside the wheels.

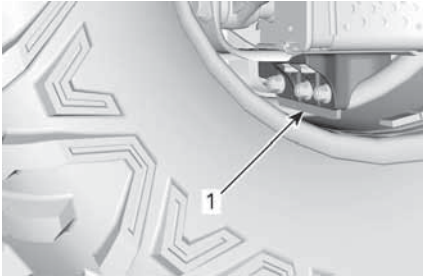

1. Wheel scraper

Check wheel scraper condition. Replace when wear exceeds wear limit at any location.

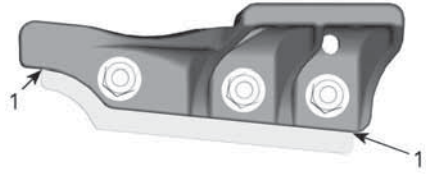

1. Wear limit

**12-Volt Power Outlet**

Convenient for handheld spotlight or other portable equipment.

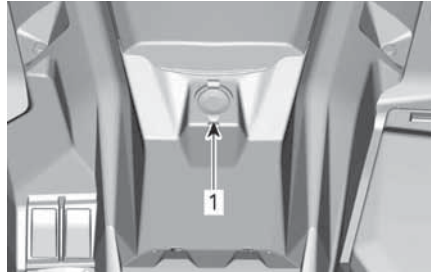

1. 12 V power outlet

Remove protective cap to use. Always reinstall it after use to protect against weather.

**Central Rearview Mirror**

This vehicle comes equipped with a central rearview mirror.

Be aware that objects in mirror are closer than they appear.

The mirror can be adjusted to suit driver's preference.

To adjust mirror; loosen knob located behind mirror and tighten it to secure mirror in position.

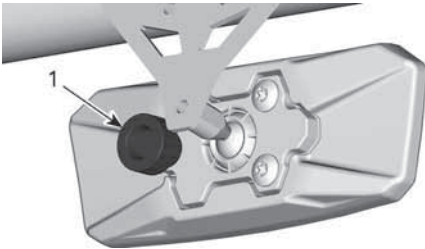
**BEHIND THE MIRROR**

1. Knob

**⚠ WARNING**

**Do not adjust mirrors while riding.  
You could lose control.**

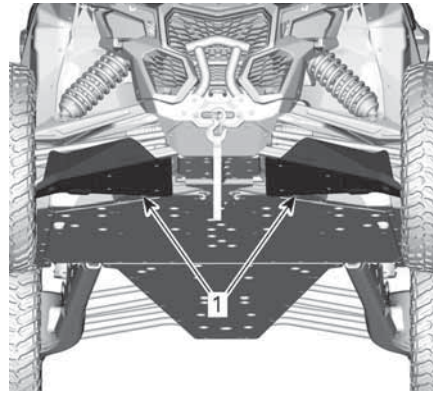

1. A-Arm Protector

## Rock Sliders and Suspension Arm Protectors (if Equipped)

UHMW rock sliders for additional lower body protection.

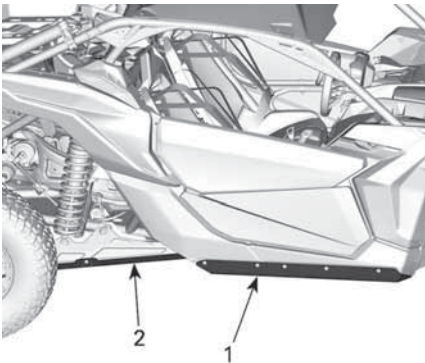

1. Rock sliders
2. Trailing arm protector

## Winch (If Equipped)

**⚠ WARNING**

**To avoid severe injury or death or important components damages.**

- Never use the winch cable/rope to retain a vehicle during trailering.
- Never ride with the winch cable/rope attached to a load or another vehicle.
- Only use the winch to help a stuck vehicle (snow, mud, etc.).
- Always refer to the winch manufacturer's instruction before pulling loads.

The winch can be actuated inside the vehicle using the winch control switch on the upper console.

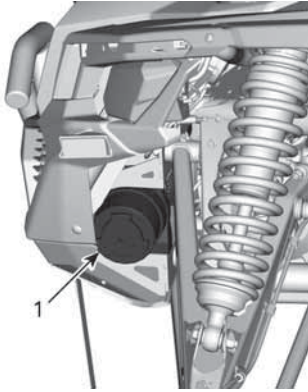

1. Winch

**NOTE:**

Using the winch intensively over a long period of time may discharge the battery.

The following tips will help to reduce the risk of discharging the battery:

Always unreel manually: Unlock the cable using the handle then pull on the hook strap to unreel.

It is recommended to let the vehicle run while winching. Do not stop vehicle immediately after winching to let battery recharge.

Also, when winching for more than 30 seconds, it is recommended to increase engine RPM in the range of 3000 RPM to increase charging power to the battery.

**NOTE:**

Make sure vehicle is in NEUTRAL (N) before increasing engine RPM.

Refer to your winch *Guide* included with your vehicle for proper winch operation.

Intensive use of the winch may cause the built-in circuit breakers to momentarily turn OFF. In such a case, wait a moment, then continue winching. the

breakers automatically turn ON once they cooled down.



# TUNE YOUR RIDE

## DPS Function

The Tri-Mode Dynamic Power Steering (DPS) offers easy steering assistance to the rider. The level of assistance will automatically adapt according to the vehicle's speed and rider's demand, in order to provide maximum steering power at lower speed where the demand is normally higher. As speed increases, the assistance is progressively reduced to keep maximum steering feel and precision to the rider.

It is possible to choose between three modes of assistance: Minimum, Medium and Maximum. Each mode will continue to automatically adapt to the vehicle's speed and rider's demand, so it does not require to be changed when riding. These modes are used to set the level of assistance to match each rider's preferences.

The following DPS modes are preset in the vehicle.

DPS MODE	
DPS MAX.	Maximum steering assist
DPS MED.	Medium steering assist
DPS MIN.	Minimum steering assist

To show the active DPS mode, proceed as follows:

1. Press and release **DPS** button.

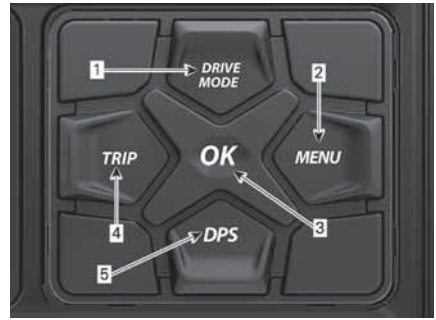

1. **DPS** button
2. Check the multifunction gauge to confirm the active DPS mode.

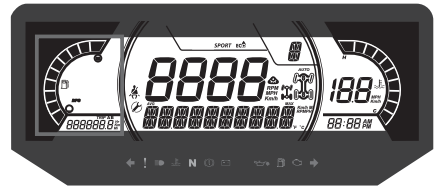

### 7.6 DIGITAL DISPLAY

To change the DPS mode, proceed as follows:

3. Press and release **DPS** button.
4. Check the multifunction gauge to confirm the active DPS mode.
5. Press and hold **DPS** button for 2 seconds to go to the next setting.
6. Release **DPS** button.
7. Repeat until desired setting is selected.

### NOTE:

The DPS adjustment will not be possible if the gearbox is set to **REVERSE**.

## Suspension Adjustment Guidelines

Your vehicle handling and comfort depend upon suspension adjustments.

**⚠ WARNING**

**Suspension adjustment could affect vehicle handling. Always take time to familiarize yourself with the vehicle's behavior after any suspension adjustment has been made.**

Choice of suspension adjustments vary with vehicle load, personal preference, riding speed and terrain condition.

The best way to set up the suspension, is to start from factory settings, then customize each adjustment one at a time.

Front and rear adjustments are inter-related. It may be necessary to readjust the rear shock absorbers after adjusting front shock absorbers for instance.

Test run the vehicle under the same conditions; trail, speed, load, etc. Change one adjustment and retest. Proceed methodically until you are satisfied.

Following are guidelines to fine-tune suspension. Use suspension adjustment tool provided in the tool kit.

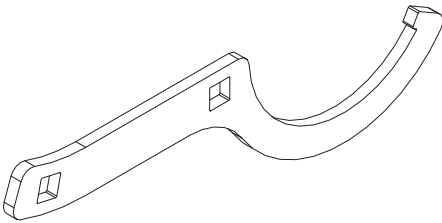

**SUSPENSION ADJUSTMENT TOOL**

**Adjustment Location**

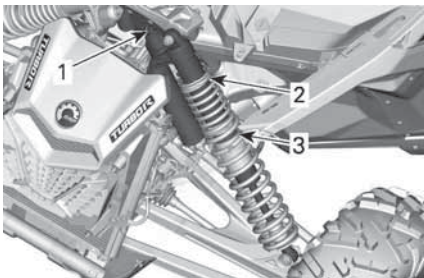

**TYPICAL - WITHOUT REBOUND DAMPING - FRONT SUSPENSION**

1. Compression damping
2. Preload
3. Spring Crossover

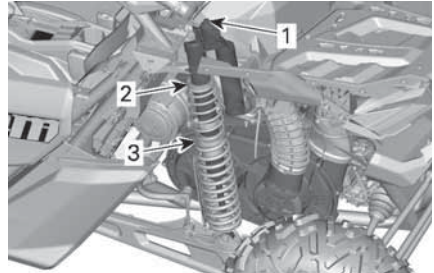

**TYPICAL - WITHOUT REBOUND DAMPING - REAR SUSPENSION**

1. Compression damping
2. Preload
3. Spring Crossover

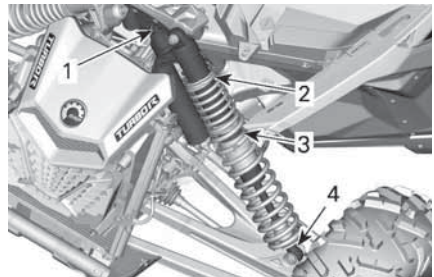

**TYPICAL - WITH REBOUND DAMPING - FRONT SUSPENSION**

1. Compression damping (high speed and low speed)
2. Preload
3. Spring Crossover
4. Rebound damping

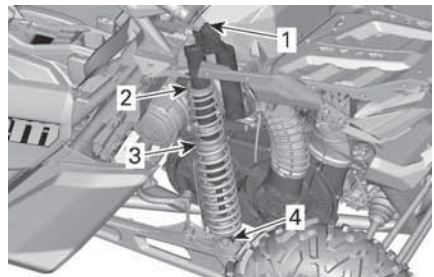

**TYPICAL - WITH REBOUND DAMPING - REAR SUSPENSION**

1. Compression damping (high speed and low speed)
2. Preload
3. Spring Crossover
4. Rebound damping

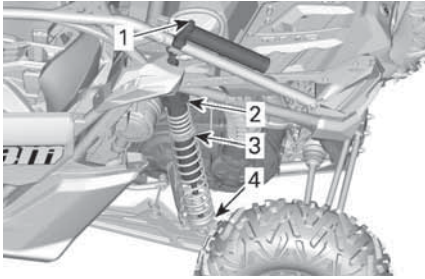

**TYPICAL - WITH REBOUND DAMPING AND REMOTE RESERVOIR - REAR SUSPENSION**

1. Compression damping (high speed and low speed)
2. Preload
3. Spring Crossover
4. Rebound damping

## Suspension Factory Settings

For adjustment procedures, refer to *Suspension Adjustments* in this section.

To adjust compression and rebound to factory settings, proceed as follows:

1. Turn adjuster clockwise until it stops.
2. Turn adjuster counterclockwise by the specified amount, see table below.

Front Suspension Factory Settings		
Adjustment	Model	Factory Setting
Spring preload	Maverick DS TURBO Maverick DS TURBO RR Maverick X ds TURBO RR Maverick X rc TURBO RR 64 in	58.4 mm (2.29 in)
	Maverick RS TURBO RR	39 mm (1.53 in)
	Maverick X rc TURBO RR 72 in	82.9 mm (3.26 in)
	Maverick X rs TURBO RR	33 mm (1.30 in)
	Maverick X rs TURBO RR with Smart-Shox	32.8 mm (1.29 in)
Compression damping	Maverick DS TURBO Maverick X rc TURBO RR 64 in Maverick DS TURBO RR  Maverick RS Turbo RR	Position 2

### Front Suspension Factory Settings

Adjustment	Model	Factory Setting
Compression damping (low speed)	Maverick X ds TURBO RR	2 Turns
	Maverick X rs TURBO RR Maverick X rc TURBO RR 72 in	3 Turns
Compression damping (high speed)	Maverick X ds TURBO RR	2 Turns
	Maverick X rs TURBO RR Maverick X rc TURBO RR 64 in	3 Turns
Rebound damping	Maverick X ds TURBO	Position 12
	Maverick X rc TURBO RR 72 in Maverick X rs TURBO RR	Position 19
Crossover ring position	Maverick DS TURBO Maverick X rc TURBO RR 64 in	88.6 mm (3.48 in)
	Maverick X rc TURBO RR 72 in	71.6 mm (2.81 in)
	Maverick X rs TURBO RR	89.6 mm (3.52 in)
	Maverick X rs TURBO RR with Smart-Shox	72.8 mm (2.86 in)

### Rear Suspension Factory Settings

Adjustment	Model	Factory Setting
Spring preload	Maverick DS TURBO Maverick X ds TURBO RR Maverick X rc TURBO RR 64 in	153.7 mm (6.03 in)
	Maverick RS TURBO RR	191.3 mm (7.51 in)
	Maverick X rc TURBO RR 72 in	185.3 mm (7.28 in)

<b>Rear Suspension Factory Settings</b>		
<b>Adjustment</b>	<b>Model</b>	<b>Factory Setting</b>
Spring preload	Maverick X rs TURBO RR	188.5 mm (7.4 in)
	Maverick X rs TURBO RR with Smart-Shox	191 mm (7.5 in)
Compression damping	Maverick DS TURBO Maverick X rc TURBO RR 64 in	Position 2
Compression damping (low speed)	Maverick X ds TURBO RR	3 Turns
	Maverick X rs TURBO RR Maverick X rc TURBO RR 72 in	2 Turns
Compression damping (high speed)	Maverick X rs TURBO RR Maverick X rc TURBO RR 72 in	2 Turns
Rebound damping	Maverick X ds TURBO RR	Position 15
	Maverick X rs TURBO RR Maverick X rc TURBO RR 72 in	Position 12
Crossover rings position	Maverick DS Turbo Maverick DS Turbo RR Maverick X ds TURBO RR Maverick X rc TURBO RR 64 in	68.6 mm (2.69 in)
	Maverick RS TURBO RR	96.1 mm (3.77 in)
	Maverick X rs Turbo RR	72.8 mm (2.86 in)
	Maverick X rc TURBO RR 72 in	81 mm (3.18 in)
	Maverick X rs TURBO RR with Smart-Shox	64.5 mm (2.53 in)

## Suspension Adjustments

### Spring Preload Adjustment

Shorten the spring for a firmer ride and rough riding condition or when pulling a trailer (if equipped with hitch).

Lengthen the spring for a softer ride and smooth riding condition.

#### **⚠ WARNING**

**The left and right shock adjustment on front or rear suspension must always be set to the same position. Never adjust one shock only. Uneven adjustment can cause poor handling and loss of stability, which could lead to an accident.**

Lift the vehicle. Spring length should be measured without load on the wheels.

Spring length should be equal on both sides.

Adjust by loosening lock ring and turning adjuster ring as desired. Use tool from vehicle tool kit.

#### **NOTE:**

Factory settings are suitable for almost all conditions. Take into consideration that an increase in ground clearance can affect the handling of the vehicle.

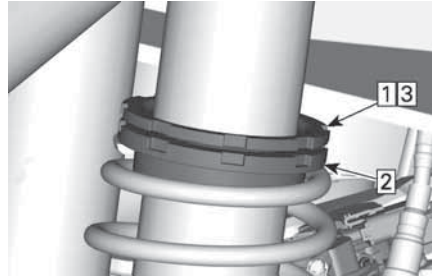

#### **TYPICAL**

1. Loosen top locking ring
2. Turn adjusting ring accordingly
3. Tighten top locking ring

### Adjusting Spring Crossover

Dual compression rate crossover point can be modified by adjusting the crossover rings position. See an authorized Can-Am dealer.

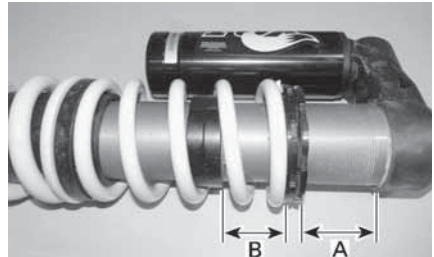

#### **TYPICAL - CROSSOVER ADJUSTMENT - REAR SHOCK**

- A. Spring preload
- B. Crossover ring position

### Shock Damping Adjustments (If Equipped)

Compression damping controls how the shock absorber reacts when riding.

Position	Setting	Result on Big Bumps
1	Soft	Softer compression damping
2	Medium (Factory)	Medium compression damping
3	Hard	Firmer compression damping

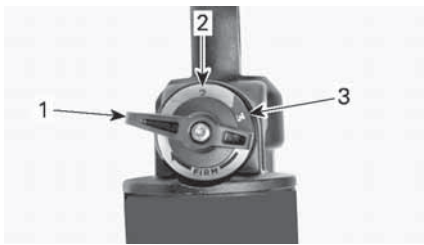

1. Position 1
2. Position 2
3. Position 3

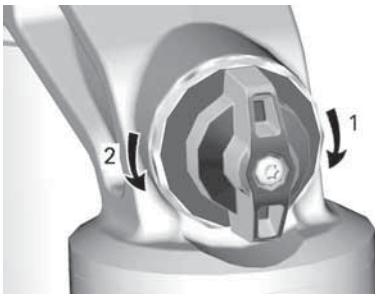

#### COMPRESSION DAMPING

1. **Increases** damping (stiffer)
2. **Decreases** damping (softer)

Turn adjuster clockwise to **increase** shock damping action (stiffer).

Turn adjuster counterclockwise to **decrease** shock damping action (softer).

Action	Result
Increasing compression damping force	Firmer compression damping
Decreasing compression damping force	Softer compression damping

#### **WARNING**

**Make sure compression damping setting is the same on both sides.**

#### *Low Speed Compression Damping (If Equipped)*

Low speed compression damping controls how the shock absorber reacts to a low suspension velocity (slow compression strokes, in most cases when riding at lower speeds).

Action	Result on Big Bumps
Increasing low speed compression damping force	Firmer compression damping (slow compression)
Decreasing low speed compression damping force	Softer compression damping (slow compression)

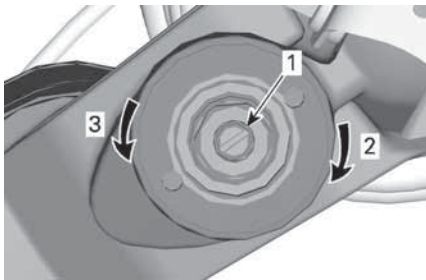

**LOW SPEED COMPRESSION DAMPING  
(USE A SCREWDRIVER)**

1. Adjustment screw
2. **Increases** compression damping (stiffer)
3. **Decreases** compression damping (softer)

Turning it clockwise (H) **increases** shock damping action (stiffer).

Turning it counterclockwise (S) **decreases** shock damping action (softer).

**High Speed Compression Damping  
(If Equipped)**

High speed compression damping controls how the shock absorber reacts to a high suspension velocity (quick compression strokes, in most cases when riding at higher speeds).

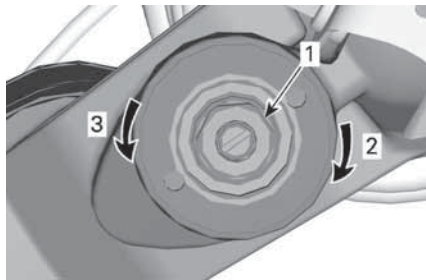

**HIGH SPEED COMPRESSION DAMPING  
(USE A 17 MM WRENCH)**

1. Adjustment screw
2. **Increases** compression damping (stiffer)
3. **Decreases** compression damping (softer)

**Rebound Damping (If Equipped)**

Use a flat screwdriver to adjust it.



1. Rebound adjuster
2. **Increases** rebound (stiffer)
3. **Decreases** rebound (softer)

Action	Result on Small Bumps
Increasing high speed compression damping force	Firmer compression damping (fast compression)
Decreasing high speed compression damping force	Softer compression damping (fast compression)

**Smart-Shox Suspension Mode**

The Smart-Shox suspension is an electronic-controlled compression and rebound damping system integrated in each shock absorbers.

It is possible to choose between three modes of damping. These modes set the level of damping to match the rider's preferences.

The following Smart-Shox modes are preset in the vehicle.



Smart-Shox MODE	
COMFORT	This mode provides maximum comfort. The suspension moves freely while controlling body movement to avoid bottoming out and enhance cornering and acceleration.
SPORT	This mode enhance handling and provides comfort in straight line. The suspension minimizes body movement in cornering, accelerating and braking while offering optimal calibration to face bumpy trails.
SPORT+	This mode is all about performance, forget comfort. In full stiffness all the time and ready to tackle the most extreme situations.



2. Check the multifunction gauge to confirm the active Smart-Shox mode.



To select the Smart-Shox mode, proceed as follows:

1. Position the button on the desired mode.

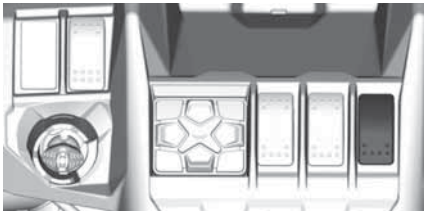

The shock icon is blinking when changing the mode.

# FUEL

## Fuel Requirements

### NOTICE

**Always use fresh gasoline. Gasoline will oxidize; the result is loss of octane, volatile compounds, and the production of gum and varnish deposits which can damage the fuel system.**

Alcohol fuel blending varies by country and region. Your vehicle has been designed to operate using the recommended fuels, however, be aware of the following:

- Use of fuel containing alcohol above the percentage specified by government regulations is not recommended and can result in the following problems in the fuel system components:
  - Starting and operating difficulties.
  - Deterioration of rubber or plastic parts.
  - Corrosion of metal parts.
  - Damage to internal engine parts.
- Inspect frequently for the presence of fuel leaks or other fuel system abnormalities if you suspect the presence of alcohol in gasoline exceeds the current government regulations.
- Alcohol blended fuels attract and hold moisture which may lead to fuel phase separation and can result in engine performance problems or engine damage.

### **Recommended Fuel**

Use premium unleaded gasoline with an AKI (R+M)/2 octane rating of 91, or an RON octane rating of 95.

Use unleaded gasoline containing **MAXIMUM 10%** ethanol.



### NOTICE

**Never experiment with other fuels. Engine or fuel system damages may occur with the use of an inadequate fuel.**

### NOTICE

**Do NOT use fuel from fuel pumps labeled E85.**

Use of fuel labeled E15 is prohibited by U.S. EPA Regulations.

## Vehicle Fueling Procedure

### **WARNING**

- **Fuel is flammable and explosive under certain conditions.**
- **Never use an open flame to check fuel level.**
- **Never smoke or allow flame or spark in vicinity.**
- **Always work in a well-ventilated area.**
- **Vehicle must be on a level surface to perform fueling.**

1. Place vehicle on a level surface.
2. Stop engine.

### **WARNING**

**Always stop engine before refueling.**

3. Have driver and passenger get out of vehicle.

**⚠ WARNING**

Do not allow anyone to remain in the vehicle while fueling. If there is a fire or explosion during fueling, a vehicle occupant could be unable to quickly leave the area.

4. Open the fuel reservoir cap cover.

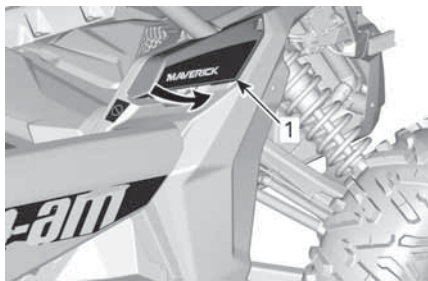

1. Fuel reservoir cap cover

5. Slowly unscrew the fuel reservoir cap counterclockwise to remove it.

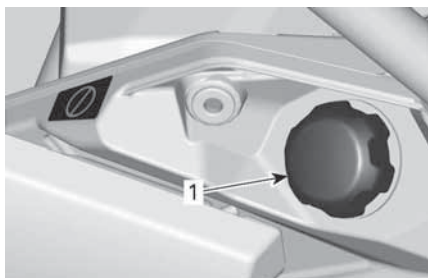

1. Fuel reservoir cap

**⚠ WARNING**

If a differential pressure condition is noticed (whistling sound heard when loosening fuel reservoir cap) have vehicle inspected and/or repaired before further operation.

6. Insert the spout into the filler neck.
7. Pour fuel slowly so that air can escape from the tank and prevent fuel flow back. Be careful not to spill fuel.

8. Stop filling when the fuel reaches the bottom of filler neck. Do not overfill.

**⚠ WARNING**

Never top up the fuel tank before placing the vehicle in a warm area. As temperature increases, fuel expands and may overflow.

9. Fully tighten fuel reservoir cap clockwise until you hear a clicking noise.

**⚠ WARNING**

Always wipe off any fuel spillage from the vehicle.

---

# BREAK-IN PERIOD

## Operation During Break-In

A break-in period of 10 operating hours or 300 km (200 mi) is required for the vehicle.

### *Engine*

During the break-in period:

- Avoid full throttle operation.
- Avoid pressing accelerator pedal more than 3/4 of the stroke.
- Avoid sustained accelerations.
- Avoid prolonged cruising speeds.
- Avoid engine overheating.

However, brief accelerations and speed variations contribute to a good break-in.

### *Brakes*

 <b>WARNING</b>
--

<p><b>New brakes will not operate at their maximum efficiency until their break-in is completed. Braking performance may be reduced, so use extra caution.</b></p>
--

### *Drive Belt*

A new belt requires a break in period of 50 km (30 mi).

During the break-in period:

- Avoid strong acceleration and deceleration.
- Avoid pulling a load.
- Avoid high speed cruising.

# BASIC PROCEDURES

## Starting the Engine

Install D.E.S.S. key on D.E.S.S. post.

Press the brake pedal.

### NOTE:

If shift lever is not set to PARK (P) or (N) NEUTRAL, the brake pedal must be pressed to allow engine starting.

Press the engine start button and hold until the engine starts.

### NOTE:

Do not press the accelerator pedal. If the accelerator pedal is pressed at least 20%, the engine will not start.

Release the engine start button immediately when the engine has started.

### NOTICE

**If engine does not start after a few seconds, do not hold the engine start button more than 10 seconds. Refer to *Troubleshooting* section.**

Wait approximately 10 seconds to let engine oil flow through engine and turbo.

## Waking Up the Electrical System

Press and release the START button for less than half a second and the electrical system will turn ON:

- For 20 seconds, **without** powering any equipment, if the D.E.S.S. key is **NOT** installed on the D.E.S.S. post.
- For 10 minutes, powering equipment, if the D.E.S.S. key is installed on the D.E.S.S. post. The electrical system will shutdown after 20 seconds if the D.E.S.S. key is removed.

### NOTICE

**Waking up the electrical system repeatedly or using electrical equipment will discharge the battery and you may not be able to start the engine.**

## Operating the Shift Lever

Apply brakes and select the desired shift lever position.

Release brakes.

### NOTICE

**When changing gear selection, always completely stop the vehicle and apply the brakes prior to shifting. Damage to the gearbox may occur.**

## Choosing the Correct Range (Low or High)

It is important to limit situations known to make the drive belt slip excessively. The main reason the drive belt will slip is if the gearbox is in high range when it should be in low range.

Pay attention to the following:

### Low Range

Low range should be used whenever:

- Pulling
- Pushing
- Hauling a load
- 4x4 applications
- Mud holes
- Water holes
- Crossing obstacles
- Climbing onto trailer
- Hill climbing

It is also recommended to use low range if driving for prolonged periods at speeds under 24 km/h (15 MPH)

Please refer to *Break-In Period* in this guide for information in regards to belt break-in period.

## High Range

High is the default riding range.

### *Electronic Drive Belt Protection (if available and activated on your model)*

Some vehicles have the electronic drive belt protection function activated.

Refer to your authorized Can-Am dealer for availability and possible activation.

This function is activated when riding at too slow speed for the **high range**, such as in the following situations:

- Pulling
- Pushing
- Hauling a load
- 4x4 applications
- Mud holes
- Water holes
- Crossing obstacles
- Climbing onto trailer
- Hill climbing

In the above mentioned situations the electronic drive belt protection will help protect the CVT drive belt from being damaged by activating the engine torque limiter. The gauge will also scroll a **LOW GEAR** message, suggesting the operator to immobilize the vehicle and set to **LOW GEAR**.

**Whenever the electronic drive belt protection is activated, you MUST shift in LOW range.** Refer to *Operating the Shift Lever*.

If the situation does not allow you to shift in **LOW** range, it is possible to temporarily deactivate the electronic drive belt protection by pressing on the override switch. Refer to *override switch*.

## WARNING

**DO NOT USE THE OVERRIDE SWITCH** if the slope is too steep and that there might be a risk of tipover. Apply brakes to immobilize vehicle. Put shift lever in reverse (R), and back down the hill, barely releasing brakes to remain at low speed. Do not attempt to turn around. Never coast down hill while vehicle is in neutral. Do not perform hard braking as it increases the risk of tipover.

## Stopping the Engine and Parking the Vehicle

### WARNING

Avoid parking on steep slope as the vehicle may roll away.

### WARNING

Always put the vehicle in **PARK** when stopped or parked to prevent rolling.

### WARNING

Avoid parking in places where hot parts can start a fire.

When stopped or parked always bring shift lever to park position. This is especially important when parking on a slope. On very steep inclines or if the vehicle is carrying a cargo, the wheels should be blocked using rocks or bricks.

Select the flattest terrain available for parking.

Release accelerator pedal and use brakes to completely stop the vehicle.

Set shift lever in **PARK** position.

Press the start / stop button to stop the engine.

Remove D.E.S.S key from its post.

If you must park on a steep incline or if the vehicle is carrying cargo, block the wheels using rocks or bricks.

Before stopping the engine and parking the vehicle following a more intense ride, let vehicle run idle for a period of 20 to 30 seconds to allow for cooling of the turbo system.

## Tips for Maximizing Drive Belt Durability

Riding style and conditions have a direct impact on drive belt durability. Your vehicle features a CVT system design that is optimized to offer the best performance. The CVT and drive belt have successfully endured thousands of miles of durability tests. However, to maximize drive belt durability and to prevent premature failures, it is important that the operator understands the limits of a belt driven CVT system and adapts their riding style and speed accordingly.

If riding in any of the conditions listed below, BRP highly recommends not to constantly hold the throttle wide open (WOT) for more than five (5) minutes.

- High ambient temperatures (above 30 °C/86 °F)
- Heavy loads: Passengers / Heavy cargo
- Heavy drag: Soft sand / Hill climbing / Mud / Using a track kit.

After a few minutes at WOT, partially release the accelerator and allow the CVT to cool down.

For more tips for maximizing the drive belt durability, refer to *Choosing the Correct Range (Low or High)*.

# SPECIAL PROCEDURES

## What to do if Water Entered the CVT

If water is present in the CVT, the engine will accelerate but the vehicle will remain still.

### NOTICE

Stop the engine and drain the water to avoid damage to the CVT.

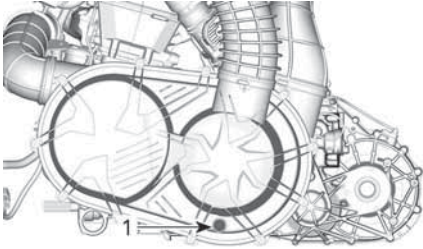

1. CVT drain

The CVT drain is accessible from under the rear of vehicle on the LH side.

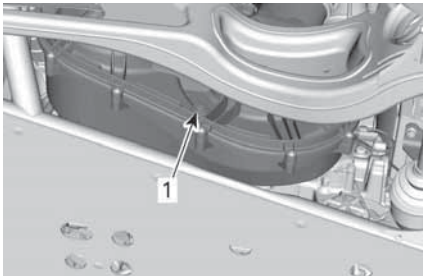

1. CVT drain

See an authorized Can-Am dealer to have the CVT inspected and cleaned.

## What to do if Battery is Drained Out

The vehicle can be jump started by using the red (+) cable to the battery positive pole and the black (-) cable to the vehicle chassis.

To access the battery, move the passenger seat completely forward. Refer to *Seats in Equipment*.

### NOTICE

Do not connect any electrical source to the steering column or components which are in contact with DPS.

## What to Do if Vehicle Rolled Over

Abrupt maneuvers, sharp turns, side hilling or accident may cause vehicle to rollover.

Should the vehicle be rolled over, it will be necessary to have it transported to an authorized Can-Am Off-road dealer for inspection as soon as possible. **NEVER START THE ENGINE!**

Points to be verified, including but not limited to:

- All fluid levels
- Seat belts, including retractors, buckles and semi-cinching tabs
- Cage and its attachment points
- Steering system
- Suspension and its attachment points.

## What to do if Vehicle is Submerged

Should the vehicle become immersed, it will be necessary to have it transported to an authorized Can-Am Off-road dealer as soon as possible.

### NOTICE

Never start the engine as immersion of the vehicle can cause serious damage to the engine if the correct restart procedure is not followed.



# TRANSPORTING THE VEHICLE

When contacting a towing or transporting service, be sure to ask if they have a flatbed trailer, loading ramp or power ramp to safely lift the vehicle and tie-down straps. Ensure the vehicle is properly transported as specified in this section.

## NOTICE

**Do not tow this vehicle — towing can seriously damage the vehicle's drive system.**

## NOTICE

**Avoid using chains to tie the vehicle — they may damage the surface finish or plastic components.**

## WARNING

**To avoid severe injury or death or important components damages.**

- Never use the winch cable/rope to retain a vehicle during trailering.
- Never ride with the winch cable/rope attached to a load or another vehicle.
- Only use the winch to help a stuck vehicle (snow, mud, etc.).
- Always refer to the winch manufacturer's instruction before pulling loads.

## WARNING

**Make sure no loose objects are present inside vehicle during vehicle transportation.**

## WARNING

**Always transport the vehicle facing forward to avoid damaging the windshield or other components. Parts may detach during transport.**

## WARNING

**Before attempting to mount vehicle onto a platform or a trailer, make sure to respect the following safety precautions.**

## SAFETY PRECAUTIONS

Carrying equipment	The carrying item (platform or trailer or flat bed) must be of appropriate dimensions and capacity to safely support and transport the vehicle.
Hauling vehicle	Do not exceed vehicle hauling capacity and specifications. Ensure the trailer or platform is properly secured to the hauling vehicle hitch.
Visibility	Ensure you have a good visibility during the entire maneuver.
Terrain	The hauling vehicle and trailer must be on a leveled surface. Use wheel chocks on trailer and hauling vehicle to avoid any movement.
Ramps	Use ramps with proper rating and secure ramps to the trailer or platform. Avoid steep ramps.
Bystanders	Always make sure bystanders are not close to the vehicle or the trailering equipment while climbing up.

## Using Vehicle Power to Climb Onto Trailering Equipment

When vehicle can climb on its own power, proceed as follows;

1. Wear protective gear.
2. Fasten seat belt.
3. Use low gear only (if equipped).
4. If vehicle has 4WD option, use it.
5. When driving remain seated at all times.
6. Ensure proper alignment on rails or platform.
7. Start from a sufficient distance from the trailer to align the vehicle in a straight line with the ramps. Never attempt to turn while getting closer to the ramp. Rear wheels might not be aligned once you get to the ramp and vehicle may fall off.
8. Slowly climb the front wheels onto the ramp to verify alignment.
9. Back off the vehicle, verify ramps are still secure, then proceed at proper speed.
10. Carefully drive vehicle onto platform or trailer. Use sufficient speed to climb without spinning or abruptly accelerating. Avoid acceleration while on ramps to prevent ramps movement.
11. If trailer is inclined towards front, simply let vehicle roll in without acceleration.
12. Once vehicle is climbed, put shift lever to Park. Apply brake locking mechanism (if equipped).

**When vehicle cannot move on its own power, or in case overshooting is a risk or if any dangerous condition prevents for embarking on its own power, proceed using a winch;**

## Using a Winch to Pull Vehicle Onto Trailering Equipment

**When vehicle cannot climb on its own power, proceed as follows;**

### **WARNING**

**Have the help of an assistant. One person should be in vehicle to have access to vehicle steering, brakes and winch switch, while the other person controls the environment and safety of the maneuver.**

### **WARNING**

**Ensure the winch hook can be safely attached to a proper anchoring point. Use proper rigging.**

### **NOTE:**

If vehicle can be started safely, let engine idle during winching to avoid draining the battery.

1. Place shift lever to NEUTRAL (N).
2. If the vehicle is equipped with a winch, use the winch to roll the vehicle on the platform.
3. If the vehicle is not equipped with a winch, proceed as follows:
  1. Attach strap to lower front bumper anchor.
  2. Attach the strap to the winch cable of the towing vehicle.
  3. Pull the vehicle on the flatbed trailer with the winch.
4. Put shift lever to Park. Apply brake locking mechanism (if equipped).

## Securing Vehicle for Transport

### ⚠ WARNING

To avoid severe injury or death or important components damages.

- Never use the winch cable/rope to retain a vehicle during trailering.
- Never ride with the winch cable/rope attached to a load or another vehicle.
- Only use the winch to help a stuck vehicle (snow, mud, etc.).
- Always refer to the winch manufacturer's instruction before pulling loads.

1. Remove the key from the D.E.S.S. post.
2. At rear, secure the vehicle on both sides using a strap around the suspension arm as close to the wheel as possible.
3. At front, secure the vehicle on both sides using a strap around the lower suspension arm as close to the wheel as possible.

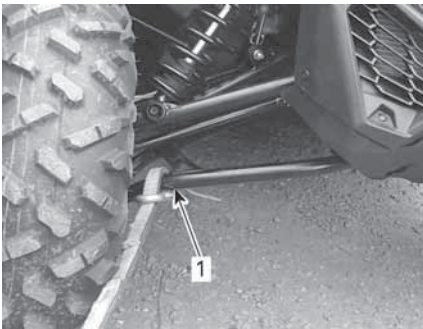

1. *Front lower suspension arm*
4. Strap the rear tires by using tire towing straps.
5. Firmly attach the rear suspension tie-down straps to both sides of the rear of the trailer with ratchets.

6. Ensure that both the front and rear wheels are firmly attached to the trailer.

## Getting Vehicle Out of Trailer

### ⚠ WARNING

Vehicle may have moved during transport. Ensure vehicle is properly aligned with ramps before proceeding.

### ⚠ WARNING

Visibility will be greatly reduced when backing off from the trailer. Have the help of an assistant to ensure proper alignment and safe environment.

# LIFTING AND SUPPORTING THE VEHICLE

## Front of Vehicle

Place vehicle on a flat non slippery ground.

Engage the 4WD mode.

Ensure vehicle shift lever is set to PARK.

Install an hydraulic jack under the round tube.

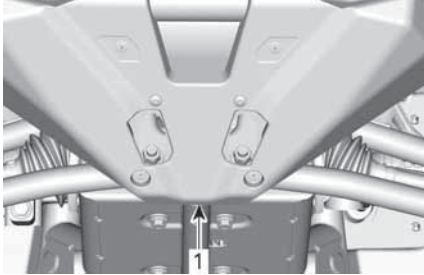

**FRONT OF VEHICLE**

1. Hydraulic jack position

Lift front of vehicle and install a jack stand on each side under frame as shown below:

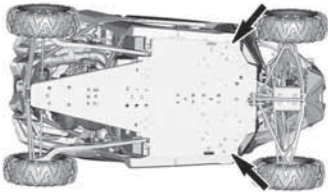

**JACK STAND POSITIONS - FRONT OF VEHICLE**

Lower hydraulic lift and ensure vehicle is supported safely onto both jack stands.

## Rear of Vehicle

Place vehicle on a flat non slippery ground.

Activate 4WD mode.

Ensure vehicle shift lever is set to PARK.

Install an hydraulic jack under the vehicle.

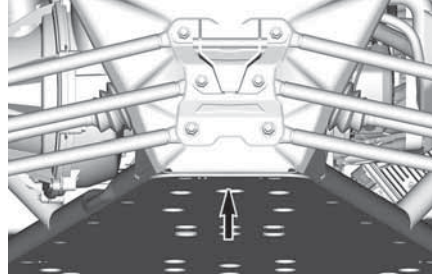

**REAR OF VEHICLE**

1. Hydraulic jack position

Lift rear of vehicle and install a jack stand on each side under frame as shown below:

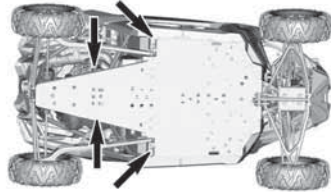

**JACK STAND POSITIONS - REAR OF VEHICLE**

Lower hydraulic lift and ensure vehicle is supported safely onto both jack stands.

# MAINTENANCE

---

# MAINTENANCE SCHEDULE

Maintenance is very important to keep your vehicle in safe operating condition. The vehicle should be serviced as per the maintenance schedule.

Proper maintenance is the owner's responsibility. A warranty claim may be denied if, among other things, the owner or operator caused the problem through improper maintenance or use.

Perform periodic checks and follow the maintenance schedule. **The maintenance schedule does not exempt the pre-ride inspection.**

Verifying fault codes, as first maintenance step, is a good practice and is highly recommended.

## WARNING

**Failure to properly maintain the vehicle according to the maintenance schedule and procedures can make it unsafe to operate.**

## EPA Regulation - Canadian and USA Vehicles

A repair shop or person of the owner's choosing may maintain, replace, or repair emission control devices and systems. These instructions do not require components or service by BRP or authorized Can-Am Off-road dealers.

Although an authorized Can-Am Off-road dealer has an in-depth technical knowledge and tools to service your vehicle, the emission-related warranty is not conditioned on the use of an authorized Can-Am Off-road dealer or any other establishment with which BRP has a commercial relationship.

Proper maintenance is the owner's responsibility. A warranty claim may be denied if, among other things, the owner or operator caused the problem through improper maintenance or use.

For emission-related warranty claims, BRP is limiting the diagnosis and repair of emission-related parts to the authorized Can-Am Off-road dealers. For more information, please refer to the *US EPA Emission-Related Warranty* contained in the *Warranty* section.

You must follow the instructions for fuel requirements in the fueling section of this manual. Even if gasoline containing greater than ten volume percent ethanol is readily available, the US EPA issued a prohibition against the use of gasoline containing greater than 10 vol% ethanol that applies to this vehicle. The use of gasoline containing greater than 10 vol% ethanol with this engine may harm the emission control system.

## Air Filter Maintenance Guideline

Air filter maintenance should be adjusted according to riding conditions.

Air filter maintenance must be increased in frequency when riding on snow, dry sand, dirt, gravel or similar conditions which have a high dust or particle dispersion.

Riding in a group in these conditions will require increasing the air filter maintenance frequency further.

**NOTE:**

Accessory filters and pre-filter are available for such conditions. Contact an authorized Can-Am off-road dealer for details.

## Severe Duty Use

If your vehicle is used in the following conditions, refer to the *Severe Duty* section of the maintenance schedule.

- Repeated hauling of loads at more than 75% the maximum capacity.
  - The increase workload applied to the drive system accelerates the differentials, gearbox/transmission, and engine oil life. This reduces internal component longevity if not replaced more frequently.
- Driving at excessive speeds for prolonged amount of time.

Higher than the average utility or commercial use requires more frequent fluid and wear component replacement than trail, recreational, or occasional utility purposes.

### *Extreme Cold Condition*

An engine that is frequently operated at or below an ambient temperature of  $-25^{\circ}\text{C}$  ( $-13^{\circ}\text{F}$ ) will require an increase in service and maintenance schedule.

Any combustion engine operated at these low ambient temperature will collect an increased amount of condensation at every startup/warm-up.

Since the engine is not reaching operating temperatures for extended periods of time, the oil is starting to be strongly diluted with water and gas residue (more water content).

An engine needs to reach operating temperature, in order to be able to evaporate condensate out of the oil.

If daily usage (work or leisure driving cycle) is similar to those mentioned below, BRP strongly recommends changing the oil at least once a month.

Parameters of an increase in service and maintenance schedule:

- Engine not reaching the proper operating temperature during normal daily usage
- Multiple starts and stops without reaching operating temperature
- Short idle periods
- Low RPM driving cycle in short distances without reaching operating temperature.

**NOTE:**

BRP strongly recommends the installation of a block heater to help warm up the liquids, this will also help to extend the oil lifetime.

## Deep Mud / Water Use

Whether your vehicle is a X mr model or was accessorized for deep mud / water use, this type of usage requires more frequent maintenance and inspections to ensure debris has not infiltrated mechanical components.

If you regularly ride in deep mud or water, refer to the *Deep Mud / Water* section of the maintenance schedule.

After every ride, be sure to perform the *Post Operation Care for Deep Mud / Water Environment*.

### *Post Operation Care for Deep Mud / Water Environment*

- Rinse the vehicle and its components with fresh water.
- Clean the CVT air filters.
- Drain the CVT compartment and clean if any water or mud is found.
- Inspect and clean engine air filters and engine air filter housing.
- Clean radiator.
- Visually inspect for any water accumulation in the vent hoses (fuel tank, gear-box, front differential and rear final drive). If there is water, bring the vehicle to your nearest authorized Can-Am off-road dealer for inspection and servicing of main components related to the vents.
- Clean front and rear shock absorbers to prevent seal from damage by dust or dirt.
- Clean drive shaft bellows and the propeller shaft yokes or boots.

## Maintenance Schedule

Make sure to perform proper maintenance at recommended intervals as indicated in the tables.

The maintenance chart intervals are based on 3 factors:

- Calendar time
- Vehicle hours
- Odometer reading.

Take in account whichever comes first to determine the maintenance threshold.

Your driving habits determines the factors you shall adhere too. For example:

- Someone who uses their vehicle every other weekend trail riding with friends would most likely follow the **odometer reading** to determine the maintenance interval.
- Someone who uses their vehicle seldomly over the year or only on a few occasions (hunting, camping) would most likely follow the **calendar time** to determine the maintenance interval.
- Someone who uses their vehicle daily / weekly for long periods of time such as agricultural / work would most likely follow the **vehicle hours** to determine the maintenance interval.

**IMPORTANT:** The following tables show the appropriate maintenance application for the first 3 years. For subsequent years, repeat the same pattern alternatively.



### Regular Maintenance Overview

Calendar Years	Vehicle Hours	Odometer	Regular Duty
1	100	3000 km (2000 mi)	A
2	200	6000 km (4000 mi)	A + B
3	300	9000 km (5500 mi)	A

### Severe Duty and Mud/Water Maintenance Overview

Calendar Years	Vehicle Hours	Odometer	Severe Duty and Deep Mud / Water
0.5	100	1500 km (1000 mi)	A+
1	200	3000 km (2000 mi)	A+ / A
1.5	300	4500 km (3000 mi)	A+
2	400	6000 km (4000 mi)	A+ / A / B
2.5	500	7500 km (5700 mi)	A+
3	600	9000 km (5500 mi)	A+ / A

<b>REGULAR DUTY</b>	<b>A</b>	<b>B</b>
<b>A = Adjust</b> <b>C = Clean</b> <b>I = Inspect</b> <b>L = Lubricate</b> <b>R = Replace</b> <b>T = Torque</b>	<b>Every year</b> or <b>100 hours</b> or <b>3000 km</b> (2000 mi)	<b>Every 2 years</b> or <b>200 hours</b> or <b>6000 km</b> (4000 mi)
<b>Air and Fuel Delivery</b>		
Engine air filter	I,C,R	
Fuel tank vent filter	R	
Canister vent pre-filter (CARB and EVAP models)		R
Fuel components and function*		I
Fuel pump pressure		I
<b>Body and Chassis</b>		
Cage fasteners	T	
Seat belts retractors, buckles and semi-cinching	I,C	
<b>Engine and Cooling</b>		
Engine oil and filter	R	
Coolant level and concentration	I,A	
Coolant	<b>R</b> Every 5 years or 12 000 km (8000 mi)	
Spark plugs		R
<b>Exhaust and Emissions</b>		
Exhaust components and function*	I,C	
Spark arrester	C	
<b>Brake</b>		
Brake components and function*	I,C	
Rear wheel scrapers wear plates	I	
Brake fluid	<b>R</b> Every 2 years	
<b>Drive</b>		
Gearbox oil	Replace at first 3000 km (2000 mi) and at 6000 km (4000 mi), then follow the regular schedule	
Gearbox oil	I	R
Drive components and function*	I	
Beadlock screws (if equipped)	T	

<b>REGULAR DUTY</b>	<b>A</b>	<b>B</b>
<b>A = Adjust</b> <b>C = Clean</b> <b>I = Inspect</b> <b>L = Lubricate</b> <b>R = Replace</b> <b>T = Torque</b>	<b>Every year</b> or <b>100 hours</b> or <b>3000 km</b> (2000 mi)	<b>Every 2 years</b> or <b>200 hours</b> or <b>6000 km</b> (4000 mi)
Front differential oil	I	R
<b>Continuously Variable Transmission (CVT)</b>		
CVT components and function*	I,C,L	
<b>Electrical</b>		
Various controls, switches, lights, module updates, fault codes, battery condition*	I	
Vehicle speed sensor (VSS)		C
<b>Steering</b>		
Steering components and function*	I	
<b>Suspension</b>		
Suspension components and function*	I,L,T	

\*For an extensive list of maintenance actions to be performed, refer to your local dealership.

<b>SEVERE DUTY</b>	<b>A+</b>	<b>A</b>	<b>B</b>
<b>A = Adjust</b> <b>C = Clean</b> <b>I = Inspect</b> <b>L = Lubricate</b> <b>R = Replace</b> <b>T = Torque</b>	<b>Every 6 months</b> or <b>100 hours</b> or <b>1500 km (1000 mi)</b>	<b>Every year</b> or <b>200 hours</b> or <b>3000 km (2000 mi)</b>	<b>Every 2 years</b> or <b>400 hours</b> or <b>6000 km (4000 mi)</b>
<b>Air and Fuel Delivery</b>			
Engine air filter	I,C	R	
Fuel tank vent filter		R	
Canister vent pre-filter (CARB and EVAP models)			R
Fuel components and function*			I
Fuel pump pressure			I
<b>Body and Chassis</b>			
Cage fasteners		T	
Seat belts retractors, buckles and semi-cinching		I,C	
<b>Engine and Cooling</b>			
Engine oil and filter	R		
Valve clearance		A (V-twin engines)	A (Mono cyl. engines)
Coolant level and concentration		I,A	
Coolant	R Every 5 years or 12 000 km (8000 mi)		
Spark plugs			R
<b>Exhaust and Emissions</b>			
Exhaust components and function*		I,C	
Spark arrester	C		
<b>Brake</b>			
Brake components and function*		I,C	
Rear wheel scrapers wear plates		I	
Brake fluid	R Every 2 years		
<b>Drive</b>			
Gearbox oil	Replace at first 1500 km (1000 mi) and at 3000 km (2000 mi), then follow the regular schedule		
Gearbox oil		R	

<b>SEVERE DUTY</b>	<b>A+</b>	<b>A</b>	<b>B</b>
<b>A = Adjust</b> <b>C = Clean</b> <b>I = Inspect</b> <b>L = Lubricate</b> <b>R = Replace</b> <b>T = Torque</b>	Every 6 months or 100 hours or 1500 km (1000 mi)	Every year or 200 hours or 3000 km (2000 mi)	Every 2 years or 400 hours or 6000 km (4000 mi)
Drive components and function*		I	
Beadlock screws (if equipped)		T	
Front differential oil		R	
<b>Continuously Variable Transmission (CVT)</b>			
CVT components and function*		I,C,L	
<b>Electrical</b>			
Various controls, switches, lights, module updates, fault codes, battery condition*		I	
Vehicle speed sensor (VSS)			C
<b>Steering</b>			
Steering components and function*		I	
<b>Suspension</b>			
Suspension components and function*		I,L,T	

\*For an extensive list of maintenance actions to be performed, refer to your local dealership.

<b>DEEP MUD / WATER</b>	<b>A+</b>	<b>A</b>	<b>B</b>
<b>A = Adjust</b> <b>C = Clean</b> <b>I = Inspect</b> <b>L = Lubricate</b> <b>R = Replace</b> <b>T = Torque</b>	<b>Every 6 months</b> or <b>100 hours</b> or <b>1500 km (1000 mi)</b>	<b>Every year</b> or <b>200 hours</b> or <b>3000 km (2000 mi)</b>	<b>Every 2 years</b> or <b>400 hours</b> or <b>6000 km (4000 mi)</b>
<b>Air and Fuel Delivery</b>			
Engine air filter	I,C,R		
Fuel tank vent filter		R	
Canister vent pre-filter (CARB and EVAP models)			R
Fuel components and function*			I
Fuel pump pressure			I
<b>Body and Chassis</b>			
Cage fasteners		T	
Seat belts retractors, buckles and semi-cinching		I,C	
<b>Engine and Cooling</b>			
Engine oil and filter	I	R	
Coolant level and concentration		I,A	
Coolant	R Every 5 years or 12 000 km (8000 mi)		
Spark plugs			R
<b>Exhaust and Emissions</b>			
Exhaust components and function*	I,C		
Spark arrester	C		
<b>Brake</b>			
Brake components and function*	I,C		
Rear wheel scrapers wear plates	I		
Brake fluid	R Every 2 years		
<b>Drive</b>			
Gearbox oil	Replace at first 1500 km (1000 mi) and at 3000 km (2000 mi), then follow the regular schedule		
Gearbox oil	I		R
Drive components and function*	I		
Beadlock screws (if equipped)		T	
Front differential oil	I		R

<b>DEEP MUD / WATER</b>	<b>A+</b>	<b>A</b>	<b>B</b>
<b>A = Adjust</b> <b>C = Clean</b> <b>I = Inspect</b> <b>L = Lubricate</b> <b>R = Replace</b> <b>T = Torque</b>	<b>Every 6 months</b> or <b>100 hours</b> or <b>1500 km (1000 mi)</b>	<b>Every year</b> or <b>200 hours</b> or <b>3000 km (2000 mi)</b>	<b>Every 2 years</b> or <b>400 hours</b> or <b>6000 km (4000 mi)</b>
<b>Continuously Variable Transmission (CVT)</b>			
CVT components and function*		I,C,L	
<b>Electrical</b>			
Various controls, switches, lights, module updates, fault codes, battery condition*		I	
Vehicle speed sensor (VSS)			C
<b>Steering</b>			
Steering components and function*	I		
<b>Suspension</b>			
Suspension components and function*	I,L	T	

\*For an extensive list of maintenance actions to be performed, refer to your local dealership.

# MAINTENANCE PROCEDURES

This section includes instructions for basic maintenance procedures.

Due to the complexity of some of the maintenance procedures, good mechanical skills are required. If you are not comfortable with these procedures, do not hesitate to contact an authorized Can-Am off-road dealer, repair shop or person of your own choosing.

## ⚠ WARNING

Unless otherwise indicated, always remove D.E.S.S. key from the D.E.S.S. post before performing any maintenance and remove key.

## ⚠ WARNING

Should removal of a locking device be required (e.g. lock tab, self-locking fastener, etc.), always replace it with a new one.

## Engine Air Filter

### NOTICE

Never modify the air intake system. Otherwise, engine performance degradation or damage can occur. The engine is calibrated to operate specifically with these components.

### Engine Air Filter Replacement Guideline

Engine air filter inspection and replacement frequency should be adjusted according to riding conditions as it is critical to ensure proper engine performance and life span.

Engine air filter inspection and replacement frequency must be increased for the following severe riding conditions:

- Riding on dry sand.
- Riding on dry dirt covered surfaces.

- Riding on dry gravel trails or similar conditions.
- Riding in areas with high concentration of seeds or crop husks.
- Riding in severe snow conditions.

### NOTICE

When riding in dusty conditions or sand, the air box needs to be cleaned before every ride.

### NOTE:

Riding in a group, under these conditions, increases the frequency of the air filter maintenance.

### Engine Air Filter Removal

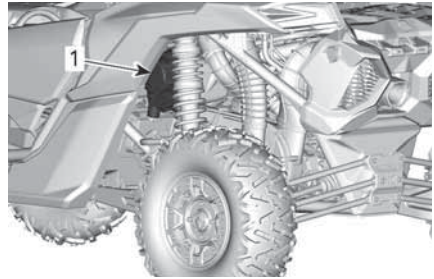

LH REAR OF VEHICLE

1. Air filter housing

Remove the air filter cover by releasing the retaining clamps.



Remove the filter cartridge.

### Engine Air Filter Housing Cleaning

Inspect air filter housing for cleanliness.



**NOTICE**

If sand or other particles are found in air filter housing, clean it using a vacuum cleaner.

**Engine Air Filter Cleaning**

Inspect the filter for any signs of leaks. A streak of dust on the clean side of the filter is a telltale sign. Replace filter if there is any damages. Eliminate any source of air leaks before installing a new filter.

Clean engine air filter by tapping out heavy dust from paper element, this will allow dirt and dust to get out of the paper filter.

**NOTICE**

It is not recommended to blow compressed air on the paper element; this could damage the paper fibers and reduce its filtration ability when used in dusty environments. If engine air filter is too dirty and cannot be cleaned following the recommended procedure, it should be replaced.

Use a clean damp cloth to wipe both the filter sealing surface and the inside of the outlet tube. Ensure that the outlet tube sealing area is undamaged.

Inspect air filter housing for cleanliness.

**Engine Air Filter Installation**

Install air filter cartridge.

Install filter cover with the "TOP" mark upwards (duckbill valve downwards).

Secure cover using the retaining clamps.

**Front Grille Kit**

1. Remove debris from front grille.
2. Clean front grille with water.

**CVT Air Filter**

CVT air filter inspection and cleaning frequency should be adjusted according to riding conditions as it is critical to ensure proper engine performance and life span.

CVT air filter inspection and cleaning frequency must be increased for the following severe riding conditions:

- Riding on dry sand.
- Riding on dry dirt covered surfaces.
- Riding on dry gravel trails or similar conditions.
- Riding in muddy conditions.
- Riding in areas with high concentration of seeds or crop husks.
- Riding in severe snow conditions.

**NOTE:**

Riding in a group, under these conditions, increases the frequency of the air filter maintenance.

**CVT Air Filter Removal**

Open the air box cover.

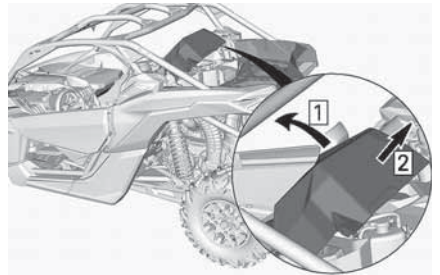

Remove CVT filter from vehicle.

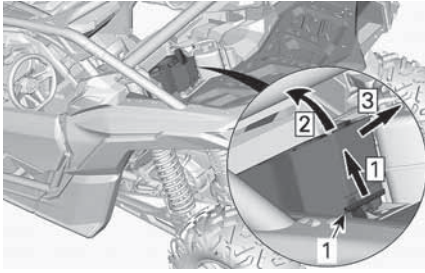

1. CVT air filter

1. Unlatch
2. Lift the rear part
3. Pull off

### CVT Air Filter Inspection and Cleaning

Inspect filter and replace if necessary.

Remove CVT filter. Refer to *CVT Filter Removal* and clean it using soft soap and water then rinse with water.

Gently shake off excess water and allow filter to dry at room temperature.

### CVT Air Filter Installation

Reinstall filter:

- Insert the three tabs at front of the filter in the corresponding slots
- Securely latch the filter.

Reinstall the air box cover. Make sure it is properly secured.

### Evaporative Emission System Pre-Filter (If Equipped)

#### Evaporative Emission System Pre-Filter Replacement

1. Remove the protective plate.

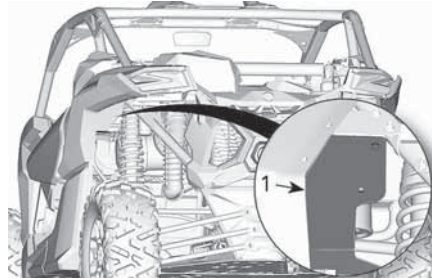

1. Protective plate
2. Remove the hose clamps.

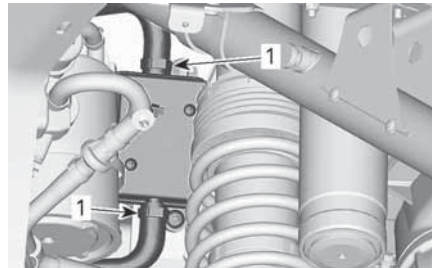

1. Hose clamps
3. Remove the retaining screw.
4. Remove the pre-filter assembly.

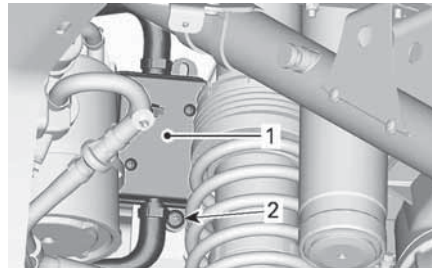

1. Filter
2. Retaining screw
5. Install a new pre-filter assembly. Secure the hoses using clamps.

<b>Tightening Torque</b>	
Pre-filter retaining screw	2.5 ± 0.5 Nm (22 ± 4 lbf-in)

6. Reinstall the protective plate.

Tightening Torque	
Protective plate retaining screw	6.5 ± 0.5 Nm (58 ± 4 lbf-in)

## Engine Oil

### Engine Oil Level Verification

#### NOTICE

**Operating the engine with an improper level may severely damage engine.**

With the engine at normal operating temperature, place vehicle on a level surface and check the oil level as follows:

1. Start engine and let it idle for at least 20 seconds.
2. Stop engine.
3. Unscrew dipstick then remove it and wipe clean.

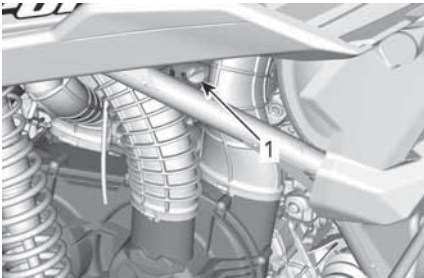

LH REAR OF VEHICLE

1. Dipstick
4. Reinstall dipstick, screw it in completely.
5. Remove dipstick and check oil level. It should be near or equal to the upper mark.



#### TYPICAL

1. MIN
2. MAX
3. Operating range

To add oil, remove the dipstick. Place a funnel into the dipstick tube.

Add a small amount of recommended oil and recheck oil level.

Repeat the above procedures until oil level reaches the dipstick's upper mark.

#### NOTE:

Do not overfill. Wipe off any spillage.

Properly tighten dipstick.

#### Recommended Engine Oil

Rotax® engines were developed and validated using the XPS™ oil. BRP recommends the use of its XPS engine oil or an equivalent at all time. Damages caused by the use of an oil not suitable for the engine may not be covered by the BRP Limited Warranty.

XPS Recommended Engine Oil	
General purpose	5W40 Synthetic blend oil
Cold temperature	0W40 Synthetic oil
Warm temperature	10W50 Synthetic oil

<b>XPS Recommended Engine Oil</b>
If the Recommended XPS Engine Oil is Not Available
<p>Use a 5W40 or 10W50 4-stroke SAE engine oil meeting or exceeding the following lubricant industry specifications. Always check the API service label certification on the oil container, it must contain at least one of the indicated standards.</p> <ul style="list-style-type: none"> <li>- API service classification SJ, SL, SM or SN</li> </ul>

**Engine Oil Change**

<b>⚠ CAUTION</b>
<b>The engine oil can be very hot. Wait until engine oil is warm.</b>

<b>NOTICE</b>
<b>Engine oil and oil filter must be replaced at the same time.</b>

Bring engine to its normal operating temperature.

Place vehicle on a level surface.

Remove dipstick.

Place a drain pan under the engine drain plug area.

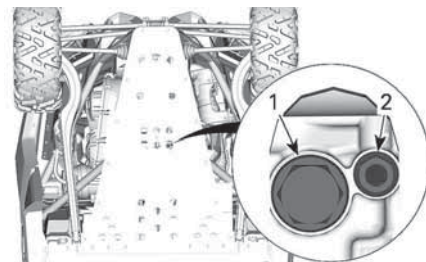

**UNDERNEATH REAR OF VEHICLE**

1. Magnetic drain plug
2. Secondary drain plug

Clean the drain plugs area.

**NOTE:**  
A funnel can be used between the drain holes and the skid plate to avoid spillage.

Unscrew drain plugs and discard the gasket rings.

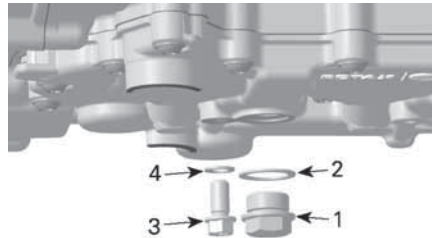

1. Magnetic drain plug
2. Gasket ring
3. Secondary drain plug
4. Gasket ring

Allow oil to drain completely from the crankcase.

Clean the magnetic drain plug from metal shavings and residue. Presence of debris gives an indication of internal engine damage.

Install a **NEW** gasket ring on the drain plug.

<b>NOTICE</b>
<b>Never use the gasket ring a second time. Always replace by a new one.</b>

Install and tighten drain plug to the recommended specification.

<b>Tightening Torque</b>	
Secondary drain plug	15 ± 2 Nm (133 ± 18 lbf-in)
Magnetic drain plug	30 ± 3 Nm (22 ± 2 lbf-ft)

Replace oil filter. Refer to *Oil Filter*.

Refill engine with recommended engine oil.

Check oil level, refer to *Engine Oil Level Verification*.

Engine Oil Capacity	
Engine oil and engine oil filter replacement	3.5 l (3.7 qt(liq.,US))

## Oil Filter

### Oil Filter Access

Access the oil filter by the RH rear of the vehicle.

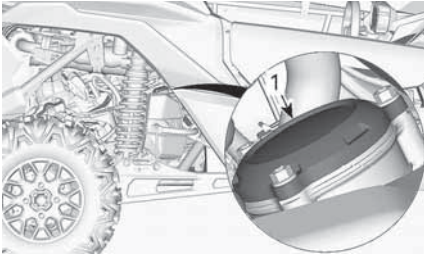

1. Oil filter cover

### Oil Filter Removal

Clean oil filter area.

Remove oil filter cover.

Remove oil filter.

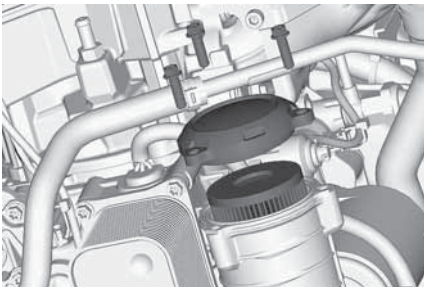

### Oil Filter Installation

Check and clean the oil filter inlet and outlet area for dirt and other contaminations.

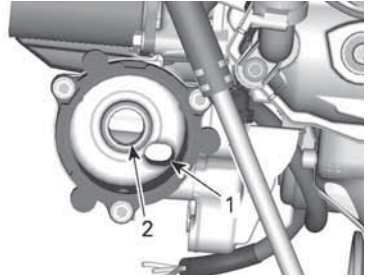

1. Outlet to the engine oil providing system
2. Inlet from the oil pump to the oil filter

Install a **NEW** O-ring on oil filter cover.

Install the new filter into the cover.

Apply engine oil on O-ring and filter seal.

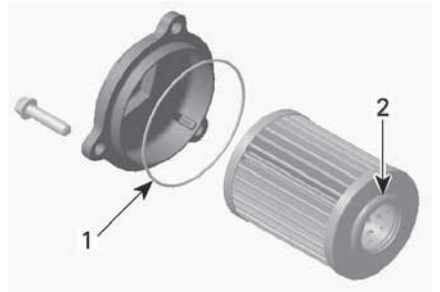

1. Slightly oil
2. Slightly oil

### NOTICE

**Pay attention to avoid pinching the O-ring during filter and cover installation.**

Install the cover on the engine.

Tighten oil filter cover screws to recommended specification.

### Tightening Torque

Oil filter cover screws	10 ± 1 Nm (89 ± 9 lbf-in)
-------------------------	------------------------------

## Radiator

### Radiator Inspection and Cleaning

To access the radiator, remove the front service cover.

#### **CAUTION**

Wait for the radiator to cool down before proceeding.

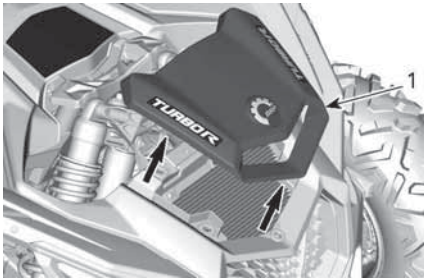

FASCIA COVER

#### **NOTICE**

Do not attempt to remove the lower grilles

Inspect radiator and hoses for leaks or any damage.

Inspect radiating fins. They must be clean, free of mud, dirt, leaves and any other deposit that would prevent the radiator to cool properly.

If available, use a garden hose to rinse the radiating fins.

#### **CAUTION**

Never clean radiator with your hands when it is hot. Let the radiator cool down before cleaning.

#### **NOTICE**

Be careful not to damage the radiating fins when cleaning. Do not use any object/tool that could damage the fins. When hosing, use low pressure only. Never use a HIGH PRESSURE washer.

Reinstall the fascia cover and grille.

## Engine Coolant

### Engine Coolant Level Verification

#### **WARNING**

Check coolant level with engine cold.

1. Place vehicle on a level surface.
2. Remove service cover by unlatching the rear lifting it upwards.



LIFTING REAR OF SERVICE COVER

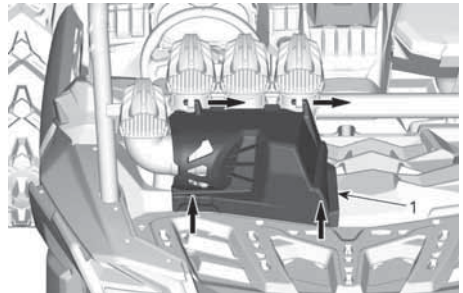

3. Remove pressure cap.

**⚠ WARNING**

In order to avoid potential burns, do not remove the pressure cap or loosen the coolant drain plug if the engine is hot.

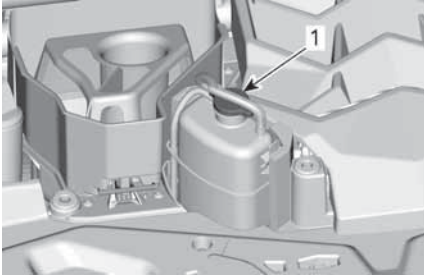

1. Pressure cap

4. Ensure cooling system is full up to the MAX line.



5. Add coolant in system as necessary. Use a funnel to avoid spillage. **Do not overfill.**

6. Reinstall pressure cap on cooling tank.

**NOTE:**

Coolant level can be checked by looking at the side of the coolant reservoir.

**Recommended Engine Coolant**

**XPS Recommended Coolant**

Extended life pre-mixed coolant

**Alternative, or if XPS is not available**

Distilled water and antifreeze solution (50% distilled water, 50% antifreeze)

**NOTICE**

Always use ethylene-glycol anti-freeze containing corrosion inhibitors specifically for internal combustion aluminum engines.

**Engine Coolant Replacement**

**Cooling System Draining**

**⚠ WARNING**

In order to avoid potential burns, do not remove the pressure cap or loosen the coolant drain plug if the engine is hot.

Lift the rear of the vehicle approximately 30 cm (12 in).

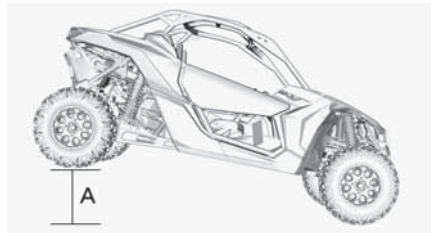

A. 30 cm (12 in)

Place a drain pan under the lower hose of the radiator.

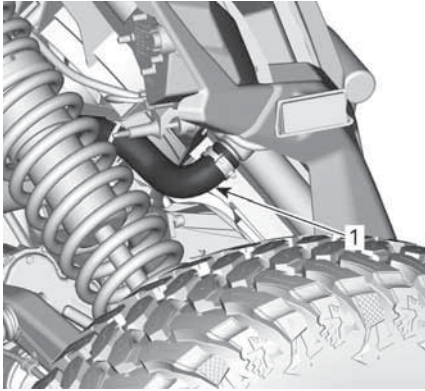

1. Lower hose

Install a large hose pincher on the lower hose of the radiator.

Slowly detach hose from radiator.

Remove coolant reservoir pressure cap.

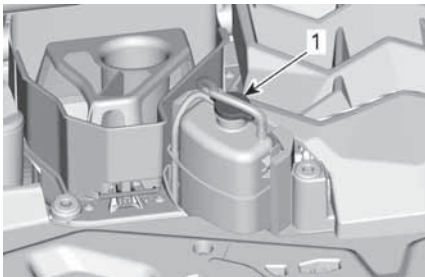

1. Pressure cap

Wait until the coolant flow stops or decreases.

Remove the hose pincher to drain the rest of the coolant.

Install radiator hose clamp.

Tightening Torque	
Radiator hose clamp	2.5 to 3.5 Nm (22 to 31 lbf-in)

Fill cooling system with coolant, refer to *Cooling System Refilling and Bleeding* procedure.

## Cooling System Refilling and Bleeding

1. Remove the pressure cap.

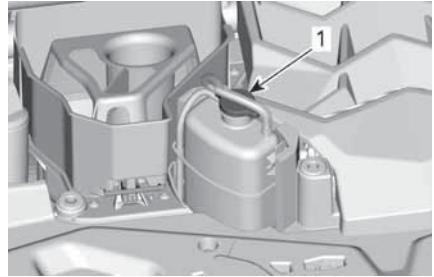

1. Pressure cap

2. Fill the cooling system until level reaches the MAX line on the coolant reservoir.



3. Install pressure cap.

4. Run engine at idle with the pressure cap **on** until the cooling fan cycles 2 times.

5. Depress throttle pedal two or three times.

6. Stop engine and let it cool down.

Add coolant if necessary.

### **⚠ WARNING**

**In order to avoid potential burns, do not remove the pressure cap or loosen the coolant drain plug if the engine is hot.**

7. After the next ride following this procedure, check coolant level. Add coolant as required. Refer to *Engine Coolant Level Verification*.



## Muffler and Spark Arrester

### Muffler Spark Arrestor Cleaning

The mufflers must be periodically purged of accumulated carbon.

#### **CAUTION**

**Never perform this operation immediately after the engine has been running as exhaust system is very hot.**

Remove retaining screws securing muffler cover in place and remove muffler cover.

Pull out spark arrester and remove carbon deposits using a brush.

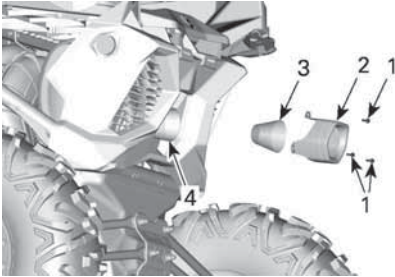

1. Retaining screws
2. Muffler cover
3. Spark arrester

#### **NOTICE**

**Use a metallic soft brush and be careful to avoid damaging spark arrester mesh.**

Inspect mesh of spark arrester for any damage. Replace as needed.

Inspect spark arrester chamber in muffler. Remove any debris as needed.

Reinstall the spark arrester in the reverse of the removal procedure. Tighten retaining screws to specification.

#### Tightening Torque

Muffler cover screws	10 ± 2 Nm (89 ± 18 lbf-in)
----------------------	-------------------------------

## Front Differential

### Front Differential Oil Level Verification

Clean filler plug prior to check oil level.

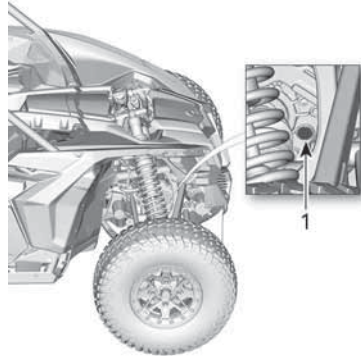

1. Filler plug

With vehicle on a level surface, check oil level by removing filler plug. Oil level must reach the lower edge.

#### Tightening Torque

Filler plug	16.25 ± 2.75 Nm (144 ± 24 lbf-in)
-------------	--------------------------------------

### Recommended Front Differential Oil

<b>XPS Recommended Front Differential Oil</b>
75W90 Synthetic gear oil
<b>Alternative if XPS Product is not Available</b>
75W90 (API GL-5) synthetic gear oil

The XPS oil is specially formulated to meet the lubrication requirements of this differential. BRP strongly recommends the use of its XPS oil.

**NOTICE**

**Do not use another type of oil when servicing.**

**Front Differential Oil Change**

Place vehicle on a level surface. Set the gearbox to PARK.

From underneath of vehicle, clean drain plug area.

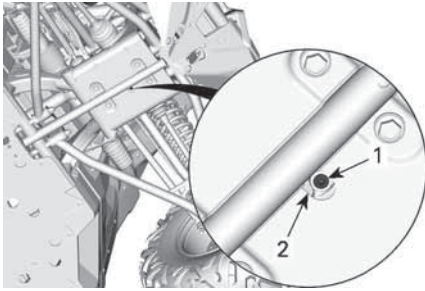

**UNDERNEATH THE VEHICLE**

- 1. Drain plug
- 2. Access hole

Place a drain pan under the front differential.

Access the drain plug through the hole in the skid plate.

Remove drain plug.

Unscrew filler plug.

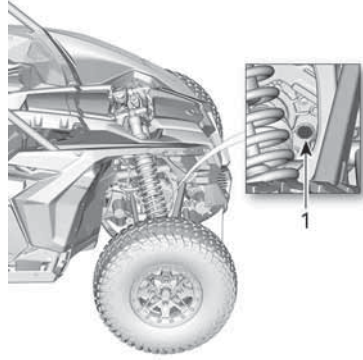

1. Filler plug

Install drain plug.

Tightening Torque	
Drain plug	2.75 ± .25 Nm (24 ± 2 lbf-in)

Refill front differential with recommended oil.

Tightening Torque	
Filler plug	16.25 ± 2.75 Nm (144 ± 24 lbf-in)

**Gearbox**

**Gearbox Oil Level Verification**

Place the vehicle on a level surface. Select PARK position.

Check the gearbox oil level by removing the gearbox oil level plug located at the rear of vehicle, on the RH side.

**NOTICE**

**Pay attention not to lose the oil level plug O-ring.**

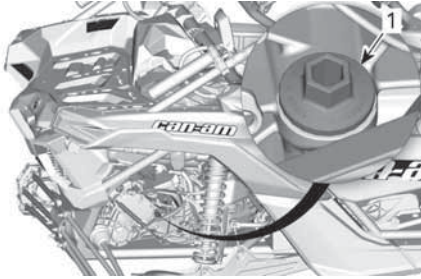

1. Gearbox oil level plug

Reinstall the plug, screw it in completely.

Remove plug again and check oil level on the dipstick. It should be near or equal to the upper mark.



- 1. MIN.
- 2. MAX.
- 3. Operating range

To add oil, place a funnel into the oil level plug hole.

Add a small amount of recommended oil and recheck oil level.

Repeat the above procedures until oil level reaches the dipstick's upper mark.

**NOTE:**  
Do not overfill. Wipe off any spillage.

**NOTICE**

**Operating the gearbox with an improper oil level may severely damage gearbox.**

Properly tighten the plug.

**Tightening Torque**

Gearbox oil level plug	5 ± 0.6 Nm (44 ± 5 lbf-in)
------------------------	-------------------------------

**Recommended Gearbox Oil**

**XPS Recommended Gearbox Oil**

75W140 Synthetic gear oil

**Alternative, or if not available**

75W 140 API GL-5 Synthetic gear oil

**NOTE:**

The XPS oil is specially formulated to meet the lubrication requirements of this gearbox. BRP strongly recommends the use of its XPS oil. However, if the XPS synthetic gear oil is not available, use the following lubricant:

**NOTICE**

**Do not use another type of oil when servicing.**

**Gearbox Oil Change**

Oil change should be done with a warm engine.

**CAUTION**

**The gearbox oil can be very hot.**

Place the vehicle on a level surface.

Clean drain plug area.

Clean the oil level plug area.

Under the vehicle, place a drain pan underneath the magnetic drain plug area.

Remove the gearbox oil level plug (dipstick).

**NOTICE**

**Pay attention not to lose the oil level plug O-ring.**

Remove the magnetic gearbox drain plug and discard sealing ring.

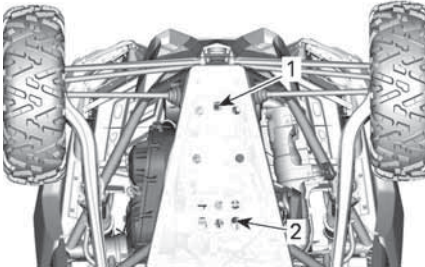

1. Gearbox drain plug
2. Engine oil drain plug

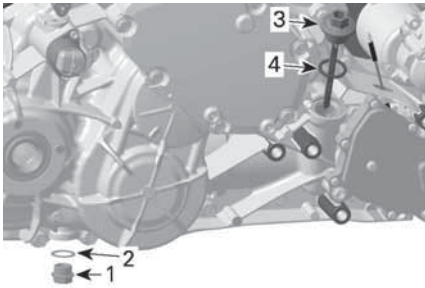

1. Magnetic drain plug
2. Sealing ring (discard)
3. Gearbox oil level plug (dipstick)
4. O-ring

Let oil completely drain from gearbox.

Install the drain plug.

**NOTE:**

Clean drain plug from any metallic particles prior to installation.

Reinstall magnetic drain plug.

Always install a **NEW** sealing ring.

**Tightening Torque**

Magnetic drain plug	30 ± 3 Nm (22 ± 2 lbf-ft)
---------------------	------------------------------

Refill gearbox.

**NOTICE**

**Use ONLY the recommended type of oil.**

Check oil level, refer to *Gearbox Oil Level Verification*.

Dispose gearbox oil as per your local environmental regulations.

**Spark Plugs**

**Access to Spark Plugs (Models without Intercooler)**

Remove the air inlet cover and the grille.

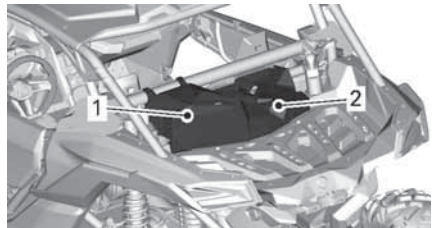

1. Air inlet cover
2. Grille

Remove the protective plate rear retaining screws.

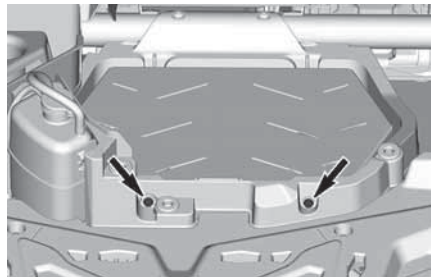

Remove the service cover.

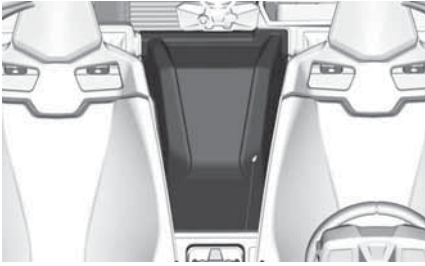

Remove the protective plate front retaining screws.

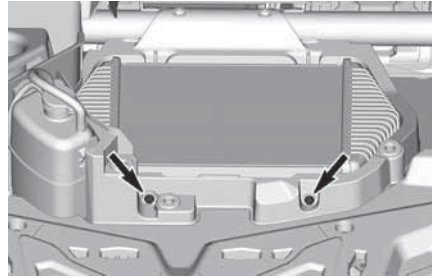

Remove the service cover.

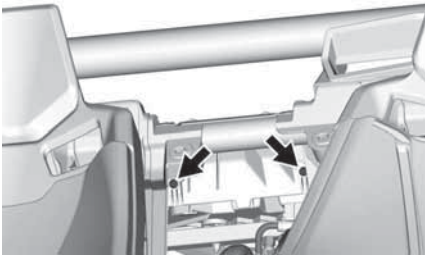

Remove the protective plate.

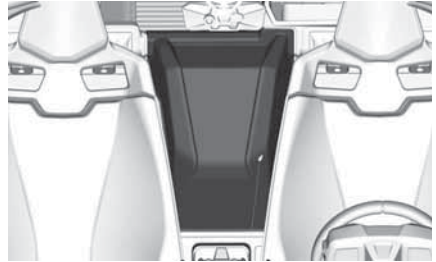

Remove the intercooler front retaining screws.

**Access to Spark Plugs (Models with Intercooler)**

Remove the air inlet cover and the grille.

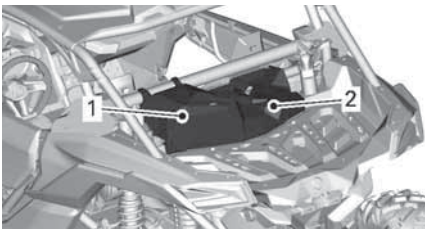

1. Service cover
2. Grille

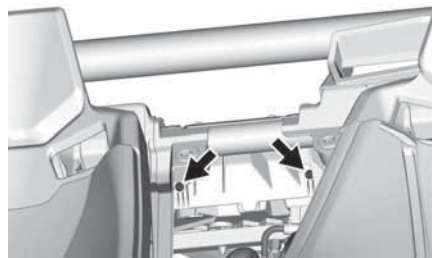

Disconnect intercooler hose.

Remove the intercooler rear retaining screws.

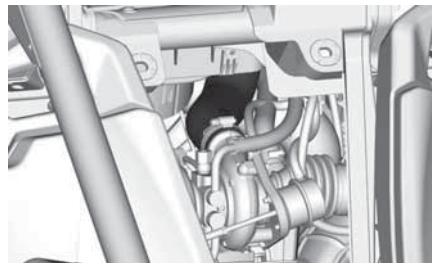

Open intercooler and crankcase hose support by removing the screw.

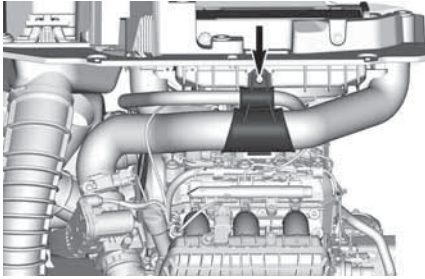

Lift intercooler assembly.

Disconnect the intercooler fan connector.

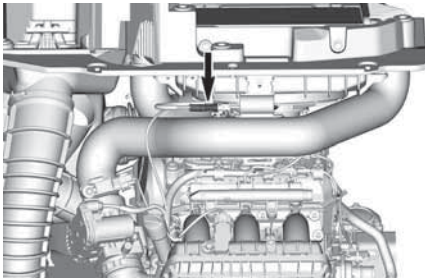

Move intercooler assembly aside

### Spark Plug Removal (All Models)

1. Disconnect CAPS (camshaft position sensor).

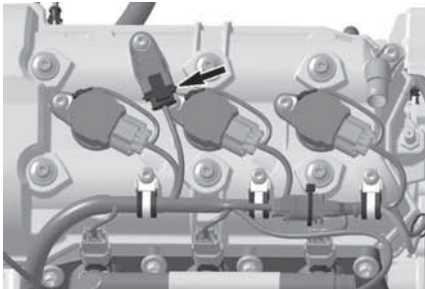

2. Remove:
  - Ignition coil retaining screws
  - Ground connector.
3. Disconnect ignition coil

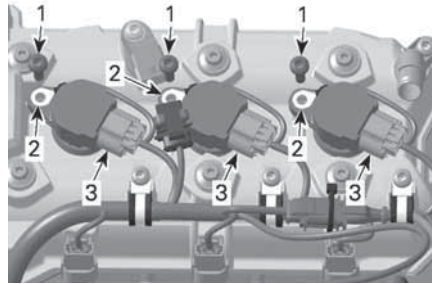

1. Retaining screws
2. Ground connectors
3. Ignition coil connectors

### NOTICE

**Do not pry on ignition coil with a tool.**

4. Remove ignition coils with gaskets from spark plug by rotating coil side to side as you pull up.
5. Clean spark plug and cylinder head with pressurized air.

### CAUTION

**Always wear safety goggles when using pressurized air.**

6. Unscrew the spark plugs completely using a spark plug socket.
7. Use ignition coil as a puller.

### Spark Plug Installation

Prior to installation make sure that contact surface of cylinder head and spark plug is free of grime.

Using a feeler gauge, set the spark plug gap.

### Spark Plug Gap

0.7 to 0.8 mm (.028 to .031 in)

Screw spark plug into cylinder heads by hand and tighten to specification using a torque wrench.

**⚠ CAUTION**

**Do not overtighten spark plugs, engine damage can occur.**

**Tightening Torque**

Spark plug	11 Nm (97 lbf-in)
------------	-------------------

Install the ignition coil on the spark plug.

Align the retaining screw hole of the ignition coil with the threaded hole on the valve cover.

Push the ignition coil all the way down until it rests on the valve cover.

Install and tighten retaining screw.

**Tightening Torque**

Ignition coil retaining screw	9 ± 1 Nm (80 ± 9 lbf-in)
-------------------------------	-----------------------------

Reinstall all other removed parts using the reverse of removal procedure.

**NOTE:**

Make sure to reconnect the inter-cooler fan connector (if equipped).

**Tightening Torque**

Protective plate retaining screws (models without intercooler)	8 ± 1 Nm (71 ± 9 lbf-in)
Intercooler retaining screws (if equipped)	

**CVT Cover**

For a better understanding, some illustrations are taken with engine out of vehicle. To perform the following

instructions, it is not necessary to remove engine.

**⚠ WARNING**

**Never touch CVT while engine is running.  
Never drive vehicle when CVT cover is removed.**

**⚠ CAUTION**

**Engine must be cool before cover is removed.**

**NOTICE**

**This CVT is lubrication free.  
Never lubricate any components except drive pulley bearing.**

**CVT Cover Access**

CVT cover can be accessed from the LH side at the rear of vehicle.

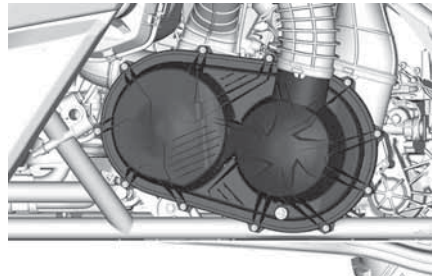

*PARTS REMOVED FOR CLARITY*

**CVT Cover Removal**

**NOTE:** The following procedure is the same for Turbo engines and Turbo RR engines.

Loosen CVT inlet hose clamp(s).

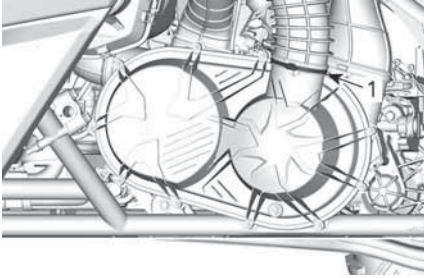

1. Clamp

Remove all CVT cover retaining screws.

Remove the center top screw last to support the cover during removal.

**NOTE:**

Do not use an impact tool to remove CVT cover screws.

Remove the CVT cover and its gasket.

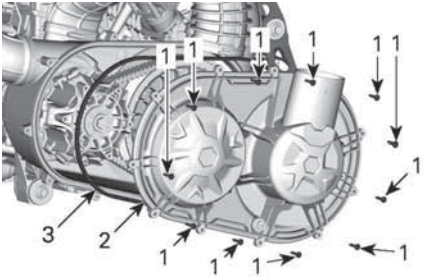

**TURBO ENGINE SHOWN**

1. CVT cover screws
2. CVT cover
3. Gasket

Check inside front and rear CVT outlet hoses to make sure there are no debris.

**CVT Cover Installation**

Install the center top screw first.

Tighten the CVT cover screws as per following sequence.

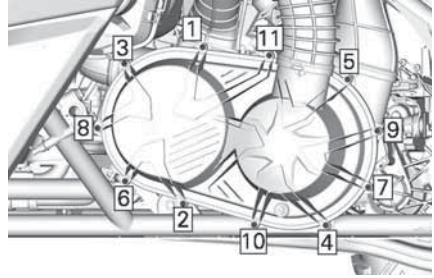

Tightening Torque	
CVT Cover screws	7 ± 0.8 Nm (62 ± 7 lbf-in)

**Drive Belt**

**Drive Belt Removal**



**NOTE:** The following procedure is the same for Turbo engines and Turbo RR engines.

NOTICE
In case of a drive belt failure, the CVT, cover and air outlet must be cleaned.

Please refer to *Tips for Maximizing Drive Belt Durability* in *Basic Procedures* for some IMPORTANT information.

Remove the CVT Cover.

Open the driven pulley.

Required Tools	
Puller/locking tool 529 000 088	
Driven pulley adaptor 708 200 720	

Insert the pulley adaptor in the driven pulley threaded hole, then screw it in.



Insert the puller/locking tool in the pulley adaptor threaded hole, then screw it in to open the pulley.

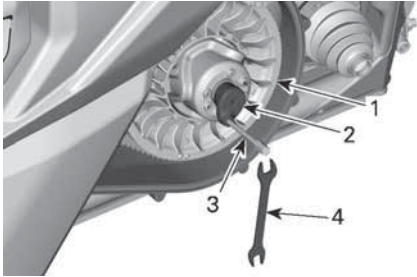

1. Fixed sheave of driven pulley
2. Adaptor (in glove box)
3. Puller/locking tool (in tool kit)
4. Wrench (in tool kit)

To remove belt, slip the belt over the top edge of fixed sheave, as shown.

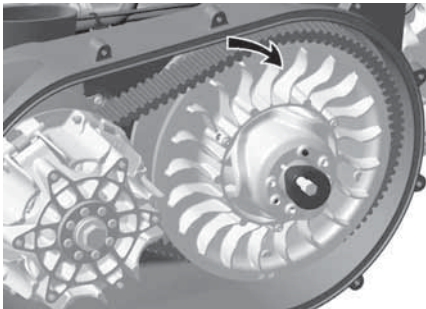

**TURBO ENGINE SHOWN**

**Drive Belt Installation**

For installation, reverse the removal procedure. Pay attention to following details.

The maximum drive belt life span is obtained when the drive belt has the proper rotation direction. Install it so that the arrow printed on belt is pointing towards front of the vehicle, viewed from top.

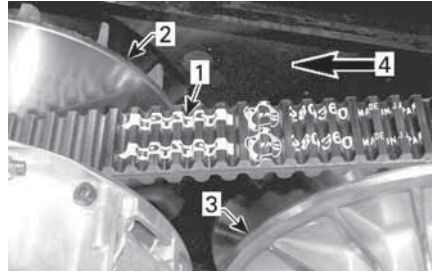

1. Arrow printed on belt
2. Drive pulley (front)
3. Driven pulley (rear)
4. Rotation direction

Turn the driven pulley until the lowest portion of the cogs on the external surface of the drive belt is even with the driven pulley edge.

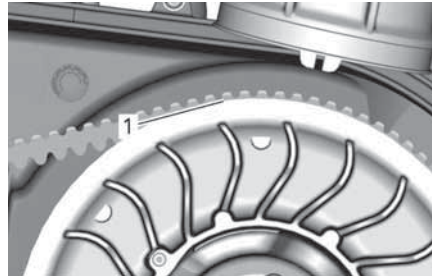

1. Lowest portion of cogs even with driven pulley edge

**Drive and Driven Pulleys**

**Drive and Driven Pulleys Inspection**

This inspection must be performed by an authorized Can-Am dealer, repair shop, or person of your own choosing for maintenance, repair, or replacement.

**Drive Pulley**

**All models except Turbo RR**

Inspect the bushings of the sliding sheave, O-ring and sliding shoes of the drive pulley, replace worn parts.

**Turbo RR**

Inspect the bushings of the sliding sheave and all rollers of the drive pulley, replace worn parts.

### Driven Pulley

Inspect the bushings of the cam and of the sliding sheave of the driven pulley, replace worn parts.

## Battery

### Battery Maintenance

#### NOTICE

**Never charge a battery while installed in vehicle.**

These vehicles are equipped with a VRLA battery (Valve Regulated Lead Acid). It is a maintenance-free type battery, there is no need to add water to adjust electrolyte level.

#### NOTICE

**Never remove the battery sealing cap.**

### Battery Access

To access the battery, move the passenger seat completely forward, refer to *Seat in Equipment*.

### Battery Removal

Disconnect BLACK (-) cable first then RED (+) cable.

#### NOTICE

**Always respect this order for disassembly; disconnect BLACK (-) cable first.**

Remove battery holder retaining screws.

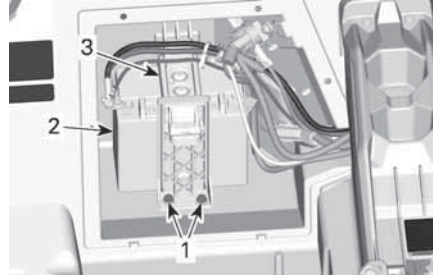

1. Battery holder retaining screws
2. Battery
3. Battery holder

Remove battery holder.

Remove battery.

### Battery Cleaning

Clean battery, battery casing and battery posts using a solution of baking soda and water.

Remove corrosion from battery cable terminals and battery posts using a firm wire brush. Battery casing should be cleaned by soft brush and baking soda solution.

### Battery Installation

Battery installation is the reverse of the removal procedure, however, pay attention to the following.

#### NOTICE

**Reversed battery polarity will damage the voltage regulator.**

#### NOTICE

**Always connect RED (+) cable first then BLACK (-) cable.**

## Fuses

### Fuse Replacement

If a fuse is burnt, replace it by one of the same rating.

**NOTICE**

**Do not use a higher rated fuse as this can cause severe damage.**

**Fuses and Fusible Links**

**Front Fuse Box and Dynamic Power Steering (DPS) Fuse**

To access the front fuse box or the DPS fuse, remove the front service cover.

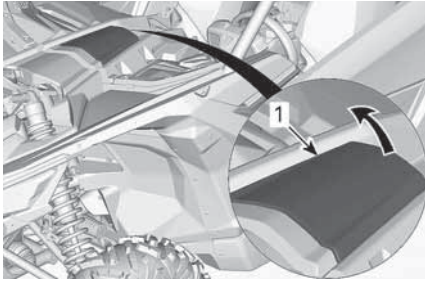

1. Front service cover

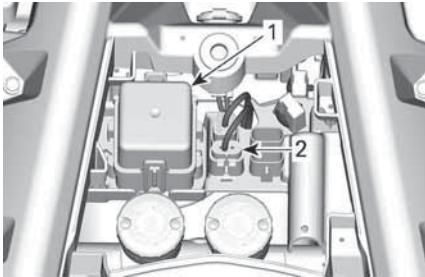

1. Front fuse box  
2. DPS fuse

**Rear Fuse Box**

To access the rear fuse box, remove the driver seat. Refer to *Seats in Equipment*.



1. Driver seat

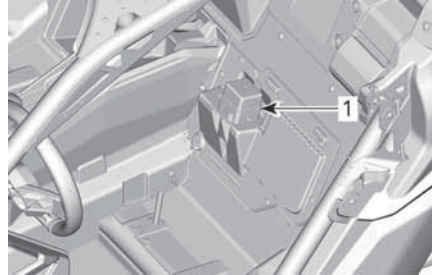

1. Rear fuse box

**Fusible Links**

The fusible links are on the starter solenoid harness.

In the event that a fusible link blows, see a Can-Am SSV dealer, a repair shop or the person of your choosing.

**Fuse Box Description**

Regulator Fuse Holder		
No	DESCRIPTION	RATING
-	Regulator	50 A

**NOTE:**  
Regulator fuse holder is located near battery.

DPS Fuse Holder		
No	DESCRIPTION	RATING
-	Dynamic power steering (DPS)	40 A

Fusible Links		
No	DESCRIPTION	RATING
1	Main	16 AWG
2	Accessories	16 AWG

Front Fuse Box		
No	DESCRIPTION	RATING
F7	4WD actuator	10 A
F11	Lights	20 A
F12	DC Outlet Connector DC3	20 A
F14	Accessories	30 A
F16	Taillights	10 A
F22	Smart-Shox (only for Turbo RR models)	20 A
F23	Smart-Lok	20 A
R3	Accessories Engine Control Module (ECM)	-
R4	Head lamp relay (only for Turbo RR models)	-
R8	Brake Relay	-

Rear Fuse Box		
No	DESCRIPTION	RATING
F4	Gauge Relay	10 A
F5	Ignition Fuel injectors Fuel pump	10 A
F6	Engine Control Module (ECM)	10 A

Rear Fuse Box		
No	DESCRIPTION	RATING
F8	Start switch Clock	10 A
F9	Cooling fan	25 A
F17	Intercooler fan	25 A
F18	EVAP/Oxygen Sensor	10 A
R1	Cooling fan	-
R2	Main	-
R10	Intercooler fan	-

**NOTE:**  
Fuses are identified on the fuse box cover.

### Lights

Always check light operation after replacement.

The headlights and taillights are LEDs (Light Emitting Diode). This technology has proven itself on the reliability.

**NOTE:**  
Headlight or taillight internal LEDs can not be replaced. In case of a malfunction, the headlight or taillight assembly must be replaced.

In the unlikely event they do not work, have them checked by an authorized Can-Am SSV dealer, repair shop or person of your choosing.

### Drive Shaft Boot

#### *Drive Shaft Boot Inspection*

Visually inspect drive shaft boots conditions.

Check boots for cracks, tears, leaking grease, etc.

Repair or replace damaged parts as necessary.

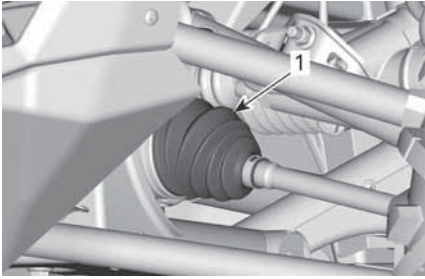

**FRONT OF VEHICLE**  
1. Inner drive shaft boot

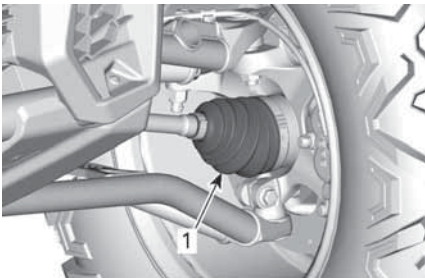

**FRONT OF VEHICLE**  
1. Outer drive shaft boot

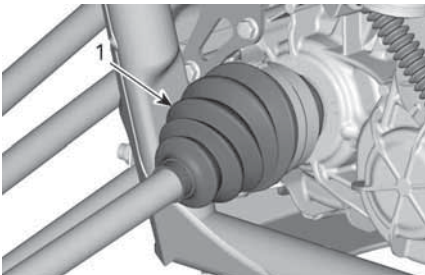

**REAR OF VEHICLE (COMPONENTS REMOVED FOR CLARITY)**  
1. Inner drive shaft boot

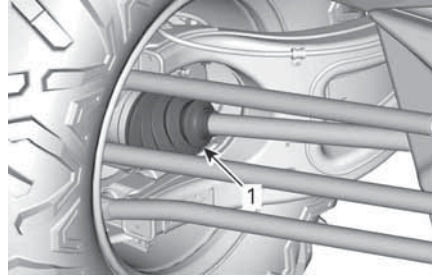

**REAR OF VEHICLE**  
1. Outer drive shaft boot

## Wheel Bearing

### Wheel Bearing Inspection

Lift and support vehicle. Refer to *Lifting and Supporting the Vehicle*.

Push and pull the wheels from the upper edge to feel the play.

See an authorized Can-Am dealer, a repair shop or person of your choosing if there is abnormal play.



TYPICAL

## Wheels and Tires

### Wheel Removal

Loosen nuts then lift and support vehicle. Refer to *Lifting and Supporting Vehicle*.

Remove lug nuts then remove wheel.

### Wheel Installation

If tires are unidirectional, their rotation must be kept in a specific direction.

Unidirectional tires have inscriptions on the sidewall.



TYPICAL

1. Direction of rotation

Tighten wheel lug nuts to the specified torque using the illustrated sequence.

**NOTE:**

Do not use any type of lubricant on the lug nuts threads before tightening.

Tightening Torque	
Wheel lug nuts	120 ± 5 Nm (89 ± 4 lbf-ft)



**NOTICE**

Always use the recommended wheel lug nuts for the type of wheel. Using a different lug nut could cause damages to the rim or studs.

**Tire Pressure**

**⚠ WARNING**

Tire pressure greatly affects vehicle handling and stability. Insufficient pressure may cause tire to deflate and rotate on wheel. Overpressure may burst the tire. Always follow recommended pressure. **NEVER** set tire pressure below minimum. It could cause the tire to dislodge from the rim.

Check pressure when tires are cold before using the vehicle. Tire pressure changes with temperature and altitude. Recheck pressure if one of these conditions has changed.

Refer to the *Tires Pressure and Maximum Load Label* on your vehicle for applicable pressure.

**NOTE:**

Although the tires are specifically designed for off-road use, a flat may still occur. Therefore, it is recommended to carry a tire gauge, tire pump and a repair kit.

**Tire Inspection**

Check tire for damage and wear. Replace if necessary.

**⚠ WARNING**

Do not rotate tires. The front and rear tires have a different size. The left and right tires have different unidirectional tread patterns.

**Tire Replacement**

Tire replacement should be performed by an authorized Can-Am Off-road dealer, a repair shop or a person of your choosing.

**⚠ WARNING**

Replace tires only with the same type and size as original tires. For unidirectional tread pattern, ensure that the tires are installed in the correct direction of rotation. Tires should be replaced, by an experienced person, in accordance with tire industry standards and tools.

**Tire Mounting on Beadlock Wheels**

1. Mount the tire on wheel.
  1. On the opposite side of beadlock, apply tire mounting lube on inner bead of tire and wheel to ensure proper seat when inflating. Mount the inner bead over the wheel.
  2. Seat tire outer bead in the shoulder of the beadlock inner ring and center the tire.



**TYPICAL – TIRE OUTER BEAD**

1. Tire outer bead
  2. Beadlock inner ring shoulder
2. Install all beadlock screws. To avoid cross threading, start all screws by hand.

**NOTICE**

Do not use an impact wrench for installing beadlock screws. The risk of screw breaking or screw stripping is high when using an impact wrench.

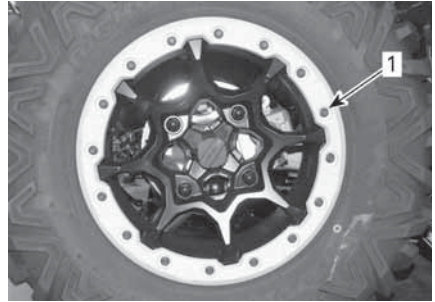

1. Beadlock to be manually tightened
3. Tighten beadlock screws as per following specification and sequence.

**NOTE:**

To ensure even pressure on the beadlock clamp ring, tighten screws **a few turns at a time**.

Tightening Torque	
Beadlock screws (FIRST TORQUE)	14 ± 1 Nm (124 ± 9 lbf-in)

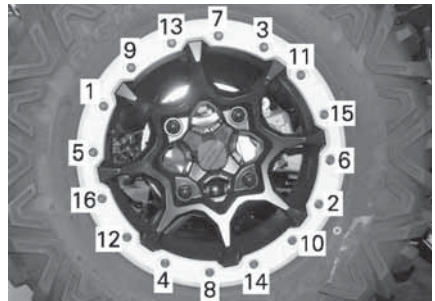

**TYPICAL - TIGHTENING SEQUENCE**

4. At this time check if the tire is still centered on wheel. Reposition it if necessary.
5. Tighten beadlock screws as per the **second** torque using the same sequence.

Tightening Torque	
Beadlock screws (SECOND TORQUE)	25 ± 1 Nm (18 ± 1 lbf-ft)



TYPICAL - TIGHTENING SEQUENCE

**NOTE:**

The beadlock clamp ring should be in contact with the beadlock inner ring. The beadlock clamp ring can flex slightly to match the tire bead. IT IS NORMAL.

- Verify the gap between tire and beadlock clamp ring, it should be practically equal all around the ring.

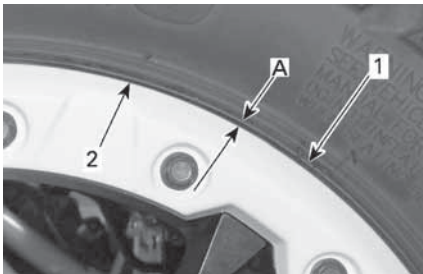

- Tire
  - Beadlock clamp ring edge
- Gap equal all around beadlock clamp ring  
If the gap is not acceptable,
    - Loosen all screws.
    - Check tire position on wheel and reposition it if necessary.

- Restart the torquing sequence as detailed.
- Torque beadlock screws a **final** time following the indicated sequence.

Tightening Torque	
Beadlock screws (FINAL TORQUE)	25 ± 1 Nm (18 ± 1 lbf-ft)

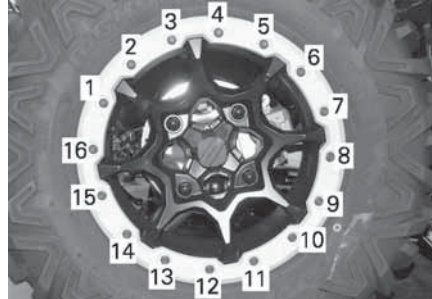

TYPICAL - FINAL TIGHTENING SEQUENCE

- Inflate tire to seat the inner bead on wheel. Always use safe practices, such as a tire safety cage.

<b>⚠ WARNING</b>
<b>Never exceed tire's recommended maximum pressure for seating beads.</b>

## Suspensions

### Front Suspension Lubrication

Suspension Grease
Synthetic suspension grease

Lubricate upper and lower suspension arms.

There are 2 grease fittings on each suspension arm.



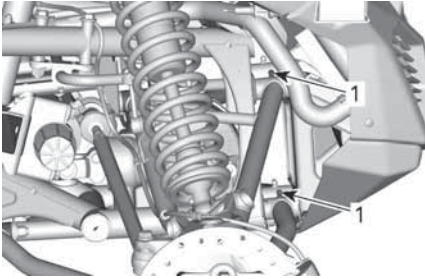

**TYPICAL - FRONT SUSPENSION**

1. Grease fittings

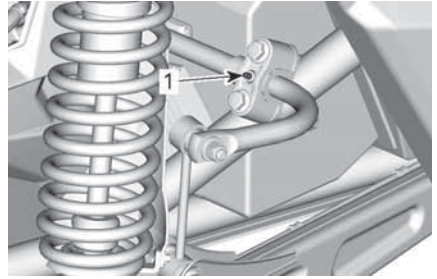

**TYPICAL - REAR STABILIZER BAR**

1. Grease fitting

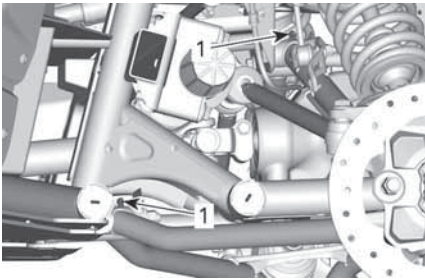

**TYPICAL - FRONT SUSPENSION**

1. Grease fittings

**Stabilizer Bar Lubrication**

<b>Suspension Grease</b>
Synthetic suspension grease

There is one grease fitting on each front suspension side.

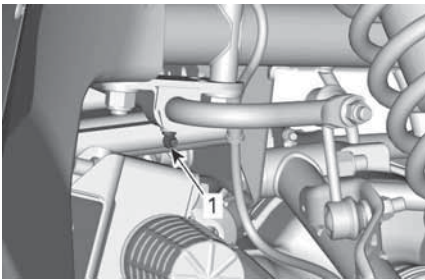

**TYPICAL - FRONT STABILIZER BAR**

1. Grease fitting

There is one grease fitting on each rear suspension side.

**Suspension Inspection**

See an authorized Can-Am dealer, a repair shop or person of your choosing if any problem is detected.

**Shock Absorbers**

Inspect shock absorber for leaks, bump stop wear out or other damages. Verify fasteners are still well tightened.

**Front Suspension Arms**

Check suspension arms for cracks, bending or other damages.

**Rear Suspension Arms**

Check suspension arms, trailing and control links for cracks, bending or other damages.

Verify the transverse suspension arm nuts tightening torque.

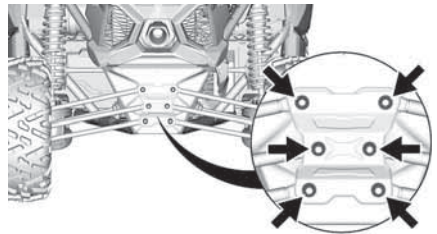

<b>Tightening Torque</b>	
Transverse arm nuts	$95 \pm 5$ Nm ( $70 \pm 4$ lbf-ft)

## Brakes

### Brake Fluid Reservoir Level Verification

Remove the front service cover.

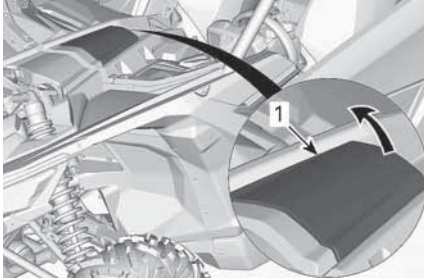

1. Front service cover

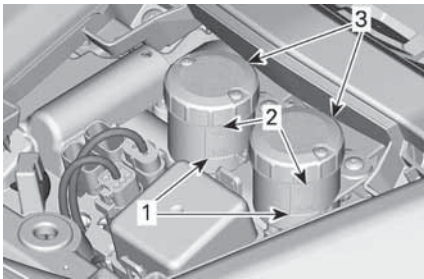

1. MIN
2. MAX
3. Master cylinder reservoirs

With vehicle on a level surface, check brake fluid in reservoirs for proper level. Brake fluid level should be between MIN and MAX marks.

#### NOTE:

A low level may indicate leaks or worn brake pads.

### Adding Brake Fluid

Clean filler cap before removing.

Add fluid as required. **Do not overfill.**

#### NOTE:

Ensure filler cap diaphragm is pushed inside the cap before closing the brake fluid reservoir.

### Recommended Brake Fluid

Always use brake fluid meeting the specification DOT 4 only.

#### **⚠ WARNING**

**To avoid serious damage to the braking system, do not use fluids other than the recommended one, nor mix different fluids for topping up.**

### Brake Inspection

The brake inspection, maintenance and repair should be performed by an authorized Can-Am dealer, a repair shop or person of your choosing.

However, verify the following between visits to your dealer:

- Brake fluid level
- Brake system for fluid leaks
- Brake pad wear
- Brake cleanliness

#### **⚠ WARNING**

**The brake fluid replacement or brake system maintenance and repairs should be performed by an authorized Can-Am dealer.**

## Seat Belts

### Seat Belt Cleaning

To clean dirt and debris from the seat belts, sponge the straps with mild soap and water. Do not use bleach, dye, or household detergents.

#### **⚠ WARNING**

**Do not use pressure washer to clean seat belt components. Use of pressure washer can permanently damage seat belt components.**

## Cage

### Cage Fasteners

Tighten cage fasteners to specification periodically.

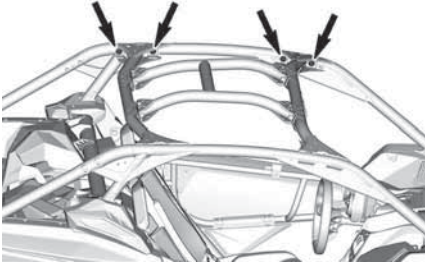

**LH LATERAL CAGE**

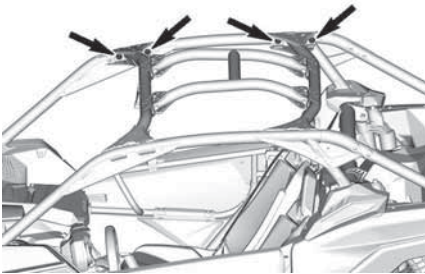

**RH LATERAL CAGE**

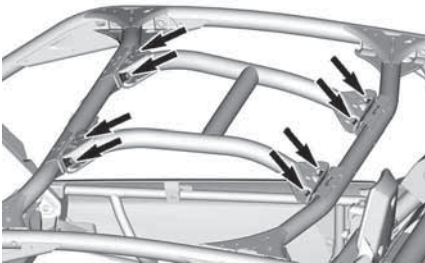

**CENTRAL REINFORCEMENT**

Tightening Torque	
Lateral cage fasteners	110 ± 10 Nm (81 ± 7 lbf-ft)
Central reinforcement fasteners	95 ± 5 Nm (70 ± 4 lbf-ft)

---

# VEHICLE CARE

## Post-Operation Care

When vehicle is used in salt-water environment rinsing the vehicle with fresh water is necessary to preserve vehicle and its components.

Metallic parts lubrication is highly recommended.

This must be performed at the end of each operating day.

Use anti-corrosive lubricant or an equivalent.

Service Product
Lubricant and anti-corrosive

When vehicle is operated in muddy conditions, rinsing the vehicle is recommended to preserve vehicle and its components.

## Vehicle Cleaning and Protection

<b>NOTICE</b>
<b>Pay attention when cleaning the inside of the vehicle, the climate control module installed in the Limited models is not waterproof nor water resistant.</b>

Never use a high pressure washer to clean the vehicle. **USE LOW PRESSURE ONLY (like a garden hose).** High pressure can cause damage to electrical or mechanical components.

Pay attention to certain areas where mud or debris can accumulate and potentially cause wear, interferences or promote corrosion. The list includes but is not limited to:

- Around exhaust system and between muffler and muffler cover
- Under and around the fuel tank
- Radiator
- Shock absorbers
- Around front and rear differentials

- Around and underneath engine and gearbox
- Inside wheels
- On top of skid plates.

Painted parts which are damaged should be properly repainted to prevent rust.

When required, wash the body with warm water and soap (only use mild detergent). Apply non-abrasive wax.

<b>NOTICE</b>
<b>Never clean plastic parts with strong detergent, degreasing agent, paint thinner, acetone, etc.</b>

---

## STORAGE AND PRESEASON PREPARATION

When a vehicle is not in use for more than 4 months, proper storage is a necessity.

If the vehicle is to be remain inactive for more than 21 days, disconnect the BLACK (-) cable of the battery.

The use of a low amperage trickle charger is recommended to keep battery fully charged.

Before using your vehicle after storage, a preparation is required.

See an authorized Can-Am Off-road dealer, a repair shop, or a person of your own choosing to have your vehicle prepared properly.

While reading this Operator's Guide, remember that:



### **WARNING**

Indicates a potential hazard which, if not avoided, could result in serious injury or death.

This page is intentionally blank

# TECHNICAL INFORMATION

# VEHICLE IDENTIFICATION

The main components of your vehicle (engine and frame) are identified by different serial numbers. It may sometimes become necessary to locate these numbers for warranty purposes or to trace your vehicle in the event of loss. These numbers are required by the authorized Can-Am dealer to complete warranty claims properly. We strongly recommend that you take note of all the serial numbers on your vehicle and supply them to your insurance company.

## Vehicle Identification Number

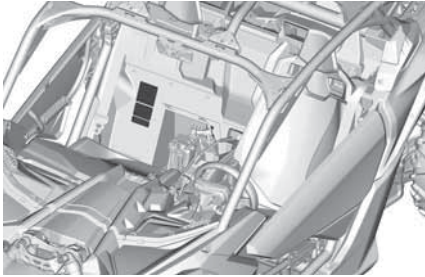

TYPICAL



TYPICAL - VIN LABEL BEHIND PASSENGER SEAT

## Engine Identification Number

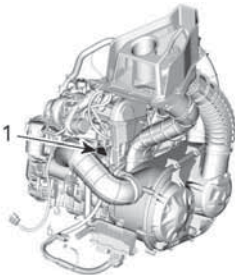

TYPICAL — ENGINE SERIAL NUMBER LABEL

1. EIN (Engine Identification Number)

## Compliance Label

### Regulation (EU) 2016/1628 Applicable for Non-Road Mobile Machineries

Vehicles who comply to Regulation (EU) 2016/1628 (NRMM) are identified on the engine valve cover as well as on the vehicle, near the VIN label.

#### NOTE:

Only the vehicles who have an inter-cooler are NRMM certified.

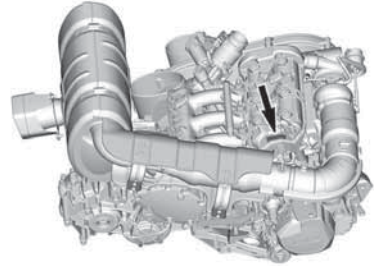

TYPICAL

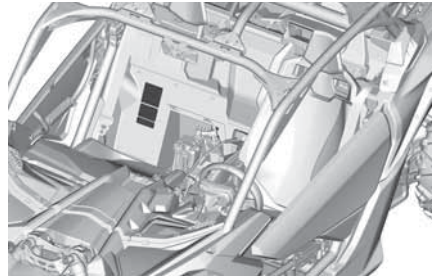

TYPICAL

8639		Rotax NRSC G1 CO2 g/kWh:	XXXX
		#	MXXXXXXXX
		Production date:	MM-YYYY
		Family type:	XXXXXX
		<span style="border: 1px solid black; padding: 2px;">e13</span>	AT1/P V-####

TYPICAL NRMM IDENTIFICATION LABEL

#### NOTE:

Tampering with the engine or its components voids the EU type-approval of that particular engine.



---

# RADIO FREQUENCY DIGITALLY ENCODED SECURITY SYSTEM (RF D.E.S.S. KEY)

This device complies with FCC Part 15 and Industry Canada license exempt RSS standard(s).

Operation is subject to the following two conditions: (1) this device may not cause interference, and (2) this device must accept any interference, including interference that may cause undesired operation of the device.

Changes or modifications not expressly approved by the party responsible for compliance could void the user's authority to operate the equipment.

IC Registration Number:  
12006A-1001002222

FCC ID: 2ACER-1001002222

We, the party responsible for compliance, declare under our sole responsibility that the device is in conformity with the provisions of the following Council Directive: 2014/53/EU. To which this declaration relates is in conformity with the essential requirements and other relevant requirements. The product is in conformity with the following directives, harmonized standards and regulations:

Radio Equipment Directive (RED) 2014/53/EU and Harmonized Standards:

IEC 62368-1:2014, CISPR 25:2016, ISO 11452-2:2004, ETSI EN 300 330 V2.1.1:2017

Radio Equipment Statutory Instrument 2017/1206 and Designated Standards:

IEC 62368-1:2014, CISPR 25:2016, ISO 11452-2:2004, ETSI EN 300 330 V2.1.1:2017

---

# EVAPORATIVE EMISSION CONTROL SYSTEM

## California Models with Evaporative Emission Control System

Beginning with the 2018 model-year vehicles, some California models are certified to meet the CARB (California Air Resources Board) TP-933. These models are equipped with an evaporative emission control system consisting of a low permeation fuel tank (LPFT), low permeation fuel lines (LPFL) and an actively purged carbon canister.

The following statement is required by the CCR (California Code of Regulation): An add-on or modified part must be compliant with applicable ARB evaporative emission control standards. A violation of this requirement is punishable by civil and/or criminal punishment.

---

# NOISE EMISSION CONTROL SYSTEM REGULATION

## USA and Canada Only

### **Tampering with Noise Control System Is Prohibited!**

U.S. Federal law and Canadian provincial laws may prohibit the following acts or the causing there of:

1. The removal or rendering inoperative by any person other than for purposes of maintenance, repair or replacement of any device or element of design incorporated into any new vehicle for the purpose of noise control prior to its sale or delivery to the ultimate purchaser or while it is in use or
2. The use of the vehicle after such device or element of design has been removed or rendered inoperative by any person.

### **Among those Acts Presumed to Constitute Tampering Are the Acts Listed Below:**

1. Removal or alteration or the puncturing of the mufflers or any engine component which conducts removal of engine exhaust gases.
2. Removal or alteration or the puncturing of any part of the intake system.
3. Replacing any moving parts of the vehicle or parts of the exhaust or intake system, with parts other than those specified by the manufacturer.
4. Lack of proper maintenance.

# EC-DECLARATION OF CONFORMITY



565 de la Montagne Street  
Valcourt (Québec) J0E 2L0  
Canada  
www.brp.com

## EU Declaration of Conformity

**Authorized Representative:** BRP Europe N.V., Skaldenstraat 125, Gent, Belgium, 9042

This declaration of conformity is issued under the sole responsibility of the manufacturer.

The undersigned, representing the manufacturer, hereby declares that model year **2022 Side by Side Vehicles** marked with the **CE** mark and a 17-character vehicle identification number (VIN) structured as **3JBxxxxxxNxxxxxxx** under commercial names **Can-Am Traxter, Can-Am Maverick Sport** and **Can-Am Maverick** comply with all the relevant provisions of the following Directives and Regulations:

Machinery (MD) Directive 2006/42/EC as amended up to and including Regulation (EU) 2019/1243	ISO 12100:2010 & EN 16990:2020
Non-Road Mobile Machinery (NRMM) Regulation (EU) 2016/1628 on gaseous pollutants as amended up to and including Regulation (EU) 2020/1040	Category ATS, Stage V emission limits
Electromagnetic Compatibility (EMC) Directive 2014/30/EU as amended up to and including Regulation (EU) 2018/1139	CISPR 12:2007/A1:2009 & IEC 61000-6-1:2016 or UN R10.04 or later version
Battery Directive 2006/66/EC as amended up to and including Directive (EU) 2018/849 and, Regulation (EU) 1103/2010 on battery capacity labelling	EN 50342-7:2015
Radio Equipment (RED) Directive 2014/53/EU as amended up to and including Regulation (EU) 2018/1139 (If fitted with radio frequency (RF) D.E.S.S. key)	Art. 3.1a: IEC 62368-1:2014 Art. 3.1b: CISPR 25:2016 & ISO 11452-2:2004 Art. 3.2: ETSI EN 300 330 V2.1.1:2017

Luc Bouchard, Eng.  
Director, Product Development, Can-Am SSV  
Bombardier Recreational Products Inc.

Valcourt, QC, Canada

March 5, 2021

*ski-doo LYNX SEAWOO EVRIDE ROTAX CAN-AM*



565 de la Montagne Street  
Valcourt (Quebec) J9E 2L0  
Canada  
www.brp.com

## UK Declaration of Conformity

**Authorized Representative:** BRP Recreational Products UK Ltd.,  
Castle Chambers, 43 Castle Street, Liverpool, L2 9SH

This declaration of conformity is issued under the sole responsibility of the manufacturer.

The undersigned, representing the manufacturer, hereby declares that model year **2022 Side by Side Vehicles** marked with the <sup>UK</sup>CA mark and a 17-character vehicle identification number (VIN) structured as **3JBxxxxxNxxxxxx** under commercial names **Can-Am Traxter, Can-Am Maverick Sport** and **Can-Am Maverick** comply with all the relevant provisions of the following Statutory Instruments :

Supply of Machinery (Safety) Regulations 2008, UK SI 2008/1597 as amended up to and including SI 2020/1112	ISO 12100:2010 & EN 16990:2020
Non-Road Mobile Machinery (Type-Approval and Emission of Gaseous and Particulate Pollutants) Regulations 2018, UK SI 2018/764 as amended up to and including SI 2020/1393	Category ATS, Stage V emission limits
Electromagnetic Compatibility Regulations 2016, UK SI 2016/1091 as amended up to and including SI 2020/1112	CISPR 12:2007/A1:2009 & IEC 61000-6-1:2016 or UN R10.04 or later version
Batteries and Accumulators (Placing on the Market) Regulations 2008, UK SI 2008/2164 as amended up to and including UK SI 2020/904	EN 50342-7:2015
Radio Equipment Regulations 2017, UK SI 2017/1206 as amended up to and including SI 2020/1112	Art. 3.1a: IEC 62368-1:2014 Art. 3.1b: CISPR 25:2016 & ISO 11452-2:2004
(If fitted with radio frequency (RF) D.E.S.S. key)	Art. 3.2: ETSI EN 300 330 V2.1.1:2017

Luc Bouchard, Eng.  
Director, Product Development, Can-Am SSV  
Bombardier Recreational Products Inc.

Valcourt, QC, Canada

March 5, 2021

*ski-doo LYNX SENADO EVARUDE ROTAX CAN-AM*

---

# EAC DECLARATION OF CONFORMITY

**Left blank for Eurasian Conformity  
mark where applicable**

# **TECHNICAL SPECIFICATIONS**

# TECHNICAL SPECIFICATIONS

Engine		
Engine type	ROTAX® 900 ACE TURBO / TURBO RR	
	4-stroke, Double Over Head Camshaft (DOHC), dry sump, liquid cooled	
Number of cylinders	3	
Number of valves	12 valves (self adjusting hydraulic valve lifters)	
Bore	74 mm (2.91 in)	
Stroke	69.7 mm (2.74 in)	
Displacement	899.31 cm <sup>3</sup> (54.88 in <sup>3</sup> )	
Maximum HP RPM	Turbo	7250 RPM
	Turbo RR	7800 RPM
Exhaust system	Spark arrester approved by USDA Forest Service Catalyst on NRMM models	
Air filter	Donaldson high performance filter	



Lubrication System		
Type		Dry sump
Oil filter	Oil filter	Replaceable cartridge oil filter
Engine oil	Capacity	3.5 l (3.7 qt(liq.,US))
	Recommended oil	XPS 4T 5W40 Synthetic oil or XPS 4T 10W50 Synthetic oil
	Alternate oil if XPS products are not available	If not available, use a 5W40 or 10W50 motor oil that meets the requirements for API service classification SJ, SL, SM or SN. Refer to <i>recommended oil</i>

Cooling System		
Coolant	Type	Extended life pre-mixed coolant. Ethyl glycol / water mix (50%/50%). or coolant specifically designed for aluminum engines
	Capacity	6.9 l (1.82 gal(liq.,US))

Transmission		
Type		CVT (Continuously Variable Transmission)
Engagement	Turbo	2050 RPM
	Turbo RR	1950 RPM

Electrical System		
Spark plug	Quantity	3
	Make and type	NGK LMAR9AI-8D
	Gap	0.7 to 0.8 mm(.028 to .031 in)

Electrical System		
Battery	Type	Maintenance free SLA
	Voltage	12 volts
	Nominal rating	18 A•h
	Power starter output	1.34 kW
Headlight		2 x 20W LED
Taillight		2 x 3W LED
Signature lights		2 x 2W LED
Fuses		Refer to <i>Fuses in Maintenance</i>

Fuel System			
Fuel pump	Type	Electric (in fuel tank)	
Fuel	Type	Premium unleaded gasoline - Refer to <i>Fuel Requirements</i>	
	Minimum Octane rating	North America	87 AKI (R+M)/2
		Outside North America	92 RON
	Recommended Octane rating	North America	91 AKI (R+M)/2
		Outside North America	95 RON
Fuel tank capacity		± 40 l (10.6 gal(liq.,US))	
Fuel remaining when low fuel light turns ON		± 12 l (3.2 gal(liq.,US))	

<b>Gearbox</b>		
Type		Dual range (HI-LO) with PARK, neutral and reverse
Gearbox oil	Capacity	1.25 l (42 fl oz(US)) refill (1.5 l (51 fl oz(US)) when new)
	Recommended	XPS 75W140 Synthetic gear oil or synthetic gear oil 75W140 API GL-5

<b>Drive System</b>		
Front drive		Selectable 2WD / 4WD with Smart-Lok electronic locking differential and front diff lock, spiral gears
Front drive ratio		3.6:1
Rear drive		Integrated to transmission, helical gears
Rear drive ratio		3.43:1
Front differential oil	Capacity	350 ml (11.83 fl oz(US))
	Recommended	XPS 75W90 Synthetic gear oil or synthetic gear oil 75W90 API GL-5
CV joint grease		CV joint grease

<b>Steering</b>	
Type	Rack and pinion
Steering wheel	Adjustable tilt steering

Front Suspension			
Suspension type		Double suspension arm with stabilizer bar	
Suspension travel	X rc Turbo RR 64 in	457 mm (18 in)	
	DS Turbo DS Turbo RR X ds Turbo RR	508 mm (20 in)	
	X rs Turbo RR RS Turbo RR X rs with Smart-Shox X rc Turbo RR 72 in	Up to 559 mm (22 in)	
Shock absorber	Quantity		2
	Type	DS Turbo DS Turbo RR RS Turbo RR X rc Turbo RR 64 in	FOX† 2.5 PODIUM shocks with piggyback reservoir. QS3† compression adjustments
		X ds Turbo RR	FOX† 2.5 PODIUM shocks with piggyback reservoir and dual speed compression and rebound adjustments
		X rs Turbo RR X rc Turbo RR 72 in	FOX† 2.5 PODIUM shocks with piggyback reservoir and bypass, dual speed compression and rebound adjustments
		X rs Turbo RR with Smart-Shox	FOX† Semi-Active shocks with 3 preset modes
Preload adjustment type		Threaded	

Rear Suspension			
Suspension type		Torsional Trailing Suspension-arm Independent (TTX) with external stabilizer bar	
Suspension travel	X rc Turbo RR 64 in	457 mm (18 in)	
	DS Turbo DS Turbo RR X ds Turbo RR	508 mm (20 in)	
	RS Turbo RR	559 mm (22 in)	
	X rs Turbo RR X rs with Smart-Shox X rc Turbo RR 72 in	610 mm (24 in)	
Shock absorber	Quantity		2
	Type	DS Turbo DS Turbo RR RS Turbo RR X rc Turbo RR 64 in	FOX† 2.5 PODIUM shocks with piggyback reservoir. QS3† compression adjustments with bottom-out control
		X ds Turbo RR	FOX† 2.5 PODIUM shocks with piggyback reservoir and dual speed compression and rebound adjustments and bottom out control
		X rs Turbo RR X rc Turbo RR 72 in	FOX† 3.0 PODIUM shocks with remote reservoir with bypass, dual speed compression and rebound adjustments
		X rs Turbo RR with Smart-Shox	FOX† Semi-Active shocks with 3 preset modes
Preload adjustment type		Threaded	

<b>Brakes</b>		
Front brake	Qty	2
	Type	262 mm (10.3 in) ventilated brake disc with hydraulic twin-pistons calipers of 32 mm (1.26 in)
Rear brake	Qty	2
	Type	248 mm (9.8 in) ventilated brake disc with hydraulic twin-pistons calipers of 28 mm (1.1 in)
Brake fluid	Type	DOT 4
	Capacity	310 ml (10.5 fl oz(US))
Caliper		Floating
Brake pad material		Sintered high performance
Minimum brake pad thickness		0.5 mm (.02 in)
Minimum brake disc thickness		4 mm (.157 in)
Maximum brake disc warpage		0.2 mm (.01 in)

Tires			
Pressure		Front	Recommended tire inflation pressure is found on the Tire Label. Refer to appropriate <i>Important On-Product Labels</i> section for its locations.
Size	Front	DS Turbo DS Turbo RR RS Turbo RR X rc Turbo RR 64 in X ds Turbo RR	255/80R14 (30x10R14)
		X rs Turbo RR X rs Turbo RR Smart-Shox	255/80R14 (32x10R14)
		X rc Turbo RR 72 in	255/85R15 (32x10R15)
	Rear	DS Turbo DS Turbo RR RS Turbo RR X rc Turbo RR 64 in X ds Turbo RR	255/80R14 (30x10R14)
		X rs Turbo RR X rs Turbo RR Smart-Shox	255/80R14 (32x10R14)
		X rc Turbo RR 72 in	255/85R15 (32x10R15)
Minimum tire thread depth			3 mm (.118 in)

<b>Wheels</b>			
Type		DS Turbo X rc Turbo RR 64 in DS Turbo RR RS Turbo RR	Cast aluminum wheels
		X ds Turbo RR X rs Turbo RR X rc Turbo RR 72 in	Cast aluminum beadlock wheels
Rim size	Front	All other models	35.6 x 17.8 cm (14 x 7 in)
		X rc Turbo RR 72 in	38.1 x 17.8 cm (15 x 7 in)
	Rear	All other models	35.6 x 17.8 cm (14 x 7 in)
		X rc Turbo RR 72	38.1 x 17.8 cm (15 x 7 in)
Wheel lug nuts torque			120 ± 5 Nm (89 ± 4 lbf-ft)
Wheel Offset	Front	DS Turbo DS Turbo RR RS Turbo RR	55.1 mm (2.2 in)
		X ds Turbo RR X rs Turbo RR	55 mm (2.2 in)
		X rc Turbo RR 64 in	41.2 mm (1.6 in)
		X rc Turbo RR 72 in	46.4 mm (1.8 in)
	Rear	DS Turbo DS Turbo RR X ds Turbo RR	76.2 mm (3 in)
		RS Turbo RR	51.5 mm (2 in)
		X rs Turbo RR	53 mm (2.1 in)
		X rc Turbo RR 64 in X rc Turbo RR 72 in	41.2 mm (1.6 in) 46.4 mm (1.8 in)
<b>Chassis</b>			
Cage type			Dual-phase 980 steel



Dimensions		
Overall length	DS Turbo DS Turbo RR RS Turbo RR X ds Turbo RR X rs Turbo RR X rs Turbo RR Smart-Shox	335.3 cm (132 in)
	X rc Turbo RR 64 in	337.8 cm (133 in)
	X rc Turbo RR 72 in	341.6 cm (134.5 in)
Overall width	DS Turbo DS Turbo RR X ds Turbo RR	162.5 cm (64 in)
	X rs Turbo RR X rs Turbo RR Smart-Shox	184.7 cm (72.7 in)
	X rc Turbo RR 64 in	166.6 cm (65.6 in)
	X rc Turbo RR 72 in	184.9 cm (72.8 in)
	RS Turbo RR	183.9 cm (72.4 in)
Overall height	DS Turbo DS Turbo RR	166.1 cm (65.4 in)
	X ds Turbo RR	166.9 cm (65.7 in)
	X rc Turbo RR 64 in	167.6 cm (66 in)
	RS Turbo RR X rs Turbo RR X rs Turbo RR Smart-Shox X rc Turbo RR 72 in	174 cm (68.5 in)
Wheelbase		259.1 cm (102 in)

Dimensions			
Wheel track	Front	DS Turbo DS Turbo RR X ds Turbo RR	136 cm (53.5 in)
		RS Turbo RR X rc Turbo RR 64 in X rc Turbo RR 72 in X rs Turbo RR X rs Turbo RR Smart-Shox	156.4 cm (61.6 in)
	Rear	DS Turbo DS Turbo RR X ds Turbo RR	133.1 cm (52.4 in)
		RS Turbo RR X rc Turbo RR 64 in X rc Turbo RR 72 in X rs Turbo RR X rs Turbo RR Smart-Shox	153.4 cm (60.4 in)
	Ground clearance		DS Turbo DS Turbo RR X ds Turbo RR X rc Turbo RR 64 in
		RS Turbo RR	39.4 cm (15.5 in)
		X rs Turbo RR X rs Turbo RR Smart-Shox X rc Turbo RR 72 in	40.6 cm (16 in)

Loading Capacity and Weight		
Dry weight	DS Turbo DS Turbo RR	671.9 kg (1,481 lb)
	X ds Turbo RR	680.9 kg (1,501 lb)
	X rs Turbo RR	738 kg (1,627 lb)
	X rs Turbo RR Smart-Shox	747 kg (1,646 lb)
	X rc Turbo RR 64 in	744.8 kg (1,642 lb)
	RS Turbo RR	735 kg (1,620 lb)
	X rc Turbo RR 72 in	821.5 kg (1,811 lb)
Weight distribution (front/rear)		45/55
Total vehicle load allowed (including driver, passengers, all other loads and added accessories)		286 kg (630 lb)
Gross vehicle weight rating	DS Turbo DS Turbo RR	1025 kg (2,259 lb)
	RS Turbo RR	1082 kg (2,386 lb)
	X rc Turbo RR 64 in	1 083 kg (2,387 lb)
	X rc Turbo RR 72 in	1 159 kg (2,556 lb)
	X rs Turbo RR	1 086 kg (2,393 lb)
	X rs Turbo RR Smart-Shox	1 094 kg (2,412 lb)
	X ds Turbo RR	1028 kg (2,267 lb)
Cargo rack capacity		91 kg (200 lb)

**Machinery Directive 2006/42/EC Compliant Models**

MODEL		900 ACE TURBO RR
<b>NOISE EMISSION AND VIBRATION VALUES<sup>1</sup></b>		
Noise	Sound pressure level ( $L_{pA}$ )	83 dB (A) (Uncertainty ( $K_{pA}$ ) 3dB)
	Sound power level ( $L_{WA}$ )	99 dB (A) (Uncertainty ( $K_{WA}$ ) 3dB)
Vibration	Hand-arm system	Less than 2.5 m/s <sup>2</sup>
	Whole body at seat	Less than 0.5 m/s <sup>2</sup>
<sup>1</sup> : Noise emission and Vibration values are measured in accordance with Machinery Directive 2006/42/EC on a paved surface, at neutral or without belt.		

# TROUBLESHOOTING

# TROUBLESHOOTING GUIDELINES

## CVT BELT IS SLIPPING

1. **Water has entered in the CVT.**
  - *Refer to Special Procedures.*

## "-" IS DISPLAYED ON THE GEARBOX POSITION DISPLAY

1. **Shift lever is between 2 positions.**
  - *Properly position the shift lever in the desired position.*
2. **Shift lever is not properly adjusted.**
  - *Contact an authorized Can-Am dealer.*
3. **Electrical communication error.**
  - *Contact an authorized Can-Am dealer.*

## ENGINE DOES NOT TURN

1. **D.E.S.S. key is not installed on D.E.S.S. post.**
  - *Securely install key to D.E.S.S. post.*
2. **Shift lever is not set on PARK.**
  - *Set shift lever to either in PARK or press the brake pedal.*
3. **Burnt fuse.**
  - *Check fuses.*
4. **Weak battery or loose connections.**
  - *Check charging system fuse.*
  - *Check fault message in cluster.*
  - *Check battery connections and terminals condition.*
  - *Have the battery checked by an authorized Can-Am dealer.*
5. **Defective engine start button.**
  - *Contact an authorized Can-Am dealer.*
6. **Defective starter solenoid.**
  - *Contact an authorized Can-Am dealer.*
7. **D.E.S.S. key not recognized is displayed in the multifunction gauge.**
  - *Clean D.E.S.S. key.*

## ENGINE TURNS OVER BUT FAILS TO START

### 1. Flooded engine (spark plug wet when removed).

- *(If the engine does not start and it is fuel-flooded, the drowned mode can be activated to prevent fuel injection and to cut ignition while cranking. Proceed as follows:*
    - *Install key on D.E.S.S. post.*
    - *Press completely and HOLD accelerator pedal.*
    - *Press the engine START button.*
- The engine should be cranked for 10 seconds. Release engine START button.*
- Release accelerator pedal and start/crank engine again to allow starting.*
- If it does not work:**
- *Remove the spark plugs (tools are supplied in tool kit). Refer to Spark Plugs in Maintenance Procedures.*
  - *Crank engine several times.*
  - *Install new spark plugs if possible or clean and dry spark plugs.*
  - *If engine does not start, seek service from an authorized Can-Am dealer, repair shop, or person of your own choosing for maintenance, repair, or replacement. Please refer to the US EPA Emission-Related Warranty contained herein for information about warranty claims.*

### 2. No fuel to the engine (spark plug dry when removed).

- *Check fuel tank level.*
- *Check fuel pump fuse.*
- *Obstructed fuel pump pre-filter or fuel pump failure. Seek service from an authorized Can-Am dealer, repair shop, or person of your own choosing for maintenance, repair, or replacement. Please refer to the US EPA Emission-Related Warranty contained herein for information about warranty claims.*

### 3. Spark plug/ignition (no spark).

- *Check ignition fuse.*
- *Remove spark plug then reconnect to ignition coil.*
- *Start engine with spark plug grounded to the engine away from spark plug hole. If no spark appears, replace spark plug.*
- *If trouble persists, seek service from an authorized Can-Am dealer, repair shop, or person of your own choosing for maintenance, repair, or replacement. Please refer to the US EPA Emission-Related Warranty contained herein for information about warranty claims.*

**ENGINE LACKS ACCELERATION OR POWER**

1. **Seat belt not buckled properly. Check cluster message.**
  - *Buckle up seat belt.*
2. **Fouled or damaged spark plug.**
  - *Replace spark plugs.*
3. **Engine air filter plugged or dirty.**
  - *Check air filter and replace if necessary.*
  - *Check deposits in engine air filter housing.*
4. **Water in CVT**
  - *Drain water from CVT. Refer to Special Procedures.*
5. **CVT dirty or worn-out.**
  - *Contact an authorized Can-Am dealer.*
6. **Lack of fuel**
  - *Dirty or clogged fuel pump pre-filter. Seek service from an authorized Can-Am dealer, repair shop, or person of your own choosing for maintenance, repair, or replacement. Please refer to the US EPA Emission-Related Warranty contained herein for information about warranty claims.*
7. **Engine is in Torque Limitation mode (if equipped).**
  - *Engine torque is gradually limited for protection when coolant temperature is too high. Check multifunction gauge display for engine temperature.*
  - *Let engine cool down.*
8. **Engine is in limp home mode.**
  - *Multifunction gauge CHECK ENGINE indicator lamp is on and display shows LIMP HOME, seek service from an authorized Can-Am dealer, repair shop, or person of your own choosing for maintenance, repair, or replacement. Please refer to the US EPA Emission-Related Warranty contained herein for information about warranty claims.*

**ENGINE OVERHEATS**

1. **Low coolant level in cooling system.**
  - *Check coolant level and refill. See Maintenance Procedures. Seek service from an authorized Can-Am dealer, repair shop, or person of your own choosing for maintenance, repair, or replacement. Please refer to the US EPA Emission-Related Warranty contained herein for information about warranty claims.*
2. **Cooling fan is not working.**
  - *Ensure cooling fan is not jammed and working properly.*
  - *Check fan fuse. See Fuses in the Maintenance Procedures.*
3. **Dirty radiators fins.**
  - *Check and clean radiator fins. See Maintenance Procedures.*



**ENGINE MISFIRE**

1. **Fouled/damaged/worn spark plug.**
  - *Replace spark plugs as required.*
2. **Water in fuel.**
  - *Drain fuel system and refill with fresh fuel.*

**THE RPM INCREASES BUT THE VEHICLE DOES NOT MOVE**

1. **Water in the CVT.**
  - *Drain water from CVT. See Special Procedures.*
2. **CVT dirty or worn-out or belt failure.**
  - *Contact an authorized Can-Am dealer.*

**PARTIAL OR NO RESPONSE FROM THE ACCELERATOR PEDAL INPUTS (CHECK ENGINE IS ON AND PPS FAULT MESSAGE IS DISPLAYED)**

1. **Partial failure of the accelerator pedal sensors (PPS).**
  - *Use the override switch to retrieve accelerator pedal operation. Contact an authorized Can-Am dealer.*
2. **Total failure of the accelerator pedal sensors (PPS).**
  - *Use the override switch to bypass the accelerator pedal and increase the engine speed in order to move vehicle. Contact an authorized Can-Am dealer.*

**SHOCK ICON IS BLINKING FAST WHILE VEHICLE MALFUNCTION TELLTALE IS ON**

1. **Partial failure of Smart-Shox system: Front or rear shock absorbers become full stiff (Sport+ like).**
  - *Change Smart-Shox mode to Sport+ to have a similar setting at front and rear. The vehicle remains rideable. Contact an authorized Can-Am dealer.*
2. **Total failure of Smart-Shox system: Front and rear shock absorbers become full stiff (Sport+ like).**
  - *The vehicle remains rideable. Contact an authorized Can-Am dealer.*

---

## MESSAGES IN MULTIFUNCTION GAUGE

If an abnormal engine condition occurs, the following messages can be combined with a pilot lamp.

Message	Description
D.E.S.S. KEY NOT RECOGNIZED	D.E.S.S. key requires cleaning.
BAD KEY	Indicates that you have used the wrong D.E.S.S. key, use the proper key for this vehicle.
CHECK ENGINE	All active or previously activated faults that require attention. No engine limitation engaged.
LIMP HOME	Critical faults requiring diagnostic as soon as possible. An engine limitation is engaged and/or the engine behavior is modified.
TPS FAULT	Throttle body fault, generally followed by a Limp Home message.
BRAKE SWITCH FAULT	Brake signal fault.
CHECK DPS	Check engine pilot light on. Indicates that the DPS (Dynamic Power Steering) does not work properly. See an authorized Can-Am dealer.
PPS FAULT	Faulty Pedal Position Sensor(s) (PPS). Refer to <i>Override Switch</i> in <i>Secondary Controls</i> to drive the vehicle in the limp home mode.
MANUAL LIMP HOME	Confirms the Manual Limp Home is engaged using the <i>Override Switch</i> in case of a PPS fault.
FUEL SENSOR FAULT	When the fuel sender resistor value is out of range the multifunction gauge (analog/digital) will detect it and display the message.
CHECK SMART-LOK	Check engine pilot light on. Indicates that the Smart-Lok does not work properly. See an authorized Can-Am dealer.

# WARRANTY

---

# **BRP LIMITED WARRANTY USA AND CANADA: 2022 CAN-AM® SSV**

## **1) SCOPE OF THE LIMITED WARRANTY**

Bombardier Recreational Products Inc. (“BRP”) warrants its 2022 Can-Am side-by-side vehicles (“SSV”) sold by authorized Can-Am SSV dealers (as hereinafter defined) in the United States of America (“USA”) and in Canada from defects in material or workmanship for the period and under the conditions described below. This limited warranty will become null and void if:

1. The SSV was used for racing or any other competitive activity, at any point, even by a previous owner; or
2. The SSV has been altered or modified in such a way so as to adversely affect its operation, performance or durability, or has been altered or modified to change its intended use.

Non-factory installed parts and accessories are not covered under this limited warranty. Please refer to the applicable parts and accessories limited warranty text.

## **2) LIMITATIONS OF LIABILITY**

**THIS WARRANTY IS EXPRESSLY GIVEN AND ACCEPTED IN LIEU OF ANY AND ALL OTHER WARRANTIES, EXPRESSED OR IMPLIED, INCLUDING WITHOUT LIMITATION ANY WARRANTY OF MERCHANTABILITY OR FITNESS FOR A PARTICULAR PURPOSE. TO THE EXTENT THAT THEY CANNOT BE DISCLAIMED, THE IMPLIED WARRANTIES ARE LIMITED IN DURATION TO THE LIFE OF THE EXPRESS WARRANTY. INCIDENTAL AND CONSEQUENTIAL DAMAGES ARE EXCLUDED FROM COVERAGE UNDER THIS WARRANTY. SOME STATES/ PROVINCES DO NOT ALLOW FOR THE DISCLAIMERS, LIMITATIONS AND EXCLUSIONS IDENTIFIED ABOVE, AS A RESULT, THEY MAY NOT APPLY TO YOU. THIS WARRANTY GIVES YOU SPECIFIC RIGHTS, AND YOU MAY ALSO HAVE OTHER LEGAL RIGHTS WHICH MAY VARY FROM STATE TO STATE, OR PROVINCE TO PROVINCE.**

Neither the distributor, any BRP dealer nor any other person has been authorized to make any affirmation, representation or warranty regarding the product, other than those contained in this limited warranty, and if made, shall not be enforceable against BRP. BRP reserves the right to modify this limited warranty at any time, being understood that such modification will not alter the warranty conditions applicable to the products sold while this warranty is in effect.

## **3) EXCLUSIONS – ARE NOT WARRANTED**

The following are not warranted under any circumstances:

- Normal wear and tear;
- Routine maintenance items, tune ups, adjustments;
- Damage caused by failure to provide proper maintenance and/or storage, as described in the Operator’s Guide;
- Damage resulting from removal of parts, improper repairs, service, maintenance, modifications or use of parts not manufactured or approved by BRP or resulting from repairs done by a person that is not an authorized servicing Can-Am SSV dealer;

- Damage caused by abuse, abnormal use, neglect or operation of the product in a manner inconsistent with the recommended operation described in the Can-Am SSV Operator's Guide;
- Damage resulting from accident, submersion, fire, theft, vandalism or any act of God;
- Operation with fuels, oils or lubricants which are not suitable for use with the product (see the Operator's Guide);
- Damages from rust, corrosion or exposure to the elements;
- Damage resulting from water or snow ingestion;
- Incidental or consequential damages, or damages of any kind including without limitation towing, storage, telephone, rental, taxi, inconvenience, insurance coverage, loan payments, loss of time, loss of income.

#### 4) WARRANTY COVERAGE PERIOD

This limited warranty will be in effect from (1) the date of delivery to the first retail consumer or (2) the date the product is first put into use, whichever occurs first and for the following period:

- SIX (6) CONSECUTIVE MONTHS, for private use, commercial use or governmental use owners.
- For emission-related components; please also refer to the *US EPA Emission-Related Warranty* contained herein
- For evaporative emission-related components of California models equipped with evaporative emission control system produced by BRP for sale in the State of California that are originally sold to a resident or subsequently warranty registered to a resident in the State of California, please also refer to the *California Evaporative Emissions Control Warranty Statement* contained herein.

The repair or replacement of parts or the performance of service under this warranty does not extend the life of this warranty beyond its original expiration date.

#### 5) CONDITIONS TO HAVE WARRANTY COVERAGE

This warranty coverage is available **only** if **each** of the following conditions has been fulfilled:

- The 2022 Can-Am SSV must be purchased as new and unused by its first owner from a Can-Am SSV dealer authorized to distribute Can-Am SSV's in the country in which the sale occurred ("Can-Am SSV dealer");
- The BRP specified pre-delivery inspection process must be completed and documented and signed by the purchaser;
- The 2022 Can-Am SSV must have undergone proper registration by an authorized Can-Am SSV dealer;
- The 2022 Can-Am SSV must be purchased in the country in which the purchaser resides;
- Routine maintenance outlined in the Operator's Guide must be timely performed in order to maintain warranty coverage. BRP reserves the right to make warranty coverage contingent upon proof of proper maintenance.

BRP will not honor this limited warranty to any private use owner or commercial use owner if one of the preceding conditions has not been met. Such limitations are necessary in order to allow BRP to preserve both the safety of its products, and also that of its consumers and the general public.

## **6) WHAT TO DO TO OBTAIN WARRANTY COVERAGE**

The customer must cease using the SSV upon the appearance of an anomaly. The customer must notify a servicing BRP dealer within three (3) days of the appearance of a defect, and provide it with reasonable access to the product and reasonable opportunity to repair it. The customer must also present to the authorized BRP dealer, proof of purchase of the product and must sign the repair/work order prior to starting the repair in order to validate the warranty repair. All parts replaced under this limited warranty become the property of BRP.

## **7) WHAT BRP WILL DO**

BRP's obligations under this warranty are limited to, at its sole discretion, repairing parts found defective under normal use, maintenance and service, or replacing such parts with new genuine Can-Am SSV parts without charge for parts and labor, at any authorized BRP dealer during the warranty coverage period under the conditions described herein. BRP's responsibility is limited to making the required repairs or replacements of parts. No claim of breach of warranty shall be cause for cancellation or rescission of the sale of the SSV to the owner.

In the event that service is required outside of the country of original sale, the owner will bear responsibility for any additional charges due to local practices and conditions, such as, but not limited to, freight, insurance, taxes, license fees, import duties, and any and all other financial charges, including those levied by governments, states, territories and their respective agencies.

BRP reserves the right to improve or modify products from time to time without assuming any obligation to modify products previously manufactured.

## **8) ADDITIONAL SUPPLIER WARRANTIES**

A GPS receiver may be supplied by BRP as standard equipment on certain 2022 Can-Am SSV. The GPS receiver is covered under BRP's limited warranty policy. Additional warranty coverage if offered by the GPS receiver "supplier" that is longer than BRP's limited warranty is to be dealt by the dealer or consumer directly with the GPS receiver "supplier".

## **9) TRANSFER**

If the ownership of a product is transferred during the warranty coverage period, this limited warranty, subject to its terms and conditions, shall also be transferred and be valid for the remaining coverage period provided BRP or an authorized Can-Am SSV Distributor/Dealer receives a proof that the former owner agreed to the transfer of ownership, in addition to the co-ordinates of the new owner.

## **10) CONSUMER ASSISTANCE**

In the event of a controversy or a dispute in connection with this limited warranty, BRP suggests that you try to resolve the issue at the dealership level. We recommend discussing the issue with the authorized dealer's service manager or owner.

If the matter still remains unresolved, contact BRP by filling out the customer contact form at [www.brp.com](http://www.brp.com) or contact BRP by mail at one of the addresses listed under the *Contact Us* in *Customer Information*.

---

# US EPA EMISSION - RELATED WARRANTY

Bombardier Recreational Products Inc. ("BRP") warrants to the ultimate purchaser and each subsequent purchaser that this new vehicle, including all parts of its exhaust emission control system and its evaporative emission control system, meets two conditions:

1. It is designed, built, and equipped so it conforms at the time of sale to the ultimate purchaser with the requirements of 40 CFR 1051 and 40 CFR 1060.
2. It is free from defects in materials and workmanship that may keep it from meeting the requirements of 40 CFR 1051 and 40 CFR 1060.

Where a warrantable condition exists, BRP will repair or replace, as it elects, any part or component with a defect in materials or workmanship that would increase the engine's emissions of any regulated pollutant within the stated warranty period at no cost to the owner, including expenses related to diagnosing and repairing or replacing emission-related parts. All defective parts replaced under this warranty become the property of BRP.

For all emission-related warranty claims, BRP is limiting the diagnosis and repair of emission-related parts to the authorized Can-Am dealers, unless for emergency repairs as required by item 2 of the following list.

As a certifying manufacturer, BRP will not deny emission-related warranty claims based on any of the following:

1. Maintenance or other service BRP or BRP's authorized facilities performed.
2. Engine/equipment repair work that an operator performed to correct an unsafe, emergency condition attributable to BRP as long as the operator tries to restore the engine/equipment to its proper configuration as soon as possible.
3. Any action or inaction by the operator unrelated to the warranty claim.
4. Maintenance that was performed more frequently than BRP specify.
5. Anything that is BRP fault or responsibility.
6. The use of any fuel that is commonly available where the equipment operates unless BRP written maintenance instructions state that this fuel would harm the equipment's emission control system and operators can readily find the proper fuel. See maintenance information section and fuel requirements of fueling section.

## Emission-Related Warranty Period

The emission-related warranty is valid for the following period whichever comes

	HOURS	MONTHS	KILOMETERS
Exhaust emission-related components	500	30	5000
Evaporative emission-related components	N/A	24	N/A

## Components Covered

The emission-related warranty covers all components whose failure would increase an engine's emissions of any regulated pollutant, including the following listed components:

1. For exhaust emissions, emission-related components include any engine parts related to the following systems:
  - Air-induction system
  - Fuel system
  - Ignition system
  - Exhaust gas recirculation systems.
2. The following parts are also considered emission-related components for exhaust emissions:
  - After treatment devices
  - Crankcase ventilation valves
  - Sensors
  - Electronic control units.
3. The following parts are considered emission-related components for evaporative emissions:
  - Fuel tank
  - Fuel cap
  - Fuel line
  - Fuel line fittings
  - Clamps\*
  - Pressure relief valves\*
  - Control valves\*
  - Control solenoids\*
  - Electronic controls\*
  - Vacuum control diaphragms\*
  - Control cables\*
  - Control linkages\*
  - Purge valves
  - Vapor hoses
  - Liquid/vapor separator
  - Carbon canister
  - Canister mounting brackets
  - Carburetor purge port connector.

**NOTE:** \*As related to the evaporative emission control system.

4. Emission-related components also include any other part whose only purpose is to reduce emissions or whose failure will increase emissions without significantly degrading engine/equipment performance.

### **Limited Applicability**

As a certifying manufacturer, BRP may deny emission-related warranty claims for failures that have been caused by the owner's or operator's improper maintenance or use, by accidents for which the manufacturer has no responsibility, or by acts of God. For example, an emission-related warranty claim need not be honored for failures that have been directly caused by the operator's abuse of the engine/equipment or the operator's use of the engine/equipment in a manner for which it was not designed and are not attributable to the manufacturer in anyway.



If you have any question regarding your warranty rights and responsibility or for the name and location of the nearest authorized BRP dealer, you should contact BRP by filling out the customer contact form at [www.brp.com](http://www.brp.com) or contact BRP by mail at one of the addresses listed under the CONTACT US section of this guide, or call at 1-888-272-9222.

---

# CALIFORNIA EVAPORATIVE EMISSIONS CONTROL WARRANTY STATEMENT

The warranty periods begin on the date the new Off-Highway Recreational Vehicle ("OHRV") is delivered to an ultimate purchaser.

Bombardier Recreational Products Inc. ("BRP") warrants to the ultimate purchaser and each subsequent purchaser that the OHRV is:

1. Designed, built, and equipped so as to conform, at the time of sale, with all applicable laws, rules and regulations; and
2. Free from defects in materials and workmanship that may cause the failure of a warranted part. All replacement parts must be identical in all material respects to that part as described in BRP's Executive Order of Certification application.

The warranty on emissions-related parts function as follows:

1. Repair or replacement of any warranted part must be performed at no charge to the OHRV owner, at a warranty station, except in the case of a temporary repair when a warranted part or a warranty station is not reasonably available to the OHRV owner. In the event a temporary repair is permitted, repairs may be performed at any available service establishment, or by the owner, using any replacement part. BRP must reimburse the owner for his or her expenses including diagnostic charges for such temporary repair or replacement, not to exceed BRP's suggested retail price for all warranted parts replaced and labor charges based on BRP's recommended time allowance for the warranty repair and the geographically appropriate hourly labor rate.
2. The lack of availability of warranted parts or the incompleteness of repairs within a reasonable time period, not to exceed 30 days from the time the OHRV is initially presented to the warranty station for repair, will qualify the need for a temporary repair.
3. Any warranted part which is not scheduled for replacement as part of maintenance in the written instructions must be warranted for the warranty period defined below. If any such part fails during the warranty period, it must be repaired or replaced by BRP. Any such part repaired or replaced under warranty must be fully warranted.
4. Any warranted part which is scheduled only for regular inspection in the written instructions must be warranted for the warranty period defined below. A statement in such written instructions to the effect of "repair or replace as necessary" does not reduce the period of warranty coverage. Any such part repaired or replaced under warranty is warranted for the remaining warranty period.
5. Any warranted part which is scheduled for replacement as part of maintenance in the written instructions is warranted for the period of time prior to the first scheduled replacement point for that part. If the part fails before the first scheduled replacement point, the part will be repaired or replaced by BRP. Any such part repaired or replaced under warranty is warranted for the remainder of the period prior to the first scheduled replacement point for the part.
6. Warranty services or repairs are provided at all manufacturer dealerships that are owned by the manufacturer or franchised to service the subject OHRVs.
7. The OHRV owner will not be charged for diagnostic labor which leads to the determination that a warranted part is, in fact, defective, provided that such diagnostic work is performed at a warranty station.

8. BRP is liable for damages to other vehicle components proximately caused by a failure, under warranty, of any warranted part.
9. Any replacement part designated by BRP may be used in warranty repairs provided without charge to the OHRV owner. Such use will not reduce the warranty obligations of BRP, except that BRP will not be liable for repair or replacement of any replacement part which is not a warranted part.
10. Any add-on or modified part exempted by the Air Resources Board from the prohibitions of section 27156 of the California Vehicle Code may be used on an OHRV. Such use, in and of itself, will not be grounds for disallowing a warranty claim. BRP is not liable to warrant failures of warranted parts caused by the use of an add-on or modified part (s) unless such part (s) are also warranted.

Conditions and exclusions:

- BRP may deny you warranty coverage if your OHRV or a part has failed directly due to abuse, neglect, improper maintenance or unapproved modifications.

## Your Warranty Rights And Obligations

The California Air Resources Board is pleased to explain the evaporative emissions control system warranty on your 2022 Off-Road Sport Vehicle. In California, new off-highway recreational vehicles must be designed, built, and equipped to meet the State's stringent anti-smog standards. BRP must warrant the evaporative emissions control system on your Off-Road Sport Vehicle for the periods of time listed below provided there has been no abuse, neglect, improper maintenance, or unapproved modification of your Off-Road Sport Vehicle.

Your evaporative emissions control system may include parts such as the carburetor or fuel-injection system, fuel tank, fuel hoses, carbon canister, and engine computer. Also included may be hoses, belts, connectors and other evaporative emissions-related assemblies. Where a warrantable condition exists, Bombardier Recreational Products Inc. will repair your Off-Road Sport Vehicle at no cost to you including diagnosis, parts and labor.

## OHRV Manufacturer's Warranty Coverage

The warranty period for this OHRV is 60 months, or 5000 miles, or 500 hours, whichever comes first.

Parts covered:

1. Canister Mounting Bracket(s)
2. Carbon Canister
3. Purge Port Connector
4. Clamp(s)\*
5. Electronic Control\*
6. Fuel Cap
7. Filler Neck
8. Filler Neck Hose
9. Fuel Line(s)
10. Fuel Line Fitting(s)
11. Fuel Tank
12. Pressure Relief Valve(s)\*

13. Purge Valve(s)
14. Check Valve(s)\*
15. Vapor Hose(s)
16. Flow Reducer
17. Filter(s)\*
18. All other parts not listed that may affect the evaporative emissions control system

**NOTE:** \*As related to the evaporative emission control system.

If any evaporative emissions-related part on your Off-Road Sport Vehicle is defective the part will be repaired or replaced by Bombardier Recreational Products Inc.

## **Owner's Warranty Responsibilities**

As the Off-Road Sport Vehicle owner you are responsible for the performance of the required maintenance listed in your owner's manual. Bombardier Recreational Products Inc. recommends that you retain all receipts covering maintenance on your Off-Road Sport Vehicle, but Bombardier Recreational Products Inc. cannot deny warranty solely for the lack of receipts or for failure to ensure the performance of a scheduled maintenance.

As an owner you are responsible for presenting your Off-Road Sport Vehicle to a Bombardier Recreational Products Inc. dealer as soon as a problem exists. The warranty repairs should be completed in a reasonable time, not to exceed 30 days.

As an Off-Road Sport Vehicle owner, you should also be aware that Bombardier Recreational Products Inc. may deny you warranty coverage if your Off-Road Sport Vehicle or a part has failed due to abuse, neglect, improper maintenance or unapproved modifications.

If you have any questions regarding your warranty rights and responsibilities, you should contact:

- Bombardier Recreational Products Inc. at 1-888-272-9222, or
- The California Air Resources Board at 9528 Telstar Avenue, El Monte, CA 91731.

---

# **BRP INTERNATIONAL LIMITED WARRANTY: 2022 CAN-AM® SSV**

## **1) SCOPE OF THE LIMITED WARRANTY**

Bombardier Recreational Products Inc. (“BRP”) warrants its 2022 Can-Am SSV sold by Can-Am SSV distributors or dealers authorized by BRP to distribute Can-Am SSVs (“Can-Am SSV Distributor/Dealer”) outside of the fifty United States, Canada, member states of the European Economic Area (which is comprised of the member states of the European Union plus the United Kingdom, Norway, Iceland and Liechtenstein) (“EEA”), member states of the Commonwealth of the Independent States (including Ukraine and Turkmenistan) (“CIS”) and Turkey, from defects in material or workmanship for the period and under the conditions described below.

Non-factory installed parts and accessories are not covered under this limited warranty. Please refer to the applicable parts and accessories limited warranty text.

This limited warranty will become null and void if:

1. The SSV was used for racing or any other competitive activity, at any point, even by a previous owner; or
2. The SSV has been altered or modified in such a way so as to adversely affect its operation, performance or durability, or has been altered or modified to change its intended use.

## **2) LIMITATIONS OF LIABILITY**

**TO THE EXTENT PERMITTED BY LAW, THIS WARRANTY IS EXPRESSLY GIVEN AND ACCEPTED IN LIEU OF ANY AND ALL OTHER WARRANTIES, EXPRESSED OR IMPLIED, INCLUDING WITHOUT LIMITATION ANY WARRANTY OF MERCHANTABILITY OR FITNESS FOR A PARTICULAR PURPOSE. TO THE EXTENT THAT THEY CANNOT BE DISCLAIMED, THE IMPLIED WARRANTIES ARE LIMITED IN DURATION TO THE LIFE OF THE EXPRESS WARRANTY. INCIDENTAL AND CONSEQUENTIAL DAMAGES ARE EXCLUDED FROM COVERAGE UNDER THIS WARRANTY. SOME JURISDICTIONS DO NOT ALLOW FOR THE DISCLAIMERS, LIMITATIONS AND EXCLUSIONS IDENTIFIED ABOVE, AS A RESULT, THEY MAY NOT APPLY TO YOU. THIS WARRANTY GIVES YOU SPECIFIC RIGHTS, AND YOU MAY ALSO HAVE OTHER LEGAL RIGHTS WHICH MAY VARY FROM COUNTRY TO COUNTRY. (FOR PRODUCTS PURCHASED IN AUSTRALIA SEE CLAUSE 4 BELOW).**

Neither the Can-Am SSV Distributor/Dealer nor any other person has been authorized to make any affirmation, representation or warranty regarding the product, other than those contained in this limited warranty, and if made, shall not be enforceable against BRP.

BRP reserves the right to modify this warranty at any time, being understood that such modification will not alter the warranty conditions applicable to the products sold while this warranty is in effect.

## **3) EXCLUSIONS ARE NOT WARRANTED**

The following are not warranted under this limited warranty under any circumstances:

- Normal wear and tear;
- Routine maintenance items, tune ups, adjustments (parts and labor);
- Damage caused by negligence or failure to provide proper maintenance and/or storage, as described in the Operator's Guide;
- Damage resulting from removal of parts, improper repairs, service, maintenance, modifications or use of parts not manufactured or approved by BRP or resulting from repairs done by a person that is not an authorized servicing Can-Am SSV Distributor/Dealer;
- Damage caused by abuse, abnormal use, neglect or operation of the product in a manner inconsistent with the recommended operation described in the Operator's Guide;
- Damage resulting from accident, submersion, fire, theft, vandalism or any act of God;
- Operation with fuels, oils or lubricants which are not suitable for use with the product (see the Operator's Guide);
- Damage resulting from rust, corrosion or exposure to the elements;
- Damage resulting from water or snow ingestion;
- Incidental or consequential damages, or damages of any kind including without limitation towing, transportation expenses, storage, telephone, rental, taxi, inconvenience, insurance coverage, loan payments, loss of time, loss of income or time missed for downtime experience due to service work.

The following list includes, without limitation, items that are considered wear items and that are not covered under BRP's limited warranty unless failure is a direct result of a defect in material or workmanship:

- Batteries
- Brake pads
- Brake disks and drums
- Clutch plates / pads
- Clutch sliders
- Clutch springs
- Clutch replaceable bushings
- Drive belts
- Filters
- Finished and unfinished surfaces
- Fuses
- Light bulbs / sealed
- Lubricants
- Spark plugs
- Suspension bushings
- Suspension slider shoes
- Suspension springs
- Tires

#### **4) Warranty Coverage Period**

This warranty will be in effect from (1) the date of delivery to the first retail consumer or (2) the date the product is first put into use, whichever occurs first and for a period of:

- SIX (6) CONSECUTIVE MONTHS for private use or commercial use.

In AUSTRALIA and NEW-ZEALAND only, this warranty will be in effect from (1) the date of delivery to the first retail consumer or (2) the date the product is first put into use, whichever occurs first and for a period of:

- TWENTY-FOUR (24) CONSECUTIVE MONTHS, or
- A total use of FIFTEEN THOUSAND (15 000) kilometers, whichever occurs first, for private use or commercial use.

The repair or replacement of parts or the performance of service under this warranty does not extend the life of this warranty beyond its original expiration date.

### **FOR PRODUCTS SOLD IN AUSTRALIA ONLY**

Nothing in these Warranty terms and conditions should be taken to exclude, restrict or modify the application of any condition, warranty, guarantee, right or remedy conferred or implied under the Competition and Consumer Act 2010 (Cth), including the Australian Consumer Law or any other law, where to do so would contravene that law, or cause any part of these terms and conditions to be void. The benefits given to you under this limited warranty hereto are in addition to other rights and remedies that you have under Australian law.

Our goods come with guarantees that cannot be excluded under the Australian Consumer Law. You are entitled to a replacement or refund for a major failure and for compensation for any other reasonably foreseeable loss or damage. You are also entitled to have the goods repaired or replaced if the goods fail to be of acceptable quality and the failure does not amount to a major failure.

## **5) CONDITIONS TO HAVE WARRANTY COVERAGE**

This warranty coverage is available **only** if **each** of the following conditions has been fulfilled:

- The 2022 Can-Am SSV must be purchased as new and unused by its first owner from a Can-Am SSV Distributor/Dealer authorized to distribute Can-Am SSVs in the country in which the sale occurred;
- The BRP specified pre-delivery inspection process must be completed and documented;
- The product must have undergone proper registration by an authorized Can-Am SSV Distributor/Dealer;
- The 2022 Can-Am SSV must be purchased in the country or union of countries in which the purchaser resides; and
- Routine maintenance outlined in the Operator's Guide must be timely performed in order to maintain warranty coverage. BRP reserves the right to make warranty coverage contingent upon proof of proper maintenance.

BRP will not honor this limited warranty to any private use owner or commercial use owner if one of the preceding conditions has not been met. Such limitations are necessary in order to allow BRP to preserve both the safety of its products, and also that of its consumers and the general public.

## **6) WHAT TO DO TO OBTAIN WARRANTY COVERAGE**

The customer must cease using the SSV upon the appearance of an anomaly. The customer must notify a servicing Can-Am SSV Distributor/Dealer within two (2) days of the appearance of a defect, and provide it with reasonable access to the product and reasonable opportunity to repair it. The customer must also

present to the authorized Can-Am SSV Distributor/Dealer proof of purchase of the product and must sign the repair/work order prior to starting the repair in order to validate the warranty repair. All parts replaced under this limited warranty become the property of BRP.

Note that the notification period is subject to the applicable national or local legislation in customer's country.

## **7) WHAT BRP WILL DO**

To the extent permitted by law, BRP's obligations under this warranty are limited to, at its sole discretion, repairing parts found defective under normal use, maintenance and service; or replacing such parts with new genuine Can-Am SSV parts without charge for parts and labour, at any authorized Can-Am SSV Distributor/ Dealer during the warranty coverage period under the conditions described herein. BRP's responsibility is limited to making the required repairs or replacements of parts. No claim of breach of warranty shall be cause for cancellation or rescission of the sale of the Can-Am SSV to the owner. You may have other legal rights which may vary from country to country.

In the event that service is required outside of the country of original sale, the owner will bear responsibility for any additional charges due to local practices and conditions, such as, but not limited to, freight, insurance, taxes, license fees, import duties, and any and all other financial charges, including those levied by governments, states, territories and their respective agencies.

BRP reserves the right to improve or modify products from time to time without assuming any obligation to modify products previously manufactured.

## **8) TRANSFER**

If the ownership of a product is transferred during the warranty coverage period, this limited warranty, subject to its terms and conditions, shall also be transferred and be valid for the remaining coverage period provided BRP or an authorized Can-Am SSV Distributor/Dealer receives a proof that the former owner agreed to the transfer of ownership, in addition to the coordinates of the new owner.

## **9) CONSUMER ASSISTANCE**

In the event of a controversy or a dispute in connection with this limited warranty, BRP suggests that you try to resolve the issue at the Can-Am SSV Distributor/ Dealer level. We recommend discussing the issue with the authorized Can-Am SSV Distributor/Dealer's service manager or owner.

If the matter still remains unresolved, contact BRP by filling out the customer contact form at [www.brp.com](http://www.brp.com) or contact BRP by mail at one of the addresses listed under the *Contact Us* section of this guide.



---

# **BRP LIMITED WARRANTY FOR THE EUROPEAN ECONOMIC AREA, THE COMMONWEALTH OF THE INDEPENDENT STATES AND TURKEY: 2022 CAN-AM® SSV**

## **1) SCOPE OF THE LIMITED WARRANTY**

Bombardier Recreational Products Inc. (“BRP”) warrants its 2022 Can-Am SSVs sold by Can-Am SSV distributors or dealers authorized by BRP to distribute Can-Am SSVs (“Can-Am SSV Distributor/Dealer”) in member states of the European Economic Area (which is comprised of the member states of the European Union plus the United Kingdom, Norway, Iceland and Liechtenstein) (“EEA”), in member states of the Commonwealth of the Independent States (including Ukraine and Turkmenistan) (“CIS”) and Turkey from defects in material or workmanship for the period and under the conditions described below.

Non-factory installed parts and accessories are not covered under this limited warranty. Please refer to the applicable parts and accessories limited warranty text.

This limited warranty will become null and void if:

1. The SSV was used for racing or any other competitive activity, at any point, even by a previous owner; or
2. The SSV has been altered or modified in such a way so as to adversely affect its operation, performance or durability, or has been altered or modified to change its intended use.

## **2) LIMITATIONS OF LIABILITY**

**TO THE EXTENT PERMITTED BY LAW, THIS WARRANTY IS EXPRESSLY GIVEN AND ACCEPTED IN LIEU OF ANY AND ALL OTHER WARRANTIES, EXPRESSED OR IMPLIED, INCLUDING WITHOUT LIMITATION ANY WARRANTY OF MERCHANTABILITY OR FITNESS FOR A PARTICULAR PURPOSE. TO THE EXTENT THAT THEY CANNOT BE DISCLAIMED, THE IMPLIED WARRANTIES ARE LIMITED IN DURATION TO THE LIFE OF THE EXPRESS WARRANTY. INCIDENTAL AND CONSEQUENTIAL DAMAGES ARE EXCLUDED FROM COVERAGE UNDER THIS WARRANTY. SOME JURISDICTIONS DO NOT ALLOW FOR THE DISCLAIMERS, LIMITATIONS AND EXCLUSIONS IDENTIFIED ABOVE, AS A RESULT, THEY MAY NOT APPLY TO YOU. THIS WARRANTY GIVES YOU SPECIFIC RIGHTS, AND YOU MAY ALSO HAVE OTHER LEGAL RIGHTS WHICH MAY VARY FROM COUNTRY TO COUNTRY.**

Neither the Can-Am SSV Distributor/Dealer nor any other person has been authorized to make any affirmation, representation or warranty regarding the product, other than those contained in this limited warranty, and if made, shall not be enforceable against BRP.

BRP reserves the right to modify this warranty at any time, being understood that such modification will not alter the warranty conditions applicable to the products sold while this warranty is in effect.

### **3) EXCLUSIONS – ARE NOT WARRANTED**

The following are not warranted under this limited warranty under any circumstances:

- Normal wear and tear;
- Routine maintenance items, tune ups, adjustments (parts and labor);
- Damage caused by negligence or failure to provide proper maintenance and/or storage, as described in the Operator's Guide;
- Damage resulting from removal of parts, improper repairs, service, maintenance, modifications or use of parts not manufactured or approved by BRP or resulting from repairs done by a person that is not an authorized servicing Can-Am SSV Distributor/Dealer;
- Damage caused by abuse, abnormal use, neglect or operation of the product in a manner inconsistent with the recommended operation described in the Operator's Guide;
- Damage resulting from accident, submersion, fire, snow or water ingestion, theft, vandalism or any act of God;
- Operation with fuels, oils or lubricants which are not suitable for use with the product (see the Operator's Guide);
- Damage resulting from rust, corrosion or exposure to the elements;
- Incidental or consequential damages, or damages of any kind including without limitation towing, transportation expenses, storage, telephone, rental, taxi, inconvenience, insurance coverage, loan payments, loss of time, loss of income or time missed for downtime experience due to service work.

The following list includes, without limitation, items that are considered wear items and that are not covered under BRP's limited warranty unless failure is a direct result of a defect in material or workmanship:

- Batteries
- Brake pads
- Brake disks and drums
- Clutch plates / pads
- Clutch sliders
- Clutch springs
- Clutch replaceable bushings
- Drive belts
- Filters
- Finished and unfinished surfaces
- Fuses
- Light bulbs / sealed
- Lubricants
- Spark plugs
- Suspension bushings
- Suspension slider shoes
- Suspension springs
- Tires

### **4) WARRANTY COVERAGE PERIOD**

This warranty will be in effect from (1) the date of delivery to the first retail consumer or (2) the date the product is first put into use, whichever occurs first and for a period of:

- TWENTY-FOUR (24) CONSECUTIVE MONTHS for private use.
- SIX (6) CONSECUTIVE MONTHS for commercial use or rental use.

The product is used commercially when it is used in connection with any work or employment that generates income during any part of the warranty period. The product is also used commercially when, at any point during the warranty period, it is licensed for commercial use.

The repair or replacement of parts or the performance of service under this warranty does not extend the life of this warranty beyond its original expiration date.

Note that the duration and any other modalities of the warranty coverage are subject to the applicable national or local legislation in your country.

## 5) CONDITIONS TO HAVE WARRANTY COVERAGE

This warranty coverage is available **only** if **each** of the following conditions has been fulfilled:

- The 2022 Can-Am SSV must be purchased as new and unused by its first owner from a Can-Am SSV Distributor/Dealer authorized to distribute Can-Am SSVs in the country in which the sale occurred;
- The BRP specified pre-delivery inspection process must be completed and documented;
- The product must have undergone proper registration by an authorized Can-Am SSV Distributor/Dealer;
- The 2022 Can-Am SSV must be purchased in the country or union of countries in which the purchaser resides; and
- Routine maintenance outlined in the Operator's Guide must be timely performed in order to maintain warranty coverage. BRP reserves the right to make warranty coverage contingent upon proof of proper maintenance.

BRP will not honor this limited warranty to any private use owner or commercial use owner if one of the preceding conditions has not been met. Such limitations are necessary in order to allow BRP to preserve both the safety of its products, and also that of its consumers and the general public.

## 6) WHAT TO DO TO OBTAIN WARRANTY COVERAGE

The customer must cease using the SSV upon the appearance of an anomaly. The customer must notify a servicing Can-Am SSV Distributor/Dealer within two (2) months of the appearance of a defect and provide it with reasonable access to the product and reasonable opportunity to repair it. The customer must also present to the authorized Can-Am SSV Distributor/Dealer, proof of purchase of the product and must sign the repair/work order prior to starting the repair in order to validate the warranty repair. All parts replaced under this limited warranty become the property of BRP.

Note that the notification period is subject to the applicable national or local legislation in your country.

## 7) WHAT BRP WILL DO

To the extent permitted by law, BRP's obligations under this warranty are limited to, at its sole discretion, repairing parts found defective under normal use,

maintenance and service, or replacing such parts with new genuine Can-Am SSV parts without charge for parts and labor, at any authorized Can-Am SSV Distributor/ Dealer during the warranty coverage period under the conditions described herein. BRP's responsibility is limited to making the required repairs or replacements of parts. No claim of breach of warranty shall be cause for cancellation or rescission of the sale of the Can-Am SSV to the owner. You may have other legal rights which may vary from country to country.

In the event that service is required outside of the EEA, the owner will bear responsibility for any additional charges due to local practices and conditions, such as, but not limited to, freight, insurance, taxes, license fees, import duties, and any and all other financial charges, including those levied by governments, states, territories and their respective agencies.

BRP reserves the right to improve or modify products from time to time without assuming any obligation to modify products previously manufactured.

## **8) TRANSFER**

If the ownership of a product is transferred during the warranty coverage period, this warranty shall also be transferred and be valid for the remaining coverage period provided BRP or an authorized Can-Am SSV Distributor/Dealer receives a proof that the former owner agreed to the transfer of ownership, in addition to the co-ordinates of the new owner.

## **9) CONSUMER ASSISTANCE**

In the event of a controversy or a dispute in connection with this limited warranty, BRP suggests that you try to resolve the issue at the Can-Am SSV Distributor/ Dealer level. We recommend discussing the issue with the authorized Can-Am SSV Distributor/Dealer's service manager or owner.

If the matter still remains unresolved, contact BRP by filling out the customer contact form at [www.brp.com](http://www.brp.com) or contact BRP by mail at one of the addresses listed under the *Contact Us* section of this guide.

**ADDITIONAL TERMS AND CONDITIONS FOR FRANCE ONLY**

The following terms and conditions are applicable to products sold in France only:

The seller shall deliver goods that are complying with the contract and shall be responsible for defects existing upon delivery. The seller shall also be responsible for defects resulting from packaging, assembling instructions or the installation when it is its responsibility per the contract or if accomplished under its responsibility. To be compliant with the contract, the good shall:

1. Be fit for normal use for goods similar thereto and, if applicable:
  - Correspond to the description provided by the seller and have the qualities presented to the buyer though sample or model;
  - Have the qualities that a buyer may legitimately expect considering the public declarations of the seller, the manufacturer of its representative, including in advertising or labeling; or
2. Have the characteristics mutually agreed upon as between the parties or be fit for the specific use intended by the buyer and brought to the attention of the seller and which accepted.

The action for failure to comply is prescribed after two years after delivery of the goods. The seller is responsible for the warranty for hidden defects of the goods sold if such hidden defects are rendering the good unfit for the intended use, or if they diminish its use in such a way that the buyer would not have acquired the good or would have given a lesser price, had he known. The action for such hidden defects shall be taken by the buyer within 2 years of the discovery of the defect.

# MAINTENANCE RECORDS

Send photocopy of maintenance record to BRP if needed.

Pre-delivery	
Serial number: _____ Mileage / km: _____ Hours: _____ Date: _____ Dealer no: _____ Notes: _____ _____	Signature/Print:
Refer to vehicle Pre-Delivery Bulletin for detailed installation procedures	

FIRST inspection	
Mileage / km: _____ Hours: _____ Date: _____ Dealer no: _____ Notes: _____ _____	Signature/Print:
For maintenance schedule refer to Maintenance Information section of this operator's guide	

Service	
Mileage / km: _____ Hours: _____ Date: _____ Dealer no: _____ Notes: _____ _____	Signature/Print:
For maintenance schedule refer to Maintenance Information section of this operator's guide	

<b>Service</b>	
Mileage / km: _____ Hours: _____ Date: _____ Dealer no: _____ Notes: _____ _____	Signature/Print: _____     
For maintenance schedule refer to Maintenance Information section of this operator's guide	

<b>Service</b>	
Mileage / km: _____ Hours: _____ Date: _____ Dealer no: _____ Notes: _____ _____	Signature/Print: _____     
For maintenance schedule refer to Maintenance Information section of this operator's guide	

<b>Service</b>	
Mileage / km: _____ Hours: _____ Date: _____ Dealer no: _____ Notes: _____ _____	Signature/Print: _____     
For maintenance schedule refer to Maintenance Information section of this operator's guide	

**Service**

Mileage / km: \_\_\_\_\_

Hours: \_\_\_\_\_

Date: \_\_\_\_\_

Dealer no: \_\_\_\_\_

Notes: \_\_\_\_\_

Signature/Print: \_\_\_\_\_

For maintenance schedule refer to Maintenance Information section of this operator's guide

**Service**

Mileage / km: \_\_\_\_\_

Hours: \_\_\_\_\_

Date: \_\_\_\_\_

Dealer no: \_\_\_\_\_

Notes: \_\_\_\_\_

Signature/Print: \_\_\_\_\_

For maintenance schedule refer to Maintenance Information section of this operator's guide

**Service**

Mileage / km: \_\_\_\_\_

Hours: \_\_\_\_\_

Date: \_\_\_\_\_

Dealer no: \_\_\_\_\_

Notes: \_\_\_\_\_

Signature/Print: \_\_\_\_\_

For maintenance schedule refer to Maintenance Information section of this operator's guide



<b>Service</b>	
Mileage / km: _____ Hours: _____ Date: _____ Dealer no: _____ Notes: _____ _____	Signature/Print: _____     
For maintenance schedule refer to Maintenance Information section of this operator's guide	

<b>Service</b>	
Mileage / km: _____ Hours: _____ Date: _____ Dealer no: _____ Notes: _____ _____	Signature/Print: _____     
For maintenance schedule refer to Maintenance Information section of this operator's guide	

<b>Service</b>	
Mileage / km: _____ Hours: _____ Date: _____ Dealer no: _____ Notes: _____ _____	Signature/Print: _____     
For maintenance schedule refer to Maintenance Information section of this operator's guide	

**Service**

Mileage / km:

Hours:

Date:

Dealer no:

Notes:

Signature/Print:

For maintenance schedule refer to Maintenance Information section of this operator's guide

**Service**

Mileage / km:

Hours:

Date:

Dealer no:

Notes:

Signature/Print:

For maintenance schedule refer to Maintenance Information section of this operator's guide

**Service**

Mileage / km:

Hours:

Date:

Dealer no:

Notes:

Signature/Print:

For maintenance schedule refer to Maintenance Information section of this operator's guide

# **CUSTOMER INFORMATION**

---

## PRIVACY INFORMATION

BRP wishes to inform you that your coordinates will be used for safety and warranty related purposes. Furthermore, BRP and its affiliates may use its customer list to distribute marketing and promotional information about BRP and related products.

To exercise your right to consult or correct your data, or to be removed from the addressee-list for direct marketing, please contact BRP.

By E-mail:  
privacyofficer@brp.com

By mail:  
BRP Legal Service  
726 St-Joseph  
Valcourt QC  
Canada  
J0E 2L0

---

# CONTACT US

www.brp.com

## Asia

Room 4609, Tower 2,  
Grand Gateway 3 Hong Qiao  
Road Shanghai,  
China 200020

21F Shinagawa East One Tower  
2-16-1 Konan, Minatoku-ku,  
Tokyo 108-0075  
Japan

## Europe

Oktrooiplein 1/402  
9000 Gent  
Belgium

Itterpark 11  
D-40724 Hilden  
Germany

ARTEPARC Bâtiment B  
Route de la côte d'Azur, Le Canet  
13590 Meyreuil  
France

Ingvald Ystgaardsvei 15  
N-7484 Trondheim  
Norway

Isoaavantie 7  
PL 8040  
96101 Rovaniemi

Spinnvägen 15  
903 61 Umeå  
Sweden

Avenue d'Ouchy 4-6  
1006 Lausanne  
Switzerland

## North America

565 de la Montagne Street  
Valcourt (Québec) J0E 2L0  
Canada

Sa De Cv, Av. Ferrocarril 202  
Parque Ind. Querétaro, Lote2-B  
76220  
Santa Rosa Jáuregui, Qro., Mexico

Sturtevant, Wisconsin, U.S.A.

10101 Science Drive  
Sturtevant, Wisconsin  
53177  
U.S.A.

## Oceania

6 Lord Street  
Lakes Business Park  
Botany, NSW 2019  
Australia

3B Echelon Place, East Tamaki,  
Auckland 2013,  
New Zealand

## South America

Rua James Clerck Maxwell, 230  
TechnoPark Campinas SP 13069-380  
Brazil

---

## CHANGE OF ADDRESS AND OWNERSHIP

If your address has changed or if you are the new owner of the vehicle, be sure to notify BRP by either:

- Notifying an authorized Can-Am dealer.
- **North America Only:** calling at 1 888 272-9222.
- Mailing one of the change of address cards on the following pages at one of the BRP addresses indicated in the *Contact Us* section of this guide.

In case of change of ownership, please join a proof that the former owner agreed to the transfer.

Notifying BRP, even after the expiration of the limited warranty, is very important as it enables BRP to reach the vehicle owner if necessary, like when safety recalls are initiated. It is the owner's responsibility to notify BRP.

**STOLEN UNITS:** If your personal vehicle is stolen, you should notify BRP or an authorized Can-Am dealer. We will ask you to provide your name, address, phone number, the vehicle identification number and the date it was stolen.



This page is  
intentionally blank



CHANGE OF ADDRESS <input type="checkbox"/>	CHANGE OF OWNERSHIP <input type="checkbox"/>	
VEHICLE IDENTIFICATION NUMBER		
Model Number	Vehicle Identification Number (V.I.N.)	
<b>OLD ADDRESS OR PREVIOUS OWNER:</b>	NAME	
	NO.	STREET
	APT	
	CITY	STATE/PROVINCE
	ZIP/POSTAL CODE	
	COUNTRY	TELEPHONE
<b>NEW ADDRESS OR NEW OWNER:</b>	NAME	
	NO.	STREET
	APT	
	CITY	STATE/PROVINCE
	ZIP/POSTAL CODE	
	COUNTRY	TELEPHONE
	E-MAIL ADDRESS	

CHANGE OF ADDRESS <input type="checkbox"/>	CHANGE OF OWNERSHIP <input type="checkbox"/>	
VEHICLE IDENTIFICATION NUMBER		
Model Number	Vehicle Identification Number (V.I.N.)	
<b>OLD ADDRESS OR PREVIOUS OWNER:</b>	NAME	
	NO.	STREET
	APT	
	CITY	STATE/PROVINCE
	ZIP/POSTAL CODE	
	COUNTRY	TELEPHONE
<b>NEW ADDRESS OR NEW OWNER:</b>	NAME	
	NO.	STREET
	APT	
	CITY	STATE/PROVINCE
	ZIP/POSTAL CODE	
	COUNTRY	TELEPHONE
	E-MAIL ADDRESS	

This page is  
intentionally blank























Model No. \_\_\_\_\_

**VEHICLE**

IDENTIFICATION NUMBER (V.I.N.) \_\_\_\_\_

**ENGINE**

IDENTIFICATION NUMBER (E.I.N.) \_\_\_\_\_

**Owner:** \_\_\_\_\_

NAME

No.

STREET

APT

CITY

STATE/PROVINCE

ZIP/POSTAL CODE

**Purchase Date** \_\_\_\_\_

YEAR

MONTH

DAY

**Warranty Expiry Date** \_\_\_\_\_

YEAR

MONTH

DAY

To be completed by the dealer at the time of the sale.

DEALER IMPRINT AREA

## **WARNING**

### **TO REDUCE RISK OF SERIOUS INJURY OR DEATH,**

- Read this operator's guide and safety labels
- Watch the safety video.



### **BE PREPARED**

- Fasten seat belts and make sure nets and/or doors are securely latched in place.
- Wear an approved helmet and protective gear.
- Each rider must be able to sit with back against seat, foot flat on the floor or on footrest, and hands on steering wheel or handholds. Stay completely inside the vehicle.

### **DRIVE RESPONSIBLY**

- Avoid loss of control and rollovers.
- Avoid abrupt maneuvers, sideways sliding, skidding or fishtailing and never do donuts.
- Avoid hard acceleration when turning, even from a stop.
- Slow down before entering a turn.
- Plan for hills, rough terrain, ruts and other changes in traction and terrain.
- Avoid paved surfaces.
- Avoid side hilling (riding across slopes).

### **BE QUALIFIED AND RESPONSIBLE**

- Do not allow careless or reckless driving.
- Driver must be at least 16 years old with a valid driver's license.
- Do not operate after using drugs or alcohol.
- Do not allow operation on public roads (unless designated for off-highway vehicle access) – collisions with cars and trucks can occur.
- Do not exceed vehicle seating capacity.

[www.brp.com](http://www.brp.com)

**SKI-DOO®**

**LYNX®**

**SEA-DOO®**

**EVINRUDE®**

**CAN-AM®**

**ROTAX®**

219002167