



## **Pro XP & Turbo R Paragon-43 280 Turbo Upgrade System**

**SKU(s): 604FP0049**

**NOTE: Expect 24–48-hour delay from the time you request a tune to when the file is enabled. Please create your Maptuner/CodeShooter account before starting the project. Email us at [maptunerx@evopowersports.com](mailto:maptunerx@evopowersports.com)**

This is a high-performance upgrade! Although we have gone through great lengths to build safety into the upgrade turbo system, the fact is installing any upgrade / turbo system requires care in both operation and installation. Poor fuel, improper setup or any number of things that are done incorrectly can damage your engine!

- You have likely voided the sound and exhaust emission standards of your country if applicable.
- This upgrade is intended for OFFROAD and RACING use only.
- This is a performance upgrade which will VOID your engine warranty especially if installed incorrectly or operated without regard to your instruments.
- The fuel requirements must be adhered to. Poor fuel can destroy an engine in seconds.
- Evolution Powersports bears no responsibility for damage caused to your vehicle by the installation of EVP products. The warranty on big turbo kits is 30 days from the date of purchase. Evolution Powersports, at its discretion will determine whether a part meets the warranty requirements. In no case is there any warranty from EVP for your vehicle or vehicles drivetrain. Although we have been careful to supply you with the highest quality parts possible, we assume no liability for damage to the vehicle or personal injury from installing or using any of our products.
- The installation of this kit is technical and mechanical in nature with many opportunities to make mistakes – mistakes that can be very costly. If you are not qualified to install this kit, bring your vehicle to one of our qualified installation centers to do the installation.
- This kit will make your vehicle faster, climb higher and accelerate more quickly and take a longer distance to brake than a stock tuned vehicle. If you are not capable of controlling the vehicle with the added performance, do not install the kit.
- High boost is hard on spark plugs – they must be changed frequently. If you experience misfire issues – Gap and replace the spark plugs.
- A full exhaust and clutching are required for this kit and can be purchased separately.
- Do not ever allow a child or an unqualified driver to operate this vehicle.



**Parts Included in Paragon 43-280 Turbo Upgrade System**

|           |   |
|-----------|---|
| 100FP0020 | XP Turbo/S & Pro XP & Turbo R Silicone Charge Tube Kit, Black               |
| 100FP0117 | XP Turbo/S & Pro XP & Turbo R Blow Off Valve 2.0 (BOV) Kit                  |
| 203FP0034 | Pro XP & Turbo R V-Flow Intake Kit, Black                                   |
| 500FP0013 | 2021+ Pro XP High Pressure Fuel Pump Kit                                    |
| 502FP0016 | XP Turbo/S / Pro XP 1700CC Injector Set of 2                                |
| 604FU0054 | 2019-2021 XP Turbo/S & Pro XP EVAP Paragon 43/42 Blue Turbocharger Assembly |
| 604FP0025 | Pro XP & Turbo R Paragon Install Kit  |
| 707FP0003 | Maptuner X for Polaris  |
| 800FP0001 | XP Turbo/S XR Series EVP Head Stud Kit                                      |
| 705FP0030 | RZR 4 Bar MAP Sensor Kit  |
| 804FP0169 | XP Turbo/S Spark Plug Set Of 2, Brisk                                       |
| 804FP0190 | Pro XP and Turbo R TPR Oil Breather Kit, Raw                                |

**Parts Included Pro XP/ Turbo R Paragon Install Kit**

|           |                                   |     |
|-----------|-----------------------------------|-----|
| 953RU0078 | Hps 3/8" Silicone Water Hose      | 7.5 |
| 953RU0078 | Hps 3/8" Silicone Water Hose      | 15  |
| 953RU0127 | 22mm Pinch Clamp                  | 4   |
| 953RU0197 | Reduction T 1/2" Barb x 3/8" Barb | 1   |
| 953RUXXXX | 3/4" to 5/8" Barb Reducer         | 1   |
| 953RU0150 | 3/4" Heater Hose                  | 3   |
| 953RU0151 | 30.1MM Pinch Clamp                | 2   |
| 001FU0133 | Paragon Maptuner Power Flash      | 1   |

| Level          | Tunes               | Max Boost (psi) | Spark Plug Gap | Spring       | Waste Gate (psi) | Engine HP |
|----------------|---------------------|-----------------|----------------|--------------|------------------|-----------|
| <b>P43-280</b> | 91, 100, MS109, E85 | 19, 25, 29, 29  | .016 - .018    | Brown/Purple | 8                | 280 (E85) |

**Required Parts (Sold Separately)**

|   |
|---|
| <ul style="list-style-type: none"> <li>• EVP or other Full Turbo Back Exhaust System</li> <li>• AFR Module</li> <li>• Boost Module</li> </ul> |
|---|

## TURBO REMOVAL

**Step 1:** Remove the bed (4) T40 torx, both seats (rear two seats in a four seater), both firewall panels.

**Step 2:** Remove the turbo and exhaust heat shields using a 10mm socket.



Figure 1

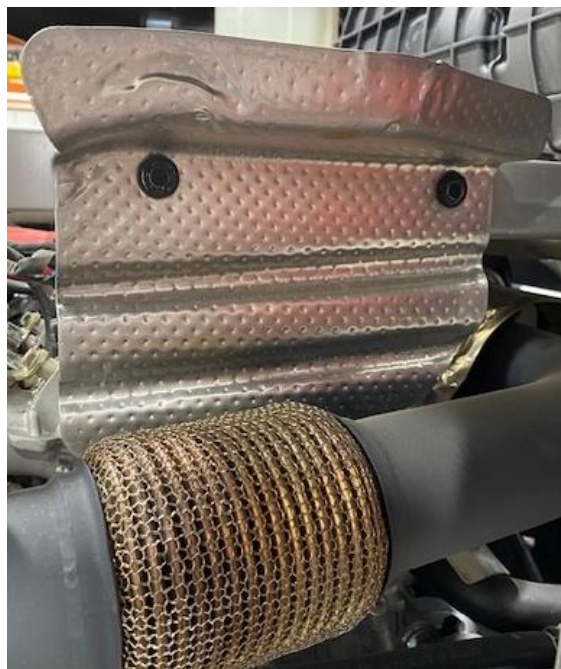

Figure 2

**Step 3:** Remove the charge tube using a 11mm socket to loosen both clamps on the turbocharger and throttle body. Disconnect the MAP sensor and blow off valve/ boost recirculating valve. (this vehicle already has an EVP charge tube and BOV).

**Step 4:** Remove the V-Flow using a 11mm socket to loosen both clamps on the turbocharger and airbox. Unplug the MAF sensor.

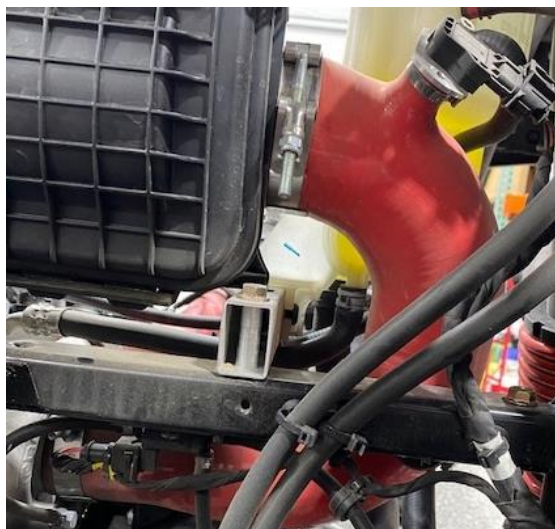

Figure 3

**Step 5:** Remove both upper and lower turbo heat shields using a 10mm socket.



Figure 4



Figure 5

**Step 6:** Spray the (4) screws holding the exhaust to the turbocharger with penetrating oil. Do this a minimum of three times while you continue working.



Figure 6

**Step 7:** Drain the coolant reservoir, first pull the pressure cap off releasing any built-up pressure. Pull the bottom left hose off and catch the coolant in a bucket.

**Step 8:** Remove the (4) M6 allen bolts holding the exhaust system to the turbocharger.

**Step 9:** Remove the turbocharger bracket. Remove the top bolts holding the bracket to the turbocharger. The 10mm head circled below has a 13mm nut on the back side. You will need a 13mm open end wrench. On the bottom of the turbocharger bracket you need to loosen (6) 15mm bolts. Only remove one bolt circled in red below on both sides.



Figure 7



Figure 8

**Step 10:** Remove the oil feed line from the turbocharger using a 13mm socket. Keep the banjo bolt and copper washers. Use a 15mm wrench to remove the spacer bolt holding the bracket to turbocharger.

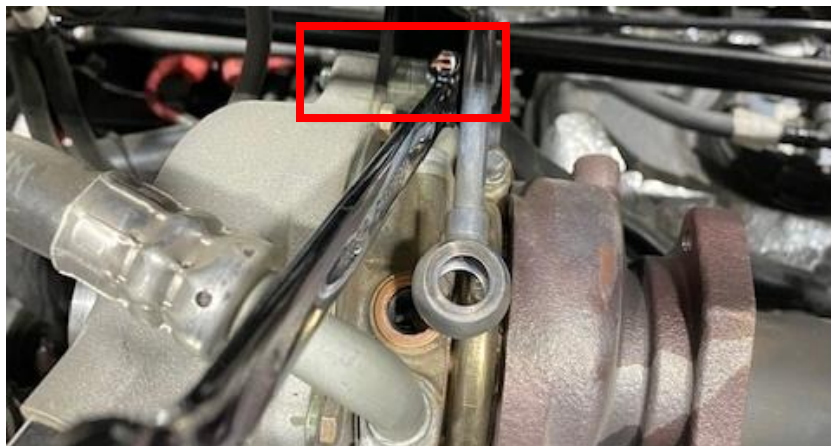

Figure 9

**Step 11:** Remove the oil feed line from the turbocharger bracket, use a T25 socket. Tilt the bracket towards the front of the vehicle and remove.

**Step 12:** Remove and label the **wastegate** and **boost reference** vacuum lines from the turbocharger.



Figure 10

**Step 13:** Pinch off the coolant lines going to the oil cooler. Below the “T” fitting. Remove the coolant line from the “T” going to the turbocharger. Keep the other end connected to turbo.

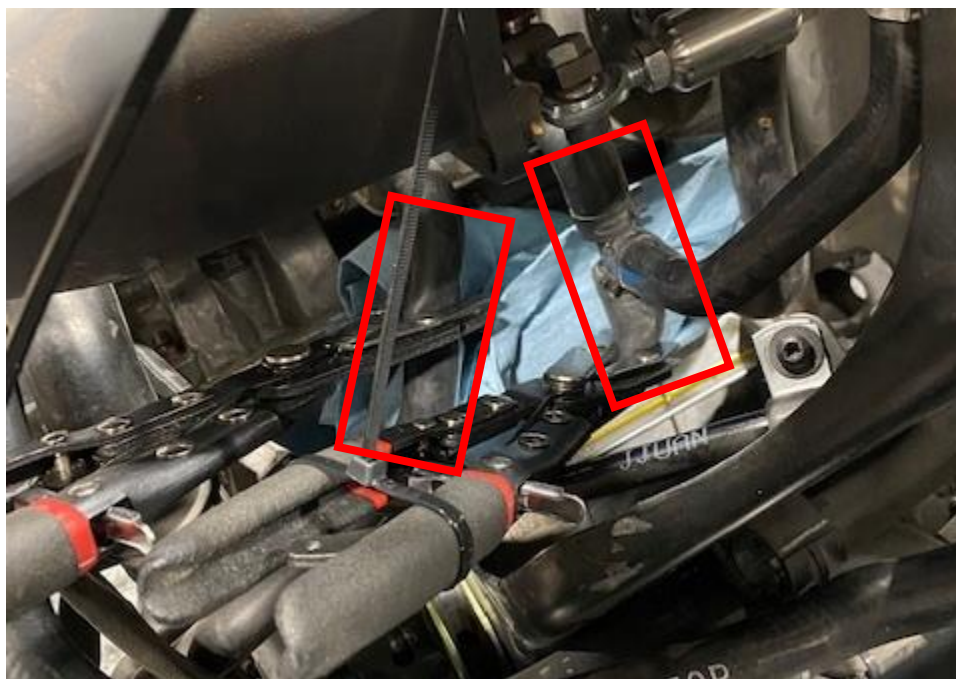

Figure 11

**Step 14:** Remove the oil drain hose from the oil drainpipe.

**Step 15:** Remove the coolant feed line from the reservoir to turbocharger. (Figure 12)

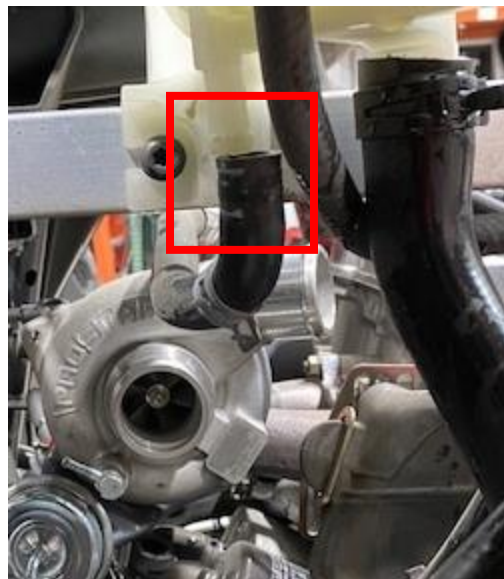

Figure 12

**Step 16:** Remove (4) 13mm nuts holding the turbocharger to the block. Remove (2) M6 Allen screws holding the turbocharger to the block. Remove turbocharger.



Figure 13

**Step 17:** With the new turbocharger on the bench, double check all shipping plugs are removed from the oil drain pipe and no debris in the turbine or compressor housings.

**Step 18:** Remove the OEM coolant “T” coming from the oil cooler and install supplied “T” fitting. Reuse the self-tightening clamps for the new barb.



Figure 14



**Step 20:** On the turbo support bracket, you will need to grind a larger radius around the top support hole. See photo below where the mark is located.



Figure 17



Figure 18

### ***Turbocharger Installation***

**Step 21:** Install the new turbocharger, if the head pipe gasket is damaged you must replace it. Torque specifications are below for turbo.



Torque nuts to 26 ft/lb (35Nm)



Torque screws to 17 ft/lb (23Nm)

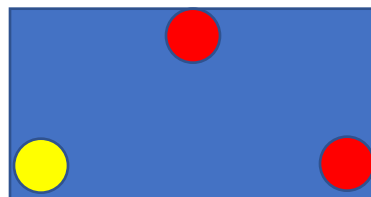
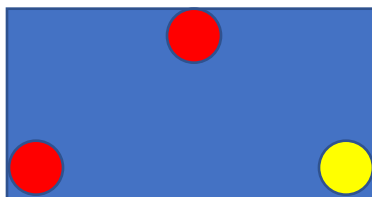

**Step 22:** Install the supplied 26.0" water hose line from the "J" coolant fitting by the wastegate and connect to the "T" fitting. Route the coolant hose clockwise around the turbocharger and down to the "T" fitting. Use pinch clamps to secure. Connect the OEM oil drain hose to the turbo.

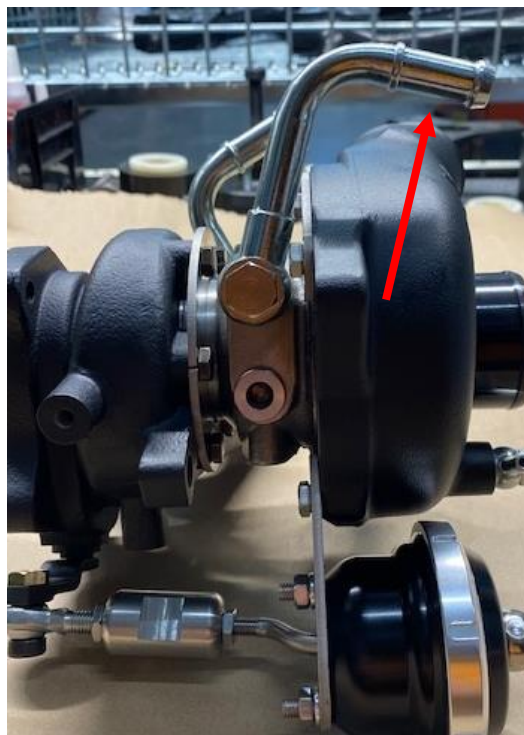

Figure 19

**Step 23:** Install the supplied 15.0" water hose line from the "J" coolant fitting to coolant reservoir tank. Use supplied 22mm pinch clamps to secure.



Figure 20

**Step 24:** Reinstall the turbocharger support bracket, push against the turbocharger making sure you ground enough off. Tighten the lower support bolts (42 ft/lbs) and reinstall top hardware. Screw in the spacer bolt using a 15mm wrench. Screw the 10mm head screw into the spacer bolt. Reinstall the turbo oil feed line reusing the banjo bolt and (2) copper washers. Torque banjo to 33 ft/lbs.



Figure 21



Figure 22

**Step 25:** Secure the oil feed line and coolant hoses to the turbocharger support bracket. Remove the coolant clamps from the vehicle.

**Step 26:** Reinstall the wastegate and boost reference vacuum hoses to the new turbocharger.

**Step 26:** Reinstall the 3.0" exhaust to the turbocharger. If the exhaust gasket is not useable, replace it. If you are installing new exhaust, please find those instructions on our website. Place anti seize on the threads and torque to 18 ft/lbs.

## Injector Removal

- Step 1:** With the engine cold, spray the injector valleys and fuel rail with parts cleaner. Use compressed air to finish. If you don't do this step and you remove the injectors, debris will fall into the engine and plenum.
- Step 2:** Remove the plastic safety retainer on the fuel rail. Remove the fuel line from the fuel rail (red arrow). Fuel may seep out of the fuel rail, and have rags close by.
- Step 3:** Remove the injector electrical adaptors (green arrow) and loosen the (2) fuel rail screws (yellow arrow). Remove the fuel rail with injectors attached.



Figure 23

- Step 4:** Remove the old injectors and place in a plastic bag. Use dielectric grease on the O-rings on the new injectors and slide into the fuel rail.



Figure 24

**Step 5:** Reinstall the fuel rail with supplied hardware. Place the spacers between the fuel rail and plenum. Torque down to 7 ft/lb. **NOTE:** the injectors will still move when torqued down, this is correct. They are sealed.



Figure 25

**Step 6:** Reinstall the fuel hose to the fuel rail. Make sure the fuel line is all the way on.



Figure 26

## Head Stud Installation

**Step 1:** Pinch off all coolant lines going to the engine and valve cover. Remove the coolant reservoir cap if you haven't done that already. Once all coolant lines are pinched off remove the valve cover coolant line. **NOTE:** there may be pressure behind this hose, cap the barb off with a silicone cap.



Figure 27



Figure 28



Figure 29

**Step 2:** Disconnect the spark plug coil packs and loosen the coil packs with a 8mm socket. Pull the coil packs out of the valve cover.

**Step 3:** Remove the (4) valve cover screws using a T-40 torxs. Keep the rubber gromets. Remove the valve cover and gasket.

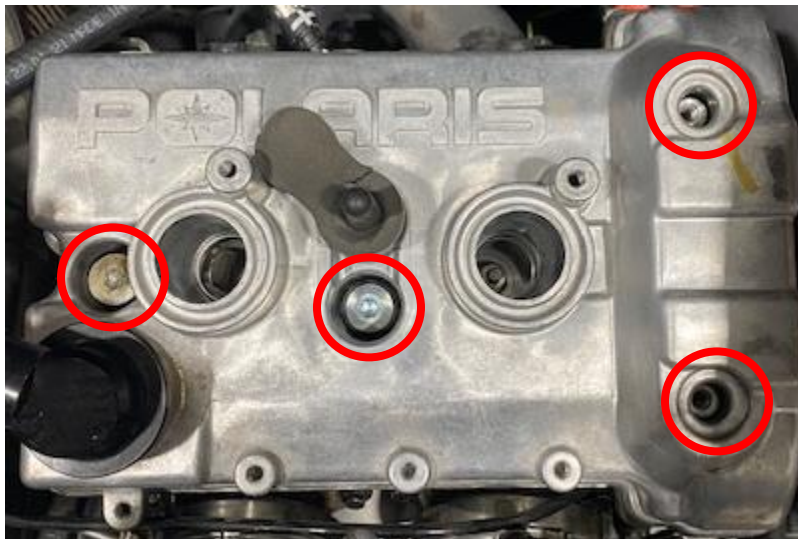

Figure 30

**Step 4:** Remove the crankcase position sensor using an 8mm socket. Find TDC and slide the cam locking tool into place. **Tool Number: PU-50563-1.** To double check TDC you can find a (+) sign looking through the crankcase position sensor port.

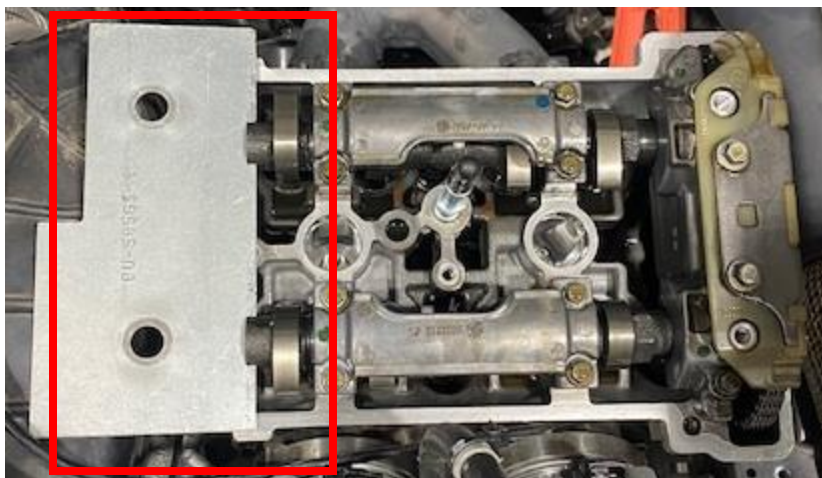

Figure 31



Figure 32

**Step 5:** Remove the cam chain tensioner using a M6 Allen. Check gasket for any tears.

**Step 6:** Remove the (2) retaining bolts holding the top guide in place, using a 8mm socket.



Figure 33

**Step 7:** Clean the cam sprockets and chain. With a sharpie make (2) marks on each gear and chain for installation purposes.



Figure 34



**Step 8:** Place a 22mm wrench on the intake cam, spin the clutch to release pressure off the valves while loosening the intake cam sprocket. Remove the sprocket once hardware is removed.



Figure 35

**Step 9:** Loosen both camshaft carriers using a 8mm socket. Remove carriers and cam shafts from the engine. Zip tie the cam chain up to the bed mount so the chain doesn't come off the crank.

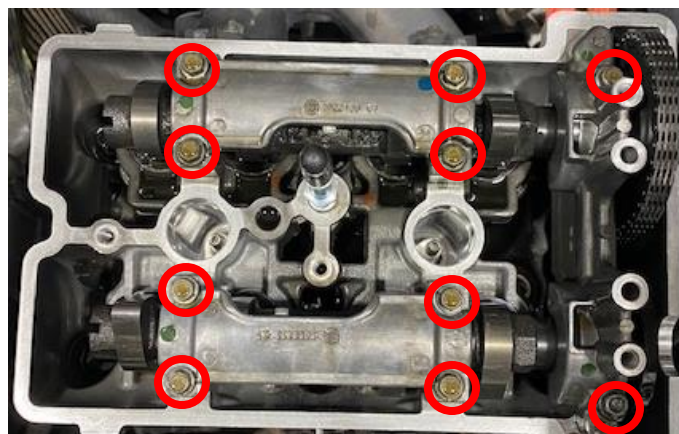

Figure 36



Figure 37

**Step 10:** Remove one head bolt and replace it with a stud at a time so the cylinder head never has more than one bolt/stud loose at a time. Lather both ends of the stud with supplied ARP assembly lube. Hand tighten the stud until it bottoms out. Place assembly lube on both sides of the washer, place the washer on the stud. Finger tighten the nut onto the stud and torque to 50 ft/lbs. See torque sequence and specifications below.

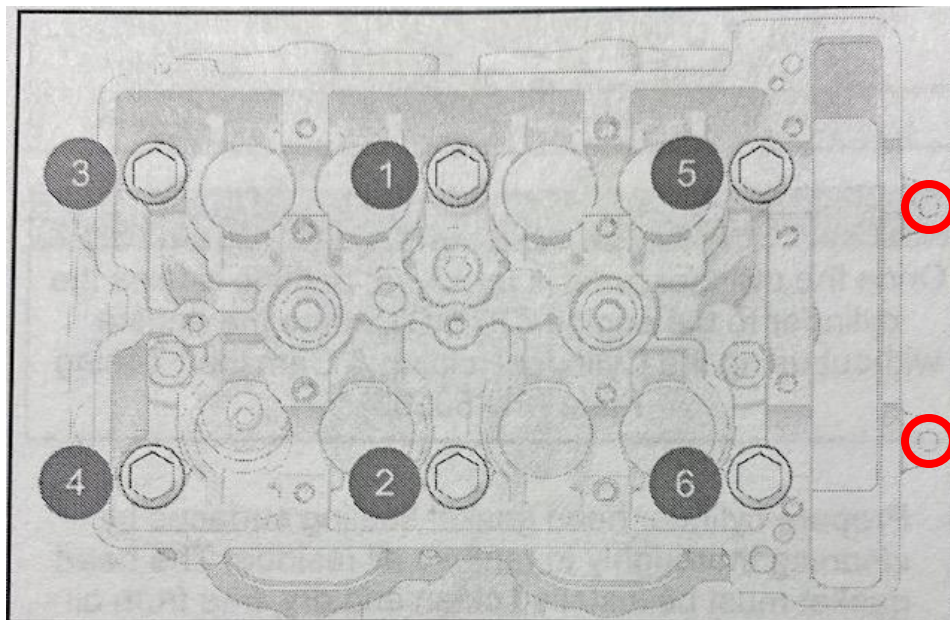

Figure 38

| Torque Specification: Head Stud | 11mm ARP 2000 | 11mm ARP 625 |
|---------------------------------|---------------|--------------|
| Step 1                          | 50 ft/lb      | 50 ft/lb     |
| Step 2                          | 68 ft/lb      | 72 ft/lb     |
| Step 3                          | 85 ft/lb      | 95 ft/lb     |

| Torque Specification: M6 Outer Bolts | 11mm ARP 2000 | 11mm ARP 625 |
|--------------------------------------|---------------|--------------|
| Step 1                               | 10 ft/lb      | 10 ft/lb     |

**NOTE:** On final torque go over the pattern a total of (3) times.

**Step 11:** Reinstall the camshafts and camshaft carriers. Snug up the camshaft carriers. Install cam shaft timing plate back into the camshafts. Verify TDC mark on the flywheel making sure the engine is still timed. Install the intake sprocket back onto the intake camshaft. Make sure your sharpie marks align properly. Apply red Loctite to the sprocket hardware and torque camshaft sprocket to 14 ft/lb. Reinstall the outer camshaft carrier and chain guide. Torque all camshaft carrier bolts to 7 ft/lb.

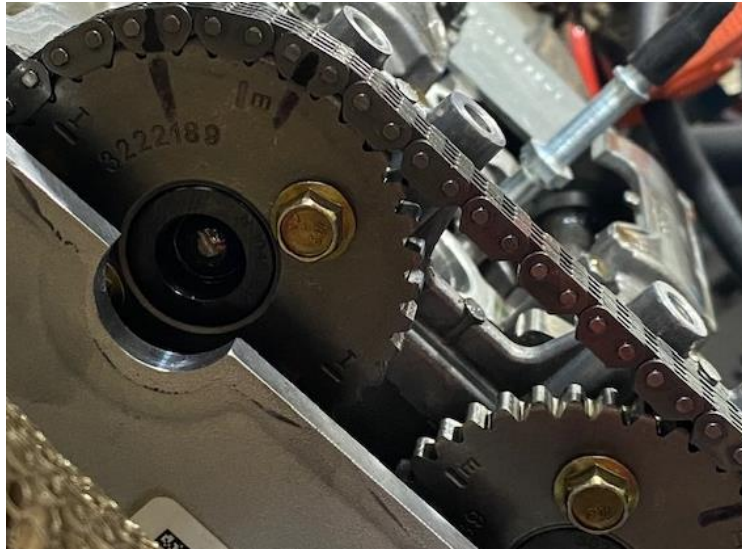

Figure 39

**Step 12:** Remove the spring retainer bolt out of the spring tensioner and push the adjuster all the way in. Install the cam chain tensioner into the block and torque the mounting bolts to 7 ft/lb. Install the tensioner spring, washer and retainer bolt. Torque spring tensioner bolt to 12 ft/lb.

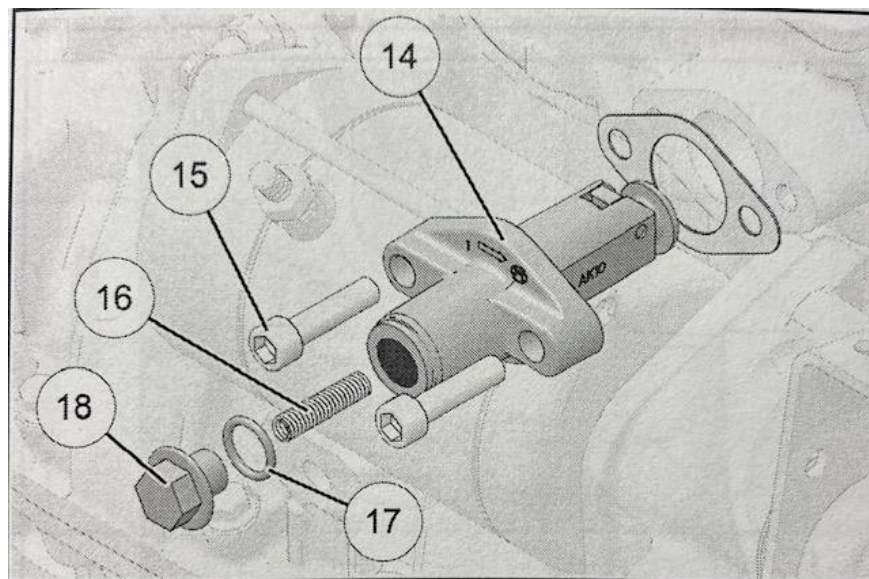

Figure 40

**Step 13:** Rotate the crankshaft two full revolutions to verify camshaft timing.

**Step 14:** Reinstall the valve cover gasket, place a silicone based liquid gasket around the two lobes before installing. Place the valve cover over the camshafts and torque (4) valve cover screws to 7 ft/lb.

**Step 15:** Remove the spark plugs and install supplied EVP spark plugs. EVP gapped plugs are .016-.018". Torque plugs to 9 ft/lb.

### **Map Sensor Installation**

**Step 1:** Remove the OEM MAP sensor from the plenum. Disconnect from the wiring harness. Install the supplied 4 bar MAP sensor into the plenum. If it doesn't align properly to the threads, remove the insert from the sensor. Apply dielectric grease to the MAP sensor O-ring. **NOTE:** we have seen misalignment with threads. Install the new MAP sensor and supplied wiring harness. Connect wiring harness back into the OEM plug.



Figure 41



Figure 42

Insert removed from MAP sensor



Figure 43

## Charge Tube & V-Flow Installation

**Step 1:** Install the supplied 4 bar MAP sensor into the charge tube. Apply dielectric grease to the O-ring for installation. Use supplied M5 screw to fasten down MAP sensor. Install the charge tube onto the turbocharger and throttle body. Reuse OEM hardware, use an 11mm deep well socket. Install EVP blow off valve or boost recirculation valve. Run supplied vacuum hose back to the plenum barb and "T" into the OEM hose.

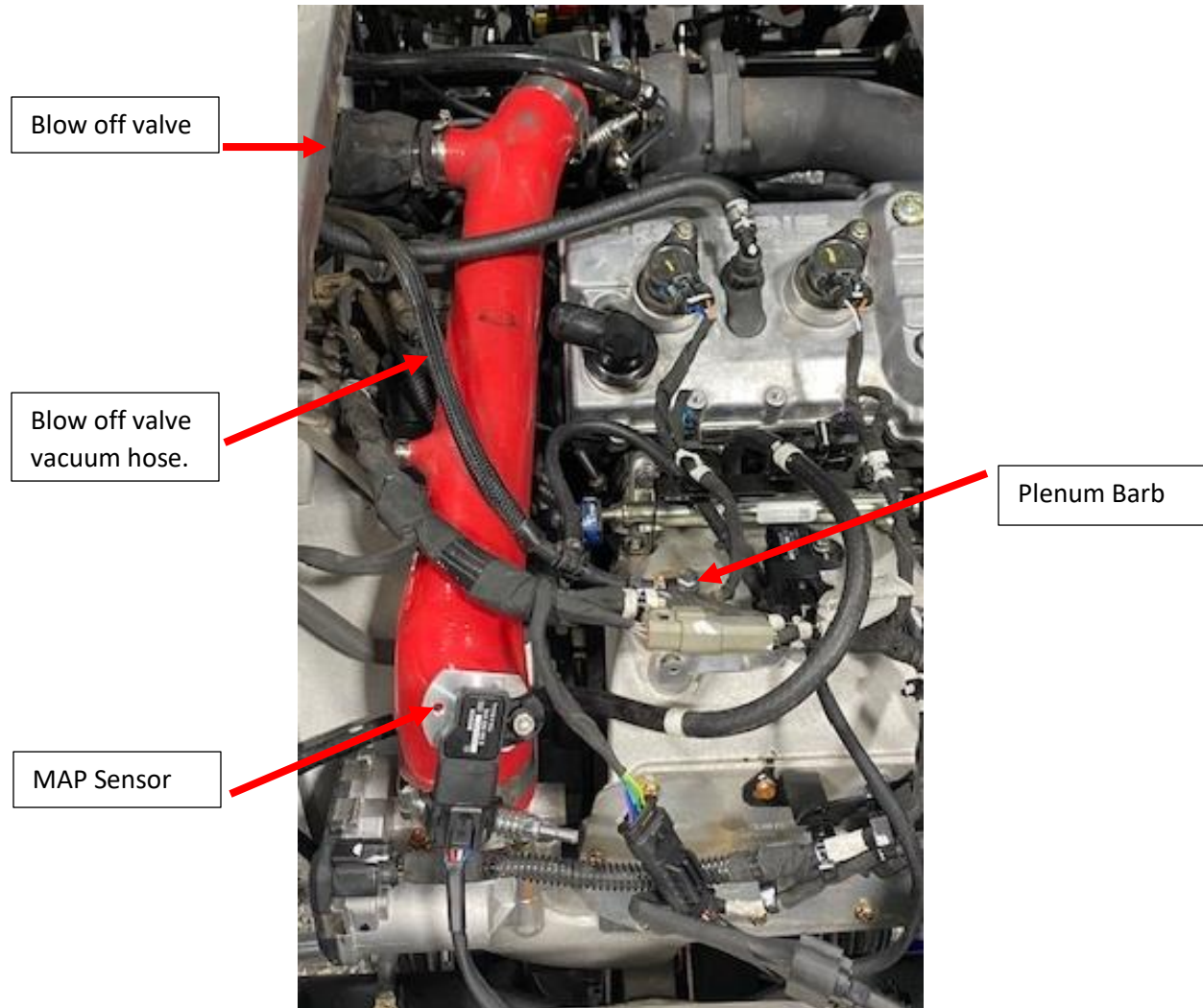

Figure 44

**Step 2:** Before installing the EVP V-Flow its easier to block off the crankcase vent and boost recirculating valve ports before installation. If you aren't running a catch can or blow off valve you can keep the ports open. Install the V-Flow onto the turbocharger and air box. Tighten down with a 11mm socket. Reinstall the OEM MAF sensor in the stock location.

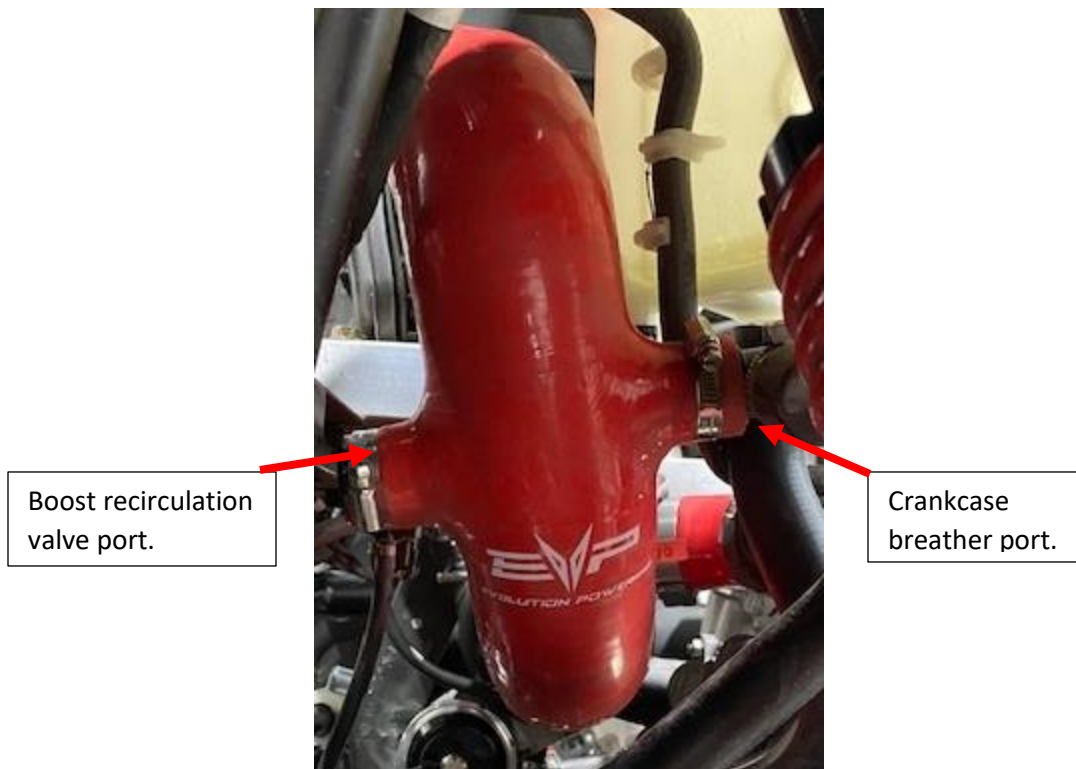

Figure 45

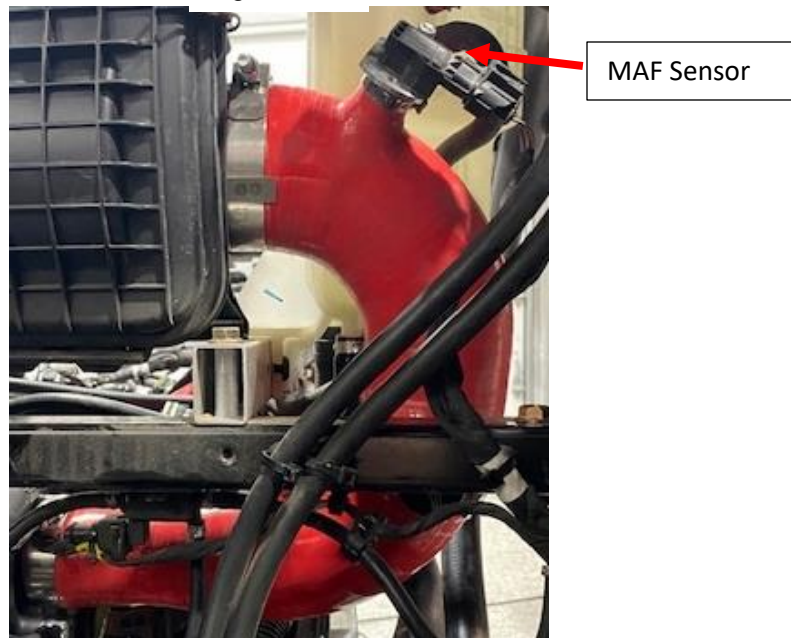
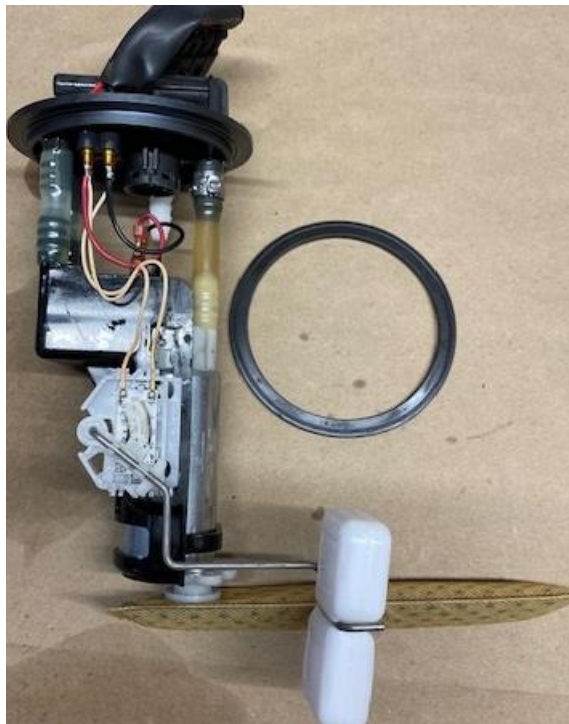

Figure 46

## Fuel Pump Installation

**Step 1:** Remove the OEM fuel pump assembly out of your vehicle. It will be located underneath the passenger seat (back passenger seat if 4-seater). **DO NOT** break the green/blue safety clips holding the fuel lines on. It is easiest to remove the fuel pump assembly nut with EVP tool (953RU0305).



XP Turbo/S OEM Assy



Pro XP/Turbo R OEM Assy

**Step 2:** Remove the float sending unit from the OEM fuel pump. On the XP Turbo/S assembly use a small screwdriver to push the black clip inward, push the sending unit upward. On a Pro XP/Turbo R use a small screwdriver and push the sending unit downward. Remove.

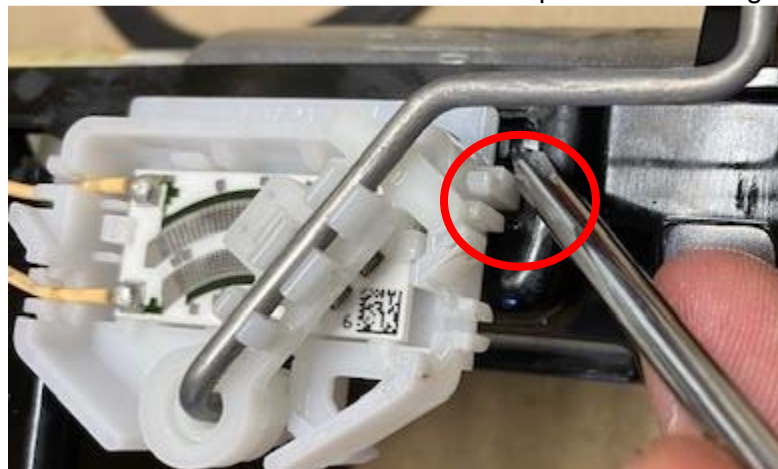

**Step 3:** Cut (3) hoses attached to the fuel hat. (2) white hoses are supports and (1) hose is for the fuel pump. If there is a pitch clamp, remove that as well. On the Pro XP/Turbo R assembly you will **NOT** reuse the spring.

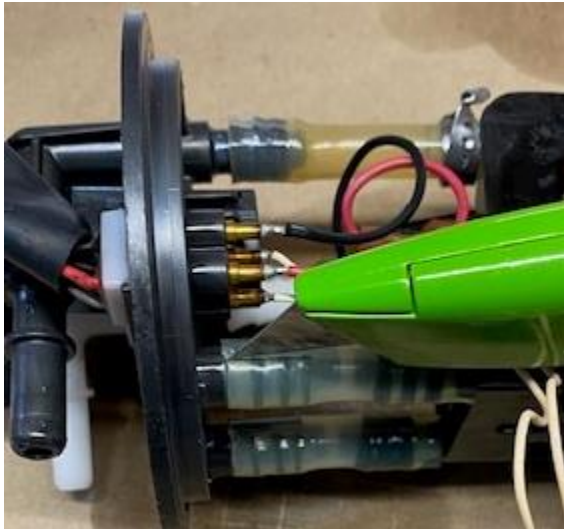

**Step 4:** Remove the positive and ground wire from the pump. You can now remove the OEM fuel hat assembly from the fuel pump.

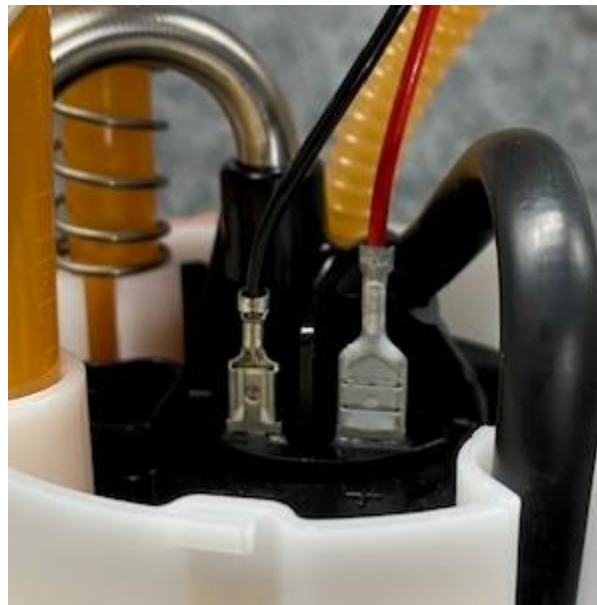



**Step 5:** Cut the OEM power and ground terminals off from the fuel hat. Measure how much wire you will need to cut off the supplied pig tail connector.



**Step 6:** Cut the supplied heat shrink in half, you should only need 1" per wire. Slide heat shrink onto each wire. Solder black to black and red to red.



**Step 7:** Connect the solder connector to the pump. It will click once installed all the way. Install the supplied 13.3mm pinch clamp onto the fuel pump hose. If XP Turbo/S assembly, you will need to heat up all (3) hoses equally until they look shiny (**DO NOT OVER HEAT**). (If Pro XP/Turbo R assembly, you can install the black corrugated fuel hose first with a 13.3mm pinch clamp and install the supports together.) Once all (3) hoses are heated install the fuel hat barbs onto the white hoses. Make sure the float wires are in between both support hoses, they will lay in the half moon on the surge tank. **MAKE SURE** all (3) hoses are pressed on all the way!

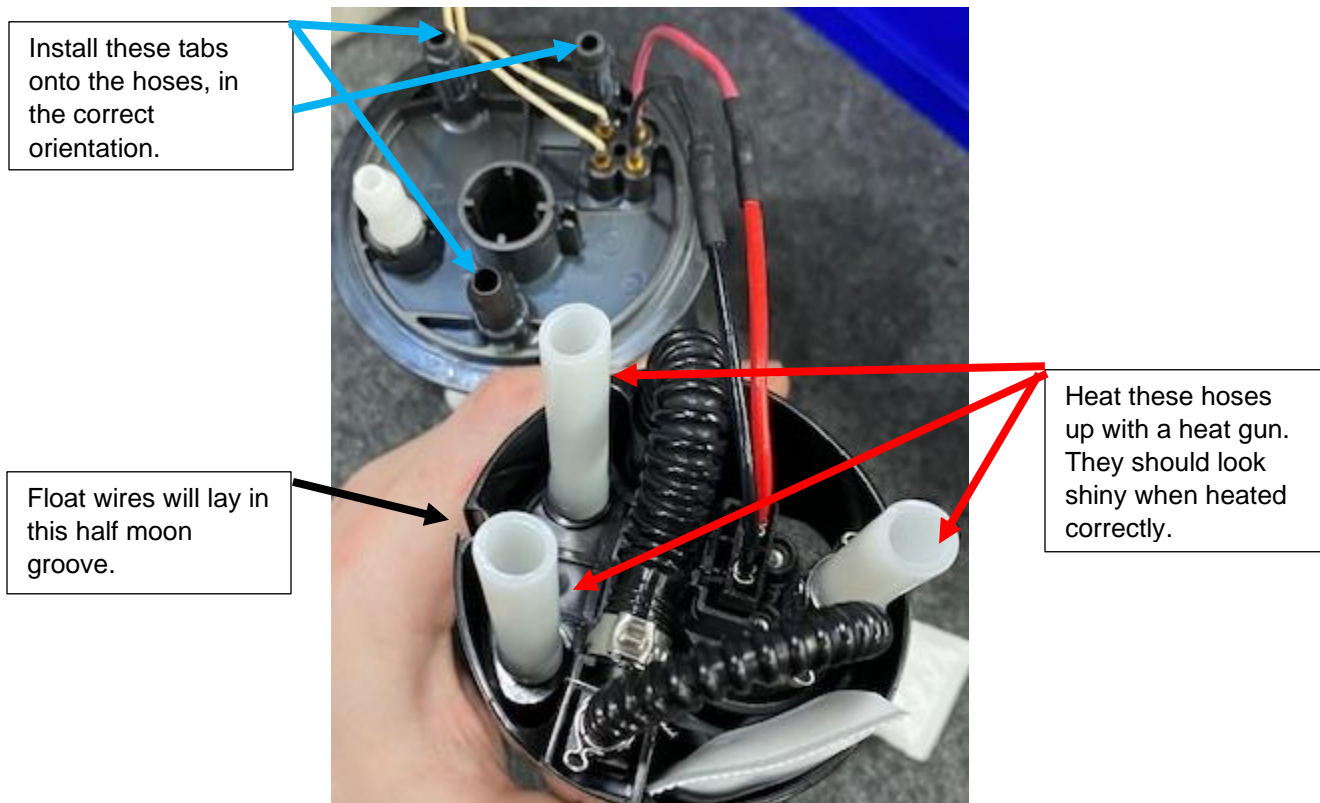



XP Turbo/S Assembly



Pro XP/Turbo R Assembly

## Installing the EVP Surge Tank Assembly

**Step 1:** Double check all hoses, clamps, float, and wiring harness before installing. Make sure to reuse the OEM circle gasket between the fuel hat and fuel tank.

**Step 2:** Always install the fuel float first and fuel sock second. You can also remove the float arm from the assembly and install into the tank. Install the surge tank into the fuel tank about 2.0". Then reinstall the float arm to the float assembly. See below.



**Step 3:** Install the O-ring gasket between the fuel tank and fuel hat. Install the fuel pump nut and keep the same orientation if it is a XP Turbo/S model. If a Pro XP/Turbo R you will flip the fuel hat orientation 180-degrees. This will allow your float to read properly. You may need to clock your fuel line in the OEM holder.



Pro XP/Turbo R Assembly Orientation

**Step 4:** Locate your fuse box (underneath steering wheel). Remove the fuel pump fuse and install supplied 20amp fuse.

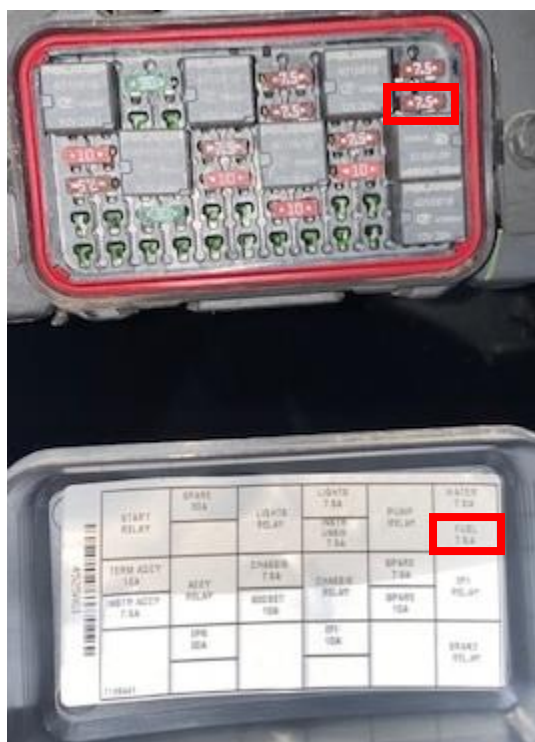



**Step 5:** Test the fuel pump by turning on the key and listen for the pump to activate. Do this several times to prime the fuel system. Check for leaks. If there are no leaks, re-install the access cover and passenger seat.

### **Clutching P43 280 Kits**

- Clutching for 280 kits must be adjusted for an **8600-8800 RPM** shift out.
- Running a 91-octane tune clutching must be adjusted for **8500 RPM** shift out.

### **MaptunerX / CodeShooter**

Now that your Paragon turbocharger kit is install, you need to flash your ECU before starting the vehicle. Make sure the proper fuel is in your vehicle before starting it. If you have already contacted your sales representative and have a big turbo file, please follow the step-by-step **MaptunerX or CodeShooter** instructions found on our website. If you have NOT contacted your sales representative, please call 715-247-3862 or email: [sales@evopowersports.com](mailto:sales@evopowersports.com)

### **Launch Control (optional)**

If Launch Control has been purchased as part of this kit, your clutching engagement RPMs **MUST** be raised to at least your chosen engagement. This kit has launch files for 2400, 2600, 2800, 3000, and 3200 RPMs. If you have any questions about clutching please contact our Tech Department [tech@evopowersports.com](mailto:tech@evopowersports.com)

**NOTE: Before initial startup, unplug the injector connectors and remove the oil drain tube from the turbocharger. Turn the car over 10seconds until you see oil coming from the drainpipe on the turbocharger. This will ensure the turbocharger is oiled before start up. All EVP turbochargers come pre-oiled this is another precaution step.**

*Thank you for choosing Evolution Powersports products. If you require further assistance, please call our Tech Support @ (715) 247-3862*

***Note:** This product is exempt from the emission standards and related requirements of 40 C.F.R. § 1051 as provided by 40 C.F.R. § 1051.620, and California law [e.g., vehicle code §§ 27156 and 38391]. This product is sold only for use in connection with EPA certified, purpose-built, nonroad vehicles used solely for closed course, nonroad competition/racing and not used for any recreational purpose or on public highways or right of ways maintained by and open to the public. This product is sold only in connection with machines that do not fall under state and/or federal noise or emission standards/regulations. Purchasers who/that purchase this product represent and warrant that the product is purchased only in connection with EPA -certified, emission-regulations-exempt and noise-regulations-exempt competition/racing vehicles as interpreted under applicable state and/or federal law. Questions: Call Evolution Powersports at (715) 247-3862.*