



2017-2021 X3/Turbo R & 2020 Turbo RR Desert-Storm 280 & 320 Turbo Kit

SKU(s): 2017-2020 X3 280 (601FC0014), 320 (601FC0015), 2020 Turbo R/RR 280 (601FC0018) 320 (601FC0019)

By purchasing this kit, you understand and agree to the following:

NOTE: Expect 24–48-hour delay from the time you request a tune to when the file is enabled. Please create your Maptuner account before starting the project. Email us at maptunerx@evopowersports.com

This is a high-performance upgrade!!!! Although we have gone through great lengths to build safety into the upgrade turbo system, the fact is installing any upgrade / turbo system requires care in both operation and installation. Poor fuel, improper setup or any number of things that are done incorrectly can damage your engine!

- You have likely voided the sound and exhaust emission standards of your country if applicable
- This upgrade is intended for OFFROAD and RACING use only
- This is a performance upgrade which may shorten the life of your engine, especially if installed incorrectly or operated without regard to your instruments
- The fuel requirements must be adhered to!!!! Poor fuel can destroy an engine in seconds!!!
- Evolution Powersports bears no responsibility for damage caused to your vehicle by the installation of EVP products. The warranty on big turbo kits is 30 days from the date of purchase. Evolution Powersports, at its discretion will determine whether a part meets the warranty requirements. In no case is there any warranty from EVP for your vehicle or vehicles drivetrain. Although we have been careful to supply you with the highest quality parts possible, we assume no liability for damage to the vehicle or personal injury from installing or using any of our products.
- The installation of this kit is technical and mechanical in nature with many opportunities to make mistakes – mistakes that can be very costly! If you are not qualified to install this kit, don't do it!! Bring it to one of our qualified installation centers to do the installation.
- This kit will make your vehicle faster, climb higher and accelerate more quickly and take a longer distance to brake than a stock tuned vehicle. If you are not capable of controlling the vehicle with the added performance, do not install the kit.
- High boost is hard on spark plugs – they must be changed frequently. If you experience misfire issues – Gap and replace the spark plugs!
- A full exhaust and clutching are required for this kit and can be purchased separately
- Do not ever allow a child or an unqualified driver to operate this vehicle!!!!!!!!!!!!!!!



Level	Tunes	Max Boost (psi)	Spark Plug Gap	Waste Gate (psi)	Engine HP
DS-280	91, 100	24	.016 - .018	6.5 (Green Spring)	280 (100)
DS-320	91, 100, 110, E85	29	.016 - .018	6.5 (Green Spring)	320 (E85 or 110)

<p>Parts included with Desert Storm 280 Kit:</p> <ul style="list-style-type: none"> EVP Desert Storm Billet Ball Bearing Turbo Upgrade Desert Storm DS 280 & 320 Install Kit Maverick X3 Silicone Charge Tubes with BOV Port Maverick X3 Blow Off Valve Kit Can Am X3 Injectors – Set of 3 Maverick X3 Big Intake Outlet with New Silicone Boot Maptuner X for BRP Vehicles (Includes Maptuner X and BRP Cable) 	<p>Required Tools:</p> <ul style="list-style-type: none"> Sockets (7mm, 8mm, 10mm, 11mm deep, and 13mm deep) T40 Torx Side cutter / wire cutter 4mm Allen 10mm wrench Die grinder
<p>Parts included with Desert Storm 320 Kit:</p> <ul style="list-style-type: none"> Desert Storm 280 Kit Ultra-High Efficiency Intercooler – with Race Core Can Am Maverick X3 Head Stud Kit – Set of 8 X3 HD Intake Plenum – Raw Aluminum 	<p>Recommend Accessories:</p> <ul style="list-style-type: none"> Boost gauge AFR gauge <p>Required Accessories:</p> <ul style="list-style-type: none"> EVP or other Full Exhaust

Parts list for DS-280 and DS-320 Install Kit:

1	Turbo Oil Feed Line	2	Bosch 4 BAR MAP Sensor
1	Fire sleeve for Oil Hose	1	MAP Sensor Adaptor Harness
1	Oil Drain Gasket	1	Fuel Pump
1	Oil Drainpipe	2	18mm Pinch Clamp – Water Hose
1	27mm Pinch Clamp – Oil Drain Hose	1	Fuel Pump Adaptor Harness with Relay
1	20A Fuse		

TURBO REMOVAL

- Step 1:** Remove panel between the seats that allows access to the turbocharger.
- Step 2:** Remove and label pressure lines from the boost control solenoid going to the wastegate actuator, intake, and air box.
- Step 3:** Remove the worm drive clamp holding the intake tube onto the turbo.
- Step 4:** Remove the worm drive clamp on the top of the air box.
- Step 5:** Using a 13mm socket remove the 2 bolts behind the driver seat holding the air box to the firewall.
- Step 6:** Remove the worm drive clamps or t-bolt clamps holding the charge tubes to the intercooler.
- Step 7:** Using a 10mm socket, remove the fasteners (4) holding the intercooler in place. Be sure to unplug the intercooler fan. Remove intercooler assembly from vehicle.
- Step 8:** Remove the nut on the V-band clamp holding the exhaust onto the turbo.
- Step 9:** Remove the worm drive clamps holding the heat shielding on to the mid-pipe. Remove heat shields from mid-pipe.
- Step 10:** Remove oil drain line from turbocharger by cutting the OEM clamp.
- Step 11:** Remove the charge tube from the turbo outlet.
- Step 12:** Remove oil supply line from top of the turbocharger.
- Step 13:** Remove the nut securing the water line to the bottom of the exhaust manifold.
- Step 14:** Using soft grip vise grips or hose clamps pinch off the soft coolant lines that supply and return water to the turbo.
- Step 15:** Remove the OEM clamps holding the soft coolant line to the hard line on top and bottom. Using a side cutter, cut clamps securing soft water lines to the hard lines.
- Step 16:** Remove socket head cap screw securing hard water lines to turbocharger and remove the hard line.
- Step 17:** Remove bolts securing exhaust manifold heat shields – lower heat shield can be removed. Upper heat shield must stay on until the turbo is loose.
- Step 18:** Using a 10mm socket or T40 Torx remove the fasteners holding the exhaust manifold to the engine and remove the turbo from the vehicle.
- Step 19:** Remove oil pressure sensor and OEM oil line (be sure to save the copper washers)

EVP Turbo Installation

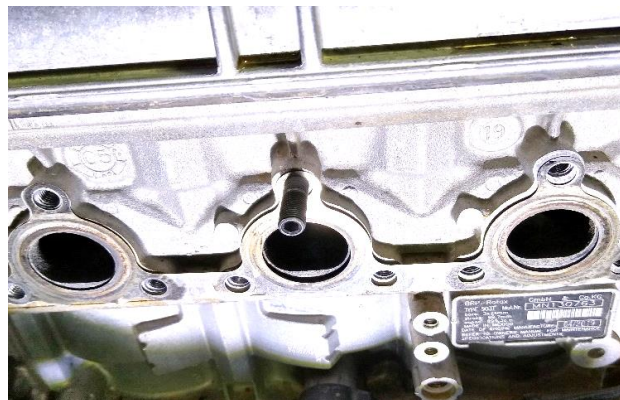

(Figure 1)

Step 1: Slide supplied fire sleeve over the supplied oil hose. Reinstall oil pressure sensor through the banjo side of the EVP oil supply hose. Re-use copper washers (install a copper washer on both sides of the banjo fitting).

Step 2: Install the provided stud into the top hole of the center exhaust port, thread stud in and back it one full turn (See Fig. 1)

TIGHTENING TORQUE		
Turbo charger retaining screws	STEP A	5 N•m ± 0.6 N•m (44 lbf•in ± 5 lbf•in)

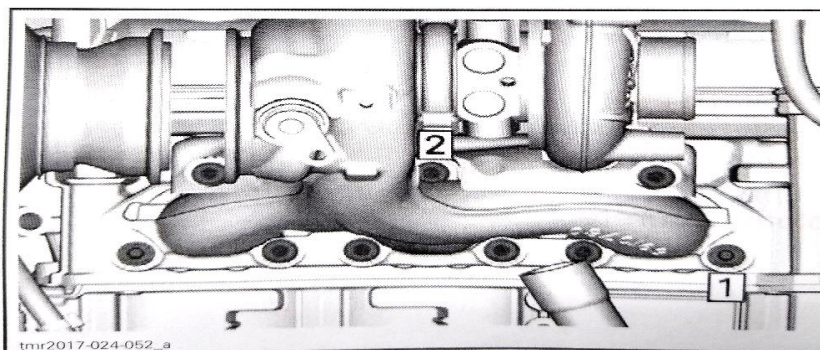

(Figure 2.)

Step 3: Reinstall the OEM exhaust gasket and install new turbo charger, reusing OEM fasteners.

Step 4: Torque (2) of the retaining screws to 44 in-lb. (about 4 ft-lb), following the order shown in Figure 2.

Step 5: Torque retaining bolts to 17 ft-lb, following the order shown in Figure 3. On the final torque sequence use a 4mm Allen wrench and hold stud while tightening copper nut with 10mm wrench to 17 ft lbs. as you can. (Make sure you have at least 2 threads protruding from nut.)

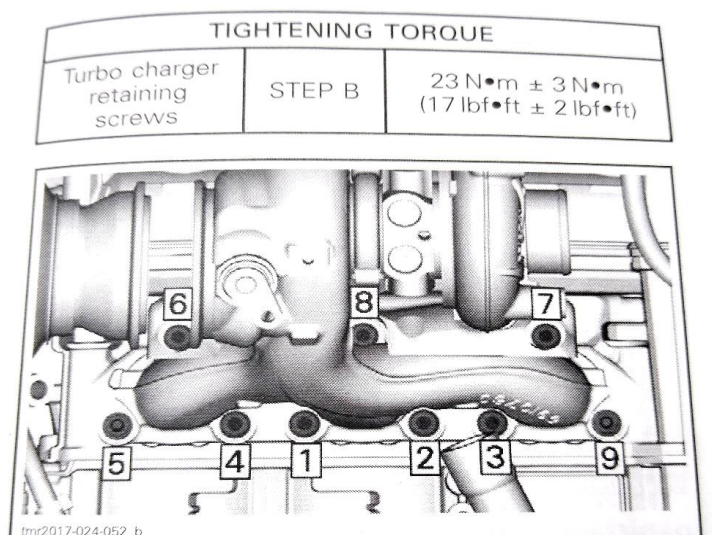

(Figure 3a)

Step 6: Connect the oil line to the fitting on the top of the turbo and tighten it.

Step 7: Reconnect the oil drain and use a 27mm pinch clamp to secure the oil line onto the turbo charger.



(Figure 3b)

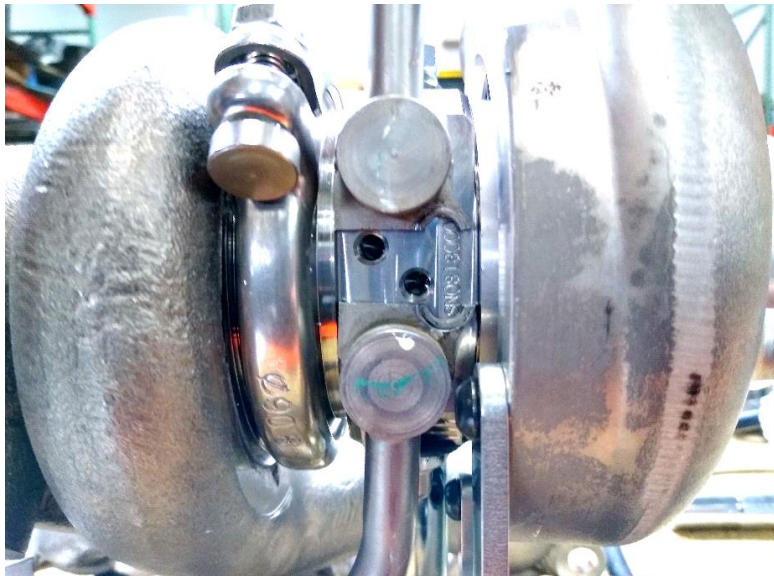

(Figure 4)

- Step 8:** The OEM hard coolant line attachment bracket needs to be cut in the center of the 2 cooling ports (See Fig. 5)
- Step 9:** Now that the line bracket is cut, be sure to put the new supplied O-rings on the coolant fittings. Use supplied retaining bracket to secure the turbo.
- Step 10:** Connect the soft coolant hoses to the hard lines installed in step 9. Secure with 18mm pinch clamps.
- Step 11:** Install the new upper charge tube onto the turbo.
- Step 12:** Install EVP intake plenum (optional).
- Step 13:** Reinstall the intercooler and connect the charge tubes and intercooler fan.
- Step 14:** Connect the new V-flow to the air box and reinstall the air box to the firewall. Tighten the clamps on the v-flow. (See V-flow instructions for further detail)
- Step 15:** Connect the 3 lines from the boost control solenoid to their corresponding locations.
- Step 16:** Reinstall exhaust - be sure to install the EVP supplied heat shield for the turbo exhaust housing. Additional heat shielding may be required. It is up to the customer and/or installer to determine what additional shielding may be required.

2018-2020 Maverick X3 AEM Fuel Pump

NOTE: Fuel Pump for (280 and 320 Kits Only – for 360 & 420 Kits proceed to the rising rate section of these instructions)

NOTE: It is best to syphon all fuel out of the tank prior to starting this job.

NOTE: The fuel pump relay harness must be installed prior to powering up the dash or starting the vehicle- failure to do so will damage your ECU.

Step 1: Remove plastics covering fuel tank. See picture below for location

Step 2: Unplug electrical connector going into the top of the pump.

Step 3: Unhook fuel hose by removing the red clip from the connection. Then push down on the fitting while pushing in on the back side of the fitting – then lift the fitting off the pump assembly.

Step 4: Rotate pump assembly cap counterclockwise and remove. Remove assembly. (see the pictures on the next few pages for clarification)

NOTE: Your fuel pump assembly **MUST** be the 172 HP Turbo R or 195 HP RR versions! If you have a 2017 X3 or a 120 Base Model that has not been updated to the Turbo R or RR pump assembly, this must be purchased separately!



(Figure 1)

Step 5: With the fuel pump on a workbench and all the fuel drained out of the pump assembly, press in on the tabs to release the housing covering the tank.

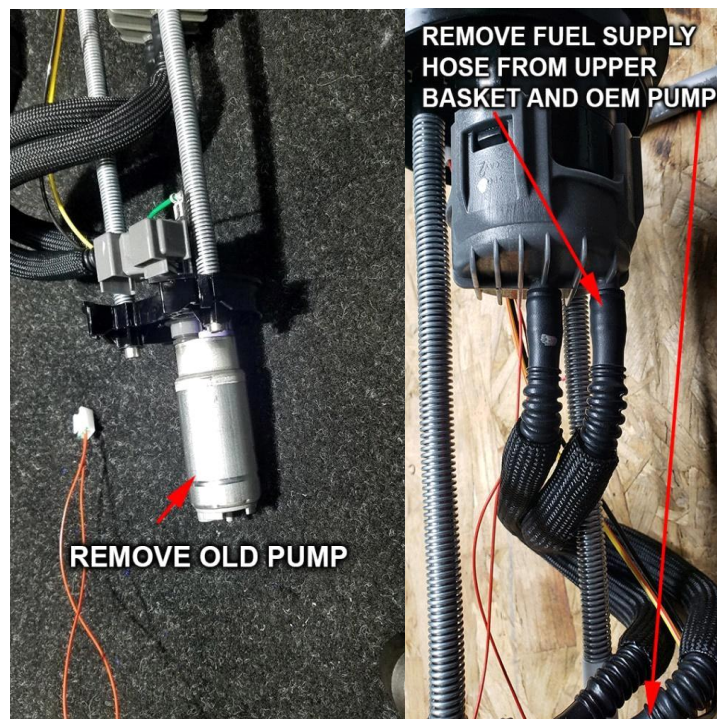
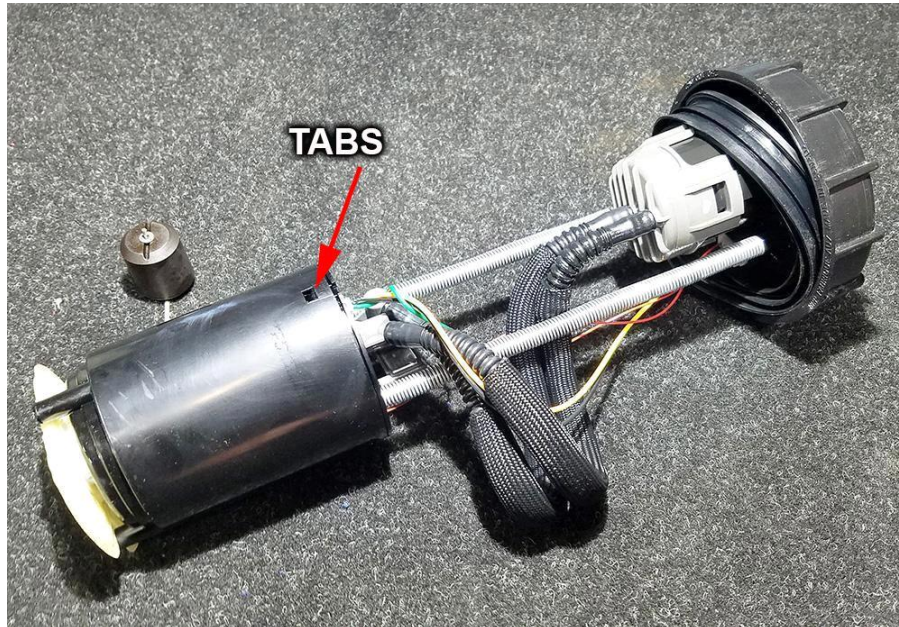

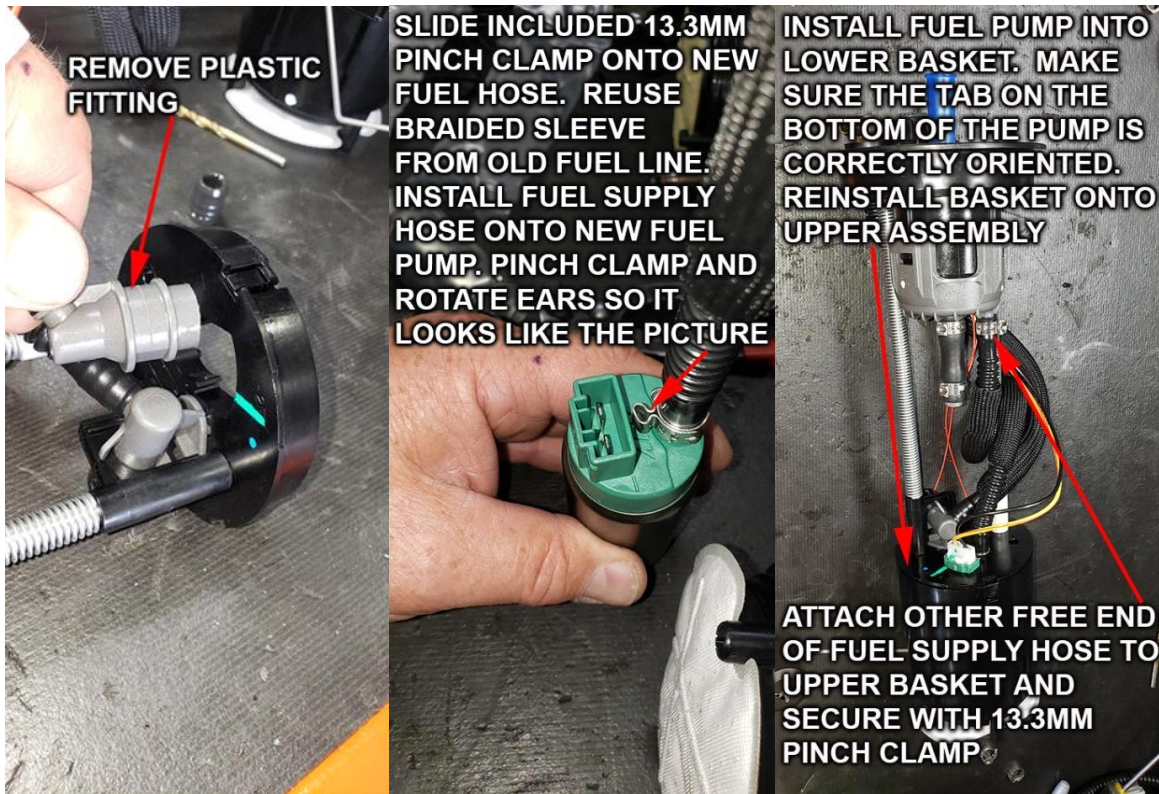

- Step 6:** Install fuel pump assembly back into tank in the reverse order from its removal.
- Step 7:** Install the EVP supplied fuel pump into the plastic housing that was removed in step 5 on the previous page. Make sure the pump is oriented and fitted correctly into the bottom of the housing - when properly oriented, the pump will drop into place and it will not rotate.
- Step 8:** Plug the electric connection into the pump.
- Step 9:** Carefully align the tabs and reinsert the cap into the housing – do not force it – if it does not fit in with moderate pressure, something is not correct – recheck. See picture below of fuel line and electrical connection.
- Step 10:** Reinstall pump assembly.
- Step 11:** Install EVP Plug-N-Play fuel pump relay harness.
- Step 12:** Connect the yellow wire with the ring terminal and the relay to one of the bolts that secure the fuel pump protector strap to the frame. Make sure the ring terminal is grounded to the frame.
- Step 13:** Replace OEM fuel pump fuse with the supplied 20 amp in location F5.



Map Sensor Replacement

- Replace the 2 OEM map sensors with the EVP supplied sensors: One sensor is located on the plastic intake manifold plenum. The second sensor is located on the throttle body.
- For the throttle body map sensor use the supplied adaptor harness to make the electrical connection.
NOTE: It is possible to install the map sensor adapter harness to the OEM plug backwards. If you are getting a MAP sensor codes, 180 the plug.
- Tighten the 2 OEM clamps that secure the throttle body – this **WILL** pop off if not tightened.

Clutching (280-320 Kits)

NOTE: Clutching for 280-320 kits must be adjusted for an **8800-9000 RPM** shift out.

NOTE: Running a 91-octane tune clutching must be adjusted for **8100 RPM** shift out.

Launch Control (optional)

NOTE: If Launch Control has been purchased as part of this kit, your engagement RPMs **MUST** be raised to at least 2600 RPMs but preferably 3000 RPMs. The reason is big turbos require more energy to spool and it takes more RPMs to generate enough heat. Although Launch Control will work at 2600 RPM, it cannot build more than a few lbs. of boost at 2600. At 3000 RPMs, 7-8 lbs. of boost at sea level and modest air temperatures is possible.

Thank you for choosing Evolution Powersports products. If you require further assistance, please call our Tech Support @ (715) 247-3862

Note: This product is exempt from the emission standards and related requirements of 40 C.F.R. § 1051 as provided by 40 C.F.R. § 1051.620, and California law [e.g., vehicle code §§ 27156 and 38391]. This product is sold only for use in connection with EPA certified, purpose-built, nonroad vehicles used solely for closed course, nonroad competition/racing and not used for any recreational purpose or on public highways or right of ways maintained by and open to the public. This product is sold only in connection with machines that do not fall under state and/or federal noise or emission standards/regulations. Purchasers who/that purchase this product represent and warrant that the product is purchased only in connection with EPA -certified, emission-regulations-exempt and noise-regulations-exempt competition/racing vehicles as interpreted under applicable state and/or federal law. Questions: Call Evolution Powersports at (715) 247-3862.