

VITRO 



AZKOYEN
GROUP

BUILDING COFFEE EXPERIENCES

COFFEE PERFECTION

Coffee is a constant in our everyday lives. Any time, any place; coffee is the catalyst that brings people together, to enjoy and to share. There are countless ways to prepare coffee and an infinite variety of coffee recipes – it's possible to say that there's a particular coffee out there for every lover of the world's favourite beverage.

Coffee drinking was first discovered by Ethiopian monks hundreds of years ago, but it's never been more popular: coffee brewing and preparation methods have evolved constantly to meet changing consumer tastes.

That's why every Vitro development is focussed on extracting the best possible coffee according to contemporary tastes, to provide the consumer with the perfect coffee experience.



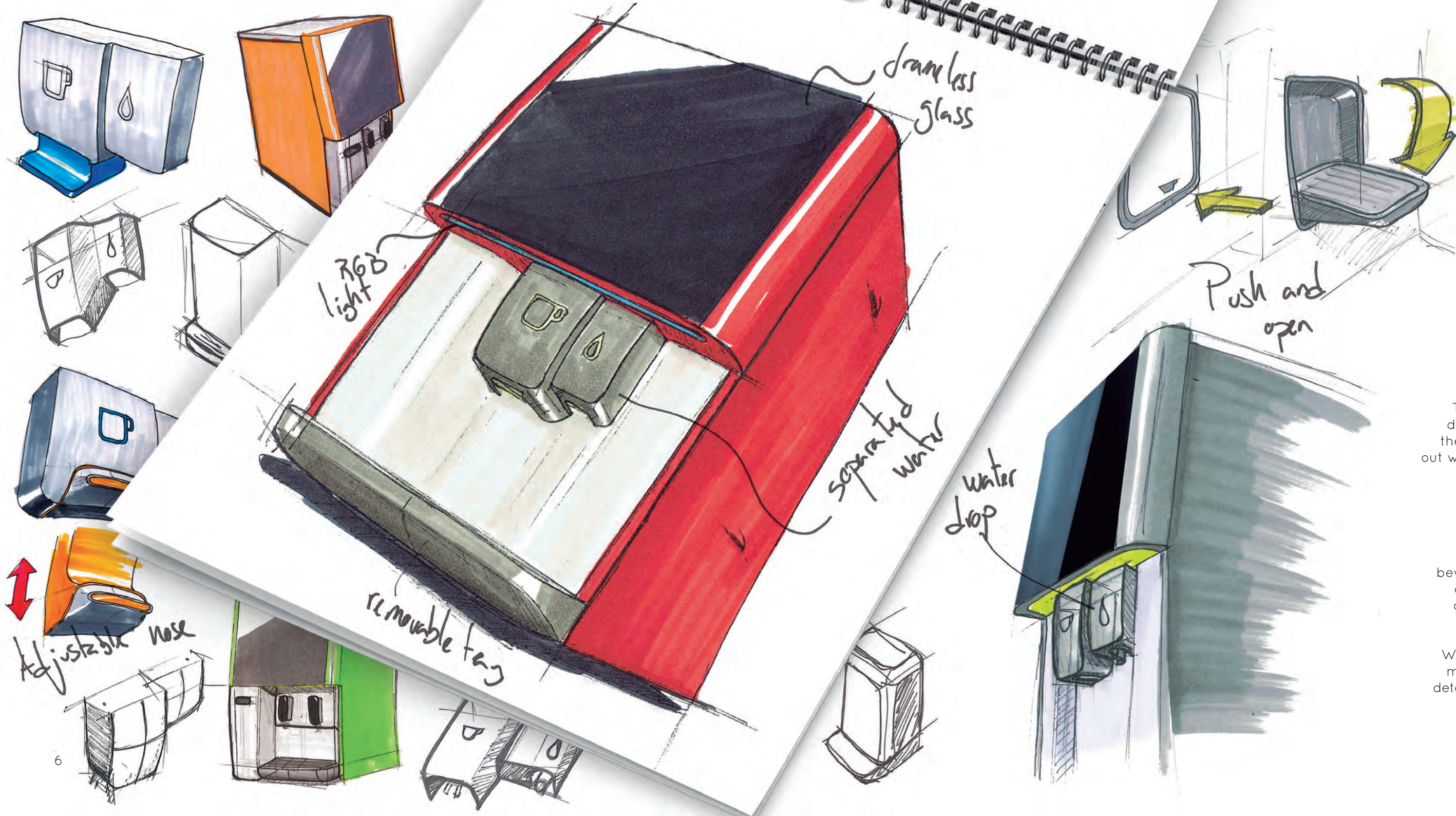

ATTENTION TO DETAIL

The Vitro range of professional hot beverage machines is designed with attention to every detail. After investigating the current design trends in the coffee industry and finding out what consumers and operators expect from an automatic coffee machine, we believe we've created a machine that combines our experience as manufacturers with a contemporary, aesthetic and timeless design.

Every aspect of Vitro enhances the user experience, the culmination of which sets the range apart from other beverage systems. Thanks to our uncompromising focus on continuous development and innovation, we've fused our growing knowledge with the demands of a fast-changing world.

We've focused on what's most important: offering the best machine and the best product; taking care of the smallest details and giving unmistakable personality and identity to the whole Vitro range.



THE ULTIMATE EXPERIENCE

Vitro's smoked glass door and touch screen user interface elegantly displays a comprehensive menu. It's a state of the art combination that will complement any location.

The user display, together with the cup positioning lighting system and intuitive tray position, guides the user through a simple and pleasing experience, every time they order a drink.

The customisable mood lighting installed along the door can easily be changed to match any colour scheme. The intelligent lighting system for the dispensing area and the beverage locator can also be changed to suit its environment.



DRINK TECHNOLOGIES



ESPRESSO

The Vitro Espresso system tamps and brews freshly ground coffee with 9 bar pressure. This is the accepted pressure to achieve the best results, delivering the ideal crema and body.



FRESH BREW TEA

The Vitro Fresh Leaf tea paperless brewing system infuses the tea by filtering hot water through the leaf tea.



INSTANT

The Vitro optimised soluble technology ensures that every soluble product is mixed at the ideal speed. The Vitro mixing bowl is developed to obtain a crema from soluble coffee, whereas the soluble milk system assures that milk is served with the desired consistency for every recipe.



DUAL BOILER SYSTEM

The dual boiler system provides the machine with an incredible capacity to serve your customers freshly ground and brewed espresso coffees time after time. You have peace of mind, knowing that all espresso coffees, soluble drinks and freshly brewed teas will be served at the optimum temperature and at the quality you demand.

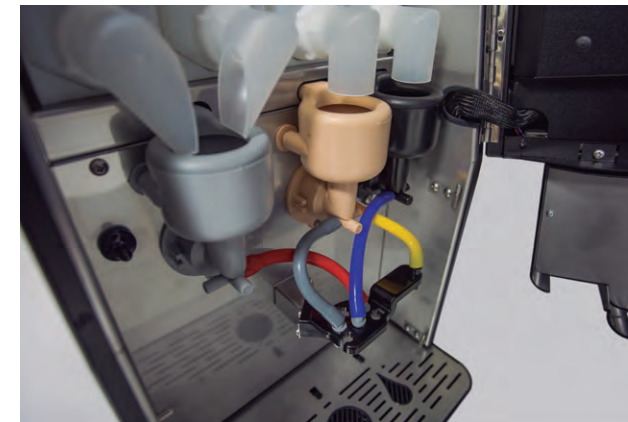
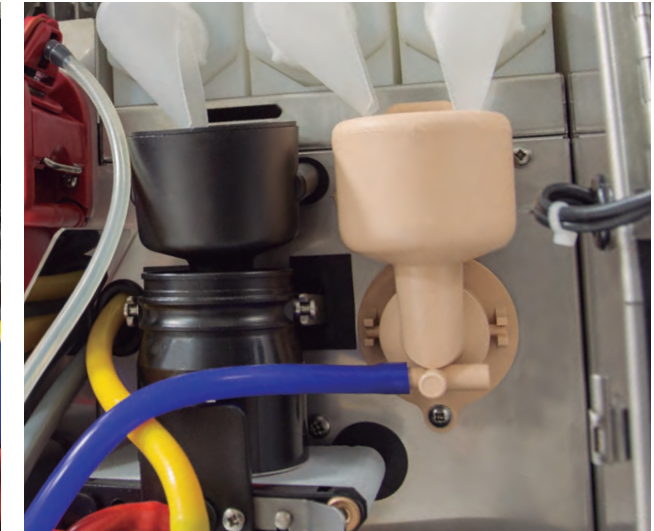

FEATURES



TOUCH SELECTION

Selections on Vitro machines are made by a simple touch, thanks to the integrated capacitive selection panel situated behind the machine's smoked glass.



LED

LED lighting provides a stylish look to the machines whilst illuminating the dispensing area.



HOT WATER SPOUT

The separate hot water spout avoids cross contamination between coffee and other soluble products.



REMOVABLE TRAY

Enables liquid waste removal without opening the machine door, for increased efficiency.



USB CONNECTION

Machine program and settings can be downloaded and uploaded via a USB key (excludes Vitro S5)



MEDIA SCREEN

A 10.1 inch HD Media player for inspirational or promotional videos is included as an option. Content can be easily uploaded via USB port or HDMI feed. The screen includes a remote control for programming. An additional RSS Airgoo feed can be integrated.



VITRO X SERIES

The Vitro X range delivers not only an authentic espresso coffee, but also the possibility of improving the menu with the addition of freshly brewed leaf tea based drinks. All in all, it's a complete coffee shop menu, which is sure to enhance your customers' refreshment experience.

FRESHLY BREWED TEAS & COFFEES

The latest technology for making high-quality espresso based drinks. The high pressure brewing system and twin coffee pouring spout ensure that the highest standards are achieved in the Vitro X series. The Vitro X3 and X4 Duo machines include a leaf tea brewing system which delivers exceptional freshly brewed tea. Moreover, the Vitro range offers an individual hot water spout for tea or special infusions.

ONE TOUCH - ONE DRINK

Vitro has found the balance between time, experience and quality. Consumers can navigate through the intuitive selection menu and select the drink they want in no time at all.

The machine will serve any coffee, tea or chocolate drink from the menu in the blink of an eye. That way, a hurried break time seems to last that little bit longer...

ENGAGE WITH YOUR CUSTOMERS

Indulge your clientele with the coffee they desire 24/7. Vitro X offers a broad range of drinks to match each and every consumer need. Furthermore, the Button Barista App allows customers to interact with the machine to customise their drinks. With the Vitro X4 series, there's also the option of installing a 10.1-inch media screen to show inspirational or promotional videos.

CONSISTANT & DURABLE

The dual boiler system means the machine has an incredible capacity to serve your customers freshly ground and brewed espresso coffees time and time again - and you can rest assured that Vitro X will deliver your clients espresso coffees, soluble drinks and freshly

brewed teas at exactly the right temperature and with the quality you demand.

STYLING

The state-of-the-art look of Vitro X is adaptable to any office, catering outlet or restaurant. The overall machine has been styled to complement any environment, thanks to its smoked glass and curved edges. What's more, the machine's RGB lighting system is customisable: you can match it perfectly with its surroundings.

OPTIMISED CLEANING

The Vitro X, along with the rest of the Vitro range, is designed with operational simplicity in mind. It's easy to remove waste containers and a colour coded pipe system means that maintenance time is minimised - which allows you to get the machine back to work within a matter of minutes.











VITRO X3

VITRO X3 ESPRESSO

Incorporates high-pressure espresso technology, providing authentic Italian style beverages. The machine attracts customers' attention and enhances the user experience every time it's used.



-  Instant
-  Touch Selection
-  RGB Led
-  USB Connection
-  Removable Tray
-  Hot Water Spout
-  Dual Boiler System
-  Espresso

 45 Kg Machine

 230Vac / 12A / 2kW / 50Hz

 Eco mode





Technical features

- 0.35 litres Pressure Boiler capacity (Espresso)
- 1.4 kW Max. power Pressure Boiler
- 2.4 litres atmospheric Boiler capacity (Instant product)
- 2.85 kW Max. power atmospheric Boiler
- 0.8 Bar Min. / 10 Bar Max. Water Pressure



Machine capacity

Coffee beans	1500 g / 210 cups
Decaf Coffee	600 g / 375 cups
Powdered Milk	1200 g / 300 cups
Chocolate	1200 g / 60 cups
Grout Bin	65 cakes

Productivity per hour

- Hot water per hour 30 litres 
- Espresso 90 cups. 
- Soluble drink 240 cups. 
- Cappuccino 80 cups. 

Drink Capacity

- Espresso 210 cups. 
- Cappuccino (Powdered Milk) 210 cups. 
- Chocolate 60 cups. 

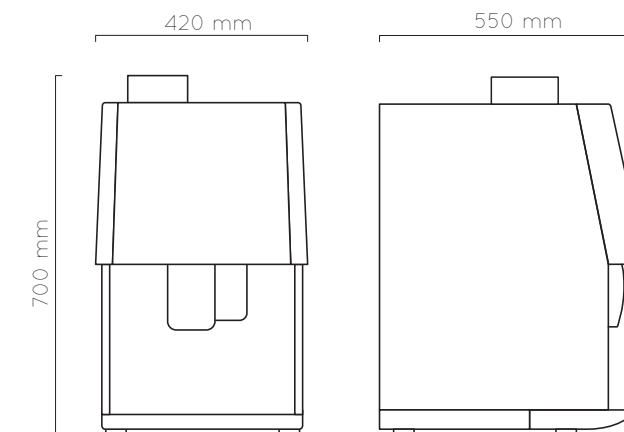











VITRO X3

VITRO X3 DUO

Features high-pressure espresso technology and a fresh-leaf tea brewing system. A complete menu of coffee shop style drinks is available including fresh-brew tea.



-  Instant
-  Touch Selection
-  RGB Led
-  USB Connection
-  Removable Tray
-  Hot Water Spout
-  Dual Boiler System
-  Espresso
-  Fresh Brew Tea

 45 Kg Machine

 230Vac / 12A / 2kW / 50Hz

 Eco mode





Technical features

- 0.35 litres Pressure Boiler capacity (Espresso)
- 1.4 kW Max. power Pressure Boiler
- 2.4 litres atmospheric Boiler capacity (Instant product)
- 2.85 kW Max. power atmospheric Boiler
- 0.8 Bar Min. / 10 Bar Max. Water Pressure



Machine capacity

Coffee beans	1500g / 210 cups
Leaf Tea	550g / 220 cups
Powdered Milk	1200g / 300 cups
Chocolate	1200g / 60 cups
Grout Bin	65 cakes

Productivity per hour

- Hot water per hour 30 litres 
- Espresso 90 cups. 
- Soluble drink 240 cups. 
- Cappuccino 80 cups. 

Drink Capacity

- Espresso 210 cups. 
- Cappuccino (Powdered Milk) 210 cups. 
- Chocolate 60 cups. 

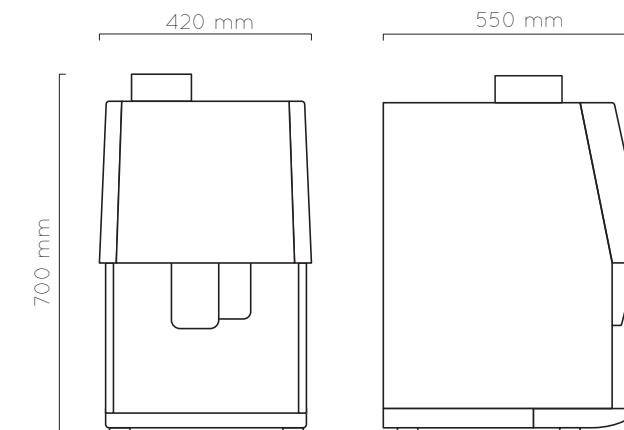





VITRO X4



VITRO X4 ESPRESSO

Combines a genuine espresso coffee based menu, with the capacity of a Free Standing machine. There's also the option of incorporating an attractive and useful Media Screen.

-  Instant
-  Touch Selection
-  RGB Led
-  USB Connection
-  Removable Tray
-  Hot Water Spout
-  Dual Boiler System
-  Espresso
-  Media Screen
-  High Capacity

 53 Kg Machine

 230Vac / 12A / 2kW / 50Hz

 Eco mode





Technical features

0.35 litres Pressure Boiler capacity (Espresso)
 1.4 kW Max. power Pressure Boiler
 2.4 litres atmospheric Boiler capacity (Instant product)
 2.85 kW Max. power atmospheric Boiler
 0.8 Bar Min. / 10 Bar Max. Water Pressure



Machine capacity

Coffee beans	3000 g / 430 cups
Decaf Coffee	1646 g / 1035 cups
Powdered Milk	2470 g / 620 cups
Chocolate	2470 g / 123 cups
Grout Bin	65 cakes

Productivity per hour

Hot water per hour 30 litres	
Espresso 90 cups.	
Soluble drink 240 cups.	
Cappuccino 80 cups.	

Drink Capacity

Espresso 430 cups.	
Cappuccino (Powdered Milk) 430 cups.	
Chocolate 123 cups.	

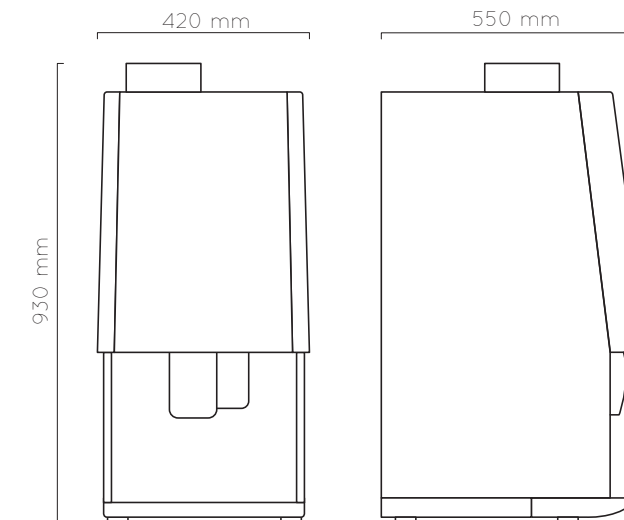











VITRO **X4**





VITRO X4 DUO

Provides genuine high pressure espresso coffee, fresh-brew tea, chocolate and milk based drinks. The machine has a large product capacity and there's an optional Media Screen.

-  Instant
-  Touch Selection
-  RGB Led
-  USB Connection
-  Removable Tray
-  Hot Water Spout
-  Dual Boiler System
-  Espresso
-  Media Screen
-  High Capacity
-  Fresh Brew Tea

 56 Kg Machine

 230Vac / 12A / 2 / 50Hz

 Eco mode





Technical features

0.35 litres Pressure Boiler capacity (Espresso)
 1.4 kW Max. power Pressure Boiler
 2.4 litres atmospheric Boiler capacity (Instant product)
 2.85 kW Max. power atmospheric Boiler
 0.8 Bar Min. / 10 Bar Max. Water Pressure



Machine capacity

Coffee beans	3000 g / 430 cups
Leaf Tea	1646 g / 660 cups
Powdered Milk	2470 g / 620 cups
Chocolate	2470 g / 123 cups
Grout Bin	65 cakes

Productivity per hour

Hot water per hour 30 litres	
Espresso 90 cups.	
Soluble drink 240 cups.	
Cappuccino 80 cups.	

Drink Capacity

Espresso 430 cups.	
Cappuccino (Powdered Milk) 430 cups.	
Chocolate 123 cups.	

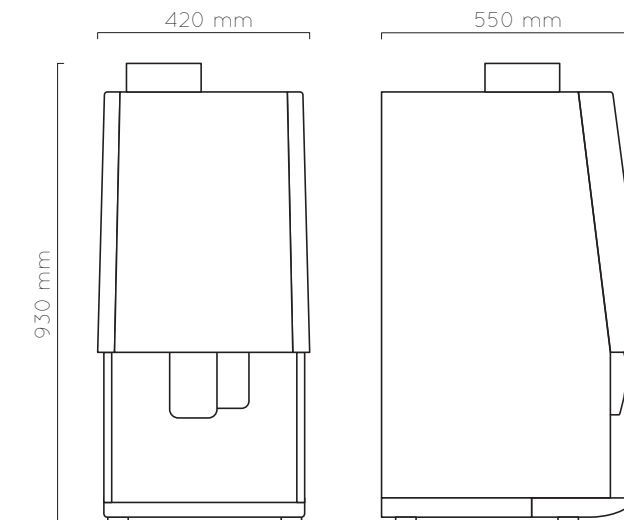

VITRO

WWW.VITROCOFFEE.COM

U.K.

Unit 1, Portishead Business Park
Old Mill Road, Portishead
Bristol, BS20 7BX
Tel.: 01275 844 471

España

Avda. San Silvestre, s/n
31350 Peralta (Navarra)
Tel.: +34 948 709 709

Deutschland

Am Turm 86
53721 Siegburg
Tel.: 02241-595 70

France

7 Allée de Londres
Le Madras Bat C2
91140 Villejust
Tel.: 01 69 75 42 10

Portugal

Bela Vista Office
Estrada de Paço
de Arcos, 66
2735-336 Cacem
Tel.: 1210 985 212

Colombia

Via la Virginia, Corregimiento
Caimalito. Bodega B-16.
Zona Franca Internacional
Pereira
Tel.: +57 6 31 105 13

United States

1100 South Tryon Street,
Suite 200
Charlotte, NC 28203
Tel.: (803) 524-1008

Vending Systems Division



84800291 - 1810

AZKOYEN

