

PARTS FOR TRIANGULAR AXLES

triangular gears, pinions, pulleys, contrate
22cp3p 21p3p 25b3p 27p3p 28P3P

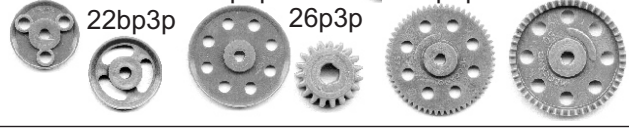

ČČ Ć	PULLEY WITHOUT BOSS 1 «" PLASTIC	GREY	M	1.09
22BP3P	PULLEY WITH HOLES 1"	GOLD	M	2.07
22CP3	PULLEY 25 MM	GOLD	M	0.85
23BP3	PULLEY 12 MM	GOLD	M	1.50
25B3P	PINION 12 TOOTH	BLACK	M	0.93
26P3P	PINION 19 TOOTH	BLACK	M	1.40
27P3P	GEAR WHEEL 57 TOOTH	GOLD	M	2.48
28P3P	CONTRATE WHEEL	BLACK	M	2.09

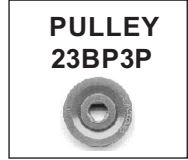

TRIANGULAR AXLE RODS

ČČĎF	AXLE ROD TRIANGULAR 1 1/4"	ZINC	M	9.14
318A	AXLE ROD TRIANGULAR 1 1/2"	ZINC	M	9.14
317	AXLE ROD TRIANGULAR 2"	ZINC	M	10.19
316A	AXLE ROD TRIANGULAR 2 1/2"	ZINC	M	11.76
316B	AXLE ROD TRIANGULAR 3"	ZINC	M	13.44
316	AXLE ROD TRIANGULAR 3 1/2"	ZINC	M	14.00
315B	AXLE ROD TRIANGULAR 4"	ZINC	M	15.86
315A	AXLE ROD TRIANGULAR 4 1/2"	ZINC	M	17.12
315	AXLE ROD TRIANGULAR 5"	ZINC	M	17.12
314	AXLE ROD TRIANGULAR 6 1/2"	ZINC	M	18.50

MECCANO Elektrikit PRICE LIST

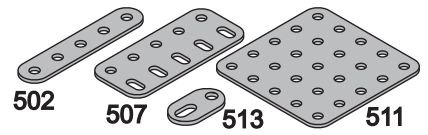

ĐČČ	INSULATING STRIP 5 1/2" (140 MM)	12.50
502	INSULATING STRIP 2 1/2" (63.5 MM)	10.00
503	INSULATING STRIP 1 1/2" (38 MM)	7.50
507	INSULATING FLAT GIRDER 2 1/2" (63.50 MM)	7.25
508	INSULATING FLAT GIRDER 1 1/2" (38 MM)	4.40
510	INSULATING PLATE 5 1/2" X 2 1/2" (139 MM)	47.50
511	INSULATING PLATE 2 1/2" X 2 1/2" (63.50 MM)	25.00
513	INSULATING FISHPLATE	5.00

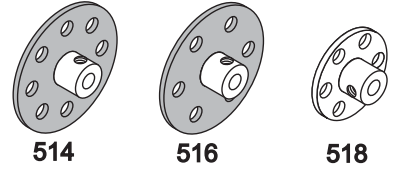

ĐČČ	INSULATING 8 HOLE BUSH WHEEL	18.45
516	INSULATING 6 HOLE BUSH WHEEL	18.45
518	BUSH WHEEL 1" (25.4 MM)	12.00



ĐČČ	RECTANGULAR COIL	60.00
522	CYLINDRICAL COIL	60.00

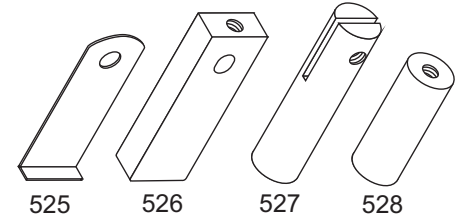

ĐČĐ	CORE HOLDE/RECTANGULAR COIL	1.00
527	CORE FOR CYLINDRICAL COIL SLOTTED	10.35
526	CORE FOR RECTANGULAR COIL THREADED 1" (25.4)	8.80
528	CORE FOR CYLINDRICAL COIL THREADED 1" (24.40)	7.80

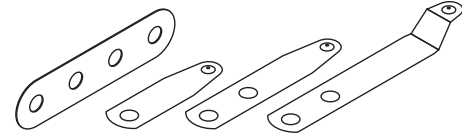

ĐČČ	FLEXIBLE STRIP 2" (5.8 MM)	3.50
531	WIPER ARM 1" (25.4 MM)	4.20
532	WIPER ARM 1 1/2" (38 MM)	2.90
533	WIPER ARM 2" BENT (50.8 MM)	14.00

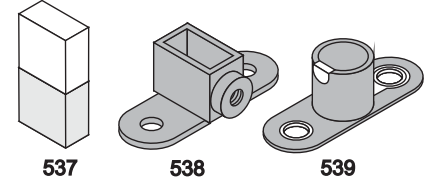

ĐČĐ	MAGNET	NO STOCK
538	MAGNET HOLDER	10.00
539	LAMP HOLDER	20.00

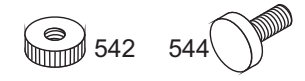

ĐČČ	TERMINAL NUT	2.00
543	CONTACT SCREW	15.00
544	CONTACT STUD	3.50

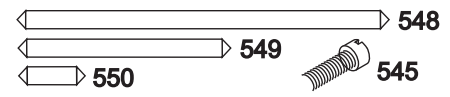

ĐČĐ	PIVOT BOLT	5.60
548	PIVOT ROD 3 1/2" (88.9 MM)	5.45
549	PIVOT ROD 2" (50.8 MM)	4.35
549A	PIVOT ROD 1" (25.4 MM)	2.80
550	PIVOT ROD 5/8" (.625 MM)	2.75

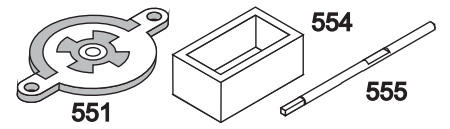

ĐČČ	FLAT COMMUTATOR	37.45
554	SHORT CIRCUIT PIECE	2.00
555	ROD WITH SQUARE END	12.60

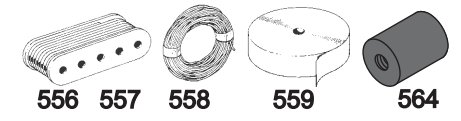

ĐČĐ	P.V.C. SLEEVING ON REEL	4.45
557	COPPER CONNECTING WIRE ON REEL	3.00
558	INSULATED CONNECTING WIRE	3.30
559	COIL OF PAPER	2.60
563	SCROD ROD (NON FERROUS)	4.20
564	INSULATING SPACER	4.50
560	DIAL CARD	20.00

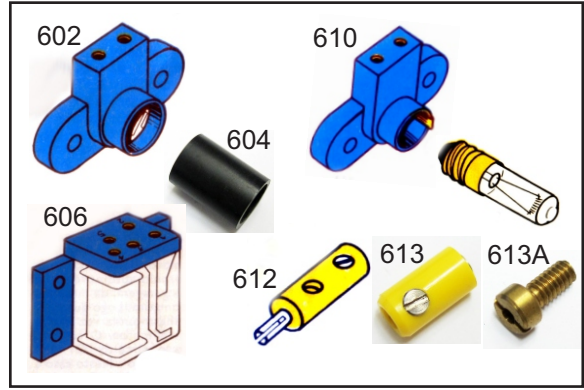

ELECTRONIC PARTS

E602	PHOTO CELL	40.00
E604	PHOTO CELL HOOD	4.00
E606	RELAY	95.00
E608	PRE FOCUS BULB (12VOLT)	12.00
E610	LAMP HOLDER	30.00
612	MINI PLUG FOR RELAYS	2.50
613	MINI PLUG SOCKET	2.50
613A	SOCKET ADAPTOR BOLT	30.00

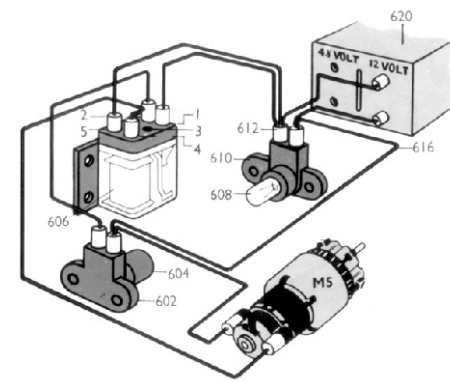

BREAKING THE LIGHT BEAM STOPS THE MOTOR.

THE ELEKTRIKIT MANUAL PHOTOCOPY (32 PAGES) IS AVAILABLE AT R39.00. INC VAT. POST EXTRA.

ELECTRONIC INSTRUCTIONS 25.00 PLUS POST.