

M036

Amsterdam Windmill Flower House



Instruction Manual

NOTICE OF ASSEMBLE

Making tips

1. LED wiring indication:
White=Positive; Grey=Negative.
2. Use a craft blade to carefully skim over the plastic to bare the copper wire.
3. For LED wiring extension, please refer to the below steps:



Twist the copper of both LED wire and extension wire together.



Do the same on the white wire.
Remarks: Tie a knot at the end of the grey wire to differentiate the polarity.

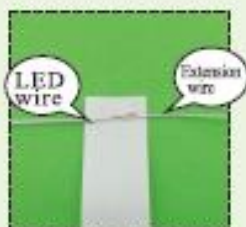

Place the duly twist wire on the tapes provided.



Roll and wrap the wire.



Place another wire next to it.
Remarks: DO NOT contact both copper wire to avoid short circuit.



Roll and wrap it together.

How to assemble the battery holder



1. Material and tools needed:
- Battery holder, LED bulb, tape.



2. Take the lid off from the battery holder.



3. Insert the battery take notes on the polarity.



4. Closed battery box.



5. Twist the wire from the battery box with the wire from LED bulb as above shown.(Notice if the bulb is bright)



6. Wrap the exposed wire with the tapes.



Connection diagram of a bulb.



Connection diagram of multiple bulbs.

Statement: the lamp wires cannot be inserted into the output socket.

Warnings

- The product is not suitable for children under 14 years old. The should be under custody of adults when playing with the product.
- There are small parts, please do not swallow them for avoiding dangerous accidents.

Tips for assembling

1. Pictures shown on the package may be slightly different from the actual product.
2. Please use the provided tracing paper for cutting purpose to achieve the best outcome.
3. Product designs and specification may be subject to change without advance notice for purpose of making improvement.
4. Testing on LED function:



DO NOT contact the LED wire end direct to the battery cell.



Use the provide battery holder.
- Make sue the correct polarity.

Product information





Storage cabinet

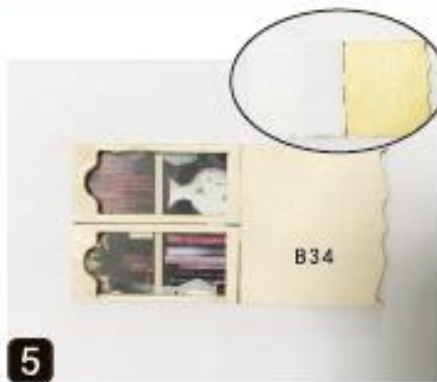

5



Cabinet

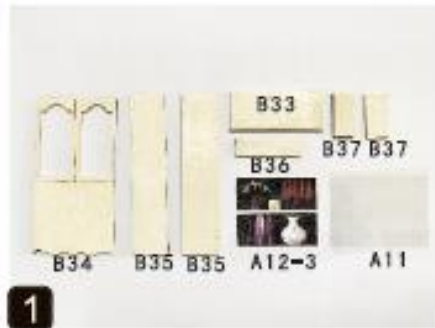

1

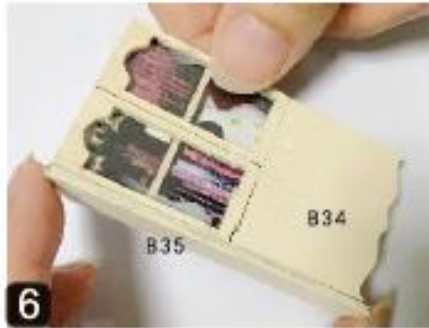

6

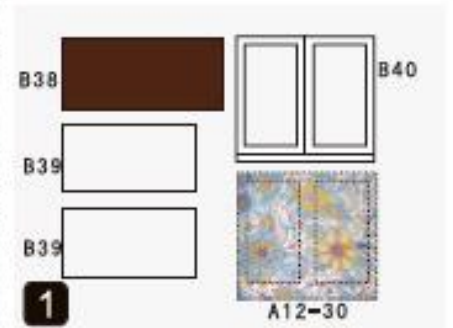

1

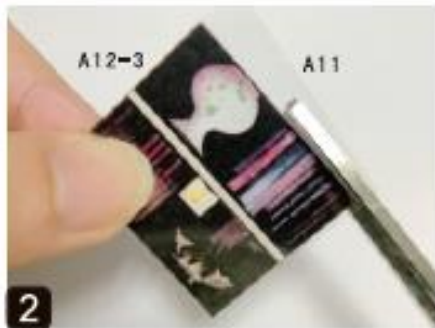

2



7



2



3



8



3



4



9



4



Storage basket



5



2

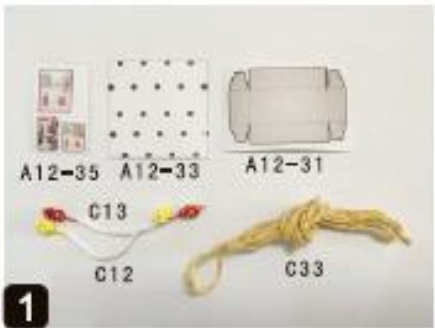

1



6



3



2



7

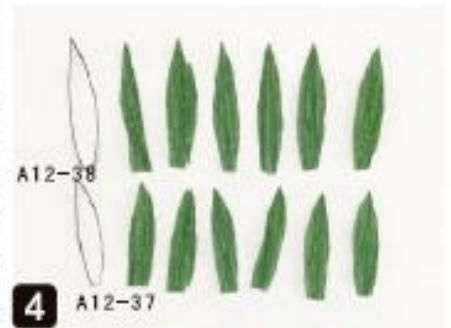

4



3



Flower

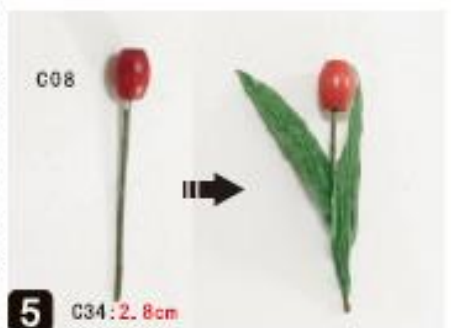

5



4

Split into two strands

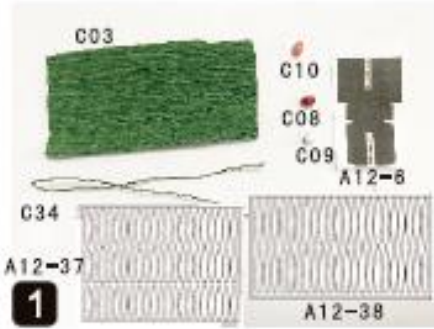

1



6

Potted plant



C21

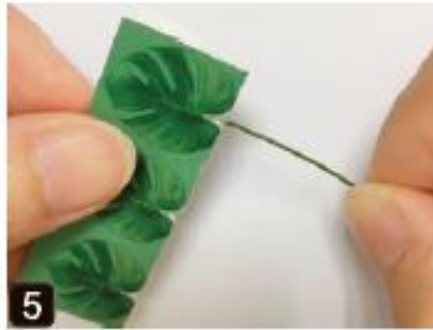

5



1



1



6



2



2



7



3



3



C34: 3cm*2
2.5cm*4
2cm*2



4

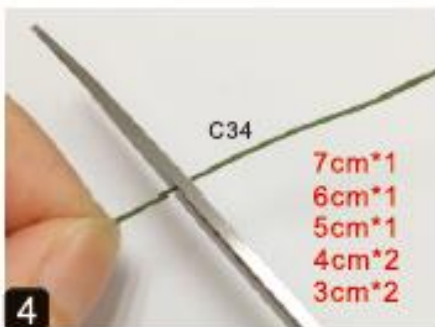

4

7cm*1
6cm*1
5cm*1
4cm*2
3cm*2

The above method is the same, the wire is C34, the parameters and quantity, please refer to above.



Watering kettle



5



6



1



4



7



2



The folding method of paper A12-34 is the same as above steps; Insert tulip after folding the model, flower color random.



8



1



1



9



2



2

The folding method of paper A12-29 is the same as the A12-28.



Paper bag



3



Potted plant

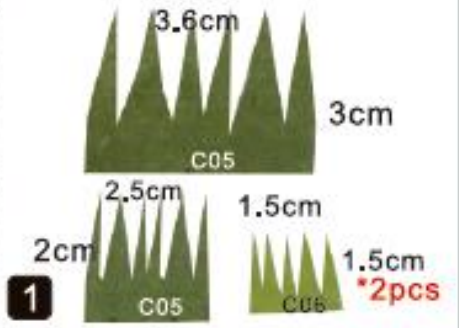
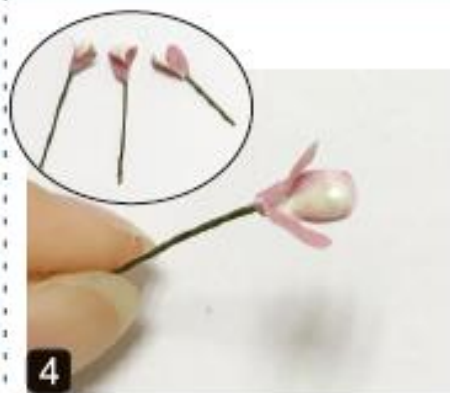

Cut out as shown.



The paper A12-39 is on page 14 of the instructions.

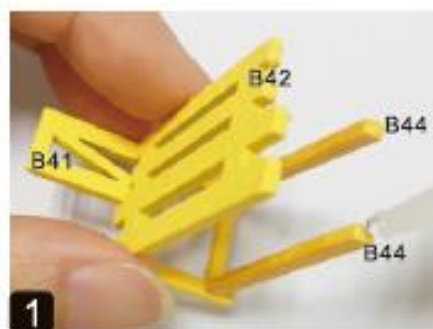



5



3



6



Chair

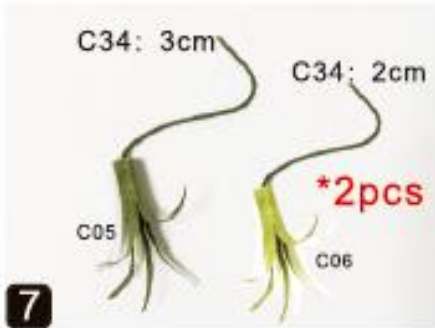

7



1

The paper of A12-40, A12-41, A12-42 are on page 14 of the instructions.



1

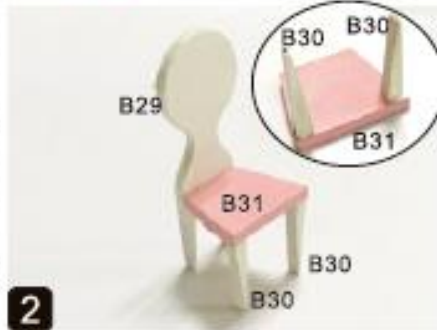

2

The chair need two pieces.



2

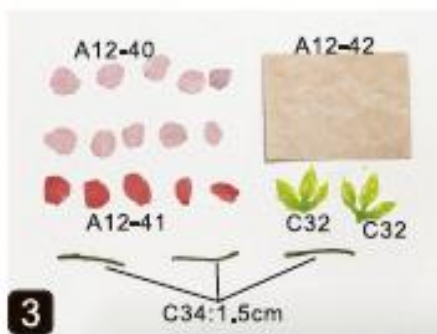

3



4



5



6



7

First, tear off C33 in two single strip.



8

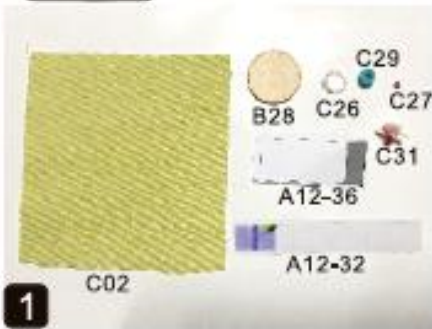
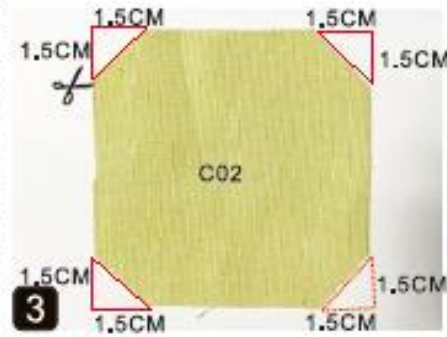
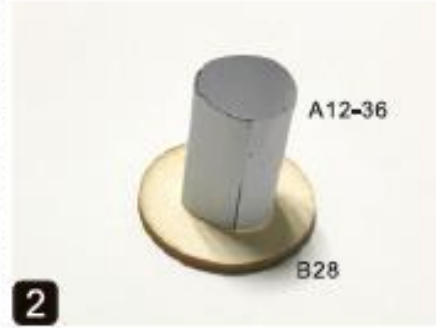



Bed

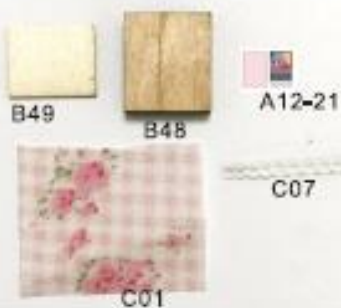

1



2



3



4



A12-21

5

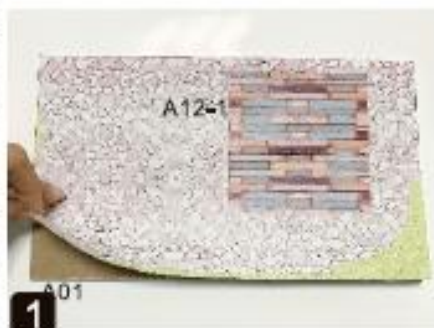

1



2

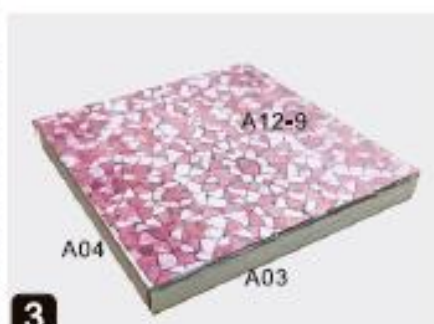

3

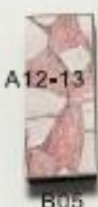

A12-13

4



A12-12

B04



5

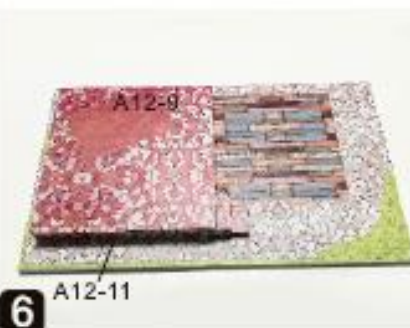

6

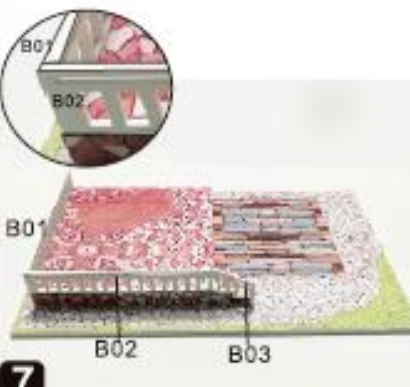

7

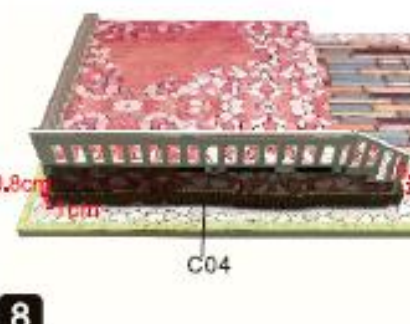

8

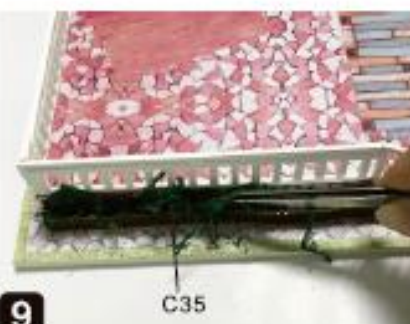

9

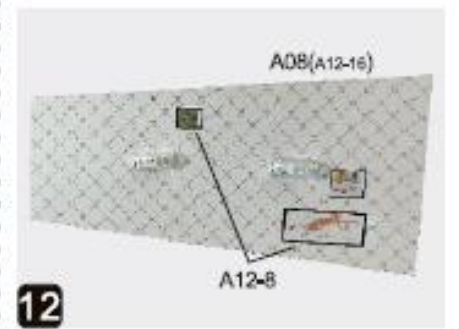
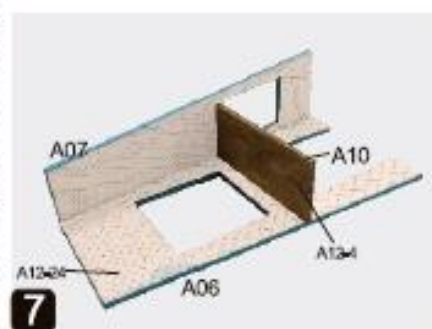
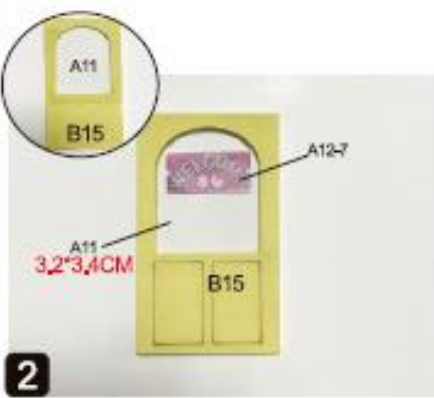
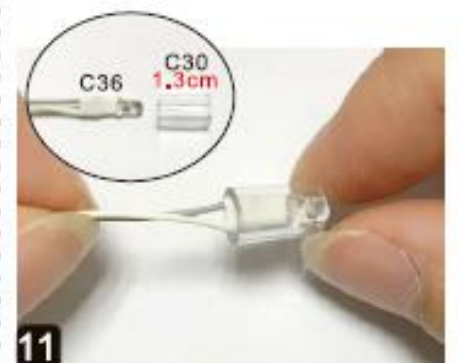
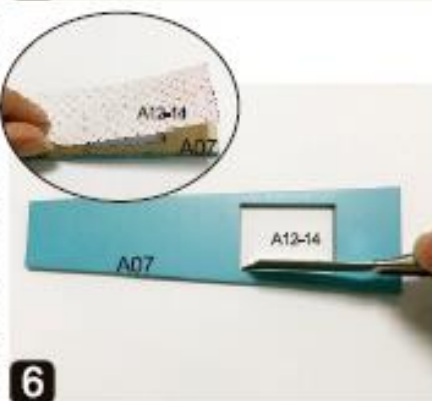
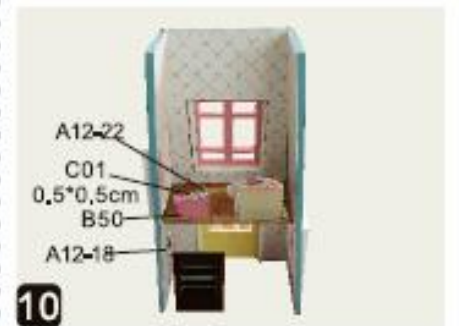
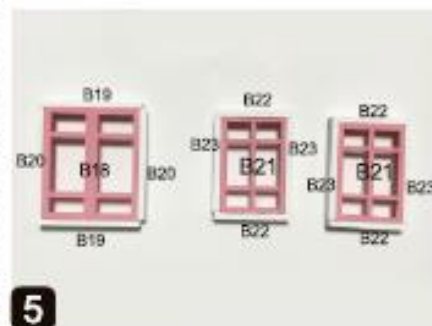
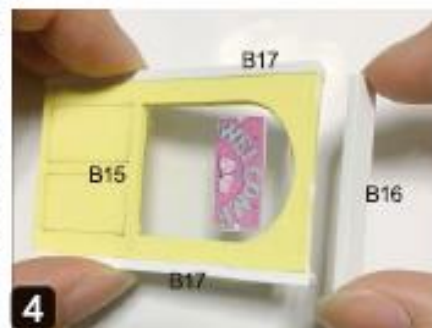
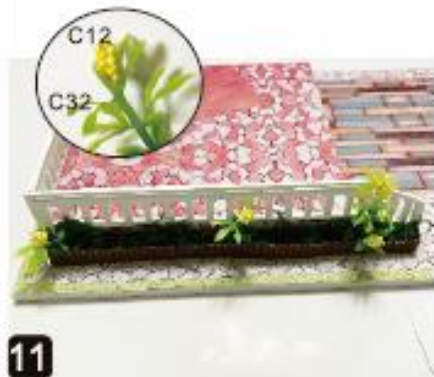
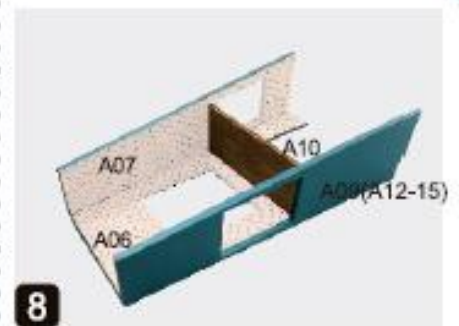

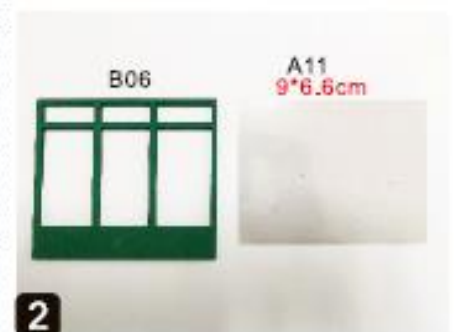
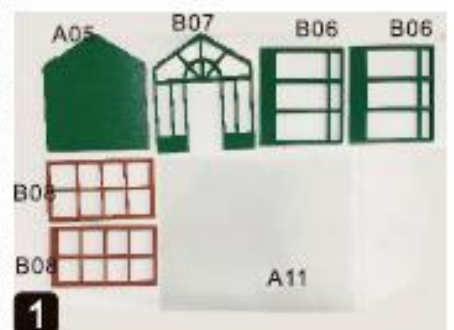
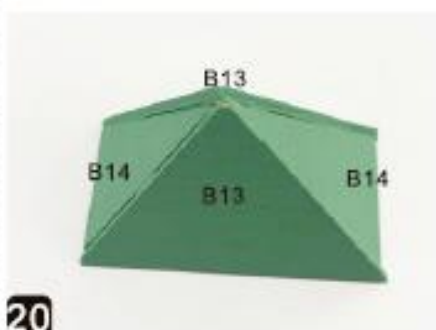
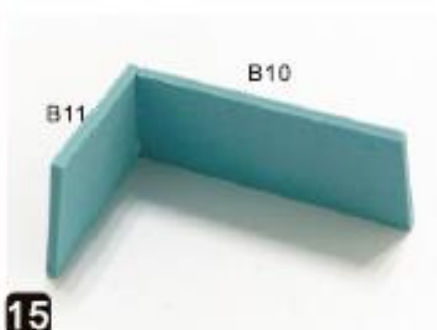
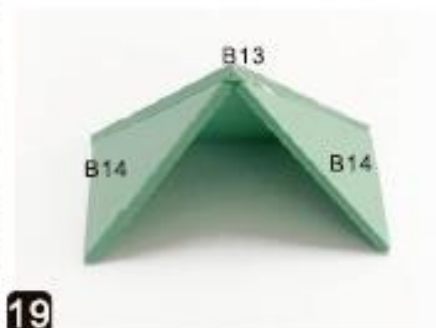
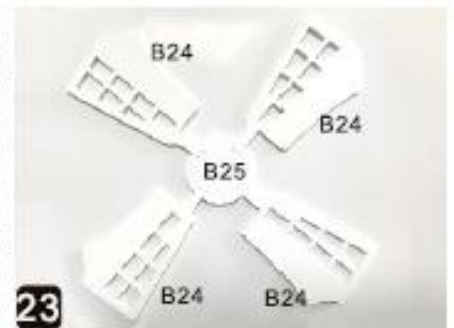
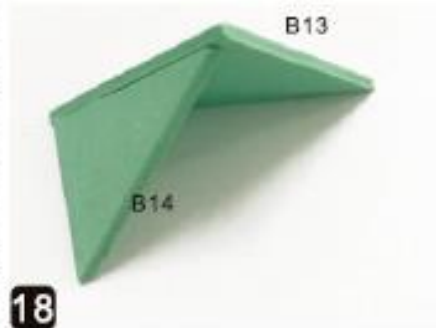

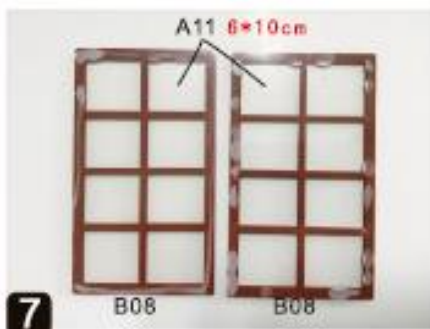

5

2. Use a craft blade to carefully skim over the plastic to bare the copper wire. Twist the same colour wire together.

3. Twist the following wire together:

- (I) BLACK wire from the battery box with the WHITE wire from LED bulb.
- (II) RED wire from the battery box with the GREY wire from LED bulb.

4. Roll and seal the duly twist copper with the white tape provided. Place the battery box in the allocated space.



Statement: the lamp wires cannot be inserted into the output socket.

- Rechargeable batteries should be removed from the toy before charging
- Different types of batteries cannot mix; Do not mix new batteries in use with semi-used batteries.
- Please notice the place of anode and cathode when put in the batteries
- Rechargeable batteries are not blunt electricity
- Rechargeable batteries can only be charged under adult supervision
- Run out of battery should be removed from the toy
- The power shall not be short circuit

4

1. Trim all the LED wiring to the same length.

Installation of dust proof cover
 (For updated version, the parts need to be purchased separately)



D01
 0.2*20.5*26cm
 *2pcs



D02
 0.2*14.4*20.5cm
 *2pcs



D03
 0.2*15*26cm



1. Tear off kraft paper of each piece of transparent cover.

2. Paste D01, D02 and D03 together to complete the dust proof cover as shown.

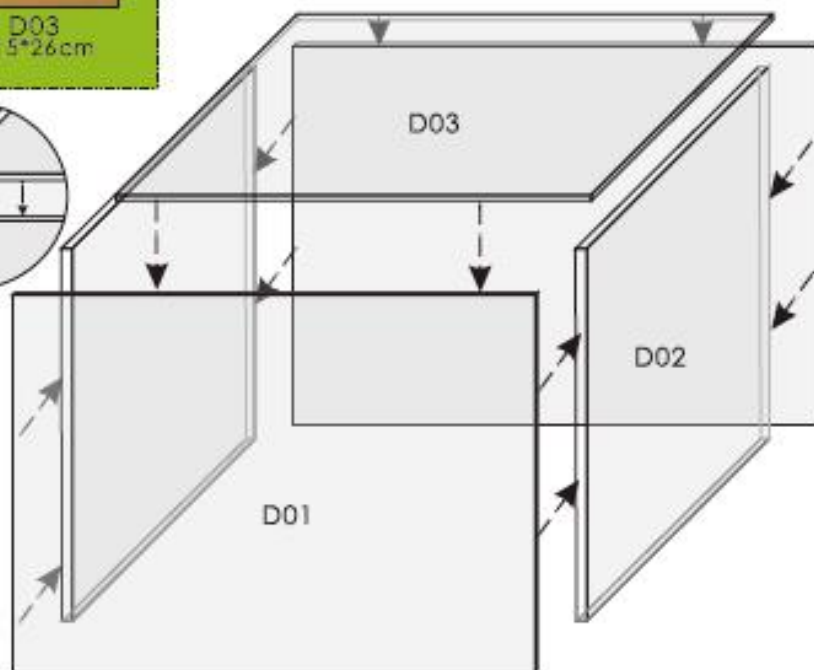
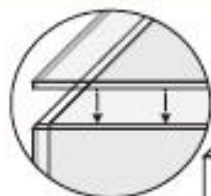

Photo of Dust proof cover



A12-39

Attention: Please keep the instruction manual for future enquires after installation.

