

M030

DIY handmade goods—

Enjoy the romantic Nordic



Instruction Manual

# NOTICE OF ASSEMBLE

## Making tips

1. LED wiring indication: White=Positive; Grey=Negative.
2. Use a craft blade to carefully skim over the plastic to bare the copper wire.
3. For LED wiring extension, please refer to the below steps:

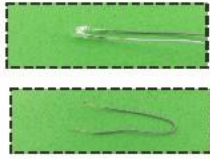

Twist the copper of both LED wire and extension wire together.



Do the same on the white wire.  
Remarks: Tie a knot at the end of the grey wire to differentiate the polarity.

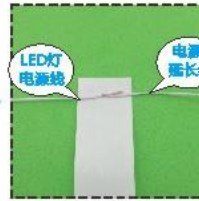

Place the duly twist wire on the tapes provided.



Roll and wrap the wire.

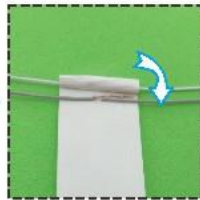

Place another wire next to it.  
Remarks: DO NOT contact both copper wire to avoid short circuit.



Roll and wrap it together.

## Warnings

- The product is not suitable for children under 14 years old. They should be under custody of adults when playing with the product.
- There are small parts, please do not swallow them for avoiding dangerous accidents.
- Please also pay attention to the sharp-pointed materials to avoid injuries.

## Tips for assembling

1. Pictures shown on the package may be slightly different from the actual product.
2. Please use the provided tracing paper for cutting purpose to achieve the best outcome.
3. Product designs and specification may be subject to change without advance notice for purpose of making improvement.
4. Testing on LED function:



DO NOT contact the LED wire end direct to the battery cell.



Use the provide battery holder. Make sure the correct polarity.

## How to assemble the remote control lamp



1. Material needed:  
- Remote controller, receiver, LED bulb, tape and 3 pieces button battery. (provided)

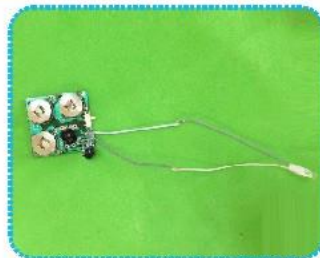

2. Connect the red wire to grey wire. Connect the black wire to white wire.

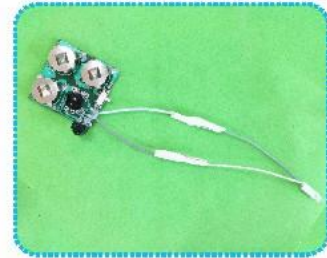

3. Wrap the exposed wire with the tapes.

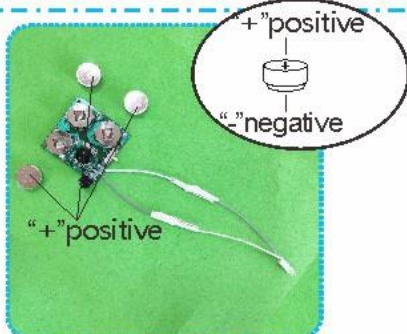

4. Insert the battery take notes on the polarity.

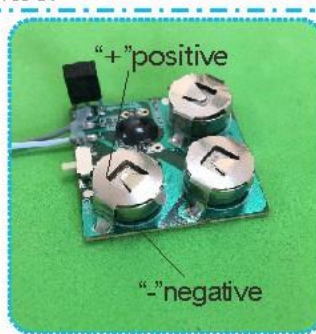

5. Bend the sheet iron on receiver as shown.

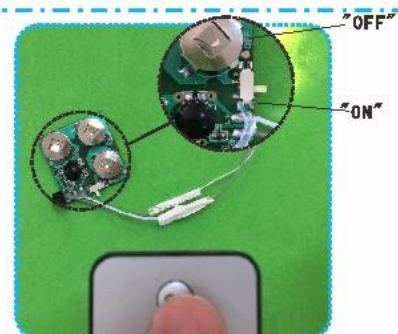

6. The remote controller aimed at receiver, press the ON button key to light.

# Product information

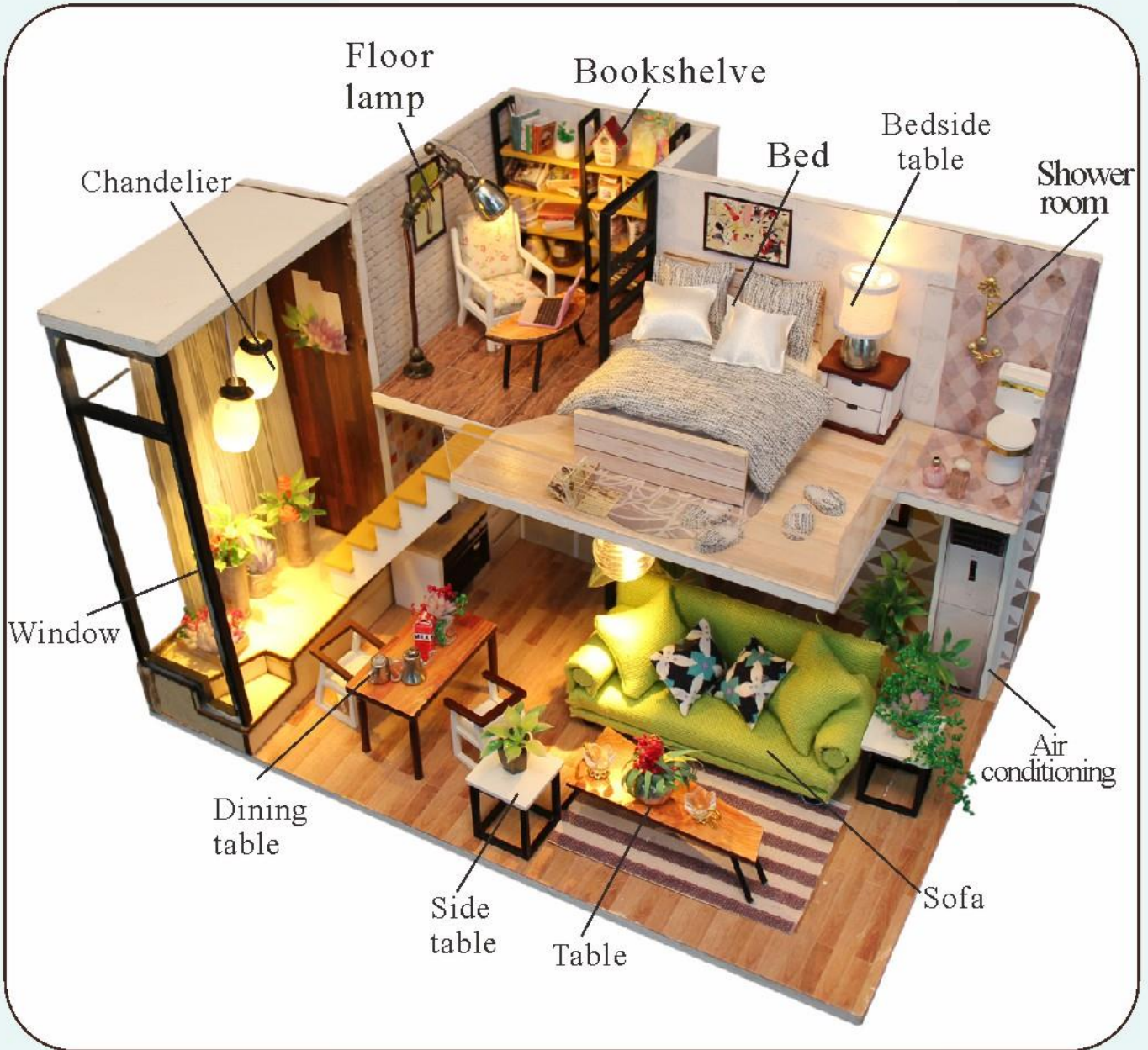

# Bookshelve



# Decorating

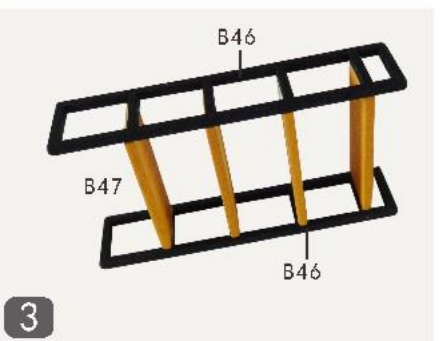
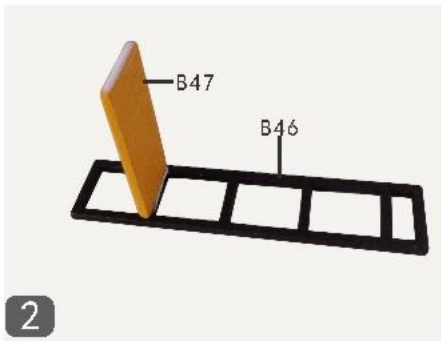
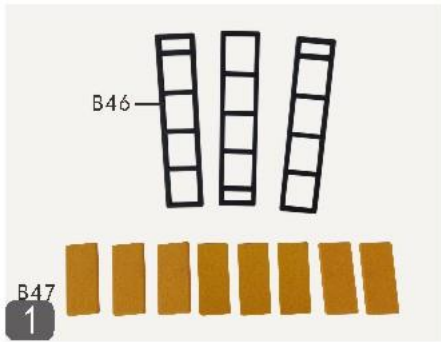
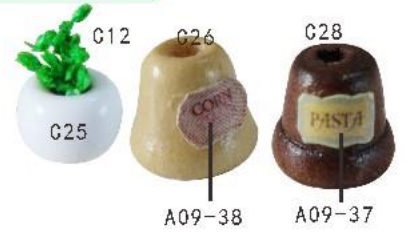

The book making method is same as above.

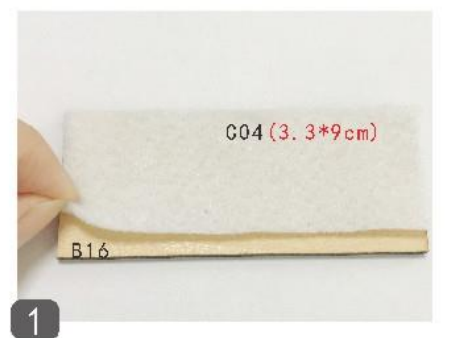
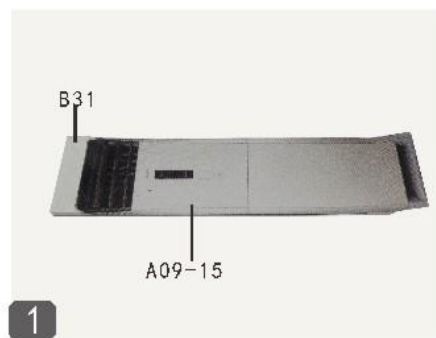
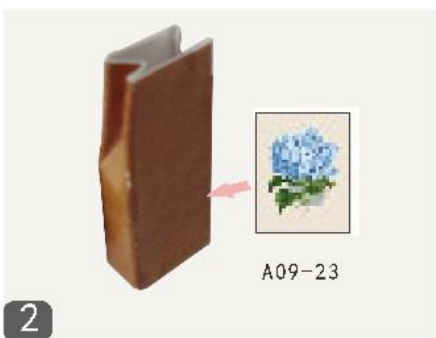
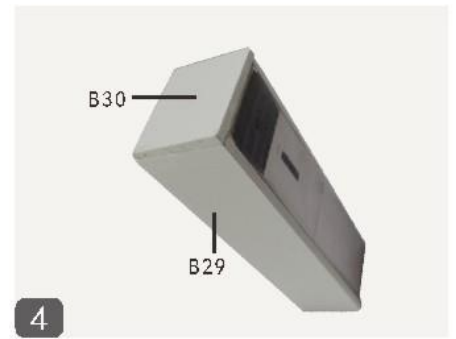
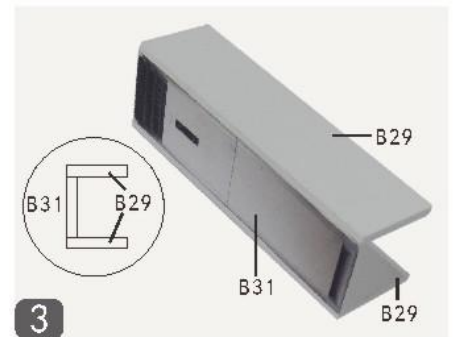
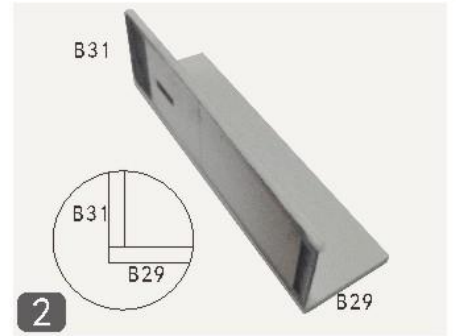
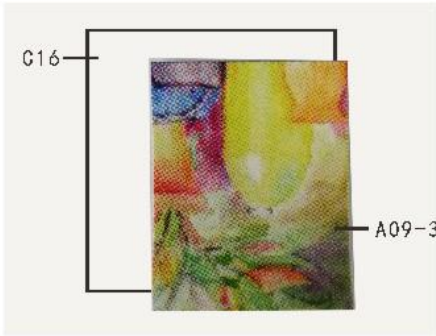

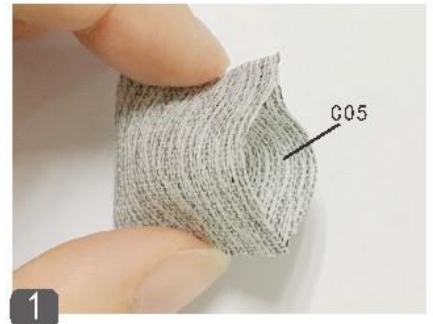
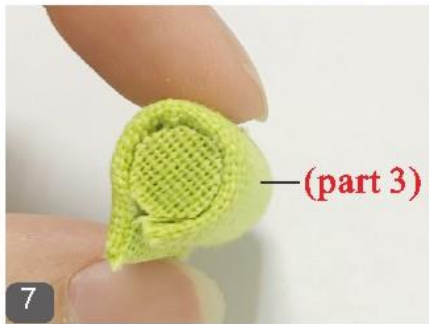

1 Cut off C05 with size 3\*6cm, and fold it half as shown.

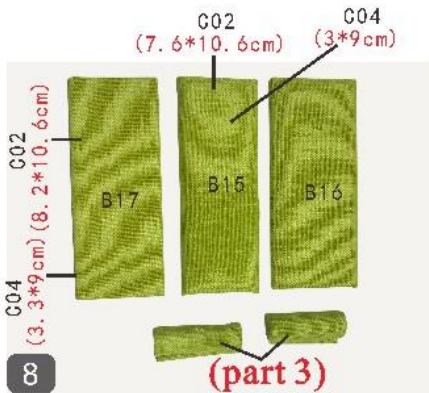

8 According the step 1-3 to do the B17,B15.

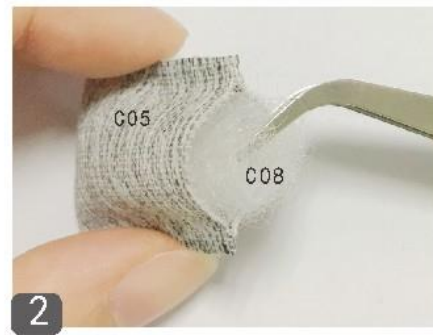

2 Insert some cotton to C08 as shown. Apply the glue on the top and fix it as shown the pillow is done.

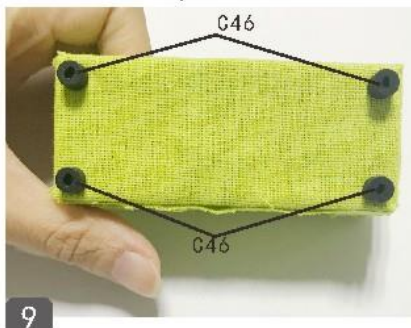
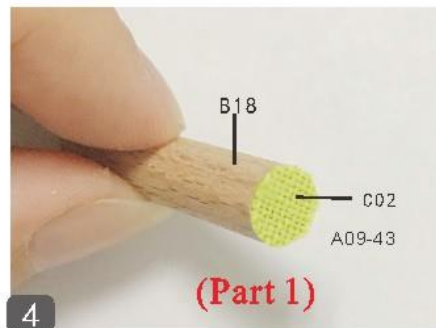

Bed

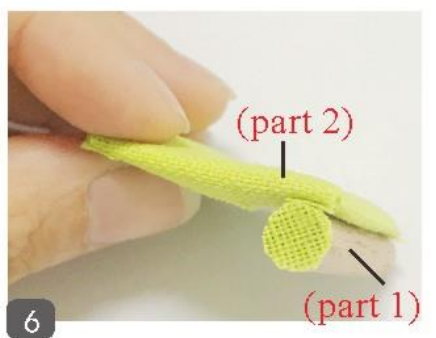
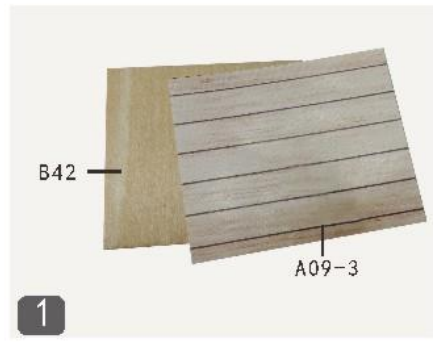
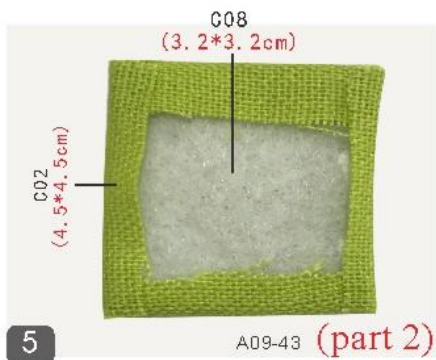

Pillow





### Side table

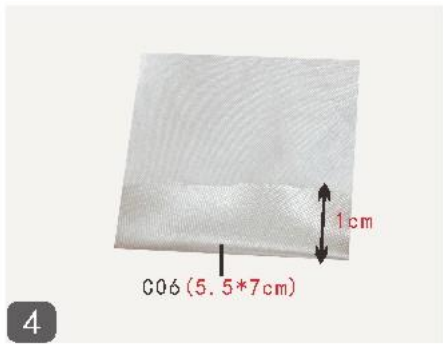

### Table

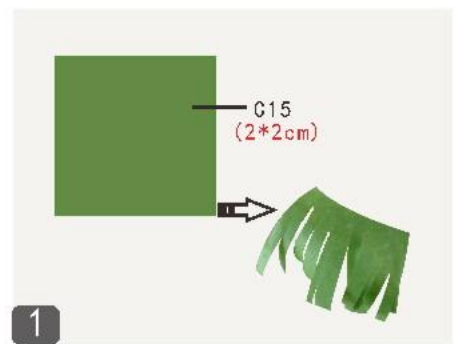
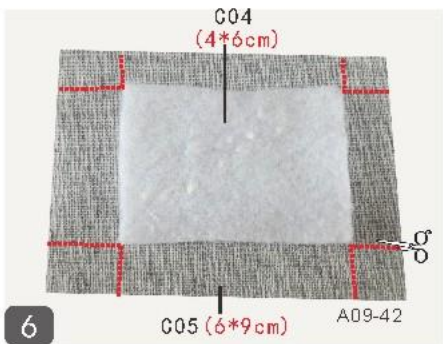
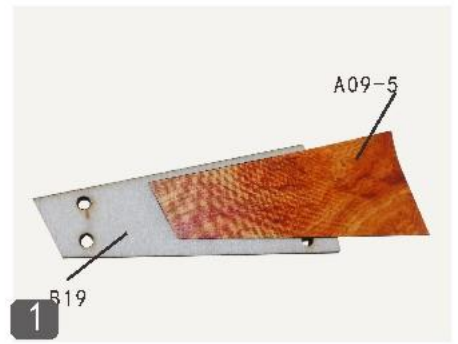
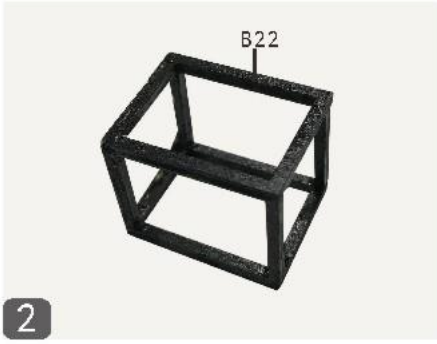

# Dining Table



2



1



A09-36



G11

G23

3



A09-17

B24

1



2



G20  
(1.5cm)

G32

G33

1



B25

B25

2



3

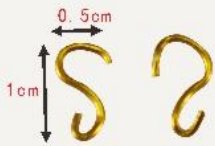

0.5cm

1cm

G20: 1.5cm

2

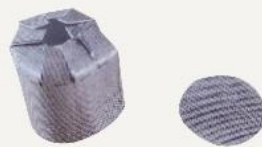

A09-20

1



0.4cm

0.5cm

G21: 1cm

1



G32

G20

G33

3



G10

A09-20

2



G30

2



### Table



### Chair

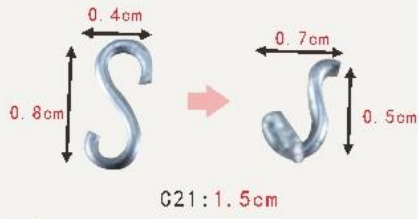

3



4



1

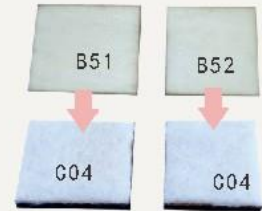

1

Attach C04 on B51 and B52 as shown.

### Dining chair



2



2

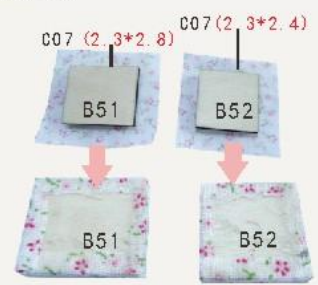

2



1

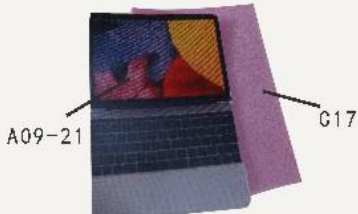

3



3



2



4

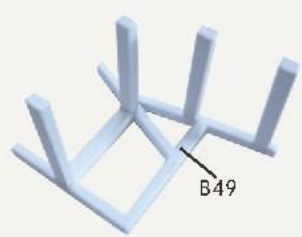

4

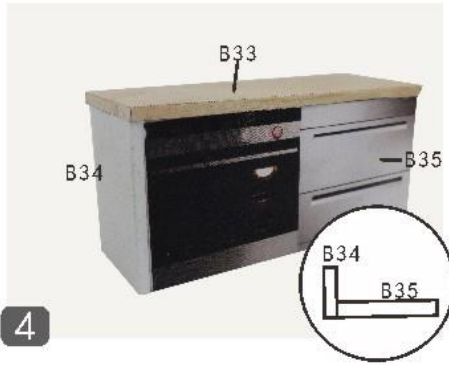
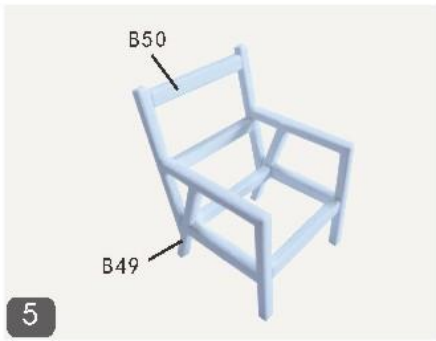

Cabinety

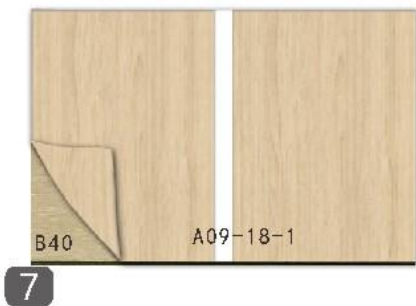
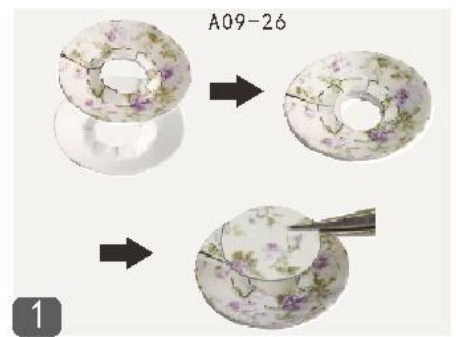
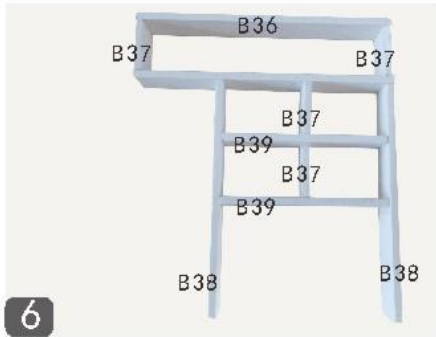
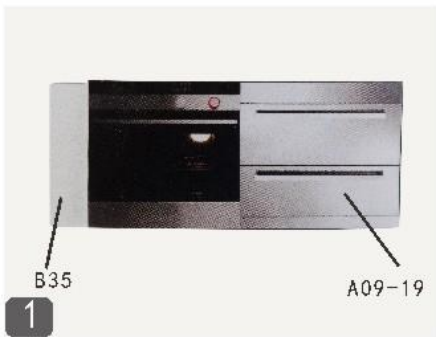
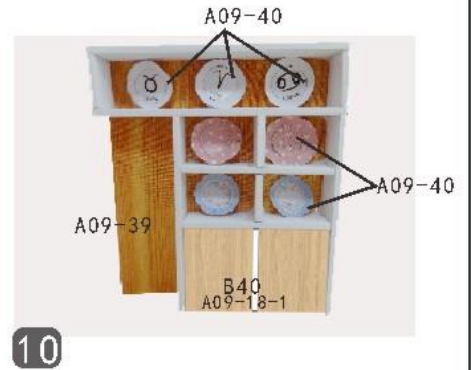
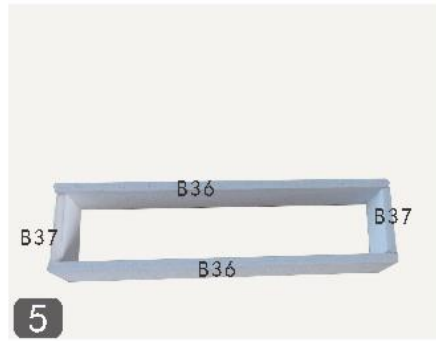

Bathroom



Potted plant

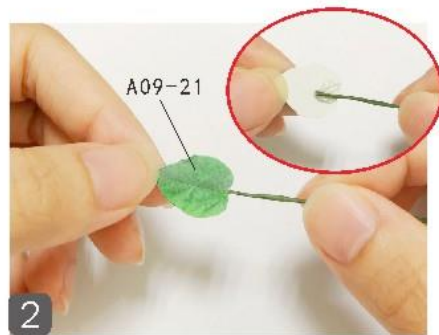
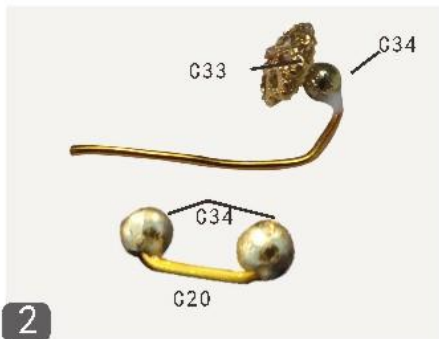
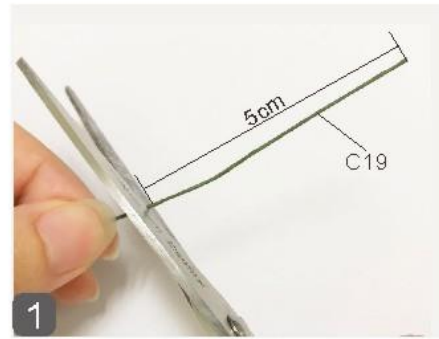
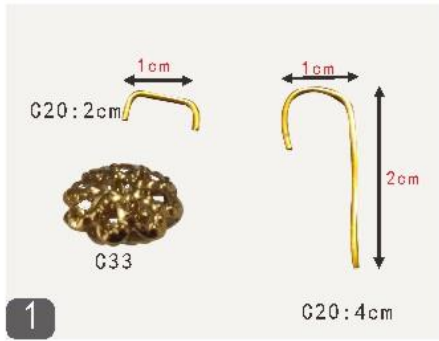
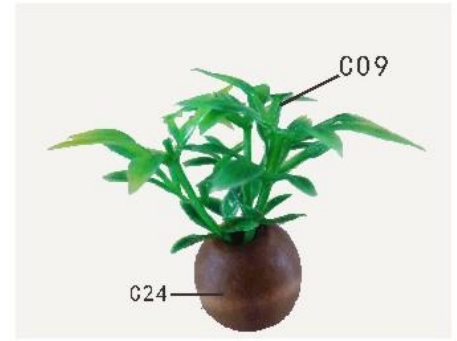
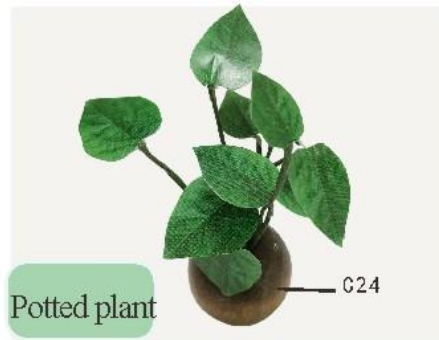

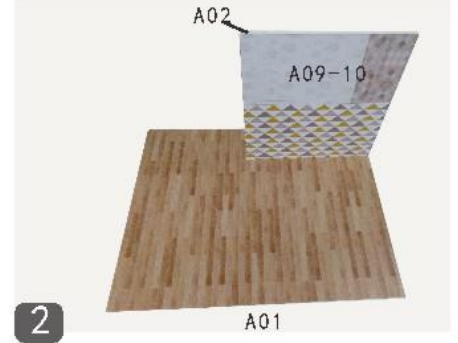
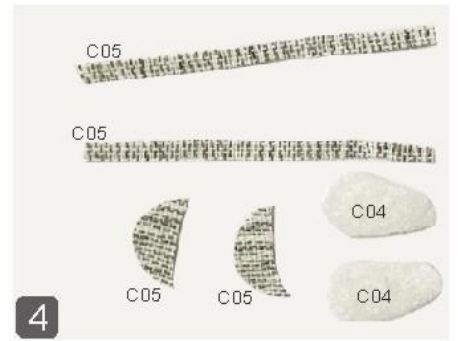
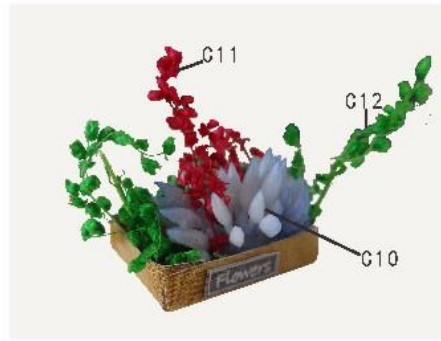
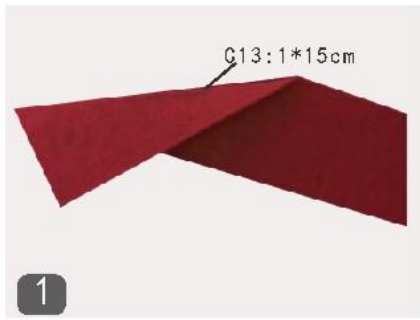

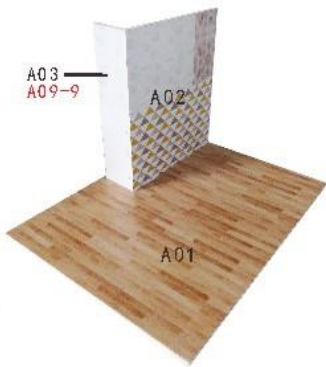

3

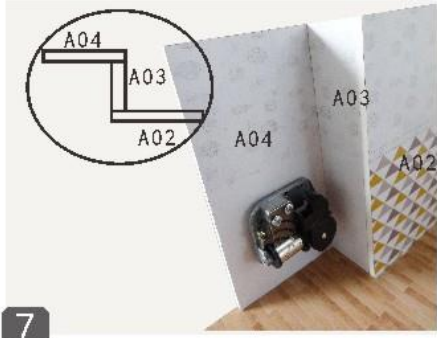

7

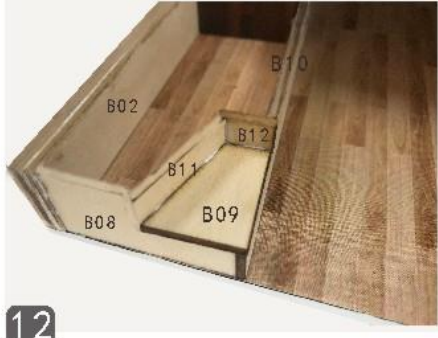

12

**Music machine core manual guide**  
(If you have purchased the music machine core, please fix it firstly)



F01 Music machine core 1piece



F02 Screw 3pieces



F03 Music machine core handle 1piece

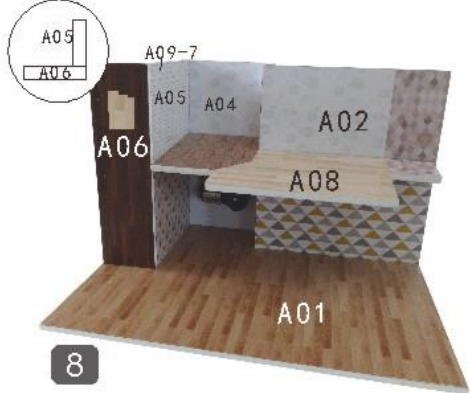

8



13

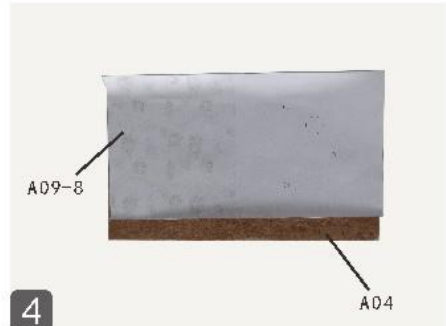

4

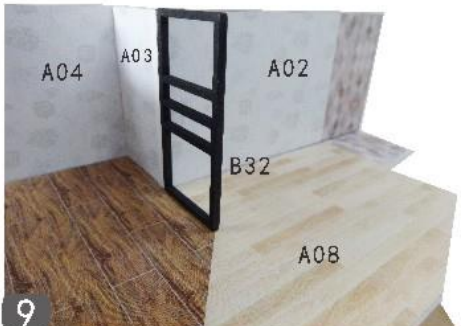

9



14



5

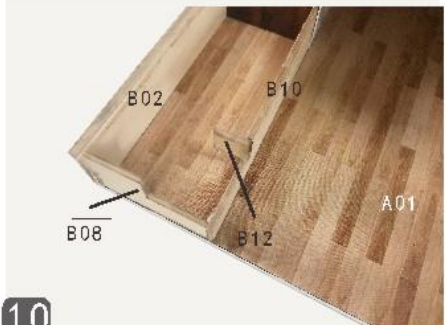

10

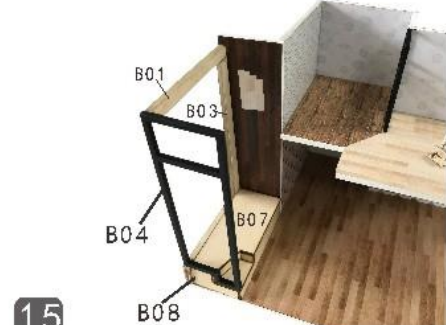

15

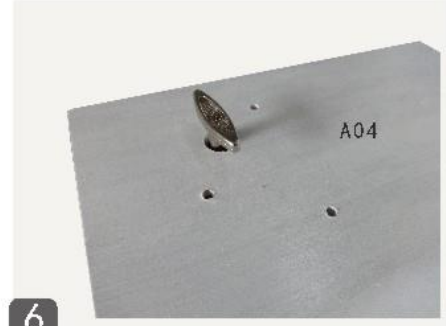

6

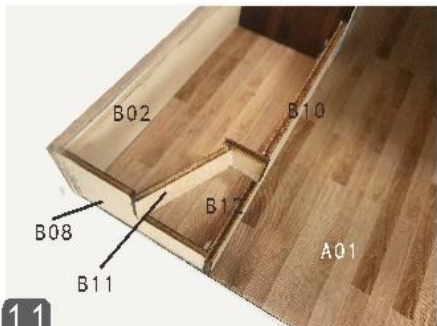

11

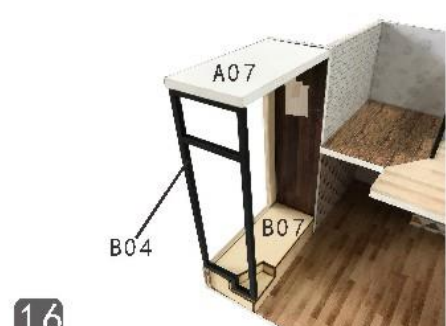

16

Fix F01, F02 and F03 on A08 as shown.

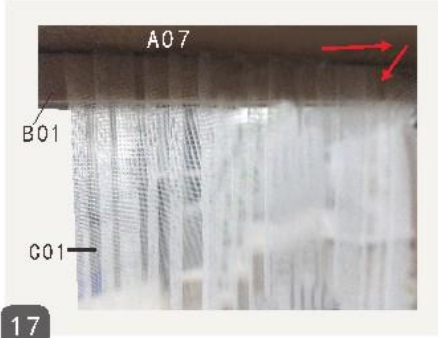

17

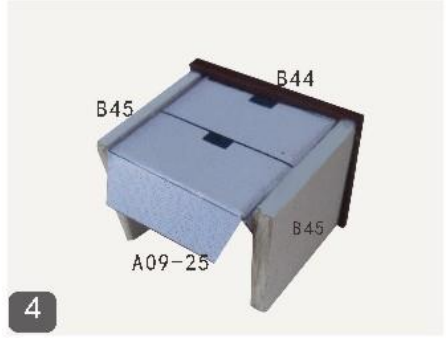

4



18

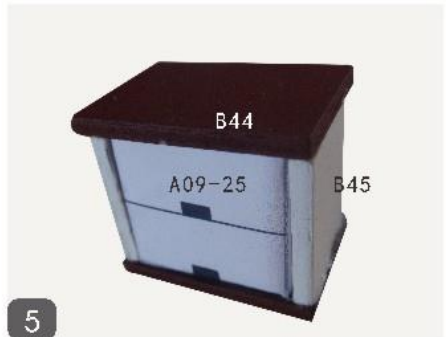

5

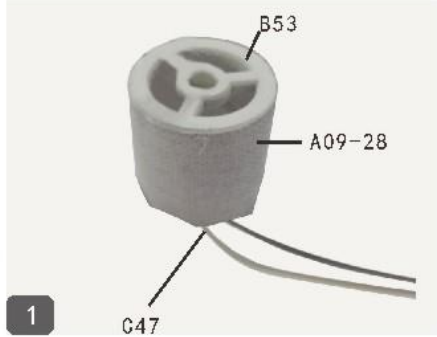
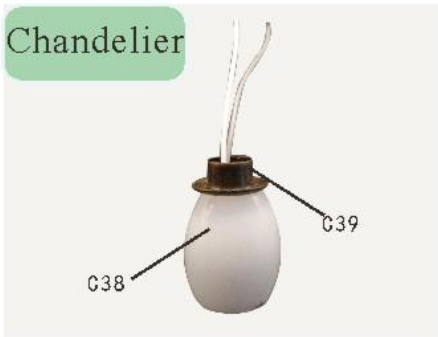

1

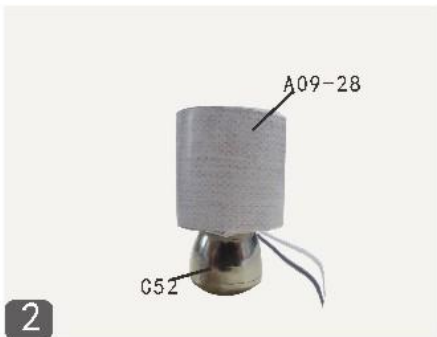
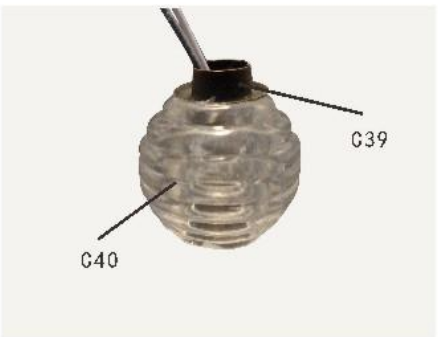

2

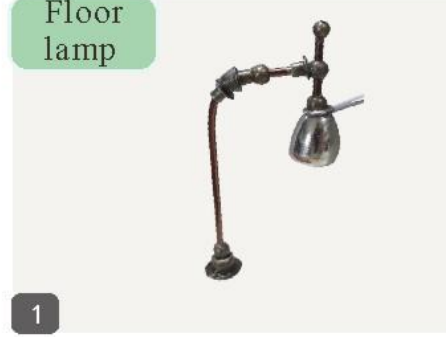

1

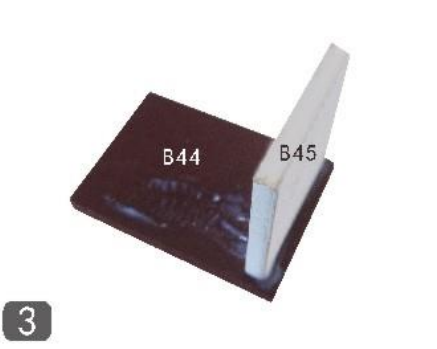

3

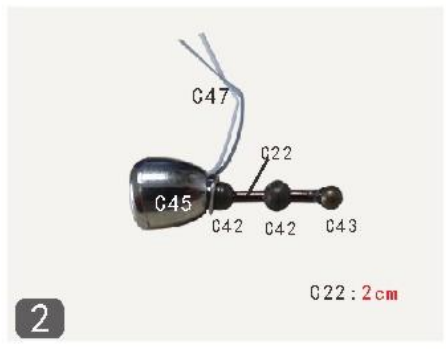

2

C22: 2cm

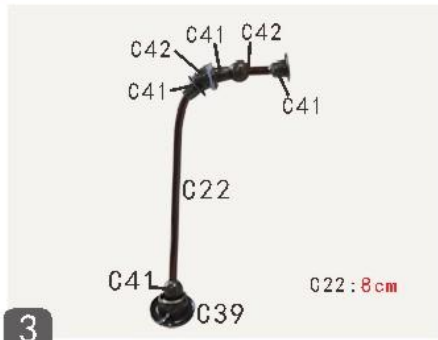

3



4

### Bathroom



Draw the line with a small knife

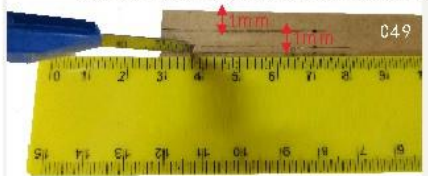

Draw 3 straight lines on C49 and C48 with a knife as above shown.

Tear off kraft paper of each piece of transparent cover.

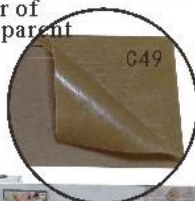

Attach C48, C49, C50 and C51 well as shown.



1. Trim all the LED wiring to the same length.



2. Use a craft blade to carefully skim over the plastic to bare the copper wire. Twist the same colour wire together.

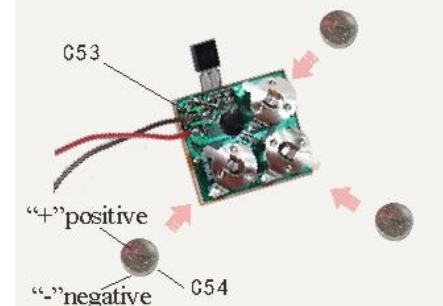

Insert the battery C54 on receiver C53, please pay attention the polarity.

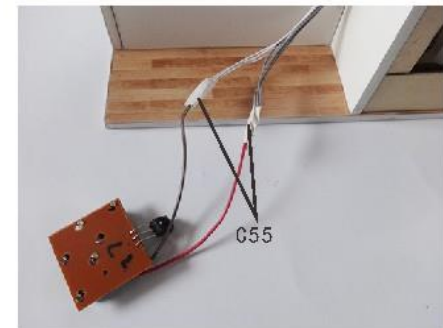

3. Twist the following wire together:  
 (I) BLACK wire from the battery box with the WHITE wire from LED bulb.  
 (II) RED wire from the battery box with the GREY wire from LED bulb.



Take out the paper as above.  
 "ON" means to turn on the lights  
 "OFF" means turning off the lights.

### Stair

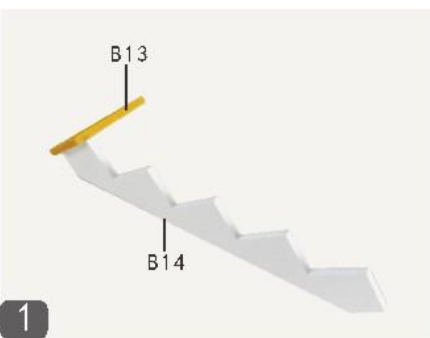

1

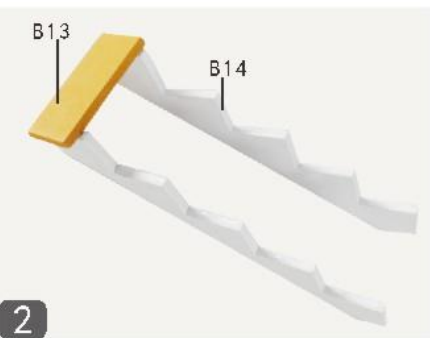

2

### How to connect to battery box

**Statement: the lamp wires cannot be inserted into the output socket.**

- Please notice the place of anode and cathode when pit in the batteries
- Rechargeable batteries are not blunt electricity
- Rechargeable batteries can only be charged under adult supervision
- Rechargeable batteries should be removed from the toy before charging
- Different types of batteries cannot mix; Do not mix new batteries in use with semi-used batteries.



Install bedside table lamp and fix power wires along the yellow dotted lines.  
 Install floor lamp and fix power wires along the red dotted lines.  
 Install chandelier and fix power wires along the green dotted lines.

## Installation of dust proof cover



F04 Transparent cover 0.15\*20\*27 (1piece)  
F05 Transparent cover 0.15\*16.5\*26.7 (2piece)  
F06 Transparent cover 0.15\*16.5\*20 (2piece)

**(For updated version, the parts need to be purchased separately)**

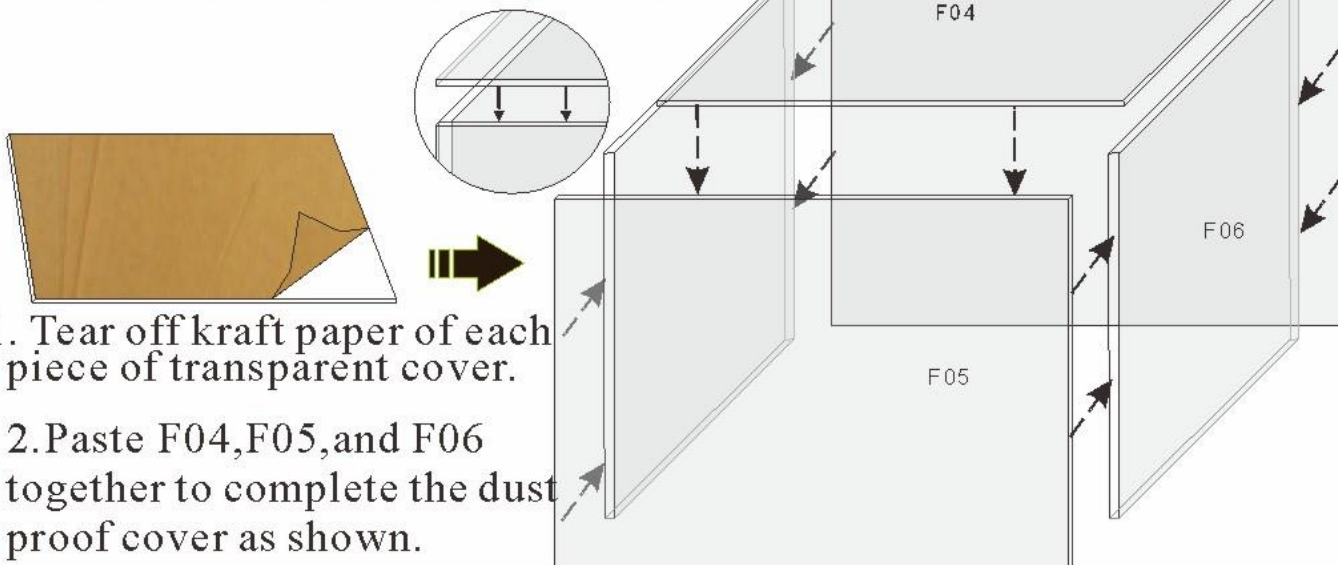

1. Tear off kraft paper of each piece of transparent cover.
2. Paste F04, F05, and F06 together to complete the dust proof cover as shown.

## Photo of Dust proof cover



**Attention: Please keep the instruction manual for future enquires after installation.**



# M030 Material list(2-1)

## Material Bag A(Ratio 1:2)

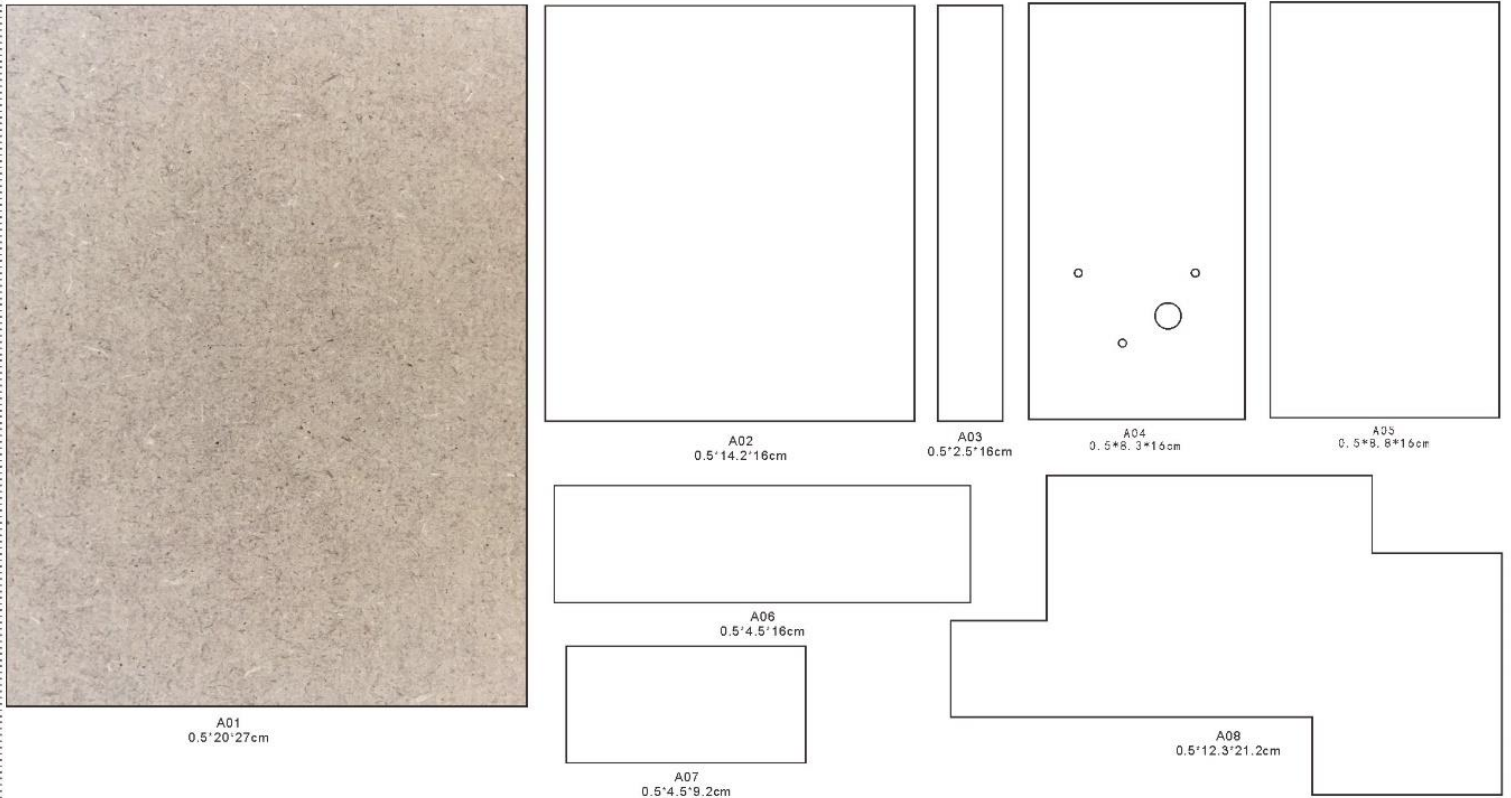

## Material Bag B(Ratio 1:1)



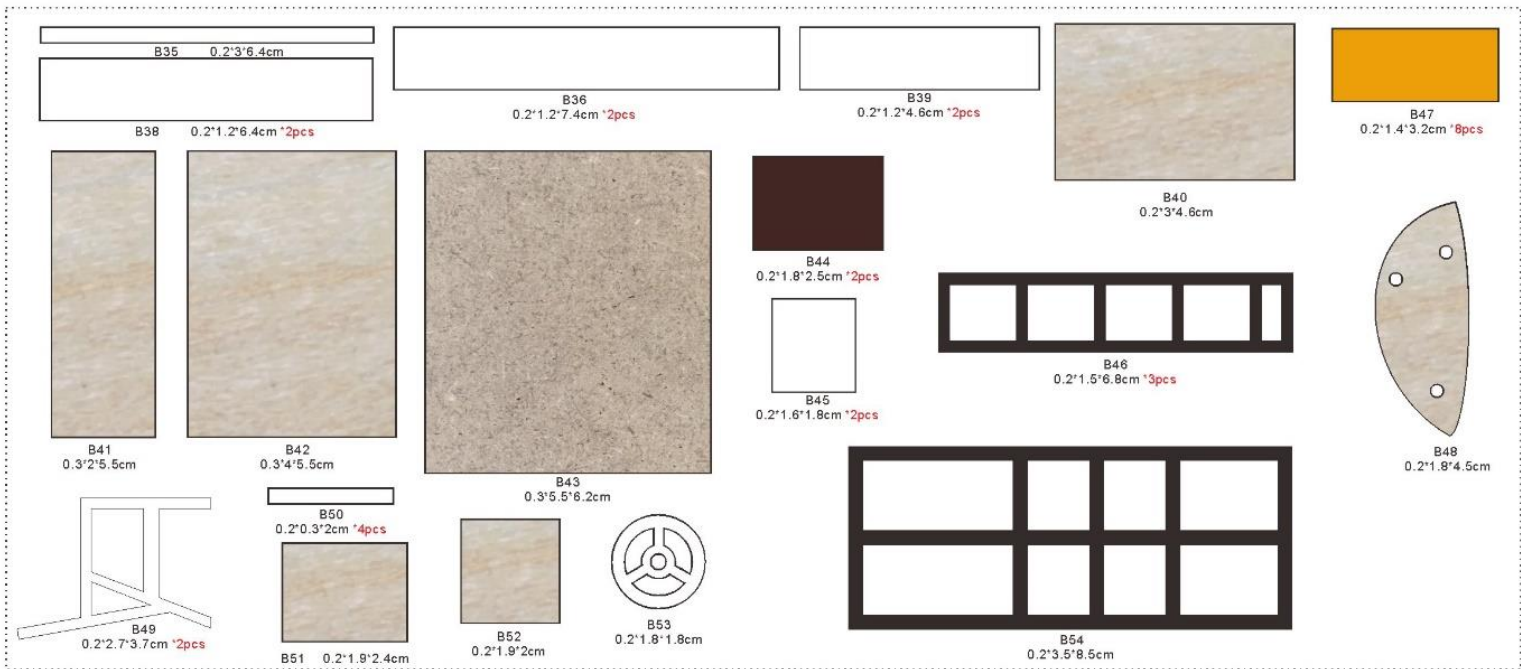

## Material Bag C

C01 6'23cm	C02 15'23cm	C03 6'6cm	C04 10'18cm	C05 8'10cm	C06 8'8cm	C07 4'9cm	C08 若干	C09 *2pcs	C10 *1pcs	C11 Some
C12 Some	C13 5'8cm	C14 3'5cm	C15 3'5cm	C16 8'10cm	C17 2'4cm	C18 5'15cm	C19 70cm	C20 8cm	C21 5cm	C22 10cm
C23	C24 *2pcs	C25	C26	C27	C28	C29	C30	C31	C32 *2pcs	C33 *4pcs
C34 *5pcs	C35 *2pcs	C36	C37	C38 *2pcs	C39 *4pcs	C40	C41 *3pcs	C42 *5pcs	C43	C44
C45 *2pcs	C46 *4pcs	C47	C48 2'12.5cm	C49 2'5.3cm	C50 3.9'6.9cm	C51 3.5'6.9cm	C52 *5pcs	C53	C54 *3pcs	C55