

Blissful Corner Serie

Adabelle's Room



M013 User Manual

Notes: The product has a dustproof cover which is composed of three pieces of organic glass.
Timber, cloth and bead might be slightly different between batches, please refer to the real product for detailed information.

Front view when turning lights on

1



Warm prompt

Warnings:

Please do not allow infants and young children to play with the package for avoiding dangerous accidents! The product must be taken out by adults and then played by children. Children must be under the custody of adults when playing with the Product. Necessary Tools

Necessary Tools

(Tools are not included in the packing list and should be prepared by users)







Tips for assembling

- ① Please read the user manual carefully before assembling.
- ② Firstly polish corners of wooden materials by sandpaper, and then assemble every part tidily according to Part Number.
- ③ Use tweezers to help pasting tiny materials.
- ④ Use pliers to shape iron wire.
- ⑤ Dotted lines on paper accessories are folding line, and grey parts are for pasting.
- ⑥ It is suggested to paste paper accessories by double faced adhesive tape.

Material Bag A







2

Unit: cm

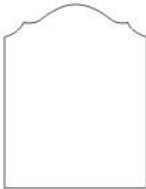
				
A01 medium density Fiberboard (wood color, white edge) 14.5*10.5*0.5 (1piece)	A02 medium density fiberboard (white) 14.1*11.7*0.5 (1 piece)	A03 medium density fiberboard (white) 11.7*10.5*0.5 (1 piece)	A04 paper accessory	A05 glue (1 piece)

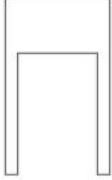
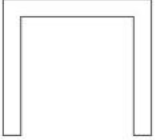
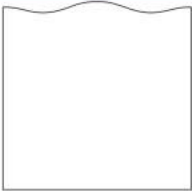
Material Bag B







Unit: cm

				
B01 timber block (white) 4.6*4*0.2 (1 piece)	B02 timber block (white) 3.7*2*0.2 (2 pieces)	B03 timber (white) 4*1*0.2 (1 piece)	B04 timber block (white) 5.8*4.5*0.3 (1 piece)	B05 timber (white) 5.8*0.4*0.4 (2 pieces)
				
B06 timber (wood color) 8*5.3*0.3 (1 piece)	B07 timber (wood color) 7.6*1.8*0.2 (2 pieces)	B08 timber (wood color) 5.3*1.8*0.2 (1 piece)	B09 timber (white) 5*2.8*0.4 (1 piece)	B10 timber (white) 4.2*2.5*0.4 (2 pieces)
				
B11 timber (white) 3.8*1.3*0.2 (1 piece)	B12 timber block (white) 1.5*0.9*0.2 (2 pieces)	B13 timber block (white) 5.2*2.4*0.3 (1 piece)	B14 timber (white) 2.5*1.8*0.2 (1 piece)	B15 timber block (white) 2.5*2.3*0.3 (1 piece)
				
B16 timber (white) 1.8*0.3*0.3 (2 pieces)	B17 timber block (white) 4.2*4.2*0.2 (1 piece)	B18 timber (white) 4.2*1*0.2 (3 pieces)	B19 timber block (white) 4.2*1.2*0.2 (2 pieces)	B20 timber (light green) 3*2.5*0.2 (2 pieces)
				
B20 timber (light green) 3.5*2.2*0.2 (3 pieces)	B22 timber (light green) 2.2*1.5*0.2 (2 pieces)		C41 sand paper (1 piece)	C42 gummed paper (1 piece)

Material Bag C

3

Unit: cm

				
<p>C01 white non-woven fabrics 9*10 (1 piece)</p>	<p>C02 white printed cloth 11*16 (1 piece)</p>	<p>C03 big white lace 14cm (1 piece)</p>	<p>C04 white lace 11cm (1 piece)</p>	<p>C05 blue dotted cloth 6*12 (1 piece)</p>
				
<p>C06 pink dotted cloth 6*9 (1 piece)</p>	<p>C07 wadding (some)</p>	<p>C08 white paperboard 8*12 (1 piece)</p>	<p>C09 pink round plastic bead (1 piece)</p>	<p>C10 golden small torus (1 piece)</p>
				
<p>C11 golden rhombus bead (1 piece)</p>	<p>C12 red round plastic bead (1 piece)</p>	<p>C13 red rhombus bead (1 piece)</p>	<p>C14 pink cylindrical bead (1 piece)</p>	<p>C15 blue round bead (1 piece)</p>
				
<p>C16 green pipe bead (2 pieces)</p>	<p>C17 golden bead chain 15cm (1 piece)</p>	<p>C18 white flower shaped bead (1 piece)</p>	<p>C19 golden round bead (1 piece)</p>	<p>C20 pink plastic bead (1 piece)</p>
				
<p>C21 white heart shaped bead (1 piece)</p>	<p>C22 transparent flower shaped bead (1 piece)</p>	<p>C23 blue round bead (1 piece)</p>	<p>C24 red starlike plastic bead (1 piece)</p>	<p>C25 colorful heart shaped bead (1 piece)</p>
				
<p>C26 transparent polygon bead (1 piece)</p>	<p>C27 pink rhombus bead (1 piece)</p>	<p>C28 white flowerpot (1 piece)</p>	<p>C29 light green bouquet (3 pieces)</p>	<p>C30 yellow plastic Bead (1 piece)</p>
				
<p>C31 yellow sponge (1 piece)</p>	<p>C32 yellow non-woven fabrics 1*1 (1 piece)</p>	<p>C33 golden torus (3 pieces)</p>	<p>C34 white iron wire 16cm (1 piece)</p>	<p>C35 white lace (1 piece)</p>
				
<p>C36 transparent flower shaped bead</p>	<p>C37 white pearl (6 pieces)</p>	<p>C38 bulb wire 30cm (2 pieces)</p>	<p>C39 battery box (1 piece)</p>	<p>C40 balck screw for battery box (1 piece)</p>

Outer Frame

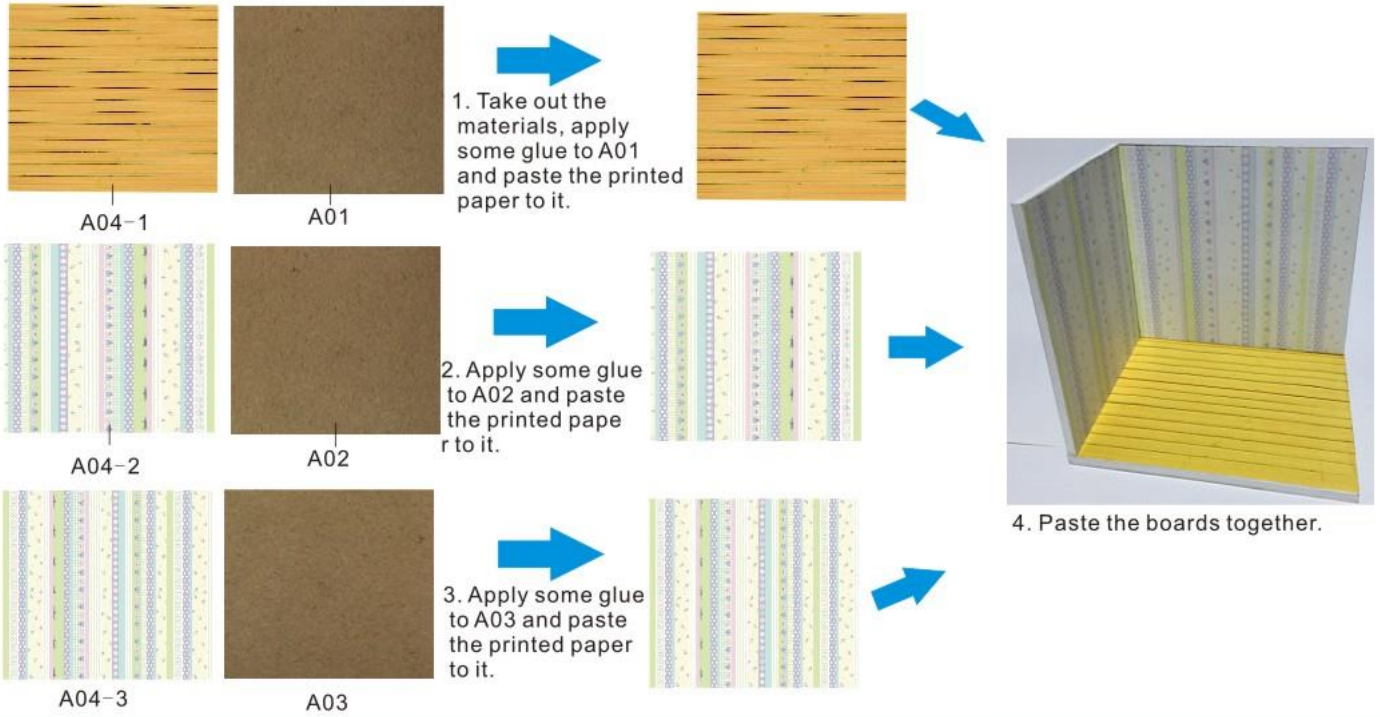

Bed



Beside Table

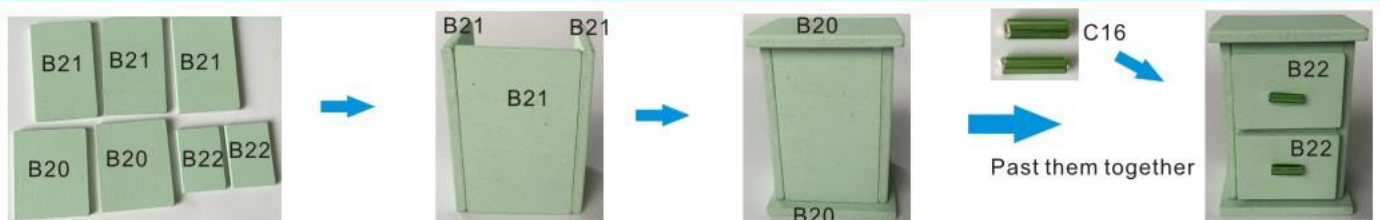

Window

5

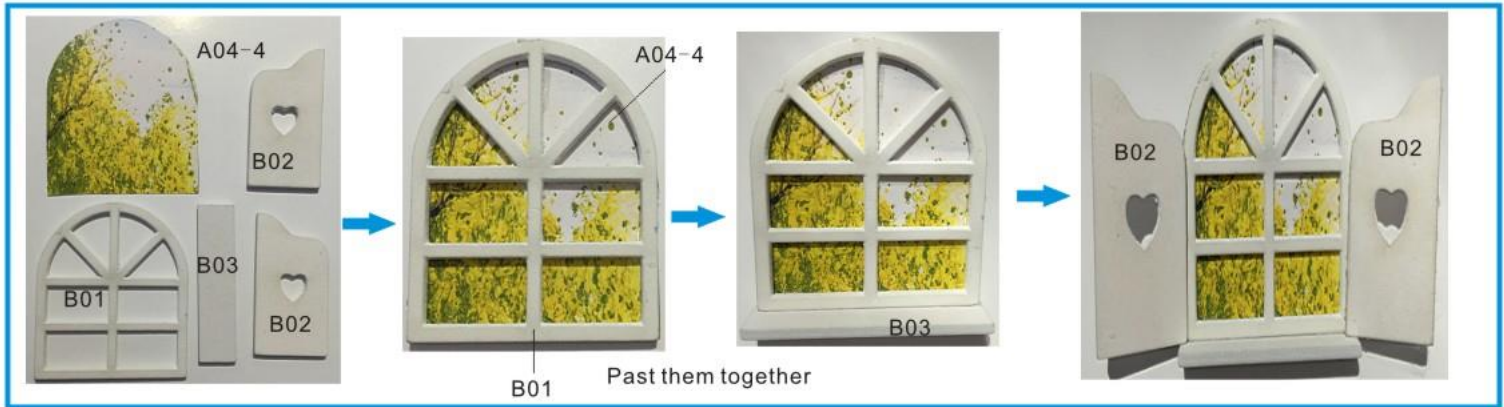

Wall Lamp

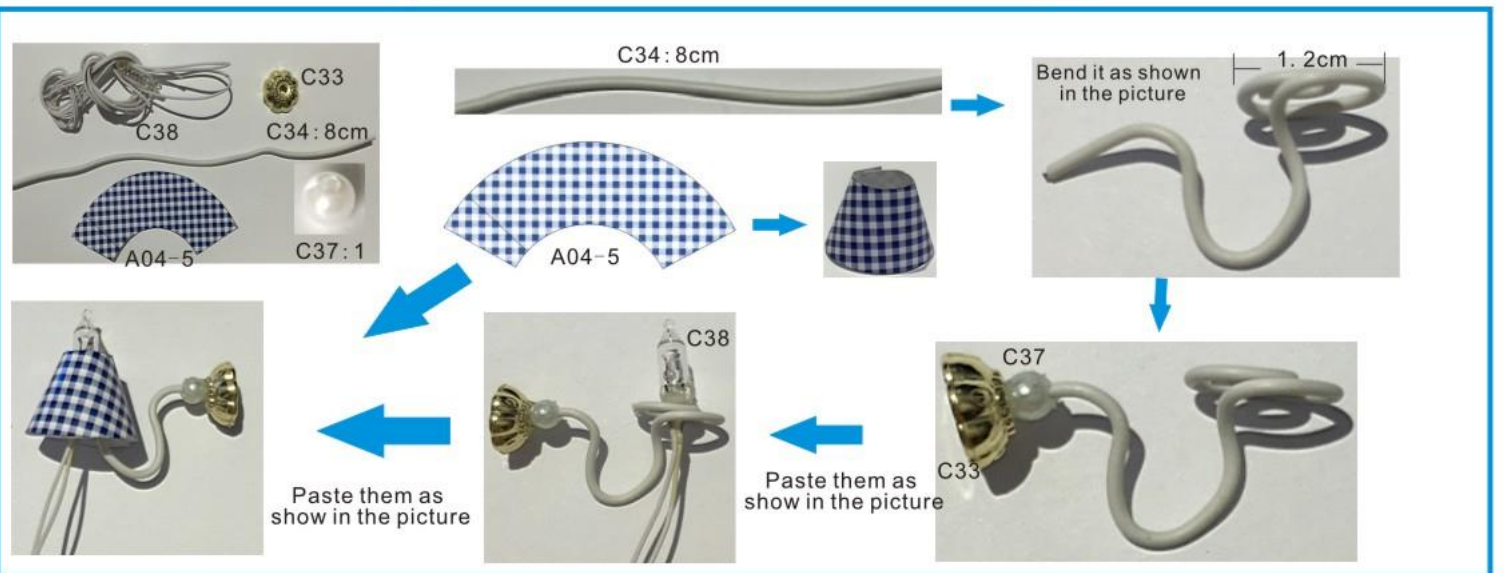
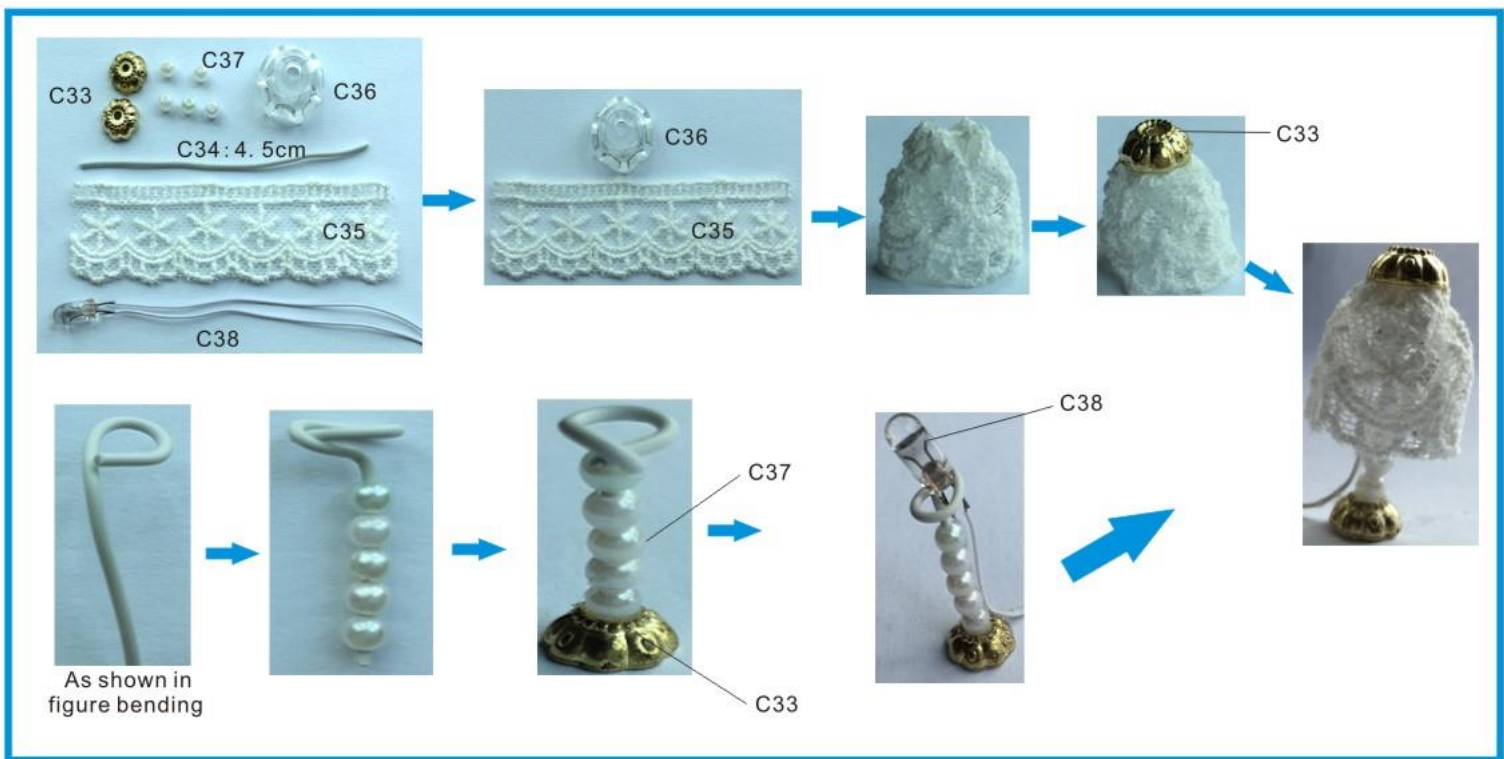
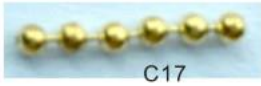
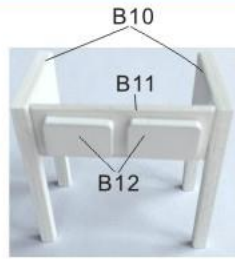
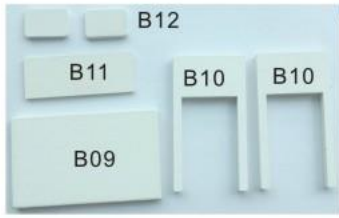

Table Lamp



Desk

6



Cut them as shown in the picture

Paste them in place

Chair

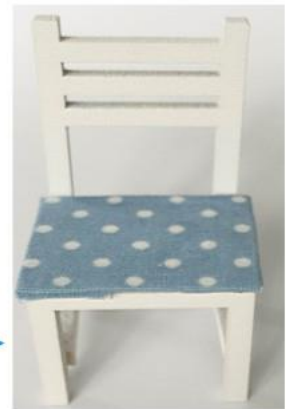

Cut out a piece of C08 according to the shape and size of B14.



Pack C08 with C05

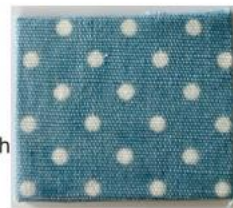

Paste them as shown in the picture

Handbag

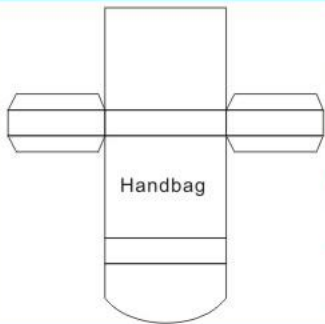

C17: 6cm)

Cut out a piece of C06 according to the handbag pattern.



Shelf



Paste them together

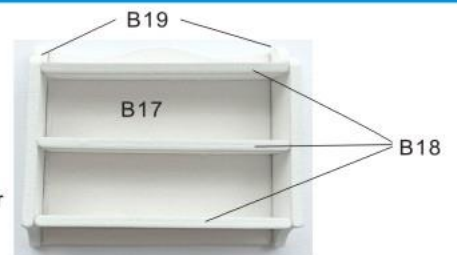

										A04-6-1										A04-6-9
										A04-6-2										A04-6-10
										A04-6-3										A04-6-11
										A04-6-4										A04-6-12
										A04-6-5										A04-6-13
										A04-6-6										A04-6-14
										A04-6-7										A04-6-15
										A04-6-8										A04-6-16
																				A04-6-17
																				A04-6-18
																				A04-6-19



Make all the books as above steps.



Wall painting/Illustration/Photo Frame

Wall painting/Illustration

A04-7-1 A04-7-2 A04-7-3

A04-7-4 A04-7-5 A04-7-6

C08

Cut out C08 according to the pattern of A04-7-1, A04-7-2, A04-7-3.

Cut out C08 according to the pattern of A04-7-4, A04-7-5, A04-7-6.

Paste them

Photo Frame

A04-7-7

A04-7-8

C08

Cut out C08 According to the pattern of A04-7-7, A04-7-8, and the holder of Photo frame.

Fold the Holder and paste it

Paste them separately.

Storage Box

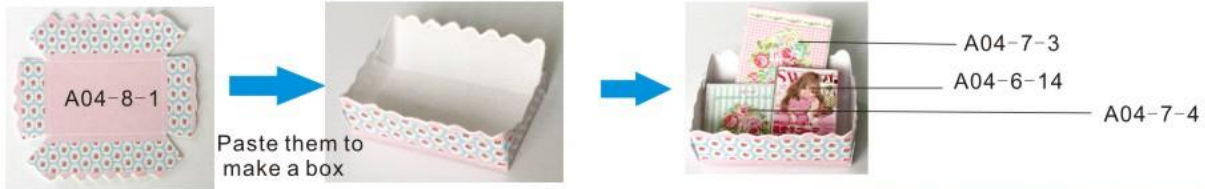

Doll

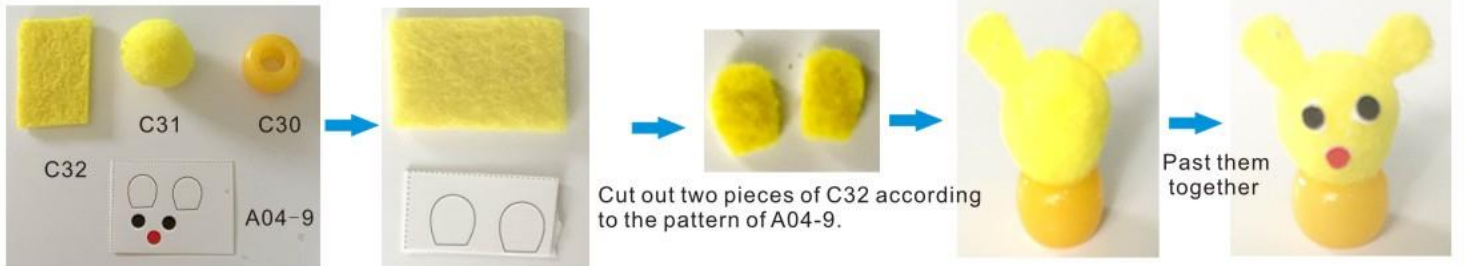

Potting



Notes: A04-10 is in the last part of the manual

Decorations on the Window

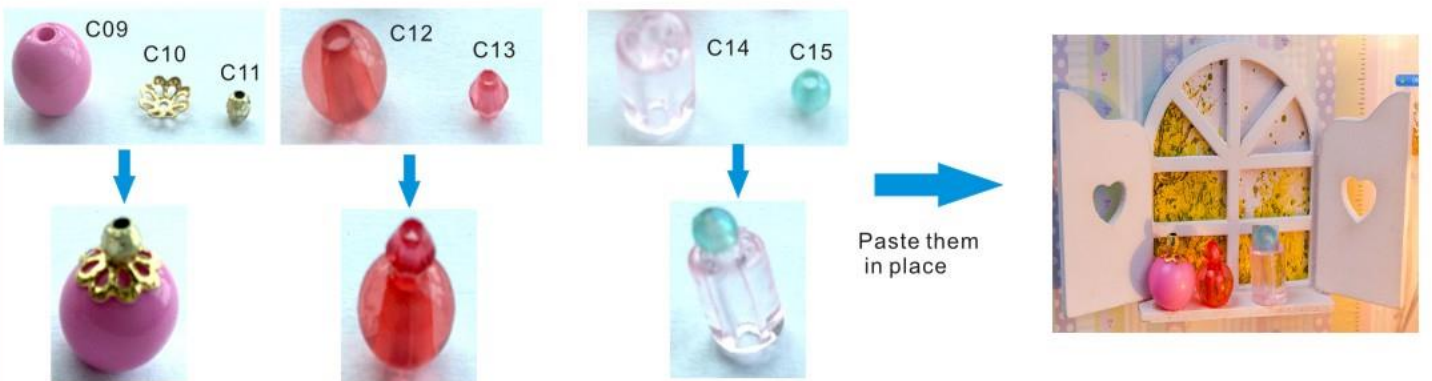

Decorations

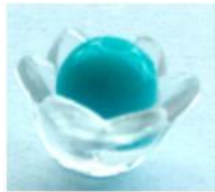
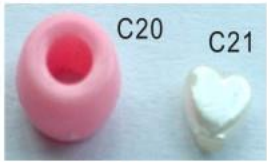

Books from A04-6-3 to A04-6-8

A04-7-1

A04-7-2

A04-6-2

Books from A04-6-9 to A04-6-13

A04-6-1



Desk and Decorations on Beside



Pillow



This is the picture after the pillow is turned outside in and sewed.

(Double up C02, sew it along the dotted Line.) (Turn outside in and fill it with cotton)

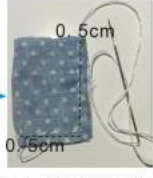
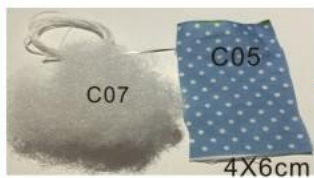

Double up C05 and sew it along the dotted line.



Paste C04 to the pillow

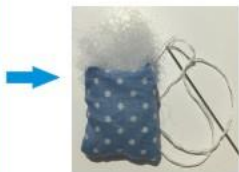
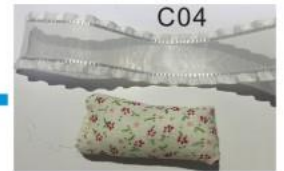

Turn outside in and fill it with cotton.



Follow the same steps to make two pillows.



Cut out two pieces of C06 (4*6cm and 5*9cm) to make two pink pillows by the same steps.



Put them in place



Paste the power wires of wall lamp and table lamp on the wall and ground.

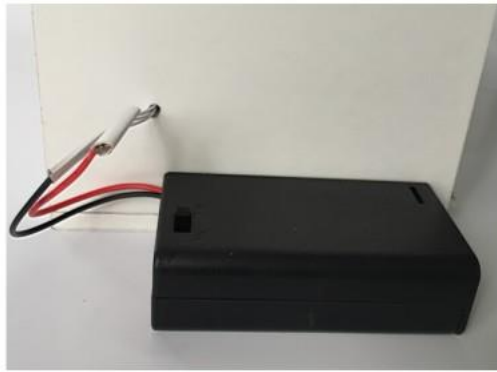

Note: Peel off the skin at the end of each bulb wire, separately twist VCC and ground wire together, connect them to the two wires of battery box, and seal the connector with gummed paper.

The connection of battery box and power supply

Warnings:

- Do not connect positive and negative terminals reversely.
- Do not put the battery in the fire.
- Do not damage outer package.
- The storage temperature should be 0~40 Celsius degree.
- Prevent it from contacting a metal or short circuit.
- Please install it strictly according to user manual.



1. Firstly connect power wires and then install batteries correctly. Peel off the skin at the end of each power wire and connect them to the battery box as shown in the diagram.

Dustproof Cover



D01 organic glass (transparent)
0.15*10.5*14.6 (1 piece)



D02 organic glass (transparent)
C 0.15*11.7*14.1 (1 piece)



D03 organic glass (transparent)
0.15*9.85*11.7 (1 piece)

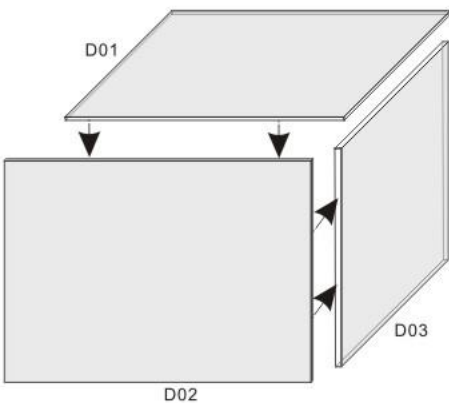

Paste the dustproof cover as shown in the picture.

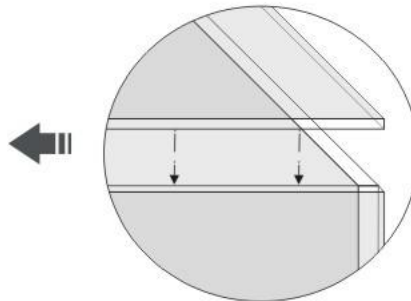

2. Tear off the kraft paper from each piece of glass and then paste them together.



A04-10

