

青涩回忆

Youth Ever

Belong to the summer sun and young chirping girl who wears white shirt.
Youth is the most beautiful thing which is sweet and bitter.



D014 User Manual

Notes: The product has a dustproof cover which is composed of three pieces of organic glass.
Timber, cloth and bead might be slightly different between batches, please refer to the real product for detailed information.

Lateral View



Warm Prompt

1

⚠ Cautions :

Please do not allow infants and young children to play with the package for avoiding dangerous accidents!
The product must be taken out by adults and then played by children.
Children must be under the custody of adults when playing with the product

Necessary Tools

(Tools are not included in the packing list and should be prepared by users)



Tips for assembling

- ① Please read the user manual carefully before assembling.
- ② Firstly polish corners of wooden materials by sandpaper, and then assemble every part tidily according to Part Number.
- ③ Use tweezers to help pasting tiny materials.
- ④ Use pliers to shape iron wire.
- ⑤ Dotted lines on paper accessories are folding line, and grey parts are for pasting.
- ⑥ It is suggested to paste paper accessories by double faced adhesive tape.



Material Bag A

(Unit: cm)

2

						A07 printed paper (at the end of the manual)	A08 glue (1 piece)
--	--	--	--	--	--	---	-----------------------

Material Bag B

(Unit: cm)

Material Bag C

(Unit: cm)

3

Instructions for Making Outer Frame

4

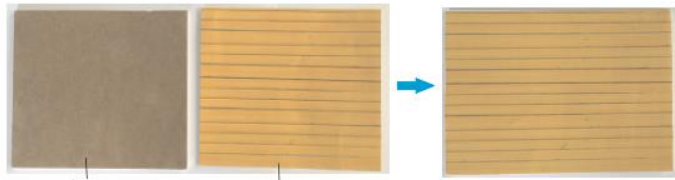

1. Take out the materials and paste the printed paper to the board.

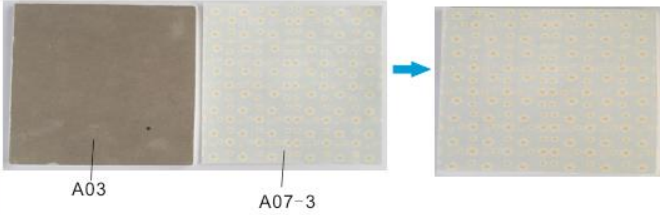

5. Take out the materials and paste the printed paper to the board.

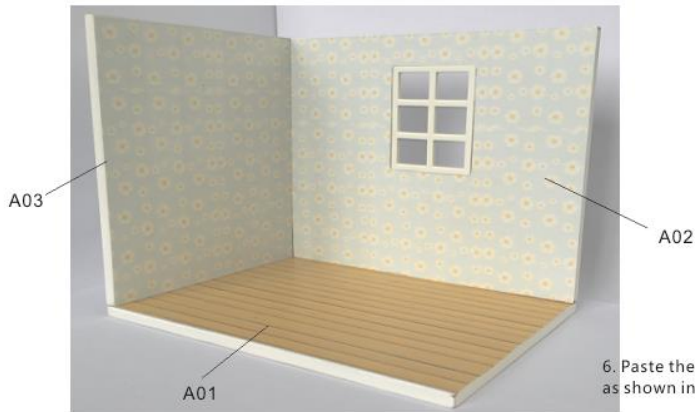

6. Paste the boards together as shown in the picture.

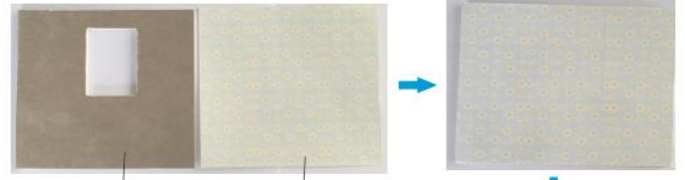

2. Take out the materials and paste the printed paper to the board.

3. After the glue is dried, cut out a hole for window with a small knife.

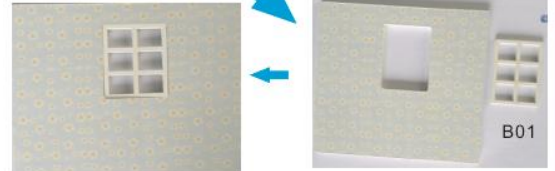
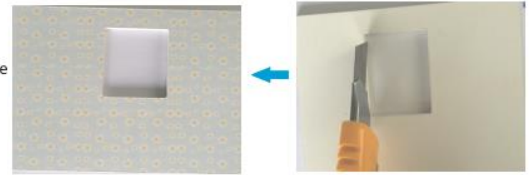

4. Take out B01 and paste it to make a window

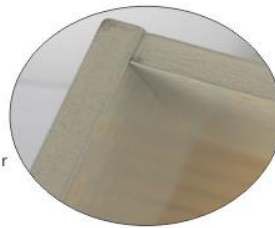

Instructions for Making Curtain

5



1. Take out the materials and paste them as shown in the pictures.

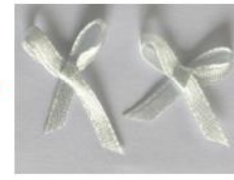
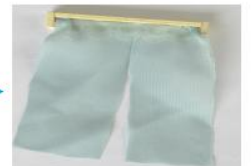
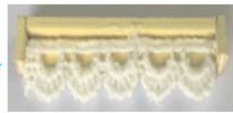
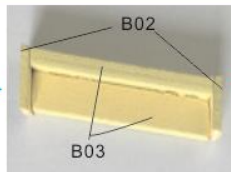

2. Cut out two pieces of C03 (5cm each) to tie up C02. Cut out another two pieces of C03 (10 cm each) to make two bowknots and paste them as shown in the picture.

Instructions for Making Bunk Bed

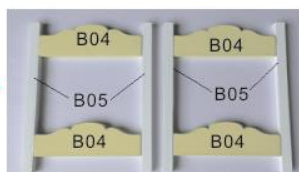

Paste the materials together to make a frame of the bed.



Paste two pieces of C05 to each paper board.

Paste C06 as shown in the picture to make two mattresses.

Instructions for Making Bed Sheet and Pillow

C07
C07 : 8x11cm(2 pieces)
Cut out two pieces of C07 (8x11cm each), fold one of them in half, sew it along the dotted line from the reverse side and then turn outside in.

Put the opening inside and sew it completely.

Follow the same steps to make another bed sheet

C12 (Please provide needle and thread for yourself!)
C08 : 3.5x6cm
C08 : 3.5x6cm
C09 : 7cm
Fold it in half, and this is the reverse side of C08.

Sew it along the dotted line and then turn outside in

This is the picture after turning outside in

Fill it with wadding, put the opening inside (about 0.5cm) and sew it completely

C09 : 7cm(4 pieces)
Cut out four pieces of C09 (7cm each) and paste them as shown in the picture to make two yellow pillows.

C12 (Please provide needle and thread for yourself!)
C10 : 3.5x6cm (2 pieces)
Follow the same steps to make two striped pillows.

C11 (Please provide needle and thread for yourself!)
C08 : 4x6cm
C12
Fold it in half, and this is the reverse side of C08

Follow the same steps to make a long pillow.

Wrap the long pillow with C11 to complete the pillow.

Instructions for Making Cabinet and Decorations

Cabinet
B10 B10 B12
B11 B11 B11
B10 B11 B11
B10 B11 B11
B12 B12
B10
B13 B13 B16 B16
B14 B14 B17 B17
B15 B18
B14 B17
B13 B16
Big cabinet
2 small cabinets

Photo Frame
A07-4-1 A07-4-2
C04
Paste A07-4-1 and A07-4-2 to C04 and cut it out.
Cut out C04 as per the pattern.

Gift Box
A07-5
Paste it as shown in the picture.

Books
A07-6-1
Fold it up as shown in the picture
Make 7 books with A07-6-1 to A07-6-7

Roses
Cut out the pink and green paper in the last part of this manual.
Roll up a small petal to make a stamen.
Paste two petals.
Paste four petals
4 leaves.
2 leaves.
Cut out three pieces of C22 with the length of 3.5cm, 3.2cm and 2.5cm.
Follow the above steps to make three roses.

C31

Desk

Perfume Bottle

Paste them together as shown in the picture.

Table Lamp

Paste C09 as shown in the picture.

Bend it as shown in the picture.

Peel off a part of the skin from C18 to expose the silver iron wire.

Paste it as shown in the picture.

Make a bowknot with C14. Paste it as shown in the picture.

Desk Calendar

Paste it as shown in the picture.

Cut out five pieces of A07-8-1, paste three pieces to the front side and two pieces to the back side.

Fold it up and paste it as shown in the picture.

Packaged Books

Paste them as shown in the picture.

Embed it in the frame.

Chair

Handbag 1

Cut out a piece of C17 as per the pattern of A07-11.

Handbag 2

Cut out a piece of C10 as per the pattern of A07-12.

Books

Handbag 3

Cut out a piece of C10 as per the pattern of A07-12.

Paste it as shown in the picture.

Handbag 4

Paste it as shown in the picture.

The reverse side

The reverse side

The reverse side

The reverse side

Cut C15 in half, paste them to the bag and finally put A07-14 into the bag.

Table

Small Fruit Basket

IPAD

Cut out a piece of C21 (4cm) and bend it as shown in the picture.

Cut out a piece of C21 (5cm) and bend it as shown in the picture.

Paintings

Cut out C04 as per the patterns.

Books

Fold and paste them as shown in the picture to make books.



As shown in the picture, paste table lamp and wall lamp in place and fix power supply wires on the wall.

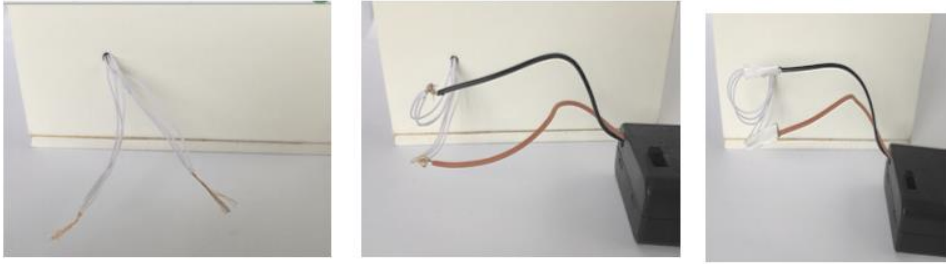

The connection of battery box and power supply
Cautions:
 Do not connect positive and negative terminals reversely.
 Do not put the battery in the fire.
 Do not damage outer package.
 The storage temperature should be 0~40 Celsius degree.
 Prevent it from contacting a metal or short circuit.
 Please install it strictly according to user manual.

Peel off the skin from the end of each bulb wire, twist the power wires and ground wires separately and connect them to the two wires of battery box as shown in the picture and wrap the connector with gummed paper.



Notes: It's forbidden to touch the copper wires of power wires when power supply is connected. Please do not turn on the battery box until the copper wires are properly wrapped with gummed paper.



Cut out C04 as per the patterns of A07-17, 18, 19, 20, 21, 22

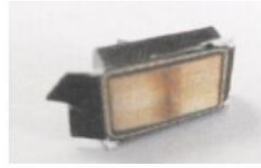
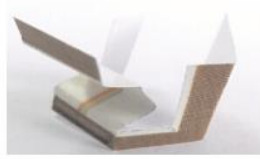
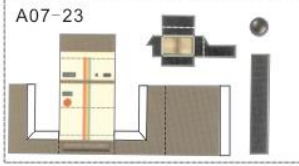

Camera

Cut out A07-23 as per the pattern, fold up the model and paste them as shown in the picture.

Instructions for Making Dustproof Cover

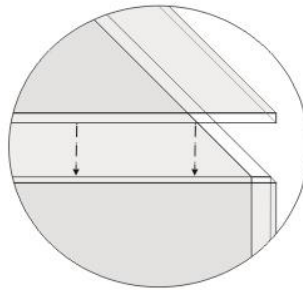
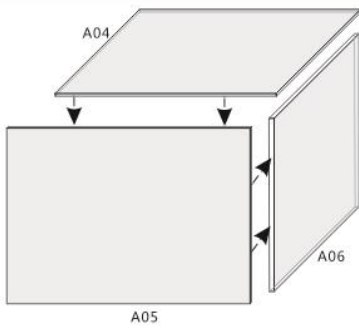

Paste the dustproof cover as shown in the picture.

Tear off the kraft paper from each piece of glass and then paste them.

Instructions on Making a Bowknot

Partial Pictures



1. Make a knot at the ends of the ribbon.



5. Fasten it up.



2. Press the middle position, and bend the right ribbon into a circle.

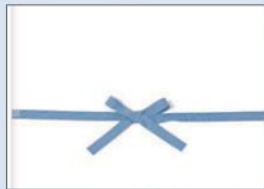

6. Trim both ends of the ribbons into expected shape to finish the bowknot.



3. Fold up the left ribbon and press it with right thumb.



4. Get left ribbon to pass over right ribbon and go through the circle formed by left ribbon.



A07-26

C37

C09

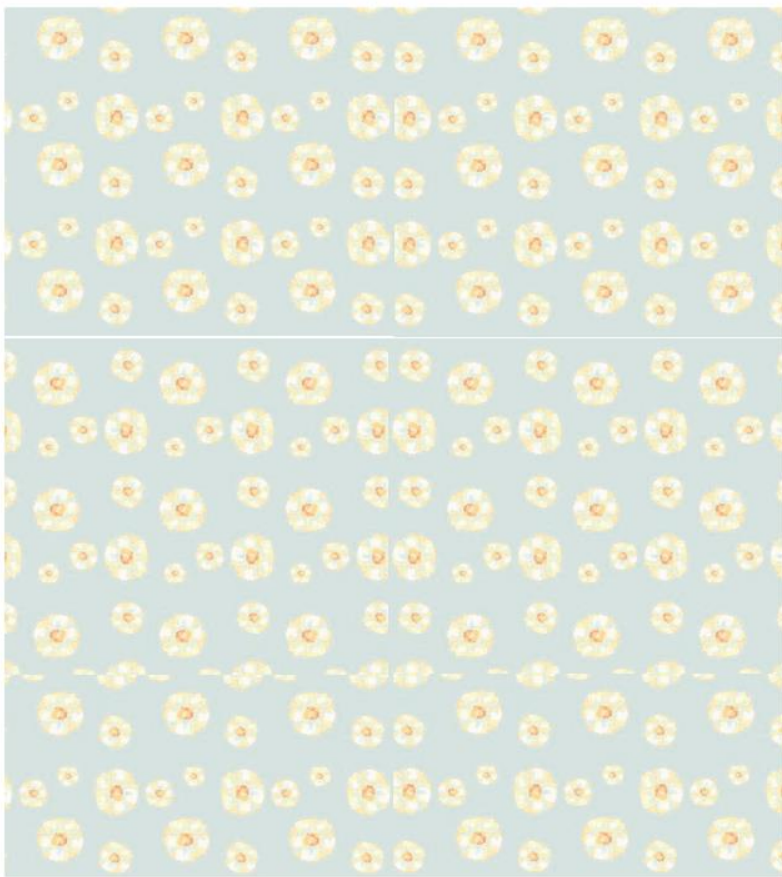

A07-3

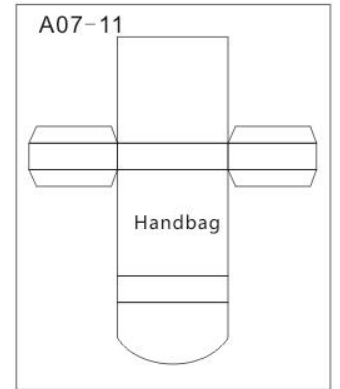
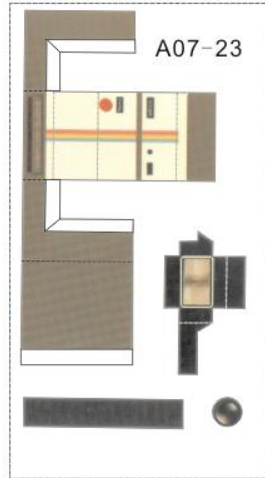
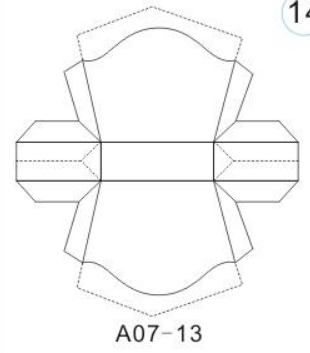
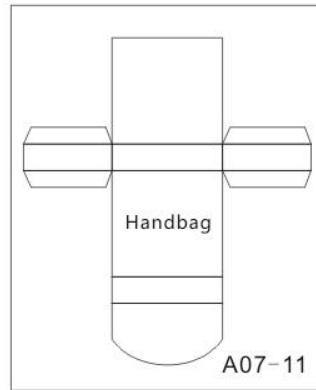

A07-25

D014 (5-1)

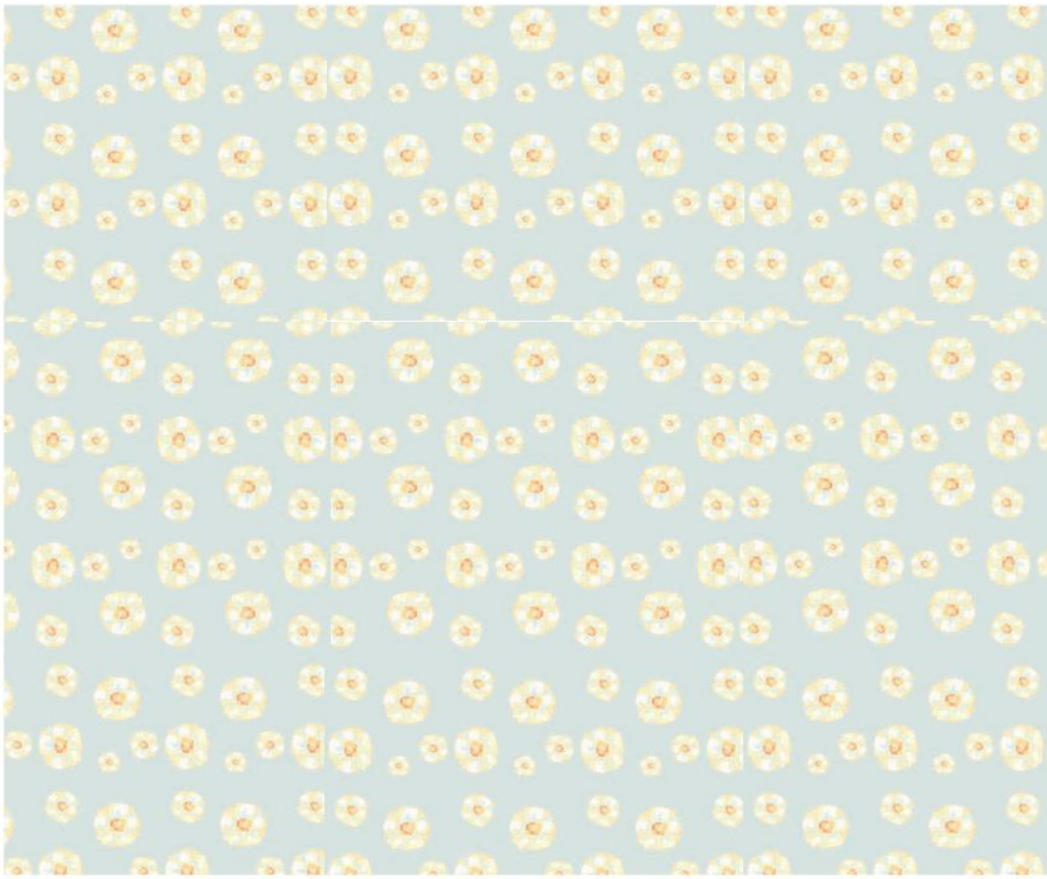

A07-2



A07-10

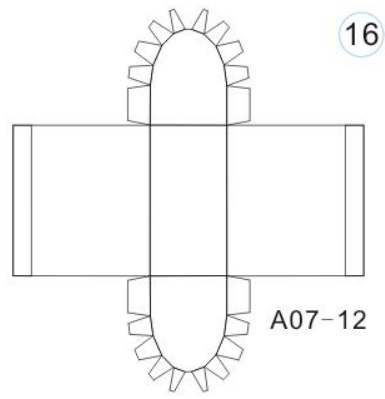

A07-12



A07-9-2

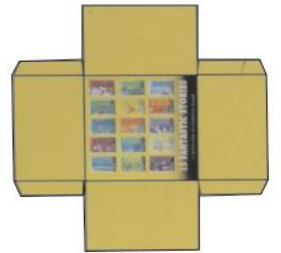

A07-9-1

D014 (5-2)

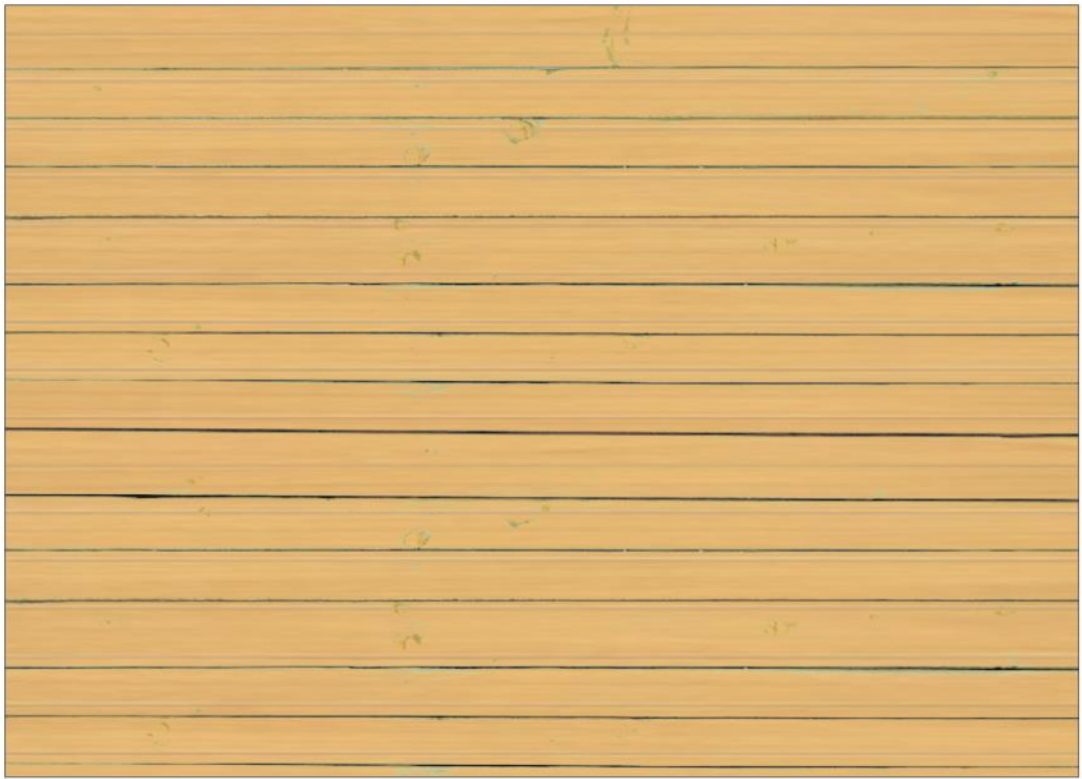

A07-8-2



A07-8-1

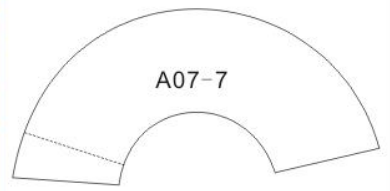

A07-7

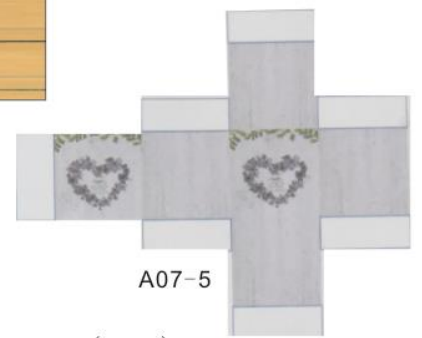

A07-5

D014 (5-3)

A07-1



A07-24

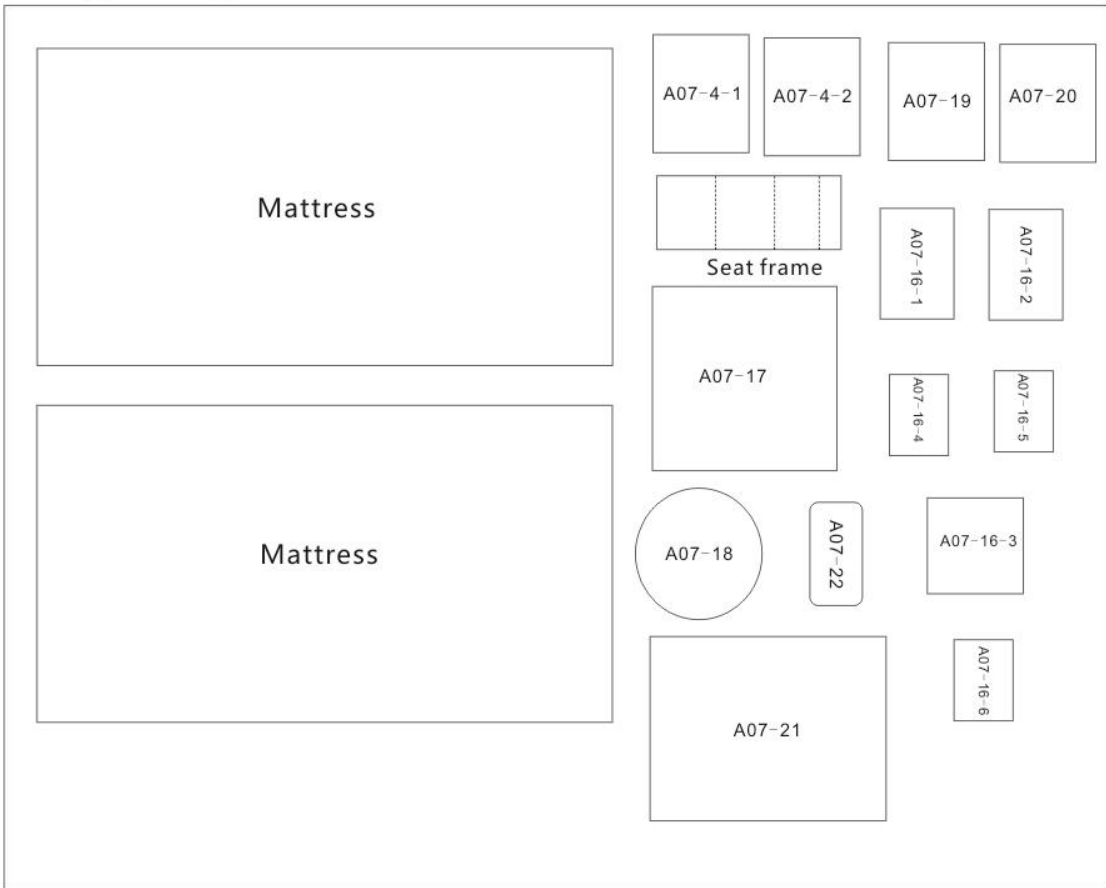

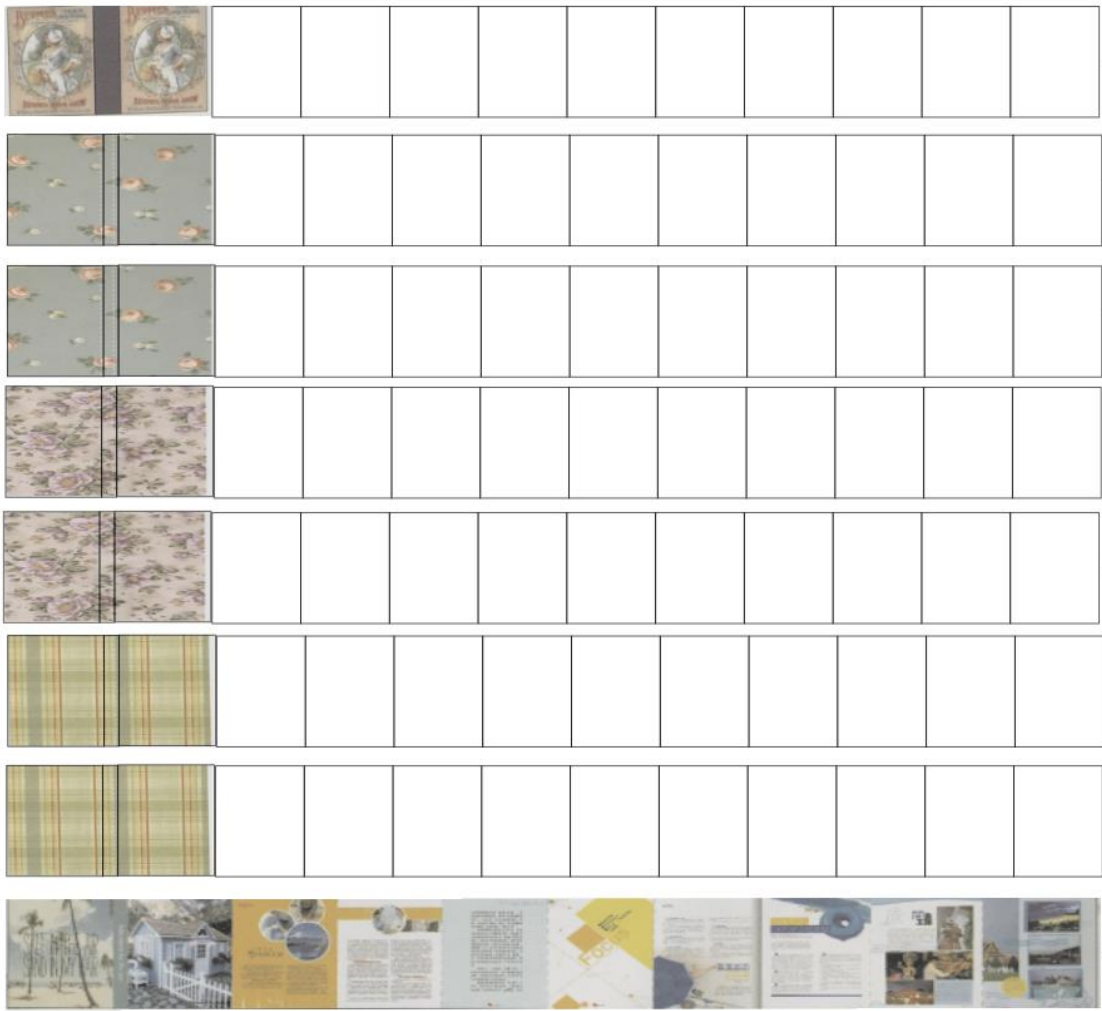

A07-6-1
 A07-6-2
 A07-6-3
 A07-6-4
 A07-6-5
 A07-6-6
 A07-6-7
 A07-14-2

