

User Manual

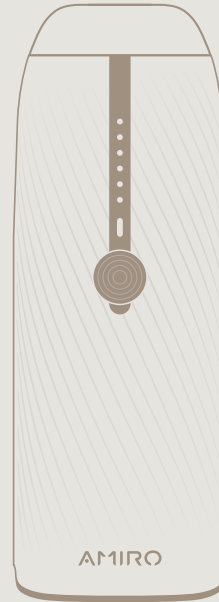

Shenzhen Fansizhe Science And Technology Co., Ltd.

2nd、3rd and 4th floors, No.11, Henggangxia Industrial Zone, Xiangshan Community,
Xinqiao Street, Bao'an District , Shenzhen, Guangdong, China. (Zip code 518125)
Contact phone: +86-755- 85275266 Email: 119909952@qq.com

Device Name: Intense Pulsed Light (IPL) System
Model: T033KW

Version: V1.0 Date: Apr. 10, 2023

Table of Content

1. Safety Instruction	02
2. Symbols.....	05
3. Device Description.....	06
3.1. General introduction	07
3.2. Indications for use	07
3.3. Introduction of device	07
3.3.1. Device picture.....	07
3.3.2. Configuration of Main unit.....	08
4. How to Use.....	09
4.1. Device Operation Introduction.....	09
4.2. Skin Test Patch.....	13
4.3. Using Suggestions.....	14
4.4. Using Steps.....	16
5. Rare Side Effects.....	18
6. Cleaning & Maintenance.....	19
6.1. Cleaning.....	19
6.2. Maintenance.....	20
7. Storage.....	20
8. Recycling.....	20
9. Warranty&Support.....	20
10. Packing List.....	23
11. Specification Parameters.....	23
12. Frequently Asked Questions.....	25
13. Important Information Regardin Electro Magnetic Compatibility (EMC).....	27
14. Operatin record.....	34

1. Safety Instructions

Before using the Intense Pulsed Light (IPL) System for the first time, please read the user manual carefully.

Warning

- This device is not a toy, keep out of reach of children.
- Please verify the device before you start using it. **DO NOT** use if there is any damage.
- Keep the device and power adapter dry.
- Make sure the device operating voltage complies with the rated voltage of the power source.

Caution

The Intense Pulsed Light (IPL) System is an electrical device. As such, it should be used with special attention to safety. Please read all warnings and cautions before use, and strictly follow them when using the device.

Contraindications:

- The following persons should not use this device:
 - Pregnant women or while nursing, or during menstruation; children.
 - Your skin is sensitive to light and is prone to develop a rash or allergic reaction.
 - You have skin type V and VI (You rarely to never sunburn, very dark tanning). In this case you run a high risk of developing skin reactions, such as hyperpigmentation and hypopigmentation, strong redness or burns.
 - Persons with a history of skin diseases, Or those are currently being treated for skin related diseases.
 - Persons with precancerous lesions or multiple atypical birthmarks (moles) on the areas you want to use the device.
 - If the area you want to treat has infections, burns, eczema, hair follicle inflammation, scratches, open wounds, herpes simplex, lacerations or hematomas.
 - Persons with a history of collagen disorder, keloid scar formation or Difficulty in healing wounds.
 - Persons with a history of vascular diseases, such as varicose veins, etc.
 - Persons with diabetes, lupus erythematosus, porphyria, congestive heart

- disease, and bleeding disorders.
- Persons who have a history of immunosuppressive disease (including HIV infection and AIDS).
- If you are receiving or have received in the last couple of months radiotherapy or chemotherapy.

Warning

- **DO NOT** use this device on the following areas:
 - On areas with hyperpigmentation or hypopigmentation, intense redness, or burns.
 - On areas where you had surgery.
 - Around the eyes and eyebrows to avoid eye injury.
 - On the nipples, areolas, labia minora, vagina, anus, inside the nostril and ears. Menn cannot use this device on the scrotum and face.
 - Near silicone implants, pacemakers, subcutaneous injection port (such as insulin dispensers), body piercings. Any artificial surface should be avoided.
 - On moles, freckles, large veins, darker pigmented areas, scars, and skin abnormalities without doctor supervision.
 - On tattoos or permanent makeup, as it can cause burns to the skin and change its pigmentation.
 - On areas where you use long-lasting deodorants, as it may cause skin irritation.
 - Do not use this device on skin with sunburns, recently tanned or false tanned.
- **DO NOT** use this device if you take the following medications or treatments:
 - Your skin is being treated or has recently been treated with alpha-hydroxy acids (AHAs), beta -hydroxide acids (BHAs), topical isotretinoin and azelaic acid.
 - If you have taken oral or topical Accutane or Roaccutane acid in the past six months. This treatment makes skin more susceptible to lacerations, trauma, and irritation.
 - If you are taking any kind of photosensitizing agent or medication, always verify the patient information leaflet of the medicine, and do not use the device if it is specified that it can cause light allergy reactions, photo -toxic reactions, or if you should avoid sun exposure while taking the medicine.
 - If you are taking anticoagulant medicines, including the use of large quantities of aspirin and cannot stop at least one week before each treatment.
- Immediately **STOP** using the device and consult a doctor if you feel any discomfort.
- Do not leave the equipment unattended when it is switched on to avoid the risk of fire or burns.











- This equipment is not intended for use by persons with reduced physical, sensory or mental capabilities, or lack of experience and knowledge, unless they have been given supervision or instruction concerning use of the equipment to avoid the risk of fire or burns.
- This equipment is not intended for use by children. Keep it away from children. This is not a toy, the charging cord could lead to strangulation.
- Water and electricity are a dangerous combination! To avoid risk of electrocution.
 - do not use this equipment in wet surroundings (e.g. in the bathroom or near a shower or swimming pool);
 - do not let water run into the appliance.
- Check if the voltage indicated on the equipment corresponds to the local mains voltage before you connect the equipment to avoid risk of electrocution or permanent damage to the equipment.
- If the wall socket used to power the equipment has poor connections, the plug of the equipment becomes hot. Make sure you plug the equipment into a properly installed wall socket to avoid the risk of fire and burns.
- The PATIENT is an intended OPERATOR.
- Do not service and maintain while the device is in use.
- Do not locate the device so that it is difficult to operate the disconnection device.
- Preventive inspection, maintenance shall be performed Periodically to ensure the continued Safety of the device.
- At least 10 minutes is required for the device to warm from the minimum storage temperature between uses until the device is ready for its intended use when the ambient temperature is 20°C.
- At least 10 minutes is required for the device to cool from the maximum storage temperature between uses until the device is ready for its intended use when the ambient temperature is 20°C.











Caution

- **DO NOT** touch the internal parts to avoid electric shock, if the device is damaged,
- **DO NOT** insert any objects into the device.
- The adapter contains a transformer, **DO NOT** cut the power converter to replace it with another plug as it is dangerous.
- **DO NOT** use the device if the filter of the light exit window is damaged.
- Regularly clean the device surface to extend its lifetime.
- **DO NOT** attempt to disassemble, repair or modify the device by yourself to avoid accidents.
- **DO NOT** use this device In an environment with flammable materials/ solutions/ gases or Or an oxygen-rich environment to avoid fire risk.

- When using this device, ensure you (and other people in the same room) do not look directly into the light exit window to avoid eye discomfort. **ALWAYS** use protective goggles (included) when using the device.
 - **DO NOT** cover the vent during use.
 - **DO NOT** wrap the cable around neck.
 - **DO NOT** use power adapter other than provided by the manufacturer.
 - This device is for single patient reuse.
 - **DO NOT** use the device after Sunbath.
 - Please do a cutaneous sensibility test and wait for 24 hours, if you are not sure whether your skin has been tanned or burned.
 - Please unplug the adapter after use.
 - The warning list is not exhaustive. If you are not sure whether you can or cannot use this device, please consult a doctor.
 - Do not subject the equipment to heavy shocks to avoid risk of damage to the lamp.
 - Always unplug the appliance after use and in case of a power failure to avoid risk of damage to the equipment.
 - Lint, dust, light (including sunlight) can effect your device, please avoid use or storage your product in such situation.
 - Please ensure your product can not be reached by pets, children.

2. Symbols

	Alternating current		This way up
	Direct current		Date of manufacture
	CLASS II equipment		Temperature limit
	Caution		Humidity limitation
	Warning		Atmospheric pressure limitation

	Type BF applied part		The device should be sent to the special agencies according to local regulations for separate collection after its useful life
	Refer to instruction manual		This device has not been tested for use in an MR environment and should not be used exposed to MR environments while patients are wearing the device. Keep it outside the MRI scanner room.
	Manufacturer		Wear eye protection
	Serial number		Indicates a medical device that can be broken or damaged if not handled carefully.
	Indicates a medical device that needs protection from light sources.		Indicates a medical device that needs to be protected from moisture.
	Federal Communications Commission		

3. Device Description

Intense Pulsed Light (IPL) System is a device for hair removal based on Intense Pulsed Light (IPL). It works below the skin's surface. The device is only powered by the external power adapter and its IPL emission activation is by finger switch, the purpose of the IPL light is to heat the root where the hair grows. The device incorporates Intense Pulse Light (IPL) technology.

The Intense Pulsed Light (IPL) System features cooling care function which realized though semiconductor cooling plate, this function auto starts when device is powered on and auto off when device is powered off. The cold side of semiconductor cooling plate contacts Sapphire Cooling Plate which is the surface of Light Exit Window and contact with skin surface directly. Since the temperature of Sapphire Cooling Plate lower than temperature of skin surface, it generates cooling feeling when device contacts with skin surface during it works, this is a physical heat transfer process.

The device is intended to be used for adults aged over 18.

3.1. General introduction

Device Name: Intense Pulsed Light (IPL) System
Model: T033KW

3.2. Indications for use

The Intense Pulsed Light (IPL) System is an over-the-counter device intended for the removal of unwanted body hair.

3.3. Introduction of device

3.3.1. Device picture

Main unit (picture 1):

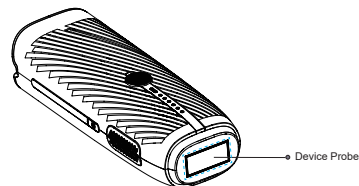

Main unit (picture 2):

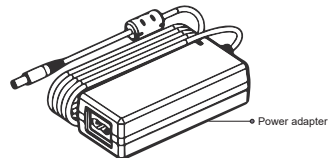

Main unit (picture 3):



3.3.2. Device picture

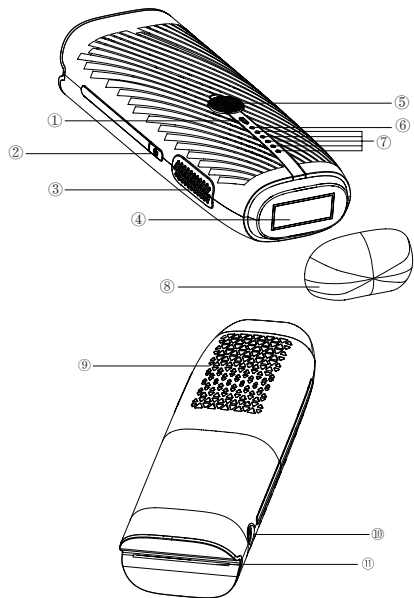

① Flash Ready Light

② On/Off / Level adjustment button

③ Air vent

④ Light Exit Window (3.3cm²) / Sapphire
Crystal Cooling Compress

⑤ Flash Button

⑥ Mode indicator

⑦ Intensity level

⑧ Protect cover

⑨ Air vent

⑩ DC Plug-in Port

⑪ Air vent

Status of Flash	When	Graphical representation
Ready Light		
Light on	1. In "Manual Emit Flash mode", the Device probe is not in full contact with the skin.	
Light with blinking	1. In "Manual Emit Flash mode", the Device probe fully contact the skin and device is ready to trigger a flash, but you haven't pressed the Flash Button yet. 2. In "Auto Emit Flash mode", the Device probe is not in full contact with the skin.	

4. How to use

To ensure the correct operation of this device, please read the instructions carefully before use.

4.1. Device Operation Introduction

- **Preparation:** Connect power adaptor and main unit like following picture 4:

Picture 4:

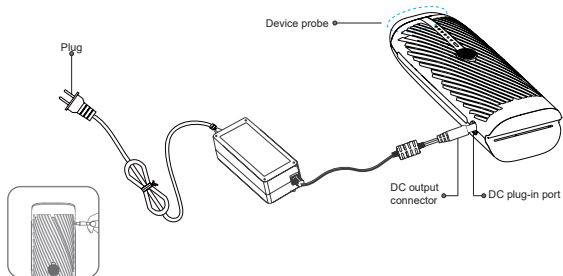

Insert the plug into a power socket and the device gets in standby.

Powered on: With the device in standby, press and hold the "On/Off/Level adjustment button" for about 2 seconds, the device will be powered on at the first intensity level setting with a one beeping sounds, at the same time the Fan and cooling care function begin working. (Picture 5)

Picture 5:

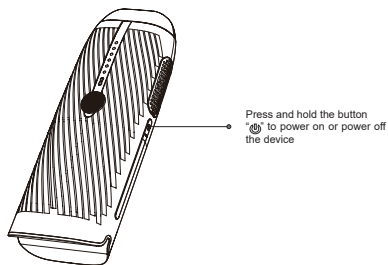

- **Powered OFF:** Press and hold the "On/Off/Level adjustment button" for about 2 seconds, mode indicator, the Intensity Level Lights and the Flash Ready Light will go out, and the device powered off after one beeping sound, and only fan continues working for another 15 seconds after device powered off.
- **Intensity Level Adjustment:** With the device Powered on, press the "On/Off / Level adjustment button" to adjust the treatment intensity level in a cycle-a total of 5 levels. First-time users should start the first session at the lowest intensity level. You can gradually increase the intensity level. (Picture 6)

Picture 6

Level 1	Level 2	Level 3	Level 4	Level 5
•	•	•	•	•
•	•	•	•	•
•	•	•	•	•
•	•	•	•	•
•	•	•	•	•

• **Manual Emit Flash mode:**

- (1). With the device Powered on, the device automatically enters "Manual Emit Flash mode" and "double pulse exposure mode".
- (2). Put the Device probe against the area to be treated and press (Picture 7)

Picture 7

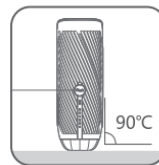

- (3). When Flash Ready Light is light with blinking, press the Flash Button to trigger a flash. (Picture 8)

Picture 8

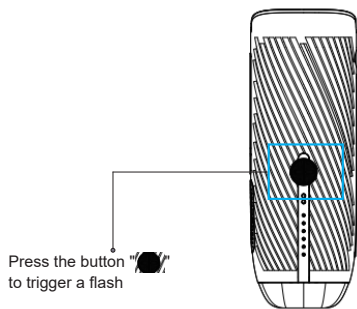

Notes: 1). In "Manual Emit Flash mode", if the Device probe is not in full contact with the skin, the Flash Ready Light will light on and the device does not emit the flash when pressing the Flash Button.

2). In "Manual Emit Flash mode", if the Device probe fully contact with the skin but not press the Flash Button to trigger a flash, the Flash Ready Light will light with blinking.

3). If the Light Exit Window is close to the skin and does not move, and the flash is continuously exposed for 8 second, Flash Ready Light will be light without blinking and device stop emitting flash.

4). "Manual Emit Flash mode" is recommended for small area hair removal;

• **Auto Emit Flash mode:** With the device in "Manual Emit Flash mode", press and hold the Flash Button for about 2 seconds, the device is into "Auto Emit Flash mode" with two short beeping sounds and Flash Ready Light lights with blinking, press the Device probe against the area to be treated, the device will emit the flash automatically without pressing the Flash Button.

• Notes: 1). In "Auto Emit Flash mode", if the Device probe is not in full contact with

the skin, the Flash Ready Light will light with blinking and the device does not emit the flash.

- 2). Once the Light Exit Window is close to the skin, the flash is continuously exposed for 8 seconds, the Flash Ready Light will be light with blinking and device stop emitting flash.
- 3). "Auto Emit Flash mode" is recommended for large area hair removal.
- 4). Ensure that the ENTIRE AREA receives treatment, but DO NOT overlap treatment pulses.

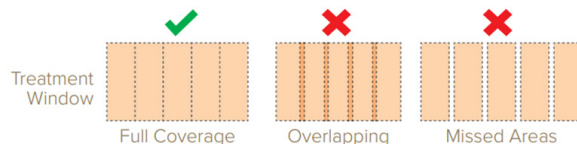

• **Mode switch:** During device working, take away device from the skin, press and hold the Flash Button for about 2 seconds, if there are two short beeping sounds and Flash Ready Light lights with blinking, the device is switched into "Auto Emit Flash mode", if there is one beeping sounds and Flash Ready Light lighting on, the device is switched into "Manual Emit Flash mode".

• Mode switching for single and double pulse light : press the exposure button + power on button at the same time for 2 seconds.

1) The exposure mode indicator does not light up to indicate a single-pulse exposure mode, one triggering one flash.

2) The exposure mode lights up shows double pulse exposure mode, one triggering two flashes.

4.2. Skin Test Patch

※For first-time users, we recommend you to test the device on the arm for reactions with following skin test patch:

a) Turn on the device, select the intensity level 1, press the Device probe on the skin and apply one flash.

b) Wait 24 hours and check your skin for any reaction such as discomfort or pain.

c) If the skin on the test site is normal (no discomfort or pain), you can continue to

use it, if it is abnormal, please stop using it.

d) Increase the intensity by one level, and slide the device to the next area (do not flash multiple times on the same area). Test each intensity level according to above steps a) to c).

Stop increasing the intensity level and stop the testing when the device causes any discomfort (or pain). **Example:** You can increase the intensity to level 2 and test it according to above steps a) to c) only when the device does not cause any discomfort (or pain) at level 1.

※After you test the skin, choose the intensity levels that did not cause a reaction on your skin.

※Wait for 24h each time after following the test patch to verify if your skin has an adverse reaction to the treatment. If there is no visible reaction, you can use the device.

4.3. Using Suggestions

※Before using the device you removed hairs by using a long-lasting removing method, such as plucking, waxing, etc., wait until hairs start growing again to use the device.

• Treatment areas

Suitable for the body parts: small areas such as underarm and facial hair below the chin line and large areas such as legs.

• Treatment time

According to hair growth cycle, it is recommended to use the IPL Hair Removal Device once every two weeks for the first 3-4 times and gradually reduce the use according to hairs condition.

• Skin tone/hair color reference chart

Please refer to the chart below before you start using the device to determine if your skin tone and hair color are suitable to use (“√” means the device is suitable for you; “X” means the device is not suitable for you).

Darker skin tones absorb more light easily causing skin irritation. Therefore, persons with darker skin tones are recommended to use a lower flash intensity light. For brown skin tone, please start from the lowest speed mode and adjust the speed setting according to your pain sensation.

SKIN Tone:

The product is suitable for the skin tone in Type I to Type IV. Please identify your skin tone and check the following table to see whether the product is applicable.

Skin tone table:

Skin type/color	View	Safety grade
Type I Pale white skin		Applicable
Type II White skin		Applicable
Type III Cream white skin		Applicable
Type IV Moderate brown skin		Applicable
Type V Dark brown skin		Not Applicable
Type VI Deeply pigmented dark brown to darkest brown, black skin		Not Applicable

HAIR COLOUR:

The IPL system is suitable for use on naturally black or brown hair. It may not be as effective on white, grey, blonde or red hair.



4.4. Using Steps

- Before you start using the device, use a razor or trimmer to shave all hairs on the surface of the skin (do not pluck or use chemical hair removal products) (figure 9), completely dry the skin and remove any oily substances (such as body fragrance, lotion, perfume, sunscreen, and other cosmetics).

Figure 9



- Connect power adaptor and main unit and then inserting the plug into a power socket.
- Press and hold the "On/Off/Level adjustment button" (power button icon) to turn on the device.
- Select the appropriate flash intensity for your skin tone and hair color (for first-time users, use the lowest light intensity recommended and adjust it gradually).
- Wear protective goggles to avoid looking into the light (figure 10).

Figure 10



- Press the Device probe on the skin, ensuring the Device probe is fully in contact with the skin (Figure 11). Wait for a few secs, when the Flash Ready Light lights with blinking, press the Flash Button to apply the flash. You will feel a slight burning sensation (flash light energy being absorbed). If you want to reduce the burning sensation, adjust the intensity level.

Figure 11

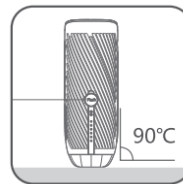

- After use, turn off the device, unplug the power adaptor, and clean the device.
 Note:1). This device features cooling care function, this function autostarts when device is powered on and auto off when device is powered off. The cold side of semiconductor cooling plate contacts with Sapphire Cooling Plate which is the surface of Light Exit Window and contact with skin surface directly. Since the temperature of Sapphire Cooling Plate lower than temperature of skin surface, it generates cooling feeling when device contacts with skin surface during it works, this is a physical heat transfer process.
 2). The device is equipped with fan in the main unit which is used to cool the internal parts of the main unit during device working. When device is powered on,

the fan begins working with a sound of the wind all the time until 15 seconds after device powered off.

3). Clean the device according to chapter 6 of this manual after unplug the power adapter 20 minutes.

4). After cleaning, put the device and adaptor back to the packing box and storage it according to specified storage condition.

Caution

1. After using the device, **DO NOT** apply any fragrant skin care or cosmetic product on your skin.
2. **DO NOT** use deodorant immediately after using the device on the armpits. Wait until the skin redness completely disappears to start using deodorant.
3. After each treatment, make sure your skin doesn't show any signs of redness after 24 hours.
4. Keep the treated area covered and away from direct sunlight two weeks after the treatment or use sunscreen (SPF30+) on the treated area.

5. Rare Side Effects

• Burns, abnormal redness and swelling

These reactions are very rare, they may be caused by using a high flash intensity. If these adverse reactions continue for 3 days or more, immediately consult a doctor. Only start the next treatment if the skin is clear of any problem, and make sure you use a lower flash intensity.

• Skin discoloration

Normal but very rare. When using the device, the skin may suffer from discoloration, this may happen because you are using a high-intensity flash. When the discoloration disappears, reduce the flash intensity during the next treatments. If the skin discoloration does not disappear after two weeks, please consult a doctor.

• Skin infections and inflammation

Very rare. If the device is used in existing wounds and cuts (might happen when shaving the area) it can cause mentioned side effects.

• Possible causes of excessive pain during and after the treatment

You used the device on an area that was not shaved before you start the treatment; the flash intensity is too high for your skin tone and hair color; you used the device in the same exact area more than once; you used the device in an open wound; the area you are treating has any sort of inflammation or infection; you are using the device in areas with tattoos or sunburns.

6. Cleaning & Maintenance

6.1. Cleaning

After each use, clean this device following below tips:

Purpose: This device is for reuse to remove unwanted hair; you may clean the device surface since which can be contaminated during use with organic soil and microorganisms carried by human hands immediately after each use.

Cleaning Agent: 70% isopropyl alcohol wipe.

Method of Cleaning: To thoroughly clean the device, immediately after each use, rubbing device (including markings) such as the Light Exit Window, shell and button by hands without undue pressure with 70% isopropyl alcohol wipes for 15s and Light Exit Window for 3s

Note:

- a) Ensure that no liquid enters the interior of the device
- b) NEVER use abrasive cleaning agents, thinners or benzene for cleaning.
- c) NEVER immerse the instrument in water or other cleaning liquids.
- d) Wait 10 minutes after cleaning, allowing the device to air-dry.

Visual Inspection: After cleaning, there should be no visible blotches and soil stains on the device under nature light, if there are still blotches and/or soil stains existed, repeat the cleaning steps mentioned above until there is no visible blotches and soil stains.

Disposing the device if there is corrosion, discoloration, pitting or cracked seals after cleaning, enquire about the options for environment-friendly and appropriate disposal. Take local regulations into account.

Reuse Life: 400,000 flashes

6.2. Maintenance

- The Light Exit Window is very delicate. It is very important to protect the Light Exit Window from dirt and damage. Do not touch or use tools press it. Must be carefully protected.
- This device is not waterproof. **DO NOT** immerse it or wash it under running water.
- **DO NOT** use steel wool, abrasive cleanser, chemicals or corrosive liquids to clean the device

7. Storage

DO NOT place or store the device for long periods in a hot or humid environment. Storage this device in following condition:

Storage environment	Temperature: -20 ~ 55°C Relative humidity: 5 ~ 95%, without condensation Atmospheric Pressure: 70 kPa ~ 106 kPa
---------------------	---

8. Recycling



At the end of its life, do not dispose of this device with the household waste. Please take this device to a local recycling point for proper. Proper disposal and recycling practices contribute to environmental protection.

9. Warranty&Support

• Troubleshooting

Problem	Possible Cause	Solution
Indication light is off	The power cable is not properly connected.	Check the connection of the power supply and adjust the cable.
	Only press "On/Off/Level adjustment button" but not hold it, fail to turn on the device	Press and hold the "On/Off/Level adjustment button" for about 2 seconds to turn on the device.

The device does not emit the flash	The power cable is not correctly connected.	Check the connection of the power supply and adjust the cable.
	The Device probe is not close enough to the skin.	Re-adjust the position of the Device Probe on your skin until the Flash Ready Light lights with blinking.
During use the device has enter standby mode.	The device power off automatically if no light is emitted within 3 minutes.	press and hold the "On/Off/Level adjustment button" for about 2 seconds to turn on the device.
The device produces an odd smell	The light exit window filter is dirty	Carefully clean the light exit window filter with 70% isopropyl alcohol wipe.
	Hairs were not properly removed before the treatment. The flash burns the hair causing an odd smell.	Before you start using the device, remove all hairs from the area you want to treat with a razor blade or trimmer.
You feel pain when using the device.	The flash intensity is too high.	Verify the flash intensity and reduce it
	The filter of the light exit window is damaged.	Please stop using the device and contact your Fansizhe local dealer for assistance.
	You are using the device in a non-applicable area.	Please read the instruction manual, warnings and prohibited use are mentioned.
After using the device, the treated area shows signs of redness.	Mild redness is a normal and harmless reaction to the hair removal.	Do not take any action, is a normal reaction.

The treatment results are not satisfactory.	The flash intensity used is too low.	Next treatment, adjust the flash intensity
	The frequency is lower than recommended.	In order to keep the skin smooth and without hairs, is recommended to use the device once every two weeks. Treatment intervals depend on each person hair growth cycle, do not use the device more than once every two weeks Overusing the device increases the risk of adverse skin reactions.
The treatment results are not satisfactory.	Your skin tone and hair color are not suitable to use with this device.	If your body hairs are blonde, red, gray white, or if your skin tone is very dark, do not use this device.
Other problems.		Contact your local dealer.
Note: If the device still does not work properly after using the above solutions, please stop using the device and contact your local dealer.		

• After-Sales Service

Please contact your affiliate dealer in your country if you need to learn about our products or if you need any information

- **Manufacturer:** Shenzhen Fansizhe Science And Technology Co., Ltd.
- **Address:** 2nd, 3rd and 4th floors, No.11, Henggangxia Industrial Zone, Xiangshan Community, Xinqiao Street, Bao'an District, Shenzhen, Guangdong, China. (Zip code 518125)
- **Contact phone:** +86-755- 85275266
- **Email:** 119909952@qq.com

The MANUFACTURER will make available on request circuit diagrams, component part lists, descriptions, calibration instructions, or other information that will assist SERVICE PERSONNEL to repair those parts of ME EQUIPMENT that are designated by the MANUFACTURER as repairable by SERVICE PERSONNEL.

10. Packing List

Main unit	1PC	Power adaptor	1PC
Instruction book	1PC	Safety goggles	1PC

11. Specification Parameters

Device Name	Intense Pulsed Light (IPL) System
Model	T033KW
Dimension	183x66x40mm
Risk group	Exempt Group
Irradiation area	Light outlet: 3.3cm ²
Adaptor Input	100-240 Va.c., 50/60Hz, 1.5 A
IPL main part input	24 Vd.c., 2.7 A
Wavelength	560 ~ 1200nm
Max. Fluence	single pulse exposure mode:4.9J/cm ² double pulse exposure mode:5.1J/cm ²
Pulse duration	Pulse duration: < 10ms Width of single pulse string:250ms
Output energy	single pulse exposure mode:0.106-16.3J double pulse exposure mode:0.241J-16.7J
Service life	400,000 flashes
Service life for power adaptor	10 years
Service life for goggles	3 years
Weight	309g

Operating environment	Temperature: 5 ~ 30°C Relative humidity: 20 ~ 90%, without condensation Atmospheric Pressure: 70 kPa ~ 106 kPa
Storage and transportation environment	Temperature: -20 ~ 55°C Relative humidity: 5 ~ 95%, without condensation Atmospheric Pressure: 70 kPa ~ 106 kPa
Warranty period	One year warranty for main unit
Applied part	Type BF
Software version	T033KW-V1.0
No Sterilize requirement	
Not category AP / APG equipment	
Mode of operation: continuous	

Adaptor Technical specifications:

Item	Parameters
Model of adaptor	GJ72WA-2400270W2
Manufacturer of adaptor	Shenzhen Guijin Technology Co., Ltd
Input Voltage	100Vac~240Vac
Input Frequency	50Hz/60Hz
Service life for power adaptor	10 years
Output voltage range	+22.8~+25.2Vdc
Output current range	0-2.7A
output power	≤64.8W
output over voltage	≤ 170% of output voltage
current-limiting protection	5.5-9.0A

12. Frequently Asked Questions

Q: The device power off automatically during use.

A: The device will power off automatically when the internal temperature of the device is too high, please restart device after 10 minutes.

Q: What is cooling care function?

A: The Intense Pulsed Light (IPL) System features cooling care function which realized through semiconductor cooling plate, this function auto starts when device is powered on and auto off when device is powered off. The cold side of semiconductor cooling plate contacts Sapphire Cooling Plate which is the surface of Light Exit Window and contact with skin surface directly. Since the temperature of Sapphire Cooling Plate lower than temperature of skin surface, it generates cooling feeling when device contacts with skin surface during it works, this is a physical heat transfer process.

Q: Must I shave hair before each use?

A: No. But you are advised to shave the hair when it is longer than 5mm.

Q: Why my hair still growing after few times treatment? Why it is not falling out immediately after treatment?

A: The Intense Pulsed Light (IPL) System is a home IPL hair removal device which apply very gentle pulses of light to the hair root. It works step by step gradually, first of all, the hair go into its resting phase- the hair you have falls out, and gradually your body grows less hair in that area, and finally, the hair stops growing back, it takes times.

It is a permanent hair remover. Hairs cannot be removed permanently until you have used the device for one period. It can only repress hair growing and slow down hair growing speed at the beginning. The hair enters the sleep state under continuous action. Thus, permanent hair removal effect is achieved.

Q: Why didn't I achieve the same effect as the others, or no effect at all?

A: People have different physiques, and the difference of hair thickness and treated parts can affect the effecting cycle. The using cycle is an average value, of which the specific time may be slightly different.

Q: Which level is suitable?

A: There is no unified standard of the suitable levels, it all depends on how your skin tolerance, the darker the skin color, the lower the level should be used. And start choosing the suitable level from the lowest one. The higher the level is, the more obvious the treatment effect is and the shorter the treating time is. On the contrary, if you use a low level, the treating time will be extended accordingly. It is recommended to do local skin tests on the treated skin part before each hair removal, and then start treatment on large skin areas after, making sure that no skin discomfort occurs on the second day.

Q: Will it hurt?

A: During the hair removal process, light waves will generate heat when encounter hair melanins, causing slight pain. Due to the different skin sensitivity and pain tolerance of different individuals, the actual feelings are different. It is recommended to accelerate the level slowly from the lowest one according to your actual situation.

Q: How to shave? What kinds of hair should be shaved off?

A: Generally speaking, you should shave hair on the armpit parts, bikini parts, and legs before use. The method makes shaving easier:

- 1) Use shaving cream or mild shower gel to lubricate the shaving area
- 2) Or, apply a hot towel on the shaving area for a few minutes, and gently shave the hair immediately after removing the towel, which will make shaving easier.

Q: Why is there a smell of scorched hair after use?

A: That's because the hair is not completely shaved. While using the light waves will generate heat when encounter melanin., which causes the smells of scorched hair. And that is normal.

Q: I want to remove my hair quickly. Can I use the device every day?

A: It is not advised to use the device every day. Hair has a growth cycle; you can use it according to the normal cycle: Use once every two weeks during the first 3 ~ 4 times and gradually decrease the number of using times after the hair growth slows down.

13. Important Information Regarding Electro Magnetic Compatibility (EMC)

⚠ Warning: Using cell phone or microwave oven, HF surgical equipment, magnetic resonance imaging or other radio radiant equipment near this device may cause malfunction or lead to loss of essential performance.

⚠ Warning: Use of this equipment adjacent to or stacked with other equipment should be avoided because it could result in improper operation. If such use is necessary, this equipment and the other equipment should be observed to verify that they are operating normally.

⚠ Warning: Use of adapter other than those specified or provided by the manufacturer of this equipment could result in increased electromagnetic emissions or decreased electromagnetic immunity of this equipment and result in improper operation.

⚠ Warning: Portable RF communications equipment (including peripherals such as antenna cables and external antennas) should be used no closer than 30 cm (12 inches) to any part of Intense Pulsed Light (IPL) System, including cables specified by the manufacturer. Otherwise, degradation of the performance of this equipment could result.

Table 1

Guidance and manufacture's declaration – electromagnetic emission		
The device is intended for use in the electromagnetic environment specified below. The customer of the user of the device should assure that it is used in such an environment.		
Emission test	Compliance	Electromagnetic environment – guidance
Conducted and Radiated RF emissions CISPR 11	Group 1 Class B	The device uses RF energy only for its internal function. Therefore, its RF emissions are very low and are not likely to cause any interference in nearby electronic equipment.

Conducted RF emissions CISPR 11	Group 1 Class B	The device is suitable for use in all establishments, including domestic and those directly connected to the public low-voltage power supply network that supplies buildings used for domestic purposes except for near active HF surgical equipment and the RF shielded room for magnetic resonance imaging.
Radiated RF emissions CISPR 11	Group 1 Class B	
Harmonic emissions IEC 61000-3-2	Class A	
Voltage fluctuations and flicker emissions IEC 61000-3-3	Applicable	

Table 2

Guidance and Manufacturer's declaration – electromagnetic immunity			
The device is intended for use in the electromagnetic environment specified below. The customer or the user of the device should assure that it is used in such an environment.			
Immunity test	IEC 60601-1-2 test level	Compliance level	Electromagnetic environment-guidance
Electrostatic discharge IEC 61000-4-2	±8kV contact; ±2kV, ±4kV, ±8kV, ±15 kV air	±8kV contact; ±2kV, ±4kV, ±8kV, ±15kV air	Floors should be wood, concrete or ceramic tile. If floors are covered with synthetic material, the relative humidity should be at least 30%.
Radiated RF EM fields IEC 61000-4-3	3V/m (Professional healthcare facility environment); 10V/m (Home healthcare environment), 80MHz – 2.7GHz 80% AM at 1kHz	10V/m (Home healthcare environment) 80MHz – 2.7GHz 80% AM at 1kHz	

Electrical fast transients/bursts IEC 61000-4-4	±2kV AC power supply lines; ±1kV DC power/Signal lines. 100 kHz repetition frequency	±2kV AC power supply lines;	Mains power quality should be that of a HOME HEALTHCARE ENVIRONMENT or a Professional healthcare facility environment.
Surges IEC 61000-4-5	±0.5kV, ±1kV lines to lines; ±0.5kV, ±1kV, ±2kV lines to earth	±0.5kV, ±1kV lines to lines;	Mains power quality should be that of a HOME HEALTHCARE ENVIRONMENT or a Professional healthcare facility environment.
Conducted disturbances induced by RF fields IEC 61000-4-6	3V 0.15MHz –80MHz, 6V in ISM bands between 0.15MHz and 80MHz (Professional healthcare facility environment), 6V in ISM and amateur radio bands between 0.15MHz and 80MHz (Home healthcare environment) 80% AM at 1kHz	Applicable	
Note: The ISM (industrial, scientific and medical) bands between 0,15 MHz and 80 MHz are 6,765 MHz to 6,795 MHz; 13,553 MHz to 13,567 MHz; 26,957 MHz to 27,283 MHz; and 40,66 MHz to 40,70 MHz. The amateur radio bands between 0,15 MHz and 80 MHz are 1,8 MHz to 2,0 MHz, 3,5 MHz to 4,0 MHz, 5,3 MHz to 5,4 MHz, 7 MHz to 7,3 MHz, 10,1 MHz to 10,15 MHz, 14 MHz to 14,2 MHz, 18,07 MHz to 18,17 MHz, 21,0 MHz to 21,4 MHz, 24,89 MHz to 24,99 MHz, 28,0 MHz to 29,7 MHz and 50,0 MHz to 54,0 MHz.			

Rated power frequency magnetic fields IEC 61000-4-8	30A/m 50Hz or 60Hz	30A/m 50Hz	Power frequency magnetic fields should be at levels characteristic of a HOME HEALTHCARE ENVIRONMENT or a Professional healthcare facility environment.
Voltage dips IEC 61000-4-11	0% UT, 0.5 cycle At 0°, 45°, 90°, 135°, 180°, 225°, 270° and 315°; 0% UT, 1 cycle and 70% UT, 25/30 cycle Single phase: at 0°	Applicable	Mains power quality should be that of a HOME HEALTHCARE ENVIRONMENT or a Professional healthcare facility environment...
Voltage interruptions IEC 61000-4-11	0% UT, 250/300 cycle	Applicable	
NOTE: UT is the a.c. mains voltage prior to application of the test level. E.g.: 25/30 means 25 periods at 50 Hz or 30 periods at 60 Hz.			

Table 3

Guidance and Manufacturer's declaration – electromagnetic immunity			
The device is intended for use in the electromagnetic environment specified below. The customer or the user of the device should assure that it is used in such an environment.			
Immunity test	IEC 60601-1-2 test level	Compliance level	Electromagnetic environment - guidance

Proximity fields from RF wireless communications equipment IEC 61000-4-3	See the following table	Complies	
---	-------------------------	----------	--

Test specifications for ENCLOSURE PORT IMMUNITY to RF wireless communications equipment

Test frequency (MHz)	Band ^{a)} (MHz)	Service ^{a)}	Modulation ^{b)}	Maximum power (W)	Distance (m)	Immunity Test Level (V/m)
385	380 - 390	TETRA 400	Pulse modulation ^{b)} 18 Hz	1,8	0,3	27
450	430 – 470	GMRS 460, FRS 460	FM ^{c)} ± 5 kHz deviation 1 kHz sine	2	0,3	28
710	704 – 787	LTE Band 13, 17	Pulse modulation ^{b)} 217 Hz	0,2	0,3	9
745						
780						
810	800 – 960	GSM 800/900, TETRA 800, iDEN 820, CDMA 850, LTE Band 5	Pulse modulation ^{b)} 18 Hz	2	0,3	28
870						
930	1700 – 1990	GSM 1800; CDMA 1900; GSM 1900; DECT; LTE Band 1, 3, 4, 25; UMTS	Pulse modulation ^{b)} 217 Hz	2	0,3	28
1720						
1845						
1970						

2450	2400 – 2570	Bluetooth, WLAN, 802.11 b/ g/n, RFID 2450, LTE Band 7	Pulse modulation ^{b)} 217 Hz	2	0,3	28
5240	5100 – 5800	WLAN 802.11 a/n	Pulse modulation ^{b)} 217 Hz	0,2	0,3	9
5500						
5785						

NOTE If necessary to achieve the IMMUNITY TEST LEVEL, the distance between the transmitting antenna and the ME EQUIPMENT or ME SYSTEM may be reduced to 1 m. The 1 m test distance is permitted by IEC 61000-4-3.

- a. For some services, only the uplink frequencies are included.
b. The carrier shall be modulated using a 50 % duty cycle square wave signal.
c. As an alternative to FM modulation, 50 % pulse modulation at 18 Hz may be used because while it does not represent actual modulation, it would be worst case.

table 4

Recommended separation distances between portable and mobile RF communication equipment and The device			
The device is intended for use in an electromagnetic environment in which radiated RF disturbances are controlled. The customer or the user of the devices can help prevent electromagnetic interference by maintaining a minimum distance between portable and mobile RF communications equipment (transmitters) and the device as			
Rated maximum output power of transmitter/ W.	Separation distance according to frequency of transmitter/m		
	150kHz ~ 80MHz $d = 1.2\sqrt{P}$	80MHz ~ 800MHz $d = 1.2\sqrt{P}$	800MHz ~ 2.5GHz $d = 2.3\sqrt{P}$
0.01	0.12	0.12	0.23
0.1	0.38	0.38	0.73
1	1.2	1.2	2.3
10	3.8	3.8	7.3
100	12	12	23

For transmitters rated at a maximum output power not listed above, the recommended separation distance d in meters (m) can be estimated using the equation applicable to the frequency of the transmitter, where P is the maximum output power rating of the transmitter in watts(W) according to the transmitter manufacturer.

NOTE 1 At 80MHz and 800MHz, the separation distance for the higher frequency range applies.

NOTE 2 These guidelines may not apply in all situations. Electromagnetic propagation is affected by absorption and reflection from structures, objects and people.

Operation Record

Operation site: _____ Level: _____

No.	Date	Remark
1		
2		
3		
4		
5		
6		
7		
8		
9		
10		

Operation Record

Operation site: _____ Level: _____

No.	Date	Remark
1		
2		
3		
4		
5		
6		
7		
8		
9		
10		

Operation Record

Operation site: _____ Level: _____

No.	Date	Remark
1		
2		
3		
4		
5		
6		
7		
8		
9		
10		

Operation Record

Operation site: _____ Level: _____

No.	Date	Remark
1		
2		
3		
4		
5		
6		
7		
8		
9		
10		

说明书骑马订装
尺寸：90 X 130mm
封面157g铜版纸
内页105g 铜板纸
四色印刷
公差±2mm