

BOSS[®]



EXTENDED END CANTILEVER

Tower Scaffold
3T - Through the Trapdoor Method

USER GUIDE

Contents

Safety First	2
Component Diagram	11
Component Quantity & Safety Data Schedule	12
Build Method	16
Pre-use Safety Inspection Checklist	29

Safety First

Introduction

Please read this guide carefully.

Please note that diagrams are for illustrative purposes only.

User guides are also available to download from our website at www.bossaccesstowers.com

BoSS mobile aluminium towers are light-weight scaffold towers used throughout the building and construction industry for both indoor and outdoor access solutions where a stable and secure platform is required. Ideal for maintenance and installation work or short-term access, the highly versatile towers provide a strong working platform for a variety of heights.

The law requires that personnel erecting, dismantling, using or altering towers must be competent. Any person erecting or using a BoSS mobile tower must have a copy of this user guide. For further information on the use of mobile access and working towers consult the PASMA operators code of practice.

Verification and assessment documentation is held by Werner Sales & Distribution Ltd.

If you need further information, design advice, additional user guides or any other help with this product, please contact the manufacturer on **+44 (0)1621 745900** or email **uk.customercare@wernerco.com**.

Safety First

Safe use

- Check overhead that the area into which the structure is to be erected contains no obstructions, particularly electrical or radio radiation hazards.
- The structure is highly conductive and must not be used when there is a risk of lightning strikes.
- Ensure the ground on which the mobile access tower is to be erected is capable of supporting the tower in use.
- Before each use:
 - Check that each prefabricated tower scaffold is complete and correctly assembled.
 - Check that the prefabricated tower scaffold is vertical and make any adjustments as required.
 - Check that no environment changes will affect the safe use of the structure.
- Adjustable legs should only be used for levelling purposes and never to gain extra height.
- Do not use ladders, steps, boxes or similar, to gain additional working height.
- Only climb the tower from the inside using the access method provided.
- Tower scaffolds are not designed to be lifted or suspended.
- Beware of horizontal forces (e.g. power tools) which could generate instability.

Maximum horizontal force per working bay = 30kg

- Tools and materials should be lifted using a reliable lifting material (e.g. a strong rope) employing a reliable knot (e.g. clove hitch) to ensure safe fastening and always lift within the footprint of the prefabricated tower scaffold (i.e. within the area bounded by the stabilisers).
- Use good manual handling techniques when handling tower components.
- Safe working loads, normally expressed in kN/m², are expressed on the next page in kg per defined working area.

Safety First

Safe use

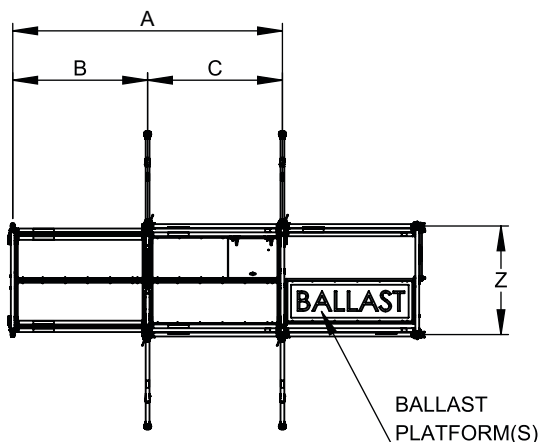

1.8m long main tower with 1.8m long cantilever

Defined working area	Max. safe working load (uniformly distributed including persons)	Load class	Max. no. of persons*
A x Z	624 kg	2	2
B x Z	312 kg		
C x Z	312 kg		

2.5m long main tower with 1.8m long cantilever

Defined working area	Max. safe working load (uniformly distributed including persons)	Load class	Max. no. of persons*
A x Z	752 kg	2	2
B x Z	312 kg		
C x Z	440 kg		

*Persons are assumed to be 122kg (Reference to HSE - Revision of body size criteria in standards Protecting people who work at height - Research report 342)

Safety First

Access classes

The Access Class provided for climbing this tower is: Access Class 'D' (Vertical Ladder).

Lifting of individual tower components

- Raising and lowering components, tools and/or materials by rope should be conducted within the tower base (i.e. within the area bounded by the stabilisers). Ensure that the safe working load of the supporting decks and the tower structure is not exceeded.

Movement of the assembled prefabricated tower scaffold

Ensure gloves or other suitable hand protection is worn.

Before

The safe movement of any prefabricated tower scaffold shall be included in a specific risk assessment and take into account:

- Ground surface (such as potholes, unstable surfaces, inclines).
- Overhead obstructions (such as live electrical cables or building members).
- Wind conditions.
- Dimensions of the tower structure (a shorter tower will be more stable during movement - see PASMA guidance).
- Consequences of overturning.

If the site conditions are not adequate to permit the safe movement of a mobile tower structure, then it must not be moved.

During

Mobile tower structures shall be moved with the utmost caution:

- Remove cantilever by reversing assembly steps 12, 11 and 10.
- Remove ballast.
- Any stabilisers fitted must remain in position and raised no more than 25mm from the ground.
- Prefabricated tower structures must only be pushed using manual effort at or near the base.
- Movement of a mobile tower structure shall be no faster than 0.25 m/s (very slow walking pace) and sufficient number of persons shall be used to ensure the movement is fully under control.
- No persons, tools or materials shall be left on the mobile tower structure during movement.

Safety First

Movement of the assembled prefabricated tower scaffold

- Ensure all castors are unlocked.
- Beware of ground level and overhead obstructions, uneven or sloping ground, sudden changes of levels (holes, voids, kerbs).

After

- Ensure all castors are locked.
- Reposition stabilisers as per assembly step 6.
- Replace ballast as per assembly step 7.
- Replace cantilever as per assembly steps 10, 11 and 12.
- The pre-use checklist on the final page shall be used to determine tower integrity.

Maintenance - Storage - Transport

- All components and their parts should be regularly inspected to identify damage, particularly to joints. Lost or broken parts should be replaced and any tubing with indentation greater than 5mm shall be replaced. Adjustable leg threads should be cleaned and lightly lubricated to keep them free running.
- Brace claws, frame interlock clips, trapdoor latches, camlocks and platform wind-locks should be regularly checked to ensure they lock correctly.
- Refer to the BoSS Inspection Manual for detailed inspection and maintenance advice: www.bossacesstowers.com
- Components should be stored in clean, dry conditions with due care to prevent damage.
- Ensure components are not damaged by excessive strapping forces when transported.

Ballast Weights

Ballast should always be fitted when specified. Ballast must be of solid materials (i.e. not sand, water or other liquid or granular materials) and must be securely attached to the tower structure. Ballast weights placed at the base of the structure will increase tower self-weight, thereby increasing stability. Care must be taken to ensure that the weight of the ballast weights used is known, and that the total safe load on the structure, and particularly on the castors, is not exceeded. Use good manual handling techniques when handling ballast. See quantity schedule on pages 12 to 15 for ballast information.

Note: Ballast weights must be uniformly distributed to a maximum of 275kg per deck.

Safety First

During assembly, use and dismantling

- As part of the risk assessment, wind conditions must be taken into account and reviewed regularly, depending on the duration the structure is onsite.
- The structure has been assessed for wind loads equating to 27mph (43kph, 12m/s).
- The effect of wind conditions on site must be considered prior to the assembly of a tower. The tower must not be used in wind speeds beyond 27mph. If greater wind speeds are forecast, the tower must be dismantled while it is still safe to do so.
- Sheets, tarpaulins, cladding or similar, must not be attached to the tower as these will significantly increase any side loads from wind and will potentially make the tower unstable.
- Beware of wind turbulence, funnelling effects around buildings and updraughts on stairways.

The maximum allowable side load on a tower is 30kg.

- **CAUTION:** Excessive side loads due to working from the tower may cause the structure to become unstable. Special consideration should be given to side loads including vibrations.
- Do not abuse equipment. Damaged, incorrect or incompatible components should not be used.
- The structure is highly conductive and must not be used when there is a risk of lightning strikes.
- Exercise caution when touching unprotected metal components in extreme high or low temperatures.
- If the tower is damaged in any way while in service, it must not be used again until the damaged components are replaced.

Wind description	Beaufort scale	Beaufort no.	Speed in mph	Speed in m/sec
Medium Breeze	Raises dust and loose paper, twigs snap off	4	8-12	4-6
Strong Breeze	Large branches in motion, telegraph wires whistle	6	25-31	11-14
Gale Force	Walking is difficult	8	39-46	17-21

Safety First

Ties

This structure is designed to be self-supporting under the loading condition requirements of BS 1139-6:2014 and does not require tying in. Consideration should be given to potential wind conditions if the tower is left unattended - see 'During Assembly, Use and Dismantling' section above.

Tower designation & safety data

In accordance with the prefabricated tower scaffold standards, the 'Tower Designation & Safety Data' shall be positioned at the base of the prefabricated tower scaffold as shown within the user guide, by means of the 'Tower Designation Information Assembly'. It must be clearly visible so that users are aware of the conditions of safe use. Refer to Safety Data Schedule for content.

Stabilisers

Stabilisers shall always be fitted when specified. See quantity schedule on pages 12 to 15.

Attach one stabiliser to each corner of the tower as shown.

Position the lower clamp so that the lower arm is as close to horizontal as possible. Adjust the position of the upper clamp to ensure the stabiliser foot is in contact with the ground. Ensure clamps are secure. Telescopic stabilisers must always be fully extended.

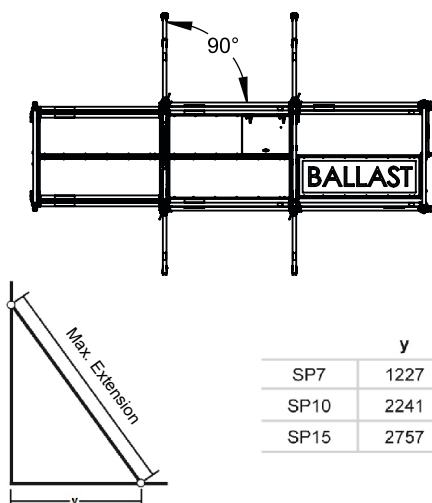

Safety First

Assembly Procedure

This tower structure must be assembled, and components oriented, in accordance with this instruction manual.

Deviation from this user guide is not permitted.

A minimum of two persons are recommend for assembly and disassembly of this prefabricated tower structure. The maximum number of persons permitted on the tower during assembly is stated in the safety data schedule.

Platforms must be installed with vertical distances between them not exceeding 2m when assembling and dismantling. The maximum number of people on a working platform level permitted to simultaneously exert a horizontal load of 30kg is:

- **1 person per bay for bays less than 4m long**
- **2 persons per bay for bays greater than 4m in length**

Check that all components, tools and safety equipment are onsite (refer to quantity schedule), undamaged and that they are functioning correctly, particularly the brace claw locking mechanism.

Full inspection guidance can be found at www.bossacesstowers.com. Damaged or incorrect components must not be used.

Component weights can be found in the quantity schedule and on the corresponding BoSS Product Datasheets.

Check that the ground on which the tower structure is to be erected and moved is capable of supporting the tower in use and within the levelling limits of the tower system.

Check overhead that the area into which the tower structure is to be built contains no obstructions, particularly electrical or radio radiation hazards.

When positioning the tower take into account risk of collision with the tower e.g. from pedestrians, vehicles or doors. Secure doors (not fire exits) and windows where possible in the work area.

Never stand on an unguarded platform positioned above the first rung of a tower structure. If your risk assessment shows it necessary, you may also need to guardrail platforms at this level.

Safety First

Assembly Procedure

Tower components should be lifted using a reliable lifting material (e.g. a strong rope) employing a reliable knot (e.g. clove hitch) to ensure safe fastening and always lift within the footprint of the tower structure.

'Tower Designation & Safety Data' content for the 'Tower Designation Information Assembly' can be found in the 'Safety Data Schedule'. This assembly must be positioned at the base of the prefabricated tower scaffold and clearly visible for users. Refer to Safety Data Schedule for content.

Adjustable legs should only be used for levelling purposes and never to gain extra height.

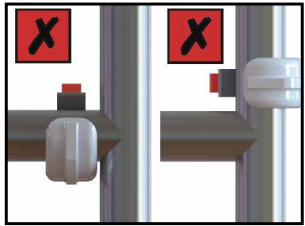
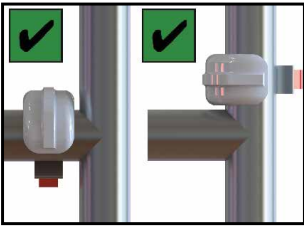

Ensure horizontal braces and guardrails are fitted correctly.

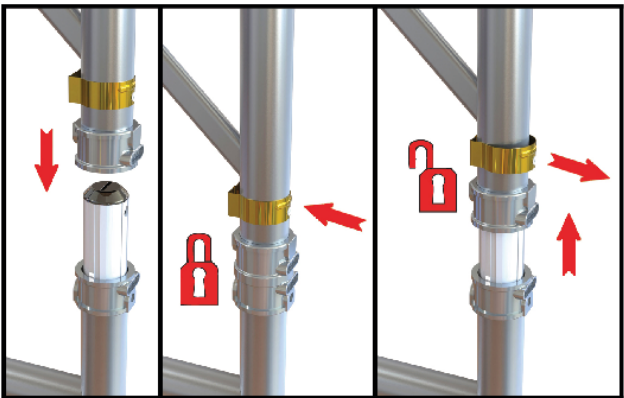

Ensure interlock clips on frame members are in the 'locked' position.

Safety First

Assembly Procedure

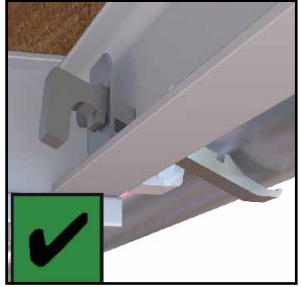
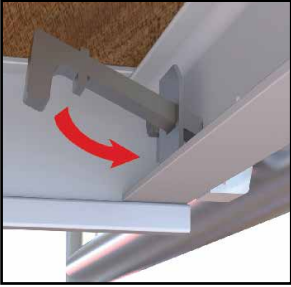

Ensure wind-locks are engaged before moving onto the deck levels.

Component Diagram

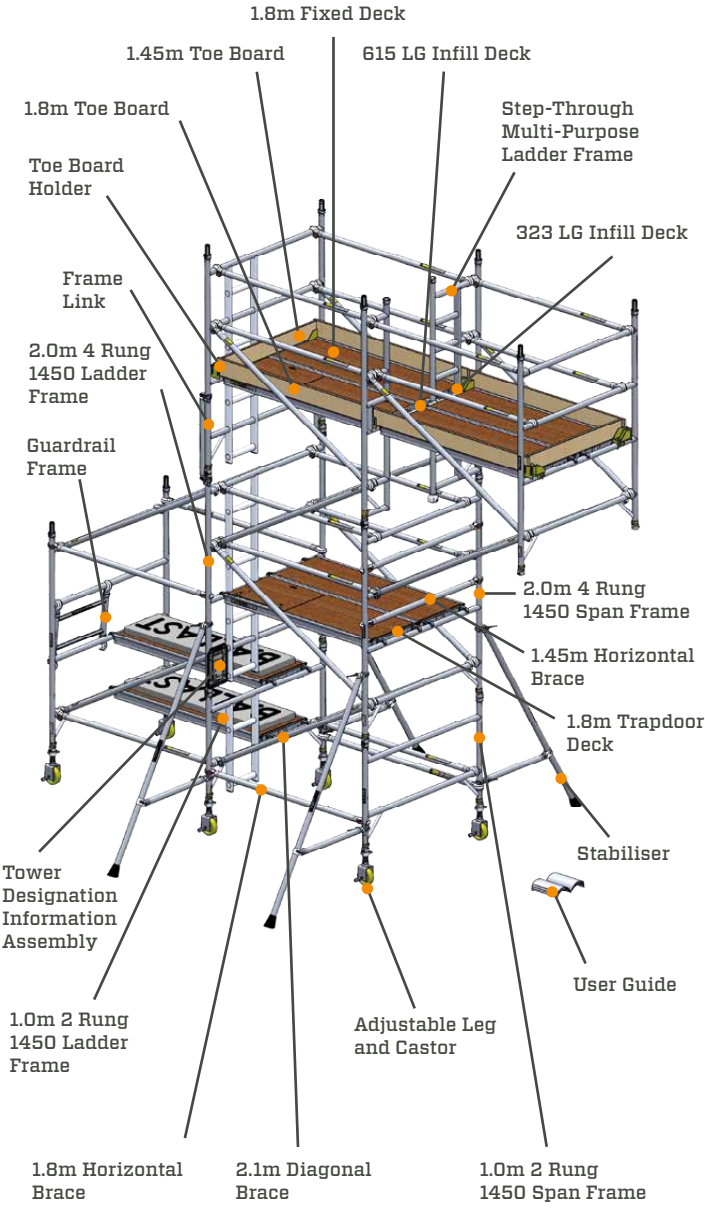

Component Quantity & Safety Data Schedule

BoSS extended end 1.8m cantilever tower scaffold - 1.8m long main tower with 1.8m long cantilever

Component code	Component description and weight	Composite code	Internal or external use												
			34002200	34002700	34003200	34003700	34004200	34004700	34005200	34005700	34006200				
			Working height (m) >	Platform height (m) >	4.2	4.7	5.2	5.7	6.2	6.7	7.2	7.7	8.2		
33551300	Adjustable Leg		6	6	6	6	6	6	6	6	6	6	6	6	6
32842300	Ø150mm (6") Castor		6	6	6	6	6	6	6	6	6	6	6	6	6
60551300	Span Frame Mk2 - 1.0m - 2 Rung - 1450 Wide		1	-	-	1	1	1	-	-	-	-	-	1	1
60451300	Span Frame Mk2 - 1.5m - 3 Rung - 1450 Wide		-	1	-	1	1	-	1	-	-	-	-	1	-
60351300	Span Frame Mk2 - 2.0m - 4 Rung - 1450 Wide		2	2	3	2	2	3	3	4	3	4	3	4	4
61151300	Ladder Frame Mk3 - 1.0m 2 Rung - 1450 Wide		1	-	-	1	1	-	-	-	-	-	-	1	1
61051300	Ladder Frame Mk3 - 1.5m 3 Rung - 1450 Wide		-	1	-	1	1	-	1	-	-	-	-	1	-
60951300	Ladder Frame Mk3 - 2.0m 4 Rung - 1450 Wide		1	1	2	1	2	2	2	3	2	3	2	3	3
39951300	Step-Through Multi-Purpose Ladder Frame		1	1	1	1	1	1	1	1	1	1	1	1	1
63851400	Guardrail Frame		1	1	1	1	1	1	1	1	1	1	1	1	1
34651300	1.45m Horizontal Brace		2	2	2	2	2	2	2	2	2	2	2	2	2
31251300	1.8m Horizontal Brace		15	19	19	19	19	19	23	23	23	23	23	23	23
31351300	2.1m Diagonal Brace		12	14	14	14	16	16	18	18	18	18	20	20	20
30151100	1.8m Fixed Deck		5	7	6	6	6	6	7	6	7	6	7	7	7
30451100	1.8m Trapdoor Deck		1	1	2	2	2	2	2	3	3	3	3	3	3
31751300	Stabiliser - SP7 - Saddle Blade Clamp		4	4	4	4	4	4	-	-	-	-	-	-	-
31851300	Stabiliser - SP10 - Saddle Blade Clamp		-	-	-	-	-	-	4	4	4	4	4	4	4
34051600	0.89m Brace Assembly		-	-	-	-	-	-	2	2	2	2	2	2	2
35851100	0.6m Infill Deck		1	1	1	1	1	1	1	1	1	1	1	1	1
35751100	0.3m Infill Deck		1	1	1	1	1	1	1	1	1	1	1	1	1
30150900	Toe Board Holder		6	6	6	6	6	6	6	6	6	6	6	6	6
30350900	1.45m End Toe Board Holder		2	2	2	2	2	2	2	2	2	2	2	2	2
30450900	1.8m Side Toe Board		4	4	4	4	4	4	4	4	4	4	4	4	4
30001900	Tower Designation Information Kit		-kg	1	1	1	1	1	1	1	1	1	1	1	1
03302400	User Guide		1	1	1	1	1	1	1	1	1	1	1	1	1

Component Quantity & Safety Data Schedule

Total Self-weight of Tower (kg)	242	282	286	296	303	351	356	378	385
Ballast internal use (kg)	190	200	210	220	230	240	250	260	270
Ballast external use (kg)	290	330	360	400	430	480	530	580	630
Max. Exerted leg load internal use (kg)	400	400	400	410	410	410	410	420	420
Max. Exerted leg load external use (kg)	400	400	400	410	410	410	420	420	430
Max. No. of persons on any one platform unit	2	2	2	2	2	2	2	2	2
Max. No. of persons permitted on the tower during assembly and dismantling	2	2	2	2	2	2	2	2	2
Max. No. of simultaneous working platforms permitted	1	1	1	1	1	1	1	1	1
Max. No. of persons permitted on the working platform during use									
Highest working platform during use	2	2	2	2	2	2	2	2	2
2nd/3rd/4th/5th/6th highest working platform during use	-	-	-	-	-	-	-	-	-
Max. Safe working load on the working platform (kg u.d.l.)									
highest working platform (kg u.d.l.)	624	624	624	624	624	624	624	624	624
2nd/3rd/4th/5th/6th highest working platform (kg u.d.l.)	-	-	-	-	-	-	-	-	-
Max. Safe Working Load on the entire tower scaffold (kg u.d.l.)	624	624	624	624	624	624	624	624	624
Max. working platform height for internal use (m)	2.2	2.7	3.2	3.7	4.2	4.7	5.2	5.7	6.2
Max. working platform height for external use (m)	2.2	2.7	3.2	3.7	4.2	4.7	5.2	5.7	6.2
Design standard	BS1139-6	BS1139-6	BS1139-6	BS1139-6	BS1139-6	BS1139-6	BS1139-6	BS1139-6	BS1139-6
Load class	2	2	2	2	2	2	2	2	2
Access class	D	D	D	D	D	D	D	D	D
Clear height class	-	H ₂	H ₂	H ₂	H ₂	H ₂	H ₂	H ₂	H ₂

NOTE:

The safety data specified within the schedule above which relates to the specific tower to be assembled must be transferred into the pre-defined boxes on the Tower Designation Information insert found in the Tower Designation Information Kit.

Component Quantity & Safety Data Schedule

BoSS extended end 1.8m cantilever tower scaffold - 2.5m long main tower with 1.8m long cantilever

Component code	Component description and weight	Internal or external use															
		34102200	34102700	34105200	34105700	34106200	34106700	34107200	34107700	34108200	34108700	34109200					
		4.2	4.7	5.2	5.7	6.2	6.7	7.2	7.7	8.2	8.7	9.2					
33551300	Adjustable Leg 1.1kg	6	6	6	6	6	6	6	6	6	6	6	6	6	6	6	6
32842300	Ø150mm (6") Castor 3.3kg	6	6	6	6	6	6	6	6	6	6	6	6	6	6	6	6
60551300	Span Frame Mk2 - 1.0m - 2 Rung - 1450 Wide 4.0kg	1	-	-	1	1	1	1	1	1	1	1	1	1	1	1	1
60451300	Span Frame Mk2 - 1.5m - 3 Rung - 1450 Wide 5.6kg	-	1	-	-	-	1	1	1	1	1	1	1	1	1	1	1
60351300	Span Frame Mk2 - 2.0m - 4 Rung - 1450 Wide 7.1kg	2	2	3	2	3	2	3	3	3	3	4	3	3	3	3	4
61151300	Ladder Frame Mk3 - 1.0m 2 Rung - 1450 Wide 5.4kg	1	-	-	1	1	1	1	1	1	1	1	1	1	1	1	1
61051300	Ladder Frame Mk3 - 1.5m 3 Rung - 1450 Wide 8.0kg	-	1	-	-	-	1	1	1	1	1	1	1	1	1	1	1
60951300	Ladder Frame Mk3 - 2.0m 4 Rung - 1450 Wide 10.4kg	1	1	2	1	2	1	2	2	2	2	3	2	2	2	3	3
39951300	Step-Through Multi-Purpose Ladder Frame 12.0kg	1	1	1	1	1	1	1	1	1	1	1	1	1	1	1	1
63851400	Guardrail Frame 3.4kg	1	1	1	1	1	1	1	1	1	1	1	1	1	1	1	1
34651300	1.45m Horizontal Brace 1.7kg	2	2	2	2	2	2	2	2	2	2	2	2	2	2	2	2
31251300	1.8m Horizontal Brace 2.0kg	8	8	8	8	8	8	8	8	8	8	8	8	8	8	8	8
31351300	2.1m Diagonal Brace 2.1kg	8	8	8	8	8	8	8	8	8	8	8	8	8	8	8	8
34851300	2.5m Horizontal Brace 2.4kg	7	11	11	11	11	11	11	11	11	15	15	15	15	15	15	15
31451300	2.7m Diagonal Brace 2.5kg	4	6	6	6	6	6	6	6	6	8	10	10	10	12	12	12
30151100	1.8m Fixed Deck 11.8kg	3	3	3	3	3	3	3	3	3	4	4	4	4	4	4	4
30251100	2.5m Fixed Deck 16.0kg	1	1	1	1	1	1	1	1	1	1	1	1	1	1	1	1
30351100	2.5m Trapdoor Deck 16.3kg	1	1	1	1	1	1	1	1	1	1	1	1	1	1	1	1
31751300	Stabiliser - SP7 - Saddle Blade Clamp 3.8kg	4	4	4	4	4	4	4	4	4	4	4	4	4	4	4	4
31851300	Stabiliser - SP10 - Saddle Blade Clamp 8.8kg	-	-	-	-	-	-	-	-	-	-	-	-	-	-	-	-
34051600	0.6m Brace Assembly 1.6kg	-	-	-	-	-	-	-	-	-	-	-	-	-	-	-	-
35851100	0.6m Infill Deck 0.9kg	1	1	1	1	1	1	1	1	1	1	1	1	1	1	1	1
35751100	0.3m Infill Deck 0.6kg	1	1	1	1	1	1	1	1	1	1	1	1	1	1	1	1
30150900	Toe Board Holder 0.3kg	6	6	6	6	6	6	6	6	6	6	6	6	6	6	6	6
30350900	1.45m End Toe Board 2.1kg	2	2	2	2	2	2	2	2	2	2	2	2	2	2	2	2
30450900	1.8m Side Toe Board 3.2kg	2	2	2	2	2	2	2	2	2	2	2	2	2	2	2	2
30550900	2.5m Side Toe Board 4.4kg	2	2	2	2	2	2	2	2	2	2	2	2	2	2	2	2
30001900	Tower Designation Information Kit - kg	1	1	1	1	1	1	1	1	1	1	1	1	1	1	1	1
03302400	User Guide - kg	1	1	1	1	1	1	1	1	1	1	1	1	1	1	1	1

Component Quantity & Safety Data Schedule

Total Self-weight of tower (kg)	244	295	299	322	329	384	388	388	405
Ballast internal use (kg)	120	120	130	140	140	140	150	150	160
Ballast external use (kg)	230	250	270	280	300	340	380	380	440
Max. Exerted leg load internal use (kg)	380	380	380	380	380	380	380	380	380
Max. Exerted leg load external use (kg)	400	400	400	400	400	400	400	400	400
Max. No. of persons on any one platform unit	2	2	2	2	2	2	2	2	2
Max. No. of persons permitted on the tower during assembly and dismantling	2	2	2	2	2	2	2	2	2
Max. No. of simultaneous working platforms permitted	1	1	1	1	1	1	1	1	1
Max. No. of persons permitted on the working platform during use									
Highest working platform during use	2	2	2	2	2	2	2	2	2
2nd/3rd/4th/5th/6th highest working platform during use	-	-	-	-	-	-	-	-	-
Max. Safe working load on the working platform (kg u.c.l.)									
Highest working platform (kg u.c.l.)	752	752	752	752	752	752	752	752	752
2nd/3rd/4th/5th/6th highest working platform (kg u.c.l.)	-	-	-	-	-	-	-	-	-
Max. Safe Working Load on the entire tower scaffold (kg u.c.l.)	752	752	752	752	752	752	752	752	752
Max. working platform height for internal use (m)	2.2	2.7	3.2	3.7	4.2	4.7	5.2	5.7	6.2
Max. working platform height for external use (m)	2.2	2.7	3.2	3.7	4.2	4.7	5.2	5.7	6.2
Design standard	BS1139-6	BS1139-6	BS1139-6	BS1139-6	BS1139-6	BS1139-6	BS1139-6	BS1139-6	BS1139-6
Load class	2	2	2	2	2	2	2	2	2
Access class	D	D	D	D	D	D	D	D	D
Clear height class	-	H ₂	H ₂	H ₂	H ₂	H ₂	H ₂	H ₂	H ₂

NOTE:

The safety data specified within the schedule above which relates to the specific tower to be assembled must be transferred into the pre-defined boxes on the Tower Designation Information insert found in the Tower Designation Information Kit.

Build Method

3.2m working platform height shown*



Build pattern - type 1
Tower working
platform heights:
3.2m, 5.2m

3.7m working platform height shown*



Build pattern - type 2
Tower working
platform heights:
3.7m, 5.7m

*Note: Decks and guardrails omitted from views for clarity.

Build Method

2.2m working platform height shown*

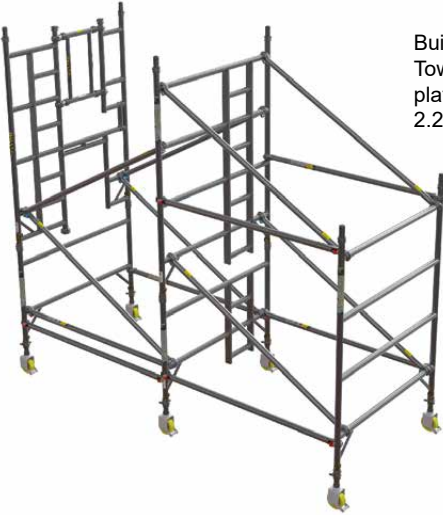

Build pattern - type 3
Tower working
platform heights:
2.2m, 4.2m, 6.2m

2.7m working platform height shown*



Build pattern - type 4
Tower working
platform heights:
2.7m, 4.7m

*Note: Decks and guardrails omitted from views for clarity.

Build Method

When building a BoSS tower

- To comply with 'Work at Height Regulations' we show assembly procedures with platforms every 2 metres in height and the locating of guardrails in advance of climbing onto a platform to increase safety and reduce the risk of a fall.
- Never stand on an unguarded platform positioned above the first rung of a tower. If your risk assessment shows it necessary, you may also need to guardrail platforms at this level.

The procedure illustrated shows a 6.2m working height tower build. For alternative tower height build patterns pages 16 and 17.

The manufacturer recommend two persons are used to build BoSS Towers. Above 4.0m platform height, it is essential that at least two persons are used. Only climb the tower from the inside.

The manufacturer recommend the 'Tower Designation & Safety Data' is recorded within the 'Tower Designation Information Assembly' before proceeding with the tower assembly. Refer to Safety Data Schedule for content.

1 Push castor into adjustable leg. Push castor/leg assembly into the 2 rung frame and lock the castor. Repeat for the other side of the frame. It is recommended, for ease of levelling, that a maximum gap of 50mm is left between the bottom of the leg and the adjustable nut.

Ensure all castors are locked.

Note: Adjustable legs are for levelling only. They are not to be used to gain extra height at the working level.

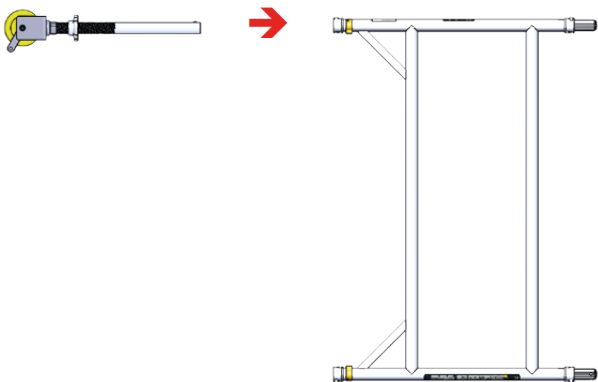

Build Method

- 2** Fit one horizontal brace (red catch) onto the vertical of the 2 rung span frame, just below the bottom rung with the open section of the claw facing outwards.

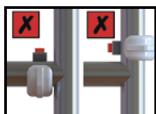
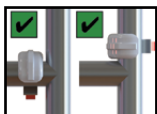
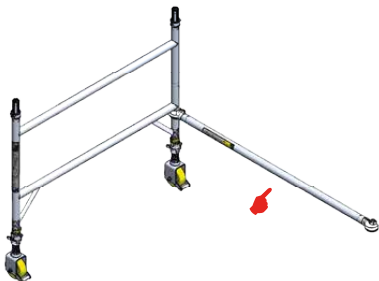

Note: All locking claws must be opened before fitting and positively locked into position.

- 3** Repeat step 1 for the 2 rung ladder frame and position it as shown and fit the other end of the horizontal brace onto the vertical, just below the bottom rung of span frame. Fit the second horizontal brace between the bottom rungs on the other side of the frame to square the structure. Fit additional horizontal brace onto the vertical in position shown.

Ensure all claws are positively locked into position.

The structure must be vertical to within 1cm per metre.

Ensure the frames are vertical and level by checking with a spirit level and setting the adjustable legs as required.

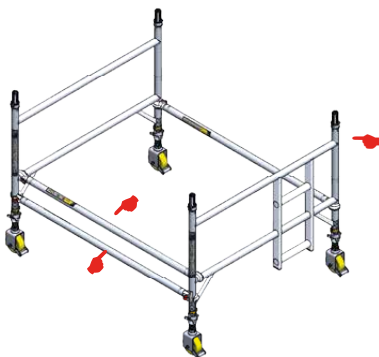

Build Method

4 Fit the 4 rung ladder frame and the 4 rung span frame to the structure base. Fit four diagonal braces in positions shown.

Ensure all claws are positively locked into position. Ensure inbuilt ladders are aligned.

Record 'Tower Designation & Safety Data' within the 'Tower Designation Information Assembly' and attach to the tower in position shown. Refer to safety data schedule for content.

For alternative tower height build patterns see pages 16 and 17.

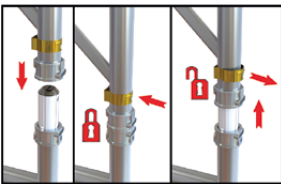
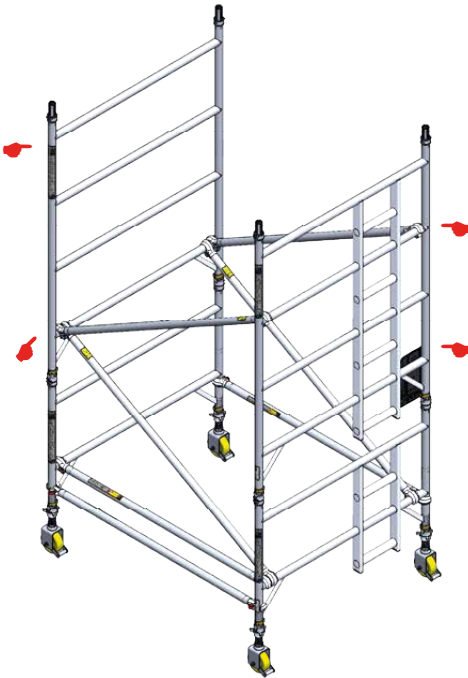

Ensure interlock clips on frame members are in the 'locked' position.

Build Method

5 Fit the trapdoor deck and fixed deck on the fourth rungs of the tower. The trapdoor deck must be oriented such that the trapdoor opens towards the outside of the structure. Ensure the deck wind-locks are engaged.

From the protected trapdoor position, fit guardrails at 0.5m and 1.0m (in that order) above the platform level.

Do not climb on the deck until all guardrails are in place.

Ensure all claws are positively locked into position.

Ensure trapdoor is directly aligned with inbuilt ladder.

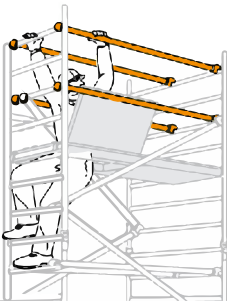
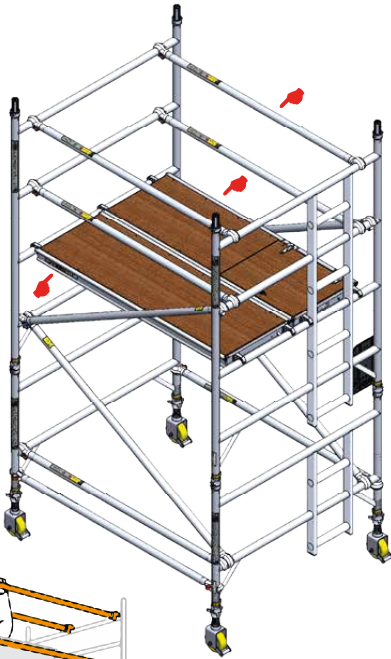

3T - Protected Trapdoor Position

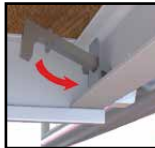

Ensure all wind-locks are engaged.

Build Method

- 6** Fit four stabilisers as shown. See page 8 for details. Telescopic stabilisers must always be fully extended.

Note: Position lower clamps so that the lower arm is as close to horizontal as possible. Adjust the position of the top clamp to ensure the stabiliser foot is in firm contact with the ground. Ensure clamps are secure.



Build Method

7 Fit two castors with adjustable legs to the 4 rung span frame and link to the main frame using 1.8m horizontal and 2.1m diagonal braces. Fit fixed decks as shown to support ballast, refer to table below. Level the whole assembly and ensure castors are locked. Ensure all wind-locks are engaged.

Ensure all claws are positively locked into position.

Note: ballast uniformly distributed to a maximum of 275kg per deck. The tower must be vertical to within 1cm per metre.

For alternative tower height build patterns see pages 17 and 18.

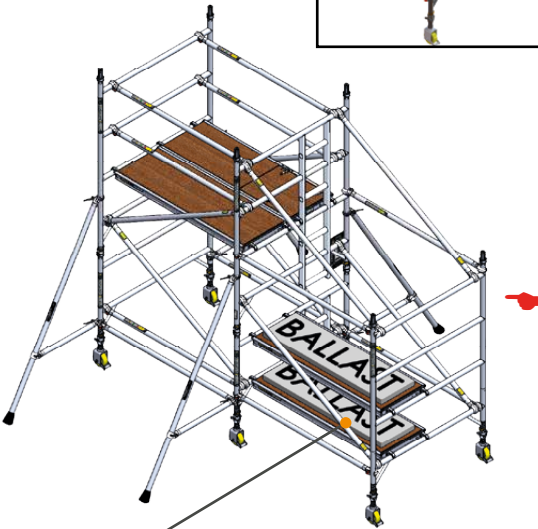
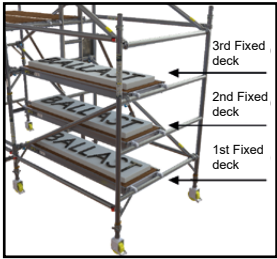

Note: Fit Ballast at this stage. For ballast information, see page 6.

Build Method

Quantity of fixed decks to support ballast 1.8M long main tower with 1.8M long cantilever

Composite code	34002200	34002700	34003200	34003700	34004200	34004700	34005200	34005700	34006200
Working height (m)	4.2	4.7	5.2	5.7	6.2	6.7	7.2	7.7	8.2
Platform height (m)	2.2	2.7	3.2	3.7	4.2	4.7	5.2	5.7	6.2
No. of fixed decks	2	2	2	2	2	2	2	3	3

Quantity of fixed decks to support ballast 2.5M long main tower with 1.8M long cantilever

Composite code	34102200	34102700	34103200	34103700	34104200	34104700	34105200	34105700	34106200
Working height (m)	4.2	4.7	5.2	5.7	6.2	6.7	7.2	7.7	8.2
Platform height (m)	2.2	2.7	3.2	3.7	4.2	4.7	5.2	5.7	6.2
No. of fixed decks	1	1	1	2	2	2	2	2	2

Build Method

8 Fit the guardrail frame to the step-through multi-purpose ladder frame, ensuring all claws are positively locked into position and add the subassembly to the structure. Ensure that the guardrail opens inwards. Fit another 4 rung ladder frame and add two diagonal braces in positions shown. Fit two 0.89m brace assemblies.

Ensure inbuilt ladders are aligned.

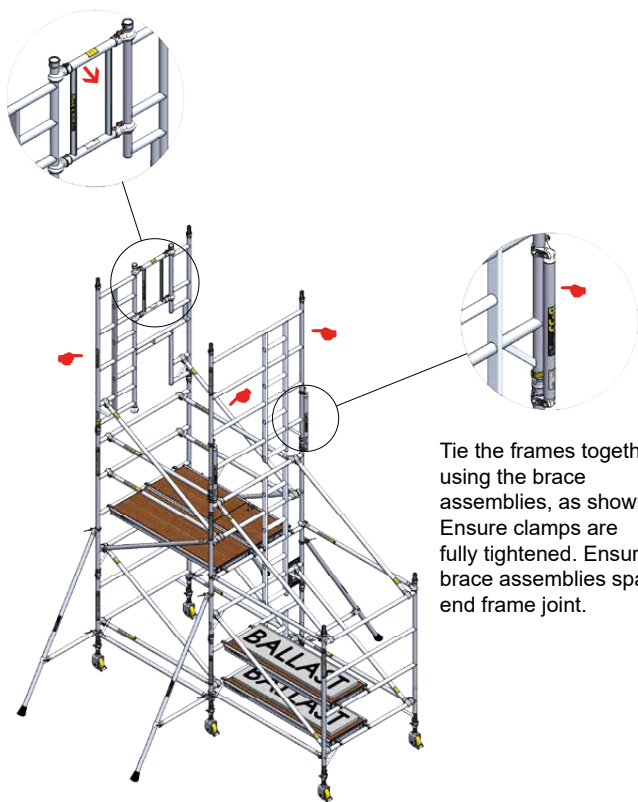

Tie the frames together using the brace assemblies, as shown. Ensure clamps are fully tightened. Ensure brace assemblies span end frame joint.

Build Method

- 9** Fit the fixed deck and trapdoor deck 2.0m above the previous level. Ensure all wind-locks are engaged.

Note the orientation of the trapdoor. From the protected trapdoor position, fit guardrails at 0.5m and 1.0m (in that order) above the platform level. Fit two diagonal braces in positions shown. Fit two 1.45m horizontal braces to span frame, 0.5m and 1.0m below step-through multi-purpose ladder frame as shown.

Ensure all claws are positively locked into position.

Ensure trapdoor is directly aligned with inbuilt ladder as shown.

Do not climb on the deck until all guardrails are in place.

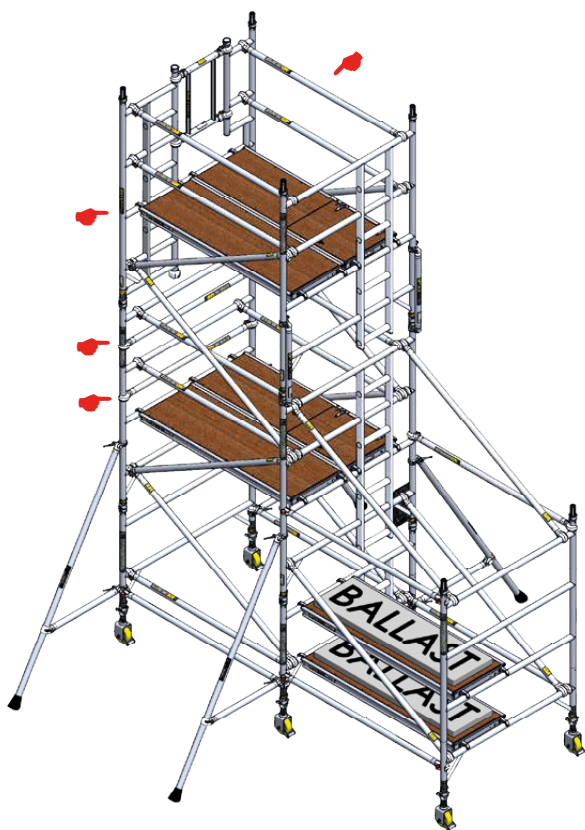

Build Method

- 10** Fit one 4 rung span frame, four diagonal braces and two horizontal braces to form the cantilever structure.

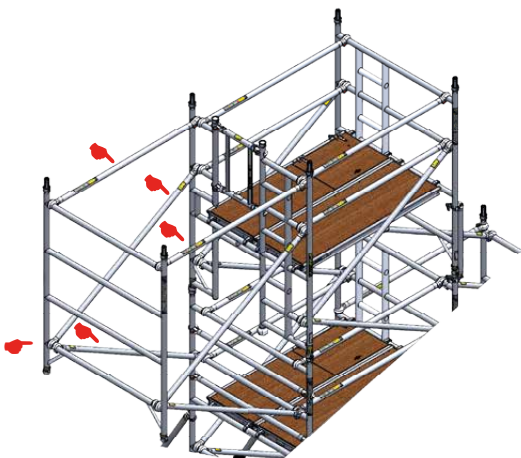

- 11** From the protected position within the main tower, fit two fixed decks. Fit two horizontal braces in positions shown. Ensure all wind-locks are engaged.

Ensure all claws are positively locked into position.

Do not walk out onto the cantilever bay until it is fully assembled and guardrailed.



Build Method

12 Fit the 0.3m and 0.6m infill decks. Fit toe board holders and toe boards around edges of top decks, as shown. Temporary guardrails to be stored in positions shown.

The tower is now complete.

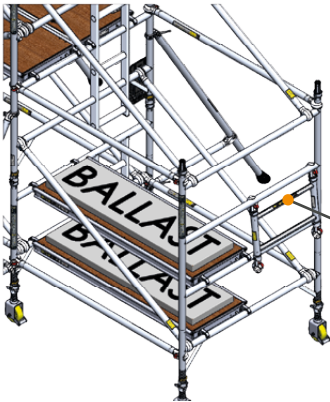
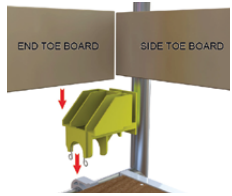
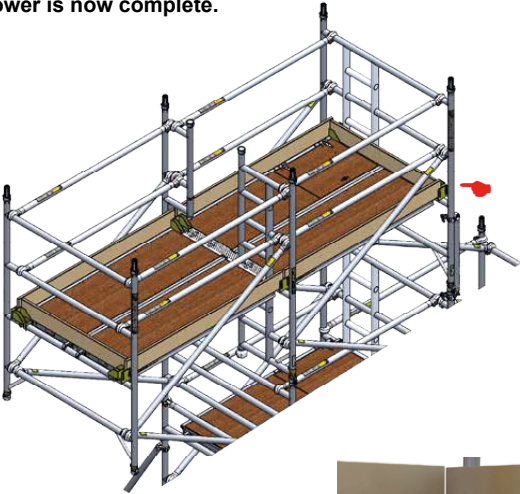

Guardrail frame stored at base

Build Method

To dismantle a BoSS tower:

Simply follow the assembly steps in reverse, ensuring that the 3T method is followed.

Pre-use Safety Inspection Checklist

Description	Yes
Tower structure upright and level	
Castors locked and legs correctly adjusted	
Horizontal and diagonal braces fitted	
Stabilisers and props fitted as specified	
Platforms located and wind-locks engaged	
Interlock clips engaged	
Toe boards located	
Guardrails fitted correctly and positively locked	
Tower designation information kit fitted	
Ballast fitted as specified	

This checklist should be actioned at intervals determined by the manager. This checklist should also be actioned if the tower has been moved or modified, if any damage is suspected or if there are any changes to the local environment that may affect tower stability.

For further information about this product or any other products and services, please contact:

Blackwater Trading Estate,
The Causeway, Maldon,
Essex, CM9 4LJ,
United Kingdom

☎ +44 (0)1621 745900

🖨 +44 (0)1621 859845

✉ uk.customercare@wernerco.com

🌐 bossaccessstowers.com

Members of:



PN03302400

©2019 WernerCo Rev. 02/19