



TITAN 1000 REAR SEAT

(will fit E-Z-GO® TXT®)

ITEMS INCLUDED

- Hardware Packs 1-7
- Grab Bar
- Lean Back Brackets
- Footrest
- Bagwell Brackets
- Main Brackets
- Main Frame
- Arm Rests

TOOLS NEEDED

- Drill
- 17mm Wrench
- 17mm Socket
- #3 Phillips Bit
- 14 mm Socket
- 10mm Socket
- 3/8" Drill Bit
- 13mm wrench

NOT REQUIRED when using seat cushions supplied with this seat kit



Use this bracket only when installing custom cushions such as TSUNAMI, or similar



Bagwell Bracket



Armrests



Footrest



Main Bracket



Main Frame



Grab Bar

WARNING:

We recommend professional installation. If you choose not to have this product installed by a professional, we highly recommend that you exercise caution, care, and patience when installing this product as it involves drilling holes into your cart's body.

STEP 1

Remove struts and basket assembly. Remove hardware from struts and detach canopy. Use a brace to support the canopy. Retain hardware.

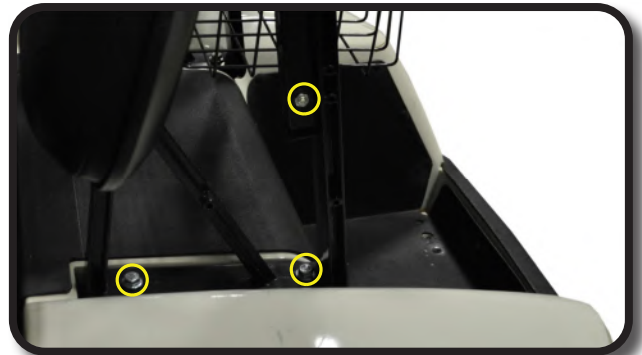

STEP 2

Attach main seat bracket using hardware from Pack 1. Side plate of bracket should be facing the outside of cart. Tighten hardware.



STEP 3

Attach factory roof struts using remaining hardware from Pack 1. Re-attach factory roof using retained hardware.

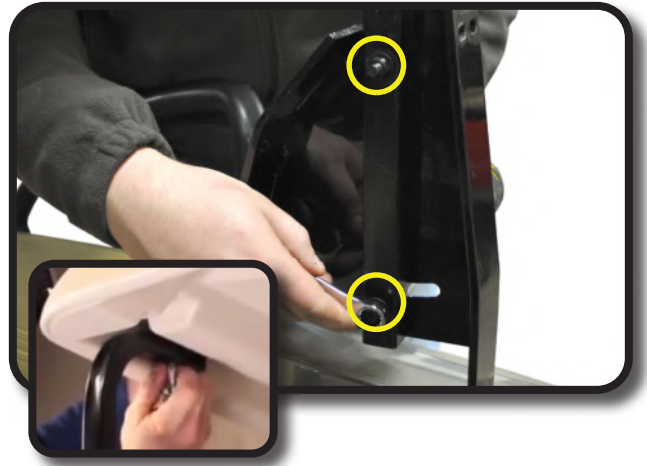

STEP 4

Attach factory lean back cushions using hardware retained from Step 1.

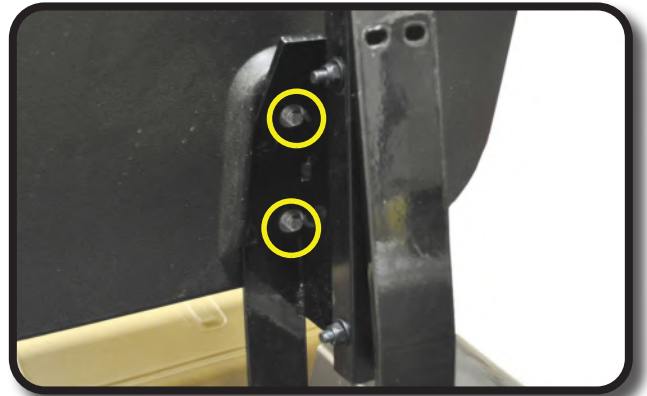

STEP 5

Attach main polyboard frame to main bracket using 8mm Hex head bolts from Pack 2 and tighten.

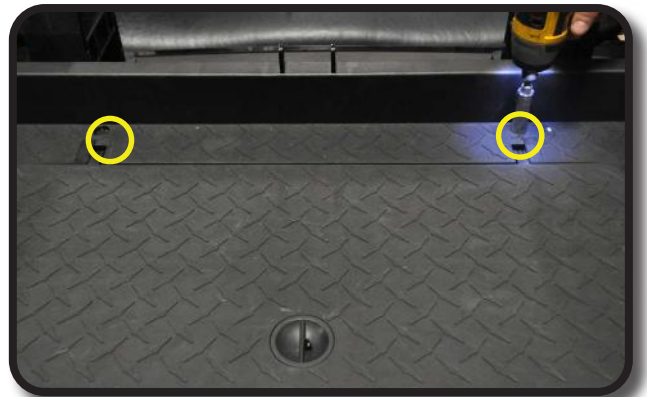

STEP 6

Attach bagwell bracket to poly seat frame as shown using 10mm hex head hardware from Pack 2.

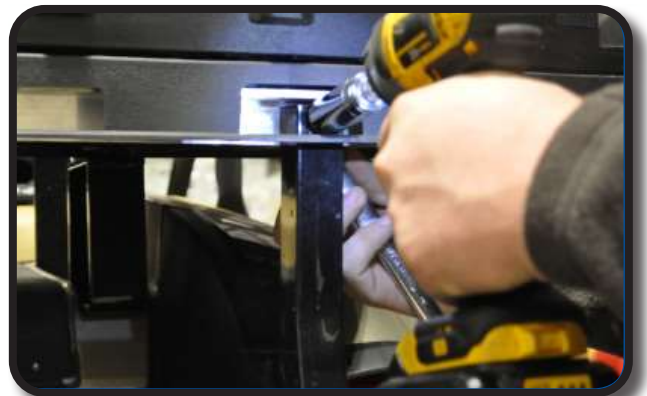

STEP 7

Using a 3/8" drill bit, drill through outer bumper into bagwell.



STEP 8

Attach bagwell bracket to rear of cart as shown using countersunk hardware from Pack 2.

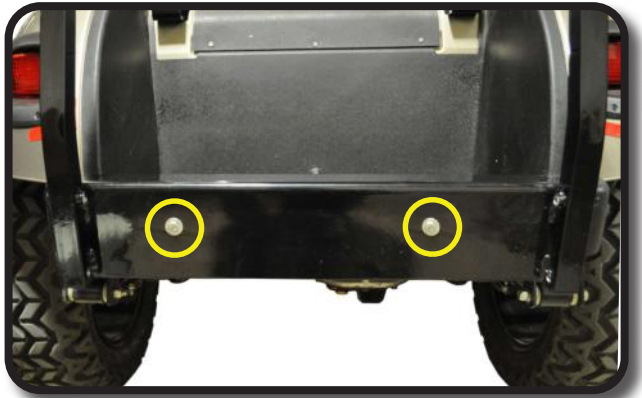

STEP 9

Attach armrest to main polyboard frame using hardware from Pack 3. Repeat process on the other side. Tighten hardware.



STEP 10

If using cushions supplied with this seat kit - Skip this step. Do not install brackets shown in picture.

If installing any custom seat cushions, attach the brackets shown here. Using the appropriate labeled hole for your cart, attach this bracket to main seat bracket using hardware from Pack 5.

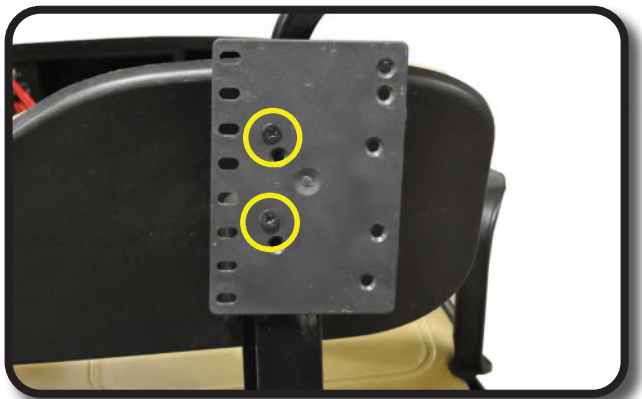

STEP 11

Attach footrest to bagwell bracket using 10mm hardware from Pack 6. Repeat process on other side and tighten. Use quick release clips on bottom rear footplate.



STEP 12

Slide grab bar up from the bottom of the footrest and attach grab bar to foot rest as shown using hardware from Pack 6.

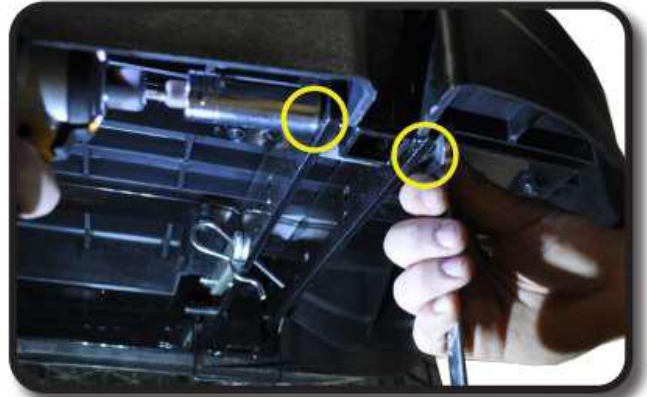

STEP 13

Secure footrest as shown using quick release clips from hardware Pack 6.



STEP 14

Attach seat bottom cushion as shown using hardware from Pack 7.



STEP 15

Footplate can be folded up by removing the four quick release clips and folding forward. To lock footplate in up right position use brackets as shown.



INSTALLATION COMPLETE

E-Z-GO®, E-Z-Go® TXT®, and E-Z-Go® RXV® are registered trademarks of Textron Innovations, Inc. Club Car®, Club Car® Precedent®, and Club Car® DS® are registered trademarks of Ingersoll Rand, Inc. Yamaha®, Yamaha® Drive®, G-14®, G-16®, G-19®, and G-22® are registered trademarks of Yamaha Golf-Car Company. Any reference to Club Car®, E-Z-Go®, or Yamaha® or their associated trademarks, word marks, and products are only for purposes of identifying golf carts with which this product is compatible. These products are aftermarket parts and are not original equipment parts. Excalibur is not connected to, affiliated with, sponsored by, or endorsed by either Textron Innovations, Inc., Ingersoll Rand, Inc., Yamaha Golf Cart Company, or any of their parent or subsidiary companies.

HARDWARE PACK

Pack 1

- 4 – 10x30mm hex bolt
- 4 – 10x20mm flat washer
- 2 – 10mm lock washer
- 12 – Rubber Washers
- 4 – 8x45mm Hex bolts
- 8 – 8x20mm flat washers
- 4 – 8mm lock nuts

Pack 2

- 2 – 8x60mm hex bolt
- 4 – 8x15mm flat washer
- 2 – 8mm lock nut
- 2 – 10x70mm countersunk #3 phillips
- 2 – 10x20mm flat washer
- 2 – 10mm lock nut
- 10 – Rubber Washers
- 2 – 10x50mm Hex bolts
- 4 – 10mm Flat washers
- 4 – 10mm lock nuts

Pack 3

- 4 – 8x30mm hex bolt
- 4 – 8x15mm flat washer

Pack 4

- 4 – 8x30mm countersunk #3 Phillips
- 4 – 8x15mm flat washer
- 4 – 8mm locknut

Pack 5

- 4 – 6x25mm hex bolt
- 4 – 6x15mm flat washer
- 4 – 6mm lock washer

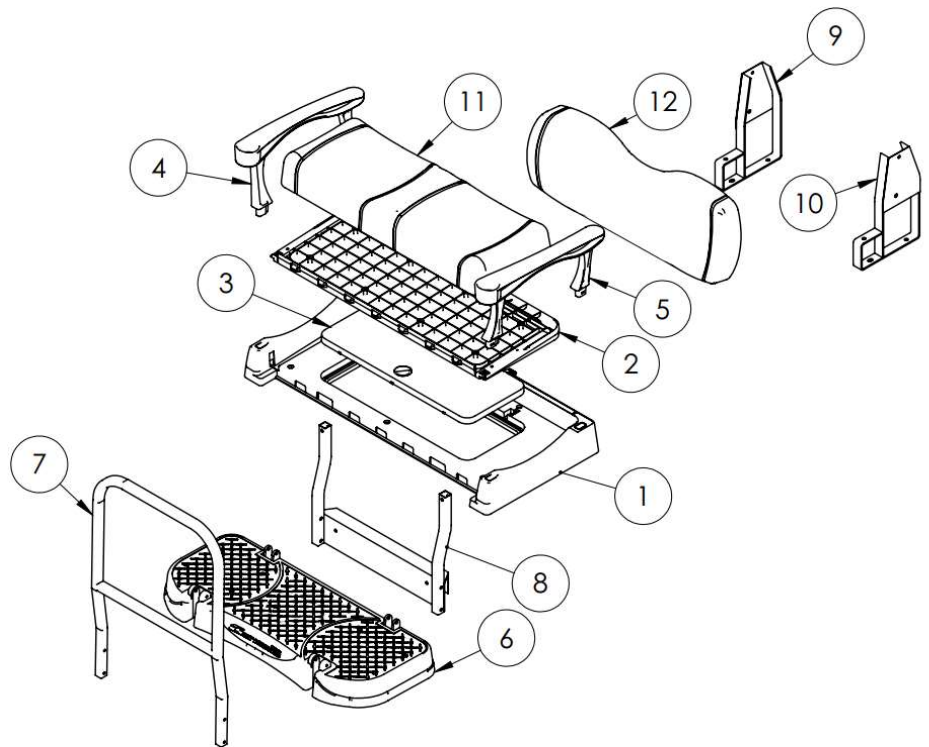

Pack 6

- 4 – 10x75mm hex bolt
- 8 – 10x20mm flat washer
- 4 – 10mm Locknut
- 4 – Quick release pins (easy remove hardware for folding in the foot plate)
- 8 – Rubber Washers

Pack 7

- 8 – 8x40mm countersunk