

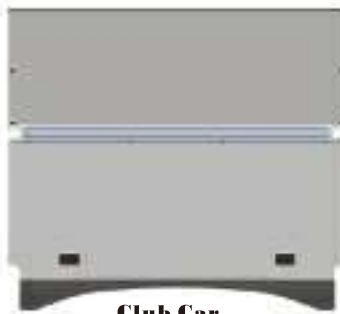

GOLF CART WINDSHIELDS



EZGO TXT



**Club Car
Precedent**



EZGO RXV



Yamaha Drive



Yamaha Drive2



Club Car DS 82-00.5



Club Car DS 00.5-07



Yamaha G14-G19



Yamaha G22

TABLE OF CONTENTS:

Step 1 - Install Lower Extrusion

Step 2 - Install Side Extrusions

Step 3 - Install Windshield

Step 4 - Install Upper Latches

IMPORTANT: Do not fully tighten hardware until instructed.
Read through all instructions before beginning installation.

PREPARE CAR FOR INSTALLATION:

Remove the following:

- Factory Windshield • Rubber Grommets & Hardware (if present)

STEP 1

INSTALL LOWER EXTRUSION

1 MOUNT LOWER EXTRUSION TO WINDSHIELD

Club Car DS / Yamaha G14-G19/Yamaha G22

*Peel protective plastic film away from the windshield and then start to install the Lower and Side Extrusions.

Mount Lower Extrusion to bottom of Windshield using the channel in the Extrusion.

NOTE: Push Lower Extrusion onto Windshield until fully seated.

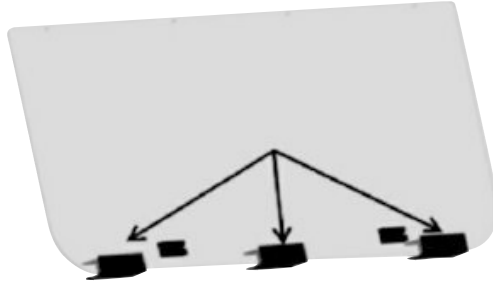

Club Car DS/Yamaha G14-G19/Yamaha G22

STEP 2

INSTALL SIDE EXTRUSIONS

1 MOUNT SIDE EXTRUSIONS TO WINDSHIELD

*Peel protective plastic film away from the windshield and then start to install the Lower and Side Extrusions.

Place Side Extrusions on both sides of Windshield as shown below.

NOTE: Depending on the model, your Windshield will have either 2 Long Side Extrusion Pieces or 4 Shorter ones. In either case, the Extrusions install the same way.

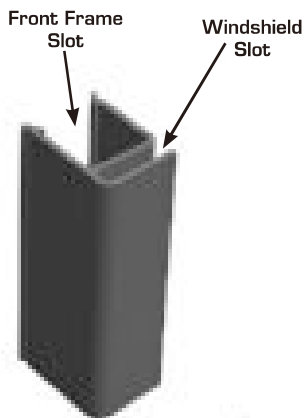

SIDE EXTRUSION

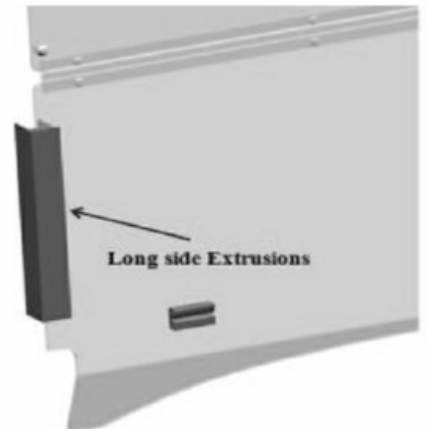
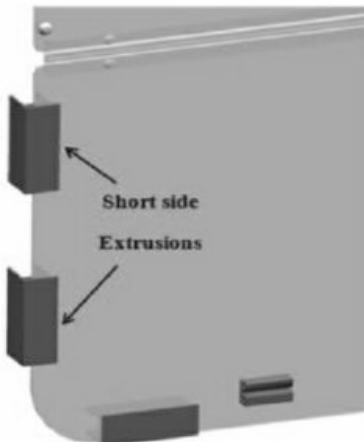

STEP 3

INSTALL WINDSHIELD

1 MOUNT WINDSHIELD TO FRONT FRAME

Club Car Precedent/EZGO TXT/YAMAHA DRIVE/YAMAHA DRIVE2

**Remove the Factory Rubber Grommets, Spacer, and Hardware from the Front Frame.*

Position Windshield and Extrusions over Front Frame and push Extrusions until they clip over Front Frame (B).

Mount Windshield to the Front Frame by clipping Side Extrusions onto the Front Frame. Slide the Windshield down until the notches in the Windshield are resting on Rubber Grommets.

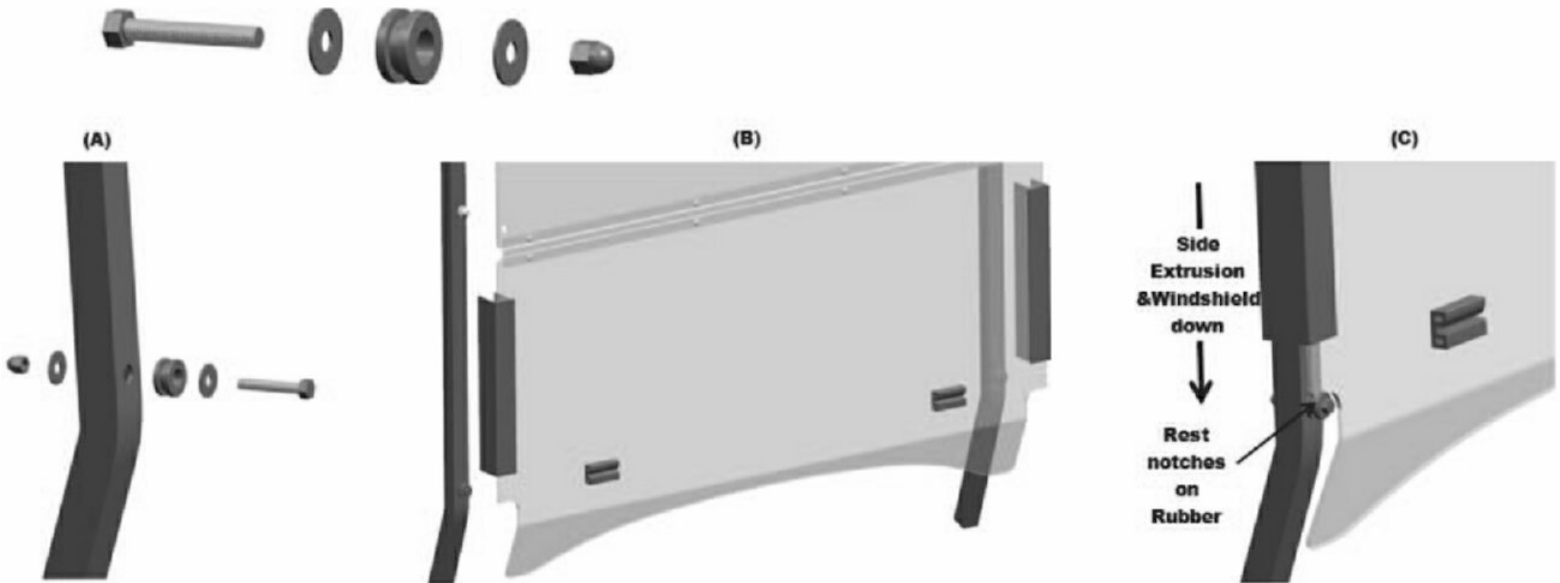

Club Car DS Old/Club Car DS New/Yamaha G14-G19/Yamaha G22/EZGO RXV

Align the Windshield to the Front Frame. The Side and Bottom Extrusions can often be snapped over the Front Frame at the same time. Push in and down at the same time to snap the Extrusions over the Front Frame.

If the Lower Keepers do not fully clip around Front Frame then push Windshield down until they do.

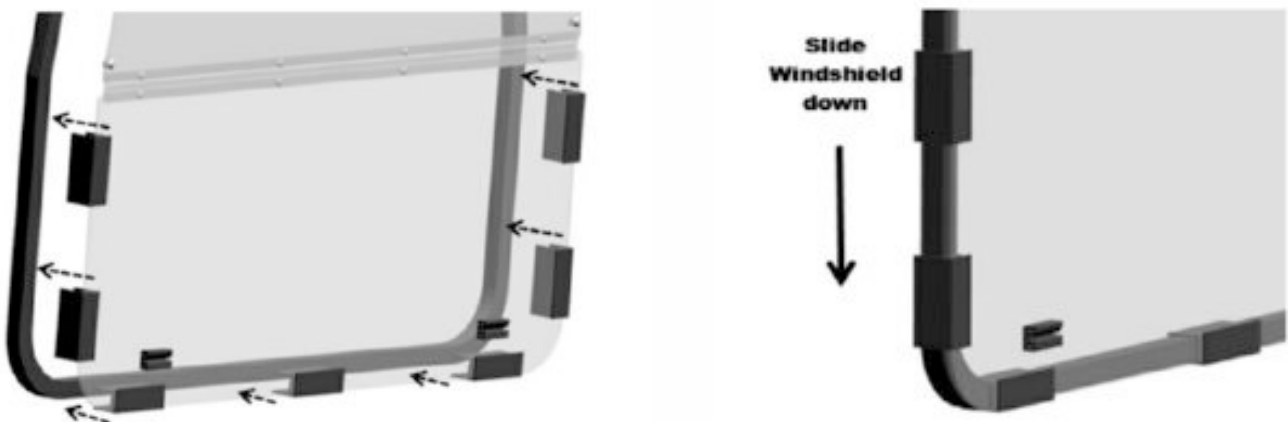

STEP 4

INSTALL UPPER LATCHES

1 MOUNT UPPER LATCHES TO FRONT FRAME

Install the Rubber clip on both side of upper windshield (first make the rubber clip hook mounted and then pull the drill with tool through the circle hole)

Step1

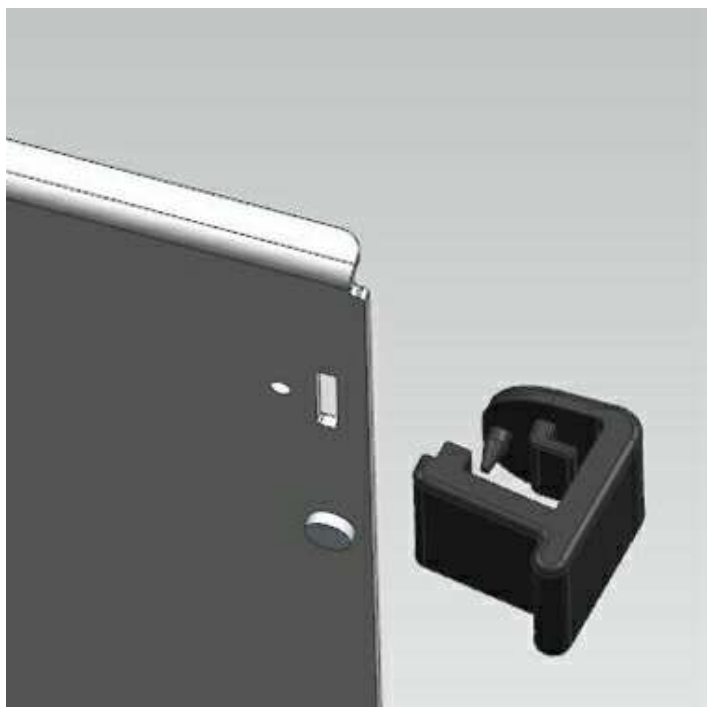

Step2



Step3

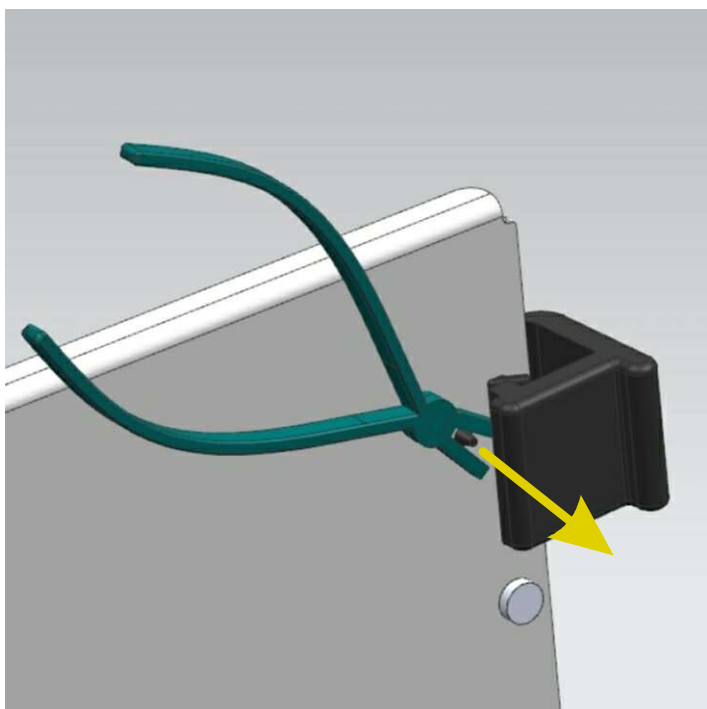

Step4

