

Milly + Coup

Leo

•

**Double Seat Set
Product Manual**

IMPORTANT! READ CAREFULLY
AND KEEP FOR FUTURE REFERENCE

Welcome!

Thanks for choosing Milly + Coup.

We bet you can't wait to meet Leo, but before you do, please ensure you carefully read your manual and all safety information.

Leo complies with both mandatory and voluntary Australian and New Zealand Safety Standards, however if you're not using it correctly or are not aware of the safety features, serious accidents can occur.

Wishing you many fun, happy and safe adventures out and about with Leo!

Contents

- 4.** Safety warnings
- 6.** Parts checklist
- 7.** Setting up your frame
- 8.** Folding the stroller
- 9.** Double or single mode?
- 10.** Configurations
- 11.** Setting up your seats
- 13.** Using the harness
- 14.** Using your Leo
- 14.** Rear brake
- 14.** Adjusting the footrest
- 14.** Adjusting the handlebar
- 15.** Front swivel wheels
- 15.** Rear wheels
- 16.** Free accessories
- 18.** Using Leo with a car capsule
- 19.** Leo maintenance
- 21.** Cleaning instructions
- 22.** Spare parts
- 22.** Warranty

Tips to avoid tears

Leo is designed and tested to comply with Consumer Protection Notice No. 8 of 2007, AS 2088:2022 and AS/NZS ISO 8124-3.

WARNING

- FOLLOW THE MANUFACTURER'S INSTRUCTIONS.
- PUT ON ALL THE BRAKES WHENEVER YOU PARK THE STROLLER.
- DO NOT LEAVE CHILDREN UNATTENDED.
- DO NOT CARRY EXTRA CHILDREN OR BAGS ON THIS STROLLER.
- MAKE SURE CHILDREN ARE CLEAR OF ANY MOVING PARTS IF YOU ADJUST THE STROLLER, OTHERWISE THEY MAY BE INJURED.

Weight limits

- Maximum weight for a child in the seat is 20kg.
- Maximum weight for items in the basket is 12kg.
- Maximum weight that can be hung from the handlebar is 2kg.
- Maximum weight for the toddler board (sold separately) is 20kg.

General safety

- Never use the stroller in a manner for which it is not designed.
- Do not allow your child to climb, stand on or play with the stroller.
- Do not use parts or accessories that are not approved for use with the Leo range. Doing so may be unsafe and may also void your warranty.
- Ensure you carefully explain usage and safety features to new carers before they use the stroller.
- Remove your child and fold the stroller when going up or down stairs or escalators.
- Take your child out of the stroller when travelling by bus, tram, or train.
- Gentle sloping surfaces may be unstable. On steeper sloping and uneven surfaces, there is a possibility that the stroller may tip over and you may need to remove your child.
- Do not use or leave the pram near open fire or an exposed flame.
- Only to be used for walking. Not suitable for running, rollerblading or skating etc.

Tips to avoid tears

Accessories

- The Milly + Coup Toddler Board (sold as a separate accessory) is compatible with Leo.
- Leo is only compatible with select car capsule models using the approved capsule adaptors. Refer to our website for full compatibility.

⚠ WARNING

WHEN USING THE STROLLER WITH ONE CHILD, THE LOWER ADAPTORS MUST NOT BE USED

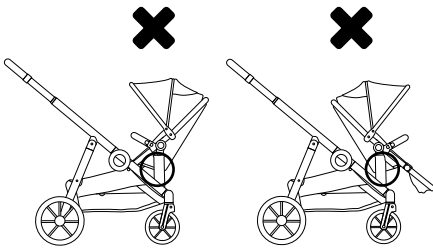

⚠ WARNING

WHEN USING THE FRONT SEAT IN PARENT FACING MODE THE SEAT CANNOT BE RECLINED

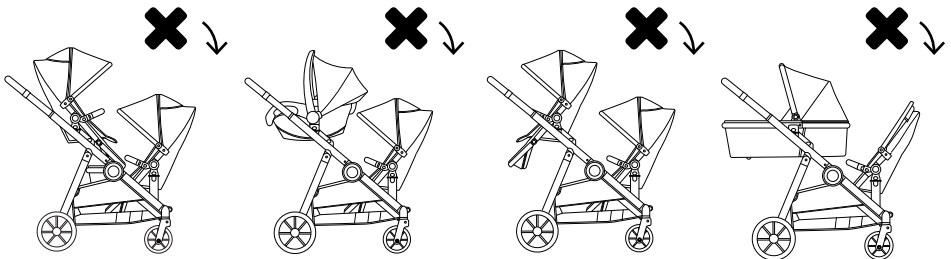

Meet Leo!

Parts Checklist

Please check that you have all the correct parts before getting started.

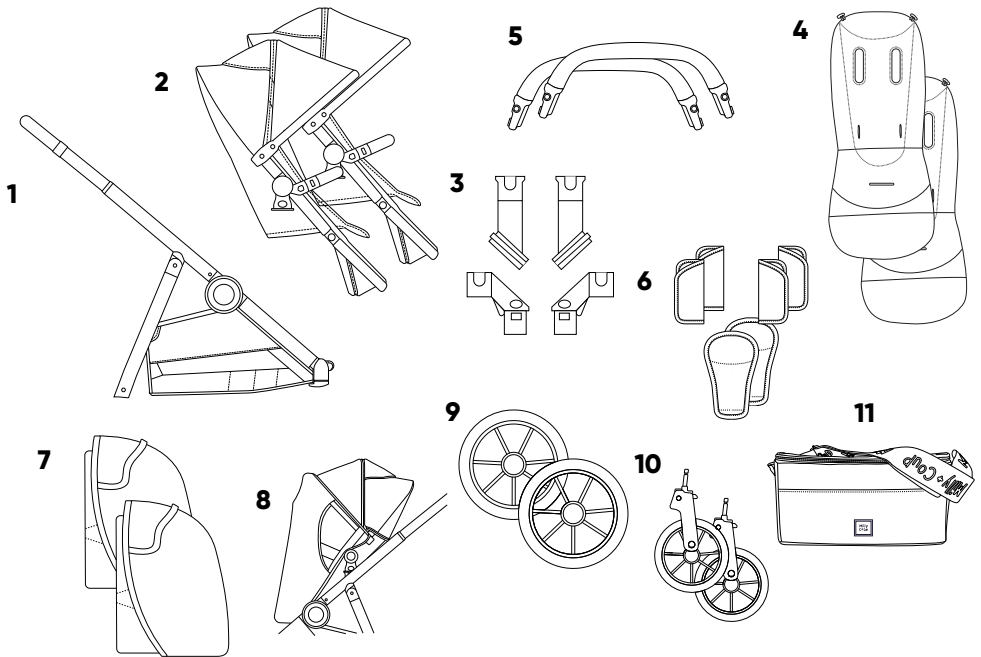

- 1** Stroller frame
- 2** 2 x Stroller seats
- 3** Double adaptors
- 4** 2 x Seat liners
- 5** 2 x Belly bars
- 6** 2 x Harness cover set
- 7** 2 x Rain covers
- 8** 2 x UV cover (located in seat footrest pocket)
- 9** 2 x Rear wheels
- 10** 2 x Front wheels
- 11** Handlebar bag

Setting up your frame

- + To open the frame, release the frame lock.

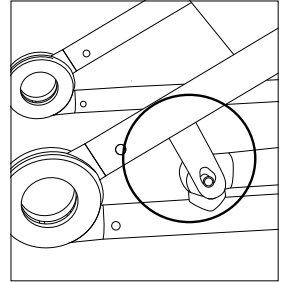

- + Lift the handlebar upwards until you hear the frame 'click' into place.

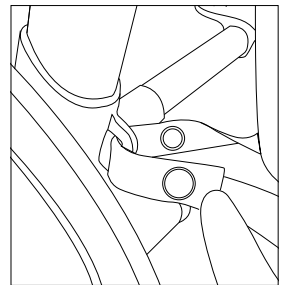

- + Thread the basket tab through the slot behind the rear wheel hub and secure the press stud. Repeat for the other side.

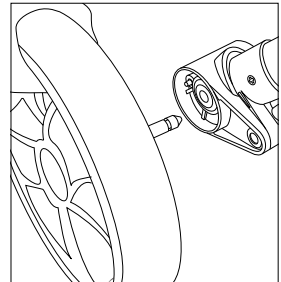

- + Insert each rear wheel pin into the sides of the brake bar until you hear a 'click'. Give them a tug to ensure they are attached securely.

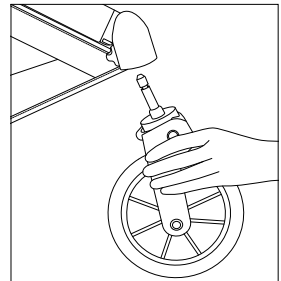

- + Insert the front wheels into the centre of the socket ensuring you hear them 'click' in.

Folding the stroller

- +** Before folding, ensure that the brake is engaged, the front wheels are unlocked, and the handlebar is at the lowest height position.
- +** Remove the second seat, bassinet, or capsule by lifting the release levers on either side (the stroller can be folded with one seat in the forward facing position only.)
- +** Standing at the front of the stroller, slide the black buttons located on the black circular handles and the frame will fold in half.
- +** Ensure the automatic frame lock has engaged on the side of the stroller before lifting the frame up using the circular handles.

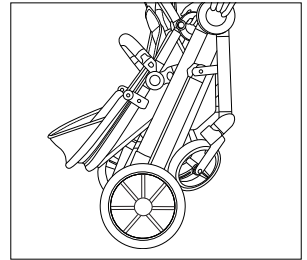
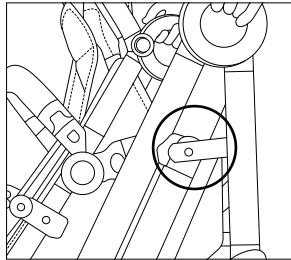
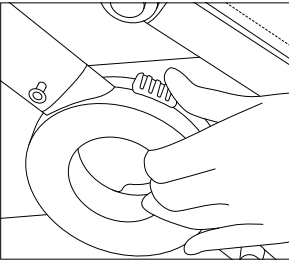

! WARNING

- ENSURE CHILDREN ARE OUT OF REACH OF THE STROLLER BEFORE FOLDING.
- TAKE EXTRA CARE WHEN FOLDING, LIFTING AND CARRYING THE STROLLER. ALWAYS LIFT AND CARRY YOUR STROLLER USING BOTH HANDS.
- TO AVOID POSSIBLE INJURY, ALWAYS ENSURE THAT THE FRAME LOCK IS SECURED BEFORE LIFTING AND CARRYING THE STROLLER.
- TO AVOID FINGER ENTRAPMENT, KEEP YOUR OWN AND YOUR CHILDREN'S FINGERS CLEAR OF ANY FOLDING PARTS.
- ALWAYS REMOVE THE BASSINET, SECOND SEAT OR CAR CAPSULE PRIOR TO FOLDING AND CARRY THE FRAME AND BASSINET/SEAT/CAR CAPSULE SEPARATELY. ONLY LIFT AND CARRY AFTER FOLDING.

Double or single mode?



Single Mode

When using the stroller in single mode, the lower adaptors **must not be used**. The upper adaptors can however be used. The bassinet or seat can be attached directly into the upper adaptors or into the central connectors on the frame.

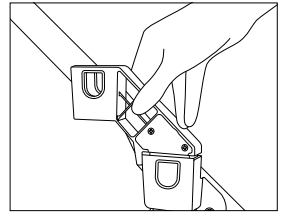

Upper adaptors



Double Mode

Attach the two sets of double adaptors. The upper adaptors attach into the central connectors for the "top position". To remove them simply push the buttons on the side and lift off.

The lower adaptors will slide onto the guides at the front of the frame for the "lower position". To remove them you will need to release the tab at the top of the connector before sliding off.

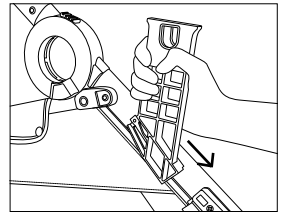

Lower adaptors

WARNING

THERE IS AN INCREASED RISK OF THE STROLLER TIPPING IF USED IN DOUBLE MODE WITH ONLY ONE CHILD IN THE SEAT. PLEASE BE MINDFUL OF THIS AND HOLD THE STROLLER AT ALL TIMES IF YOU ARE DOING SO.

Configurations

Single mode:

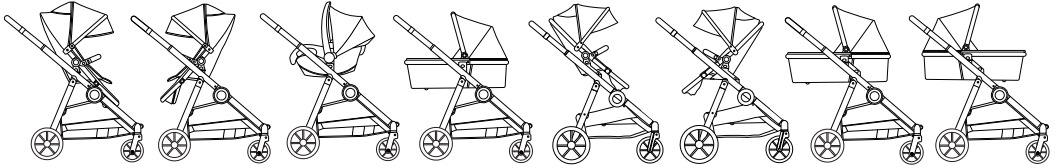

Two seats:

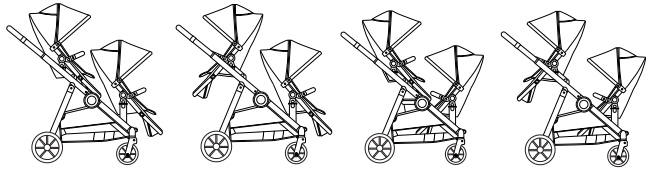

You can purchase an additional bassinet, or capsule adaptors on our website to enable the following configurations.

Seat + bassinet:



Two bassinets:

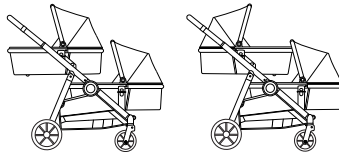

Car Capsules:

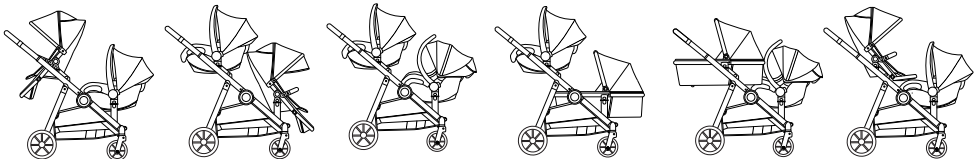

Setting up your seats



Line up the seat connectors with the frame and press downwards. Listen for the 'click' to ensure it is securely locked in place.

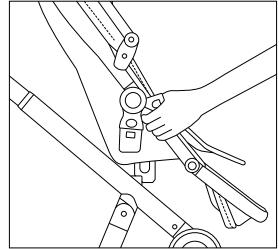

Attach the plastic canopy connectors onto the sides of the seat frame (**TIP:** attach from top to bottom). You'll notice a round guide on each side, the connectors should attach over these guides.

Note: For additional headroom you can attach the canopy connectors higher up on the frame above the guides.

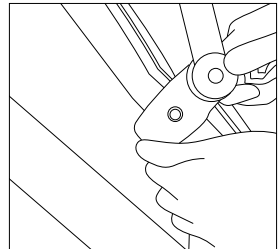
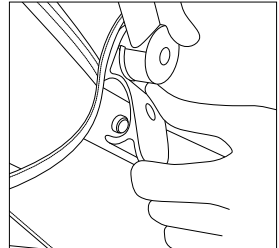

Insert the belly bar into the belly bar sockets on the seat frame. Always give the bar a firm tug to ensure its secure.

Note: To remove from one side or both, press the button on the side you want to release, and pull the belly bar out.

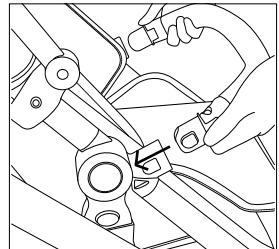

Setting up your seats



To recline the seat: press the large, round buttons on the sides of the seat connectors and tilt the seat forward or back.

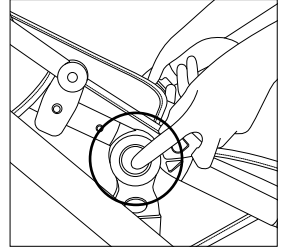

To remove the seat: press the oval buttons on the sides of the seat connectors and lift up.

Note: the seat can be faced in the forward or rear facing position.

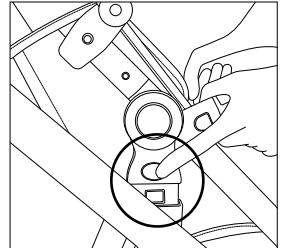

WARNING

- THIS STROLLER SEATS TWO PASSENGERS WITH A MAXIMUM WEIGHT LIMIT OF 20KG EACH.
- THE STROLLER SEATS ARE NOT RECOMMENDED FOR CHILDREN UNDER 6 MONTHS.
- DO NOT ALLOW YOUR CHILD TO CLIMB UNASSISTED INTO THE STROLLER.
- DO NOT USE THIS SEAT WITH ANY OTHER MODELS OF STROLLER.

Using the harness



To secure and release the harness

Insert each of the four harness straps into the central buckle.

To release, press the button in the middle of the buckle.

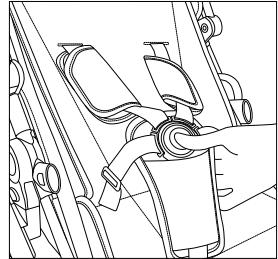

To adjust the length of the shoulder straps

Slide the buckle along the strap to the desired position.

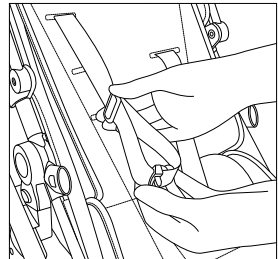

To adjust the height of the shoulder straps

Slide the buckle that is secured to the seat back up or down the strap to the desired position for your child.

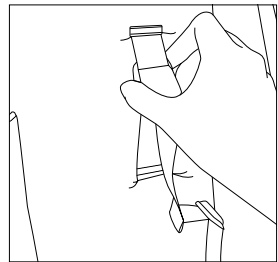

To adjust the length of the waist straps

Pull the adjustor buckle along the waist strap to the desired length.

WARNING

- USE THE HARNESS AT ALL TIMES.
- ENSURE THAT YOUR CHILD CORRECTLY WEARS THE FITTED AND ADJUSTED SAFETY HARNESS AT ALL TIMES WITH ALL 5 STRAPS SECURED.
- NEVER LEAVE THE HARNESS BUCKLED WHEN NOT FITTED TO A CHILD IN THE STROLLER BECAUSE THE HARNESS CAN FORM LOOPS WHICH MAY POSE A STRANGULATION HAZARD.

Using your Leo

Rear brake



When stopped, use the brake at all times by pressing down on the bottom of the red brake paddle with your foot until you feel it click into place.

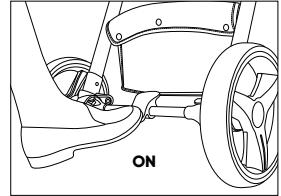

To start travelling again press down on the top of the red brake paddle with your foot to disengage the brake and off you go!

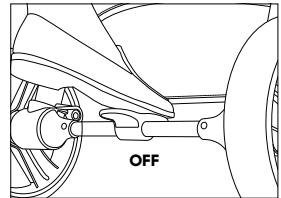

Adjusting the footrest



Lift the foot rest and it will click into the highest position. To release, press both footrest buttons simultaneously and lower.

Note: Do not put downward pressure on the footrest until the buttons are completely depressed or it will feel stuck and not move.

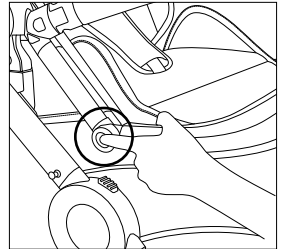

WARNING

NEVER LET CHILDREN SIT ON THE FOOTREST OR CLIMB INTO THE SEAT USING THE FOOTREST. DOING SO MAY SNAP OR DAMAGE THE FOOTREST AND IS NOT COVERED BY YOUR WARRANTY.

Adjusting the handlebar



Push the button in the middle of the handlebar and pull or push to your desired height. It may require a slight 'jiggle' to adjust.

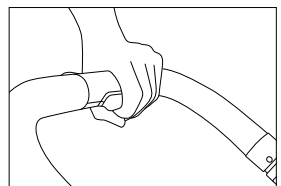

Using your Leo

Front swivel wheels

When travelling quickly along straight surfaces or across uneven terrain, the front wheels may spin or cause what's commonly known as "wheel shudder".

- + To lock the front wheels into place, press down on the wheel lock buttons (located on the back of the wheel sockets). To go back to 360 swivel mode, press the buttons up again.

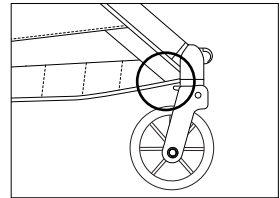

- + To remove the wheels, you will need to use a flat screw driver or similar tool to carefully press in the silver button located on the wheel hub. Please take care whilst doing this.

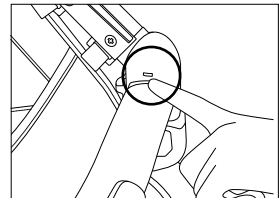

Rear wheels

- + To remove the rear wheels, press the button located on the brake bar and pull the wheel off.

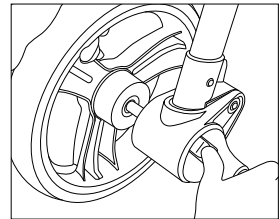

⚠ WARNING

- USE THE TETHER STRAP TO STOP THE STROLLER ROLLING AWAY.
- DO NOT HANG ANY OTHER BAGS OTHER THAN THE LEO HANDLEBAR BAG FROM THE HANDLEBAR. DOING SO MAY UNBALANCE AND TIP YOUR STROLLER.
- THE LEO HANDLEBAR BAG HAS BEEN TESTED TO HOLD 2KG.
- BE CAREFUL CARRYING LIQUIDS IN THE HANDLEBAR BAG. HOT LIQUIDS MAY BURN YOU OR YOUR CHILD.

Free accessories

Rain covers

- + The rain covers are compatible with both the seat and bassinet. Place them over the top of the seat or bassinet. The open flap should be at the top, this is to access the bassinet handle.

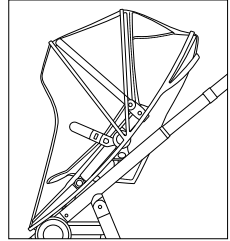
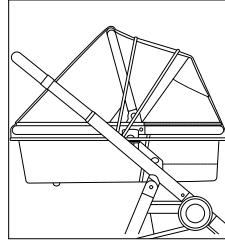

UV/Sleep/Mosquito Cover

- + There are two UV covers included with your Leo – one for the seat and one for the bassinet.
- + The seat UV cover is located in the zipper pocket underneath the seat foot rest.
- + The bassinet UV cover is located in a pocket inside the foot end of the bassinet.
- + **For the seat:** Place it over the seat canopy and attach the elastic to the back of the canopy connectors and then tuck under the footrest.

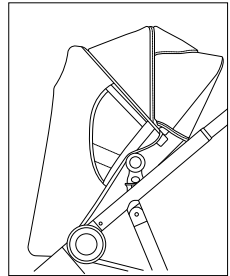

WARNING

- NEVER LEAVE THE STROLLER COVERED INDOORS, IN VERY HOT WEATHER OR NEAR A HEAT SOURCE.
- ALWAYS SUPERVISE AND MONITOR YOUR CHILD REGULARLY WHILE THE STROLLER IS COVERED.

Free accessories

UV/Sleep/Mosquito Cover cont.

- +** **For the bassinet:** Attach the toggles to the loop fixing points on the inside of the bassinet canopy. Pull the elastic end over the foot end of the bassinet and secure the tabs on each side of the UV cover underneath the frame tube of the bassinet.

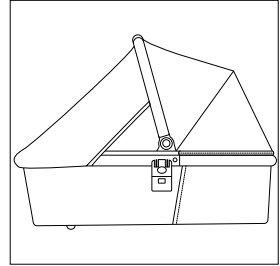

Handlebar Bag

- +** Adjust the strap of the handlebar bag to the desired length and slip over the handlebar.
- +** Position the bag behind the hooks on either side of the handlebar to keep it in place.

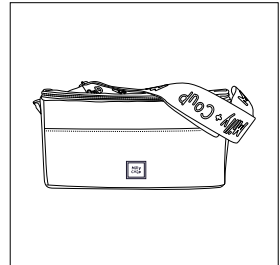

Seat Liner

- +** Attach the seat liner by threading the harness straps from the seat through the corresponding slot.
- +** Secure the seat liner to the seat by threading the plastic toggles through the slots in the top of the seat and secure through the elastic loops.

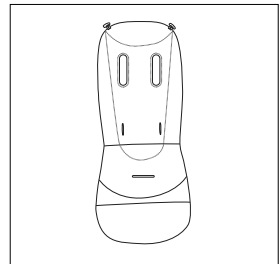

Using Leo with a car capsule

The following car capsules are compatible with the DUO3 Capsule Adaptors (sold separately). The list of compatible car capsules changes regularly as new capsule models are released or older versions are updated and launched to market. Please refer to our website for the most up to date compatibility list.

Please ensure you choose the correct capsule adaptors to fit your pram.

- | | | |
|--------------------------------------|--------------------------------|---|
| • Maxi Cosi Citi* | • Joie i-Gemm Signature | * With adaptors purchased after 14/1/2022 |
| • Maxi Cosi Mico Plus | • Cybex Cloud Q | ** Manufactured in 2014 or later |
| • Maxi Cosi Mico 6 | • Nuna Pipa Klik | *** Manufactured in 2013 or later |
| • Maxi Cosi Mico AP** | • Nuna KLIK Plus | **** From manufacture date 18/04/2023 |
| • Maxi Cosi Mico*** | • Bugaboo Turtle by Nuna | |
| • Maxi Cosi Mico 12 / Mico 12 LX**** | • Mother's Choice Baby Capsule | |
| • Joie Gemm | • Britax B-Pod | |
| • Joie i-Gemm | • Britax B-Pod Lite | |

To attach your capsule:

1. Apply the brake before attaching the adaptors to the corresponding connector points on both sides of the stroller frame.
2. Lift your capsule and carefully lower it onto the adaptors until you hear a click. This indicates your capsule is now secured to your stroller.

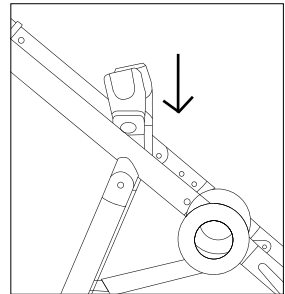

To remove your capsule:

1. Apply the brake then simultaneously press the release buttons on each side **of the capsule** and lift the capsule off the adaptors.

Note: Each capsule mentioned above will have slightly different buttons to release the car capsule from the adaptors.

2. To remove the adaptors from the stroller frame, push the release buttons on either side.

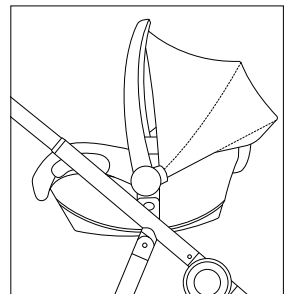

Using Leo with a car capsule

⚠ WARNING

- FOLLOW THE CAR CAPSULE MANUFACTURER'S INSTRUCTIONS CAREFULLY TO PREVENT INJURY OR EVEN DEATH.
- READ CAPSULE MANUFACTURER'S MAXIMUM USAGE TIME RECOMMENDED FOR BABY TO REMAIN IN YOUR SPECIFIC CAPSULE.
- DO NOT USE ANY CAPSULE NOT AUTHORISED BY MILLY + COUP.
- ENSURE ALL FINGERS AND BODY PARTS ARE CLEAR OF THE CAPSULE AND STROLLER FRAME WHEN ATTACHING.
- NEVER PLACE THE CAR CAPSULE IN THE CAR WHILE ADAPTORS ARE ATTACHED.

Leo maintenance

Excessive wear can reduce the effectiveness and safety of your stroller. Please be gentle, don't overload it, avoid excessive off-road use and be sure to follow the maintenance instructions below to keep your stroller looking and feeling newer for longer!

Regular maintenance:

- Inspect the locking devices, levers, joints, buttons, brakes, wheels, safety harness and fixtures to ensure they are secure, moving freely and in fully working order.
- If your front wheels or any parts of the stroller have become stiff, difficult to operate or begin to squeak, first ensure that dirt is not the cause and give them a good clean with a damp (not wet) cloth. Then try a light application

Leo maintenance

of a sprayable silicone lubricant, ensuring that it penetrates between the components.

WARNING

**POISONOUS, TOXIC SUBSTANCE.
USE WITH CARE.**

- ENSURE CHILDREN ARE NOT PRESENT WHEN APPLYING SILICONE LUBRICANT OR ALLOWING IT TO DRY.
- ALWAYS SPRAY OUTSIDE OR IN A WELL-VENTILATED AREA.
- ENSURE YOU USE MINIMAL PRODUCT AND WIPE AWAY EXCESS SOLUTION BEFORE USE.

Correct storage:

- Do not leave the stroller in direct sunlight for prolonged periods of time to avoid colour fade.
- Do not leave the stroller in your car on hot days or near any heat source or fire.
- Do not store the stroller with heavy items on top of it.
- Store the stroller in a dry, well-ventilated, and safe place.

Preventing rust and mould:

After exposure to wet or damp conditions (especially trips to the beach, snow or in the rain), leave the stroller fully open in a warm, well ventilated environment to prevent rust and mould.

You may need to dry the stroller with a soft, lint free cloth. Left damp it will encourage mildew, mould or rust to form causing damage.

Try to store your stroller in a dry, well-ventilated room inside your house. Ventilation is key.

Note: mould is an environmental issue caused by excess moisture in the air. If you live in a humid climate, please keep this in mind and take extra care to prevent mould.

Cleaning instructions

To keep your stroller looking and functioning like new, we recommend a deep, comprehensive clean every 6 months.

Refer to the cre labels on your stroller. For a full guide on how to clean your pram, please refer to our website.

DO NOT

- Do not immerse the seat or canopy in water, sponge clean only.
- Do not clean with abrasive materials or use ammonia, bleach, solvents, caustic or spirit-based cleaners.
- Do not press or iron.
- Do not rub or wring fabric.
- Do not tumble dry.
- Do not dry clean.

Tips to avoid tears

- Do not clean your stroller with children around.
- Do not remove, dismantle, or alter any part of the folding mechanisms, frame, brake axle or wheels for cleaning or any other reason.
- Do not use if any part is broken, torn, or missing. Replacement parts are available from our website or by contacting us.

Failing to adhere to these maintenance and cleaning instructions could damage or affect the safety of your stroller and may void your warranty.

Spare parts

The wheels are subject to normal wear and tear and should be replaced if necessary.

Spare parts are available for purchase on the Accessories and Spare Parts page of our website (millyandcoup.com). If the part you require is not listed, please email us for a quote at:

au.support@millyandcoup.com or **nz.support@millyandcoup.com**

Warranty

Leo comes with a 3 year defects warranty to cover against faults in materials and workmanship when your stroller is used under normal conditions, according to our user manual and technical specifications.

Our goods come with guarantees that cannot be excluded under the Consumer Law in the country of purchase. You are entitled to a replacement or refund for a major failure and for compensation for any other reasonably foreseeable loss or damage. You are also entitled to have the goods repaired or replaced if the goods fail to be of acceptable quality and the failure does not amount to a major failure.

For full warranty terms and conditions or to make a claim, please visit the Warranty page of our website for details.

**Get ready to
rock 'n stroll!**



Contact Us:

au.support@millyandcoup.com | nz.support@millyandcoup.com

Model: Leo **Version:** 17 Jan 2024

Information subject to change. Please see website for current version.

millyandcoup.com