

QuickDraw

Quick Draw Numbering System operating instructions for new red masterframes.

Thank you for purchasing our second generation Quick Draw Numbering System. It is a very affordable and easy to use system for printing athletic numbers.

Our new generation system offers many new advantages over our old system. The master frame is powder coated for easy clean-up. It is locked into your press exactly the same as if it were a standard silkscreen. The 3" wide bottom of the red master frame is what is locked into the clamp of your backclamp press, or on the bottom end of your sideclamps if you have a sideclamp press. If you have a side clamp press it will be inserted using the side bars in the same way as a regular screen. Make sure that the pins are facing upwards. We have inserted 11 stainless steel allen head pins along the top and also the bottom of the frame. Of the 11 pins one is in the middle. It has no number printed under it. All the other pins have white numbers printed under them. The middle pin is the pin that the small number screens drop into when you are printing a jersey with a single digit number.

The system has off-contact built into it. The small screen when positioned properly in the master frame will have an off-contact of 3/16". It is very important to make sure that the shirtboards are parallel with the master frame when it is in the down position. Ideally the master frame should contact the top and bottom of the shirtboard when in the print position. By allowing it to rest on the shirtboard you will insure perfect off-contact during the printing process.

Each small numbering screen has two aluminum tabs welded onto either end. One has an oblong hole and the other has a perfectly round hole. The screen should be burned with the oblong hole at the bottom of the burned number. That way the screen can easily be inserted into the master frame. You will find that inserting the oblong hole first and the round hole second will make it easier to lock the small screen into place. By following this procedure the number will automatically be positioned exactly in the middle of the jersey, as long as the shirtboard is centered to the masterframe and the garment is centered on the shirtboard. All of the other pins have numbers printed under them. Those numbers refer to height of the number that you are printing. There are "4", "6", "8", "10", and "12" pins. The "4" pins are for printing 4" high numbers, the "6" pins are for 6" numbers, etc. Thus, if you wish to print the number 86, for example, using 4" high numbers you would first insert the pre-burned number 8 screen on the right side "4" pins. Print the number, remove the number 8 screen, flash the printed "8" digit, and then insert the number 6 screen in the left side "4" pins. Print the number 6 and then remove the "6" screen. The garment can now be removed and passed through a tunnel dryer to fully cure the ink.

When printing double color numbers you first print the solid number in its proper position, then flash dry the garment. Then insert the outline number into the same pins that you used for the solid number. It will line up perfectly in registration with the base number already printed. There is a built in trap of 1/8". We recommend flashing between colors to avoid ink contamination when printing double color numbers.

The common challenge that all number prints need to address is printing the digit "1". It is a long, narrow number, whereas all the other numbers are the wider and all the same width. If you are printing the digit "1" by itself simply use the center pins of the master frame. When you are printing a double digit number where one of the digits is the number "1" and the other number isn't, such as in the number "81" or "18" you need to adjust placement of the companion number screen in order

QUICKDRAW

to narrow the space between the two numbers. Without doing so the gap between the two numbers is excessive. The way to correct the gap is to simply place the "1" digit screen in its proper pins. Its companion number needs to be adjusted on space closer to the middle of the master frame. For example, if you are printing 8" high numbers and want to print the number "61" place the number 1 screen in its proper 8" pins, however place the number 6 screen in the 6" pins rather than the 8" pins. Just remember, always cheat the companion digit screen on space closer to the center of the master frame, whether it is to the left or right. Following this technique will insure that the number is always centered properly on the jersey. When printing the double digit "11" cheat each digit one space toward the center of the frame, which will narrow the gap even further.

We are often asked if it is necessary to flash between numbers when printing double digit or double color numbers. We always advise our customers to flash between numbers or colors, as it will guarantee that the screens will stay free of unwanted ink on the backside and also the ink will not smear. We do, however, print double digit numbers in trade shows without flashing. In order to do so you must make sure that the off contact on your press is set at a minimum of 3/16" and that care is taken to avoid excess squeegee pressure. As you become more familiar with the feel of the screens you may want to try printing without flashing on some test pellons to see if your equipment and expertise will allow you to do so.

Our small number screens are stretched with 110-White mesh. It is a very durable mesh that will lay down a heavy ink deposit. We recommend using a good dual cure emulsion when exposing the screens, and we recommend hardening off the screen in your exposure unit a second time after the screen has been exposed and rinsed out to make sure the stencil is as hard as possible. We also recommend thorough cleaning and de-inking of the screens after each job to prevent ghost images from building up in the screens.

If you ever damage the mesh on a screen we will be happy to restretch it for you. The restretching cost is \$15.00 per screen and you will be responsible for the freight charges to and from the factory.

Please visit our website at [www.quickdraw.com](#) to learn more about how to properly expose the screens. You will find step by step instructions with color photographs to assist you in preparing the screens for printing. You will also find helpful suggestions and techniques on how to benefit most from the system.

Please feel free to call us at 800-574-3477 if we can be of further help. Happy Printing!



Kevin Hartman
President

QuickDraw

Oblong Hole

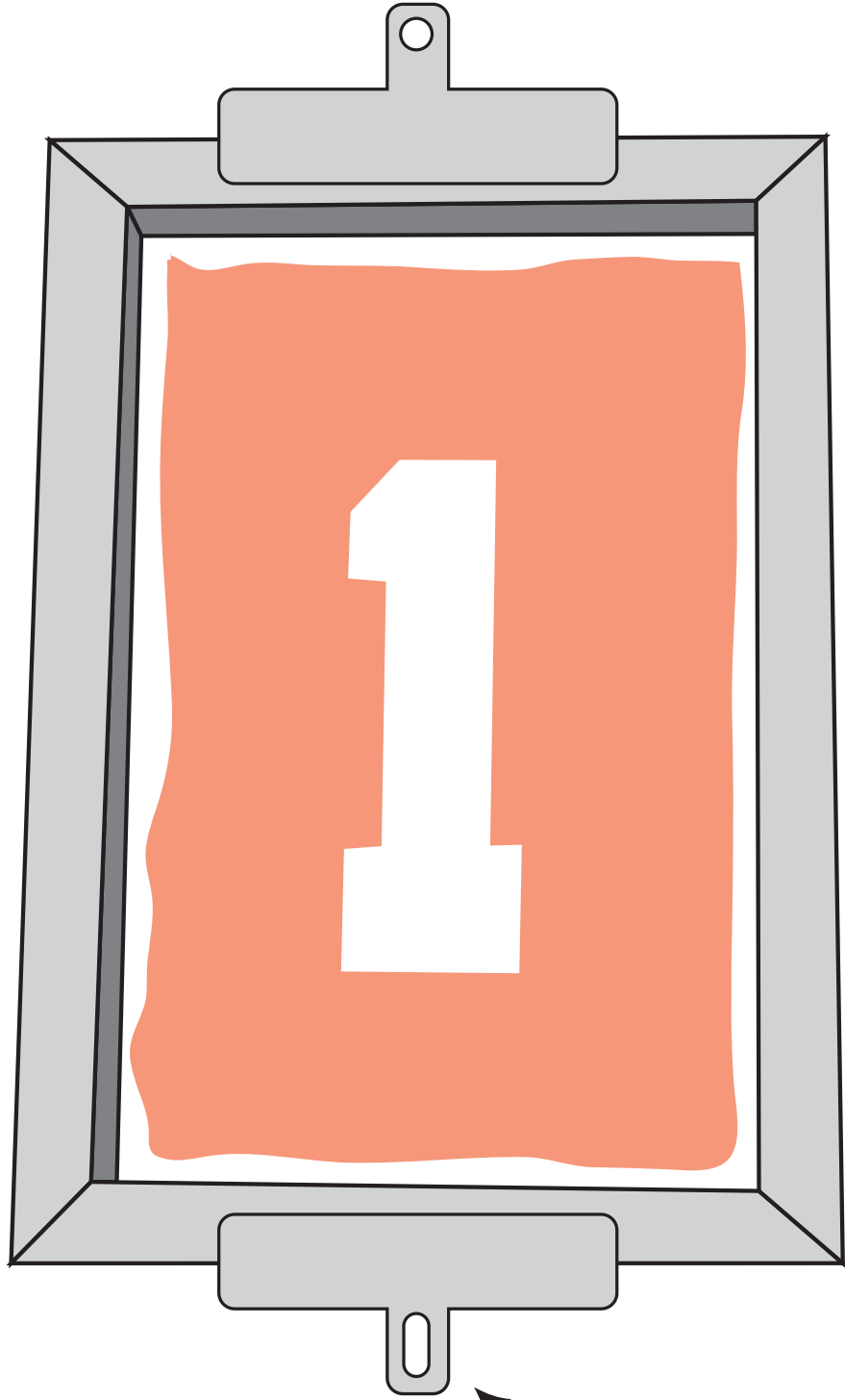

Note that the Oblong hole is the bottom of each number.

QUICKDRAW

Screen Prep

STEP 1 - DEGREASE

Degrease your number screens using Franmar® degrease, and scrub pad. Rinse screens, and let them completely dry. Repeat for all screens.

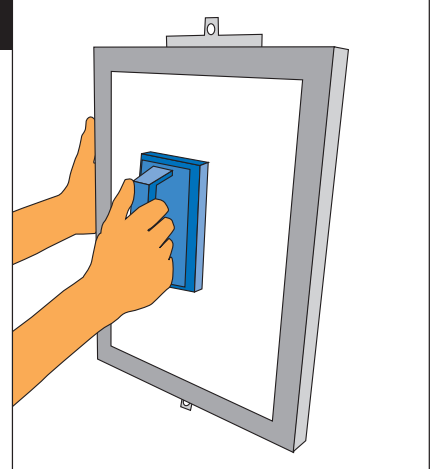

STEP 2 - EMULSION

Once the number screens are dry, coat them with a suitable emulsion for your application. Let the emulsion completely dry. Repeat for all screens.

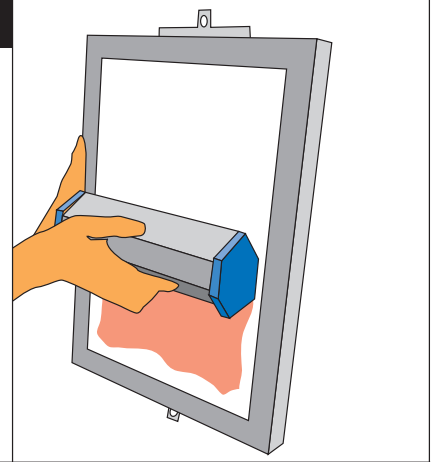

STEP 3 - FILM

Once the emulsion is dry, use a t-square to mark the centers of the back side of the frames both on top and bottom. Then align the vertical marks on the film with the marks on the frame, and the horizontal marks with the inside edge of the frame. Now all screens will be registered.

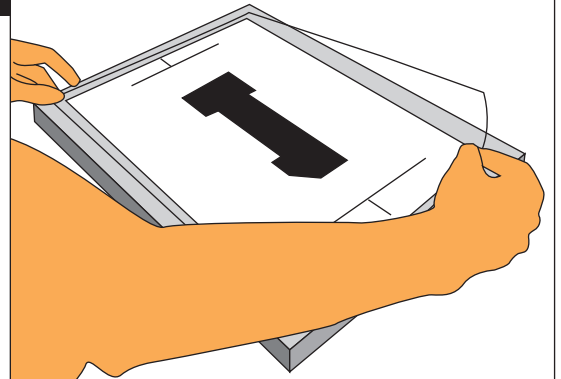

STEP 4 - EXPOSE

When you are ready to expose your screens place them in the exposure unit (you might be able to fit 2 at a time) place the wood blocks provided under the two tab on the screen, this is to prevent tearing of the exposure blanket.

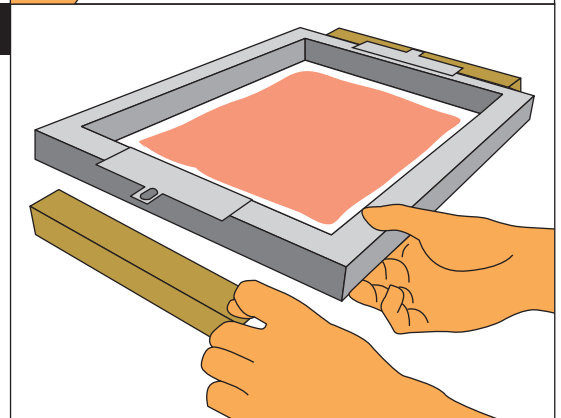

QUICKDRAW

Screen Prep Cont.

STEP 4 - WASHOUT

Once you you have exposed your screens you will need to wash them out, then let them completely dry. After your screens are dry you can re-expose them to completely harden the emulsion. Repeat for all screens.

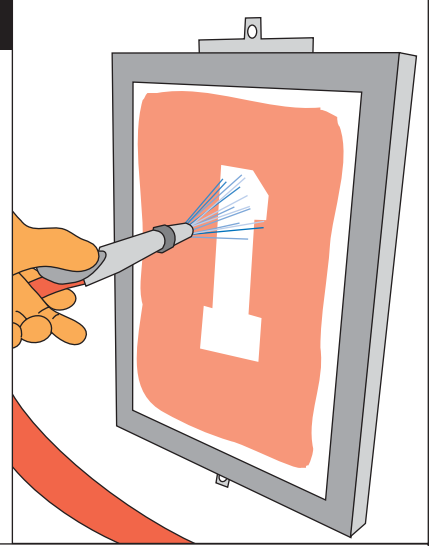

STEP 5 - BLOCK OUT

Now inspect all the screens for pin holes using a light table and a loupe. Block out as necessary. Repeat for all screens.

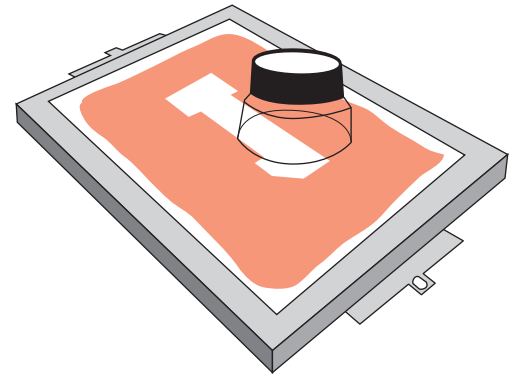

STEP 6 - TAPE

Now is also a good time to tape up the inside corners of the screens. This prevents ink for getting into the corners which can make cleaning up much harder. Repeat for all screens.

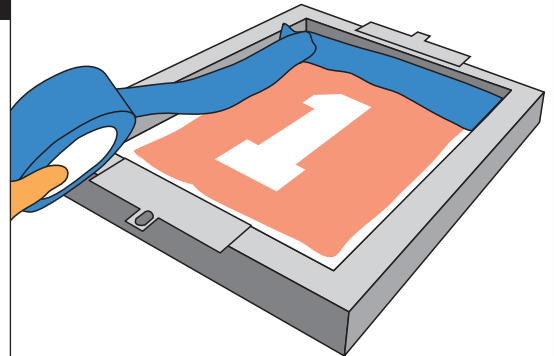

STEP 7 - FINISHED

Now your Number Screens are ready for printing! They can be safely stored in the storage cabinet provided.



QuickDraw

Press Setup

STEP 1 - MOUNT FRAME

Begin by mounting your **QuickDraw** Master Frame onto your press arm. Mount it like you would any other silkscreen frame. For rear clamping presses we recommend using our 27" wide master frame. For side clamp press we have 25" and 23" wide master frames available.

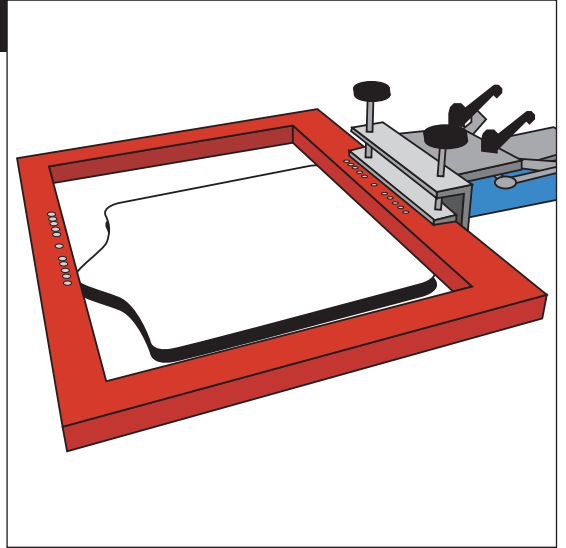

STEP 2 - OFF CONTACT

To set the off contact adjust your press arm so when in the print mode the bottom of the master frame touches the top of your shirtboard. We recommend using a shirtboard that is at least 20" long. Once this is done the off contact is built into the thickness of the Number screens.

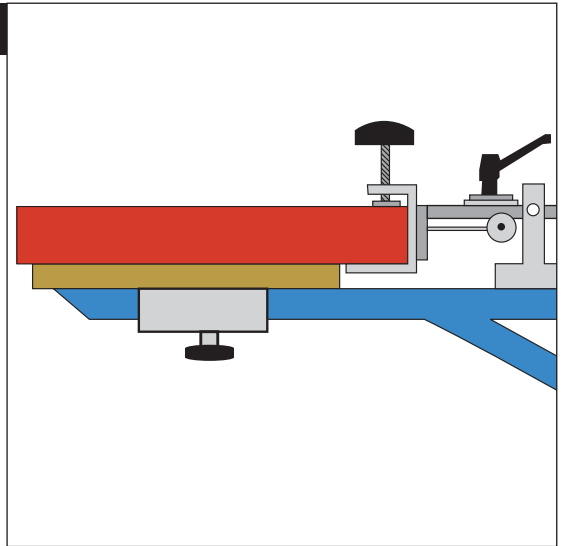

STEP 3 - CENTER

Now that the off contact has been set you need to register the center pins of the master frame to the center line of your platen. Now your ready to drop in your number screens and start printing fully registered numbers!

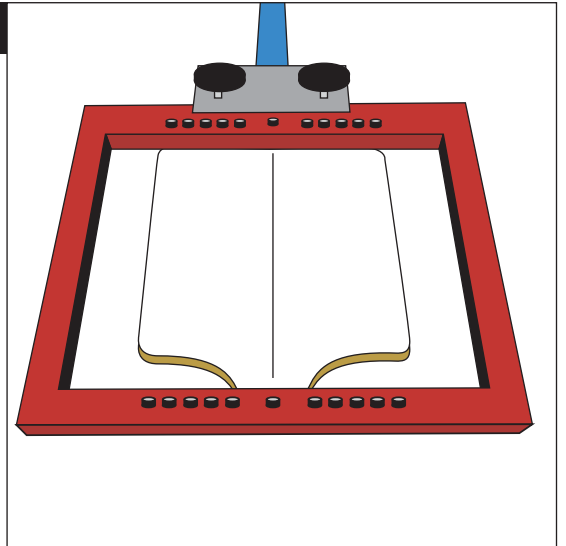

QUICKDRAW

Printing 1 Digit Numbers

STEP 1 - 1DIGIT 1COLOR

To print single digit single color numbers simply place the desired number into the center pins on the master frame, apply ink and print. Lift the master frame out of the print position and remove garment from the shirtboard, then run it through your dryer.

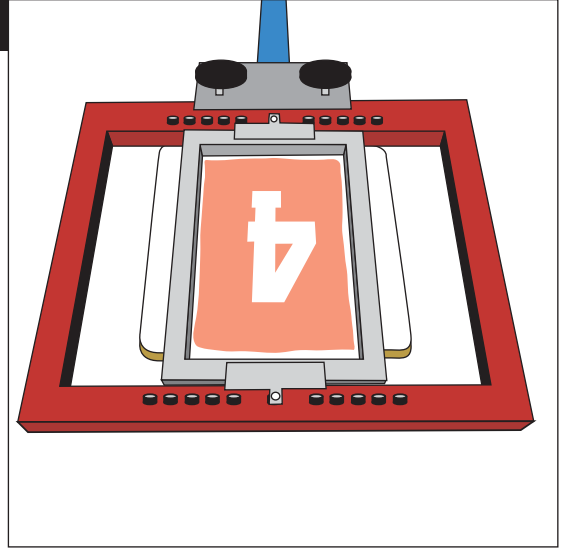

STEP 1 - 1DIGIT 2COLOR

To print single digit 2 color numbers start by first placing the base color of the desired number onto the center pins of the master frame. Apply ink and print. Lift the master frame out of the print position and flash cure the base color.

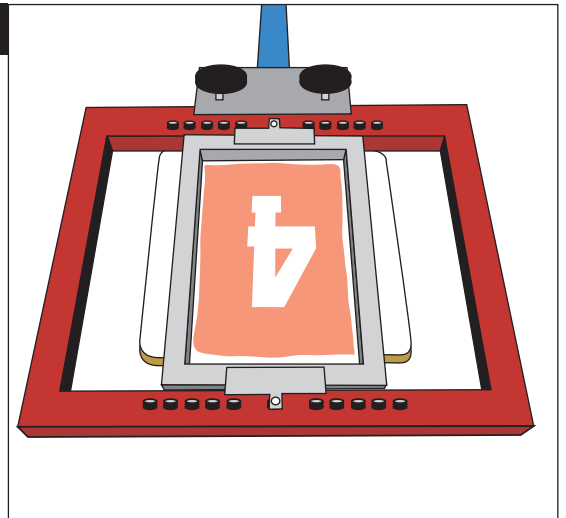

STEP 2 - 1DIGIT 2COLOR

Now remove the screen with the base color and install the outline screen for the same number in the center pins of the master frame. Apply ink and print. you now have a 2 color single digit number. Remove the garment from the shirtboard and run through your dryer.

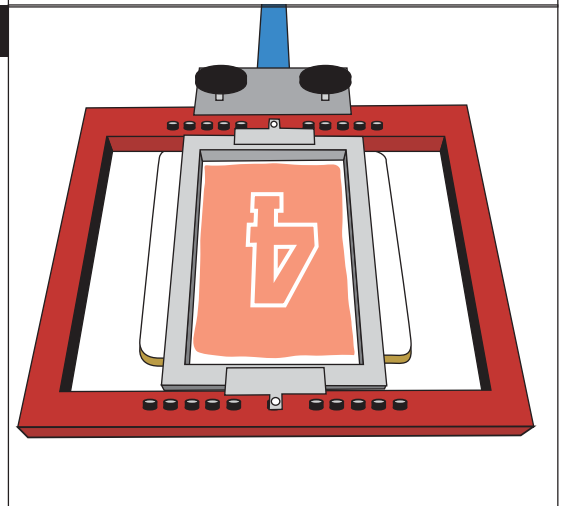

QUICKDRAW

Printing 2 Digit Numbers

STEP 1 - 2 DIGITS

To print two digit numbers place the first digit on the side pin for that size font, in this case we are printing an 8" high number 44 so the first 4 goes onto the right side pins marked 8". Apply ink and print.

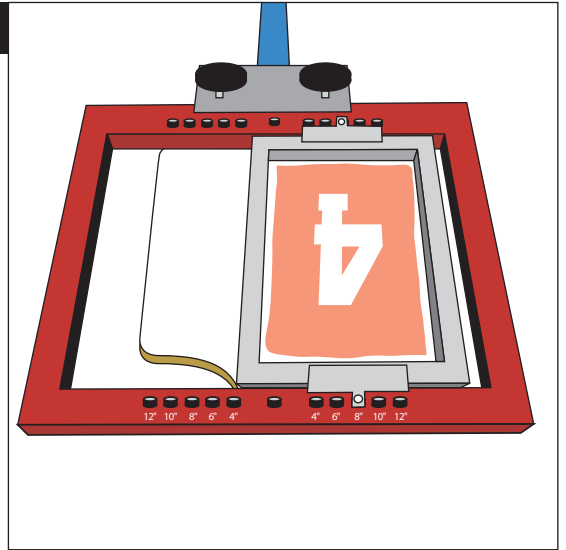

STEP 2 - 2 DIGITS

Move the master frame out of the print position and flash cure the first number.

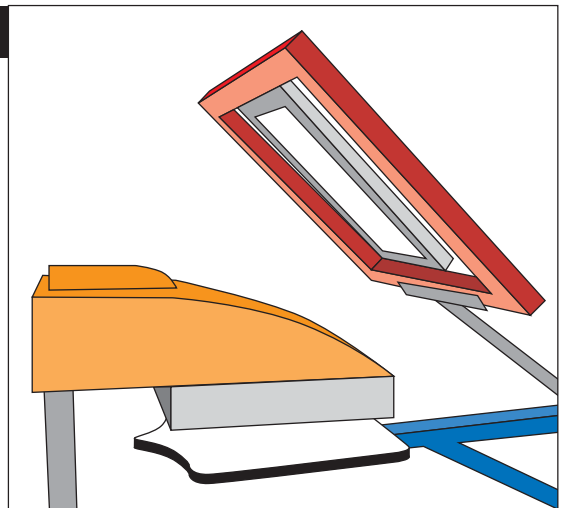

STEP 3 - 2 DIGITS

To print the second digit place the next number screen onto the left side pins for that size font, in this case we are printing 8" high numbers so the second digit goes onto the left side pins marked 8". Apply ink and print. you now have a 2 digit number. Remove the garment from the shirtboard and run through your dryer.

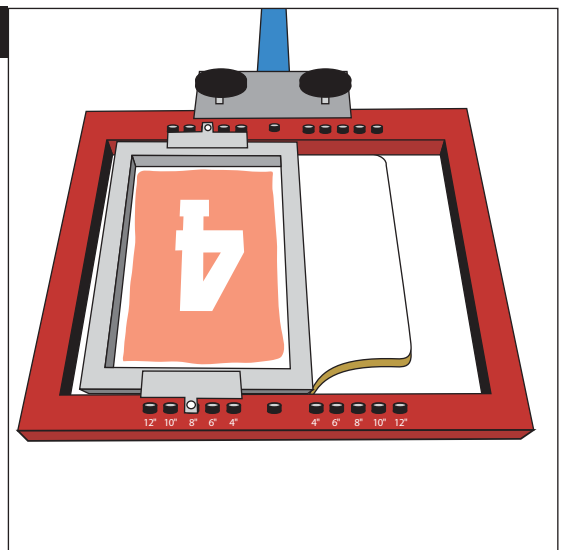

QUICKDRAW

Printing with #1

STEP 1 - PRINT # 11

Because the #1 is narrower than the other numbers you will need to offset the number screens to accommodate the gap between the two #1's. For instance, when printing #11 with 10" high numbers you would print the left #1 in the left side pins marked 8", flash cure the first digit and then you would print the right #1 in the right side pins marked 8". This will close the gap and make the #11 look correct.

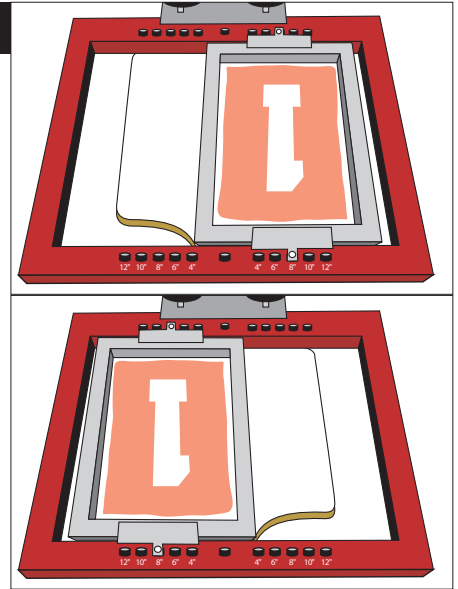

STEP 2 - PRINT TEEN #'S

To print teen numbers you would first place the 8" high #1 screen onto the right side pins marked 8", print the digit, flash cure the digit, and then you would place the second digit, in this case an 8" high #4, onto the left side pins marked 6". This will center the overall #14 onto the garment.

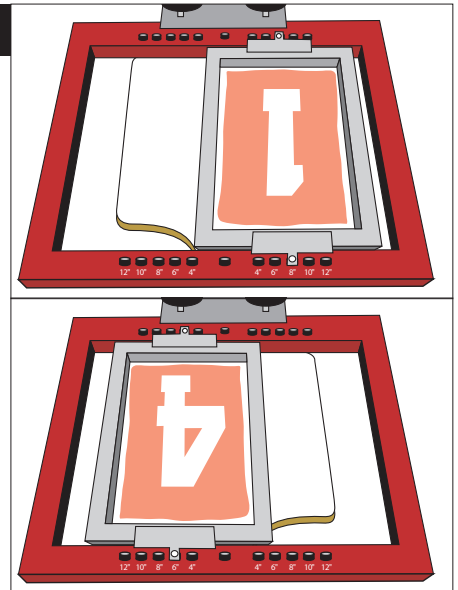

STEP 3 - PRINT 21,31,etc.

To Print numbers 21,31,41 etc. you will need to first place the 8" high #4 screen onto the right side pins marked 6", print the digit, flash cure the digit, and then you would place the second digit, in this case an 8" #1 onto the left side pins marked 8". This will center the overall #41 onto the garment.

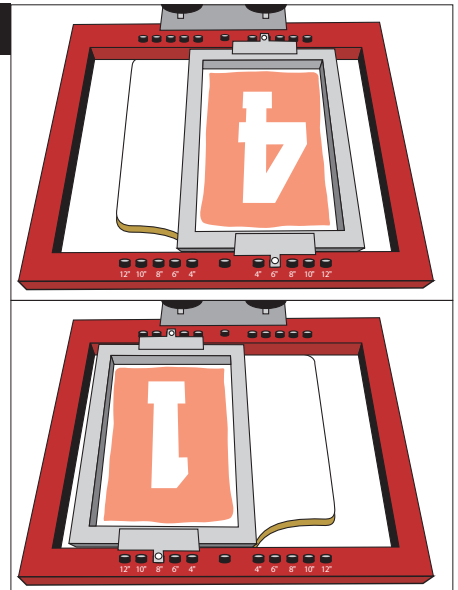

QuickDraw

We have included film for the Number "11" some of our customers have requested this for the 4" number set, as there are no pins to compensate for the difference in the width of the "1" digits. We have also in Number "1" offset to the right for use with the Teen Digits, (ex: 12, 13,. 14 etc.) and the Number "1" offset to the left for your digits 21, 31, 41 etc.

