

# ICECO

## GO12



If there are any problems, please email us:  
[official@icecofreezer.com](mailto:official@icecofreezer.com)



# Catalogue

<b>1</b>	<b>What's Inside</b>	-----	<b>1</b>
<b>2</b>	<b>Operation</b>	-----	<b>2</b>
<b>3</b>	<b>Care And Maintenance</b>	-----	<b>9</b>
<b>4</b>	<b>Error Codes &amp; Solutions</b>	-----	<b>10</b>
<b>5</b>	<b>Warranty &amp; Return Policy</b>	-----	<b>12</b>
<b>6</b>	<b>Troubleshooting (Q &amp; A)</b>	-----	<b>13</b>
<b>7</b>	<b>APP Control</b>	-----	<b>18</b>
<b>8</b>	<b>Safety Instructions</b>	-----	<b>20</b>

# 1 What's Inside



**Refrigerator x1**

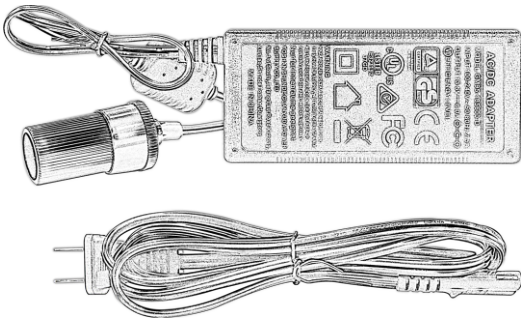

**80W Universal  
AC Adapter x1**

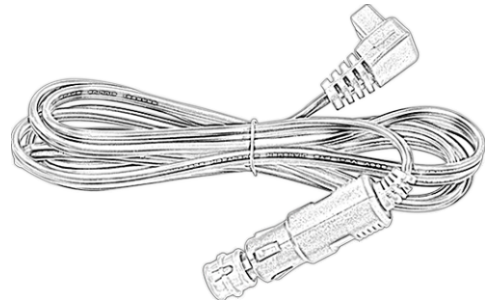

**12/24V DC Cigarette  
Lighter Plug Cable x1**

## 2 Operation

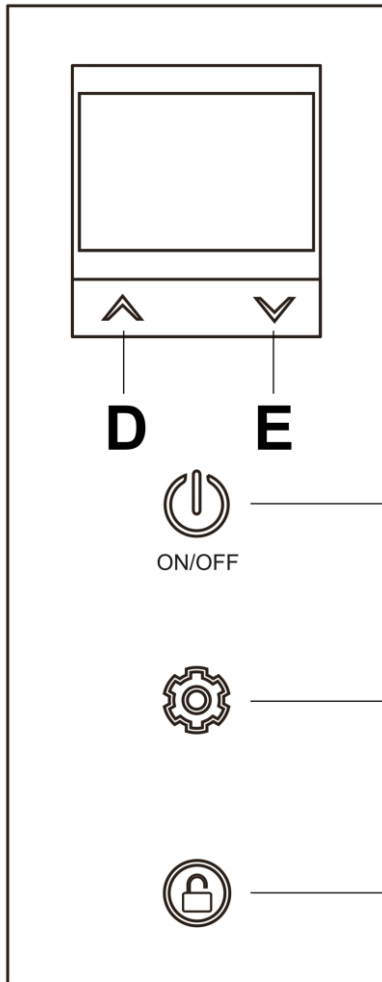

**A** Power ON / OFF Button

**B** Function Button  
(MAX & ECO mode)

**C** "Locked" or "Unlock" Button

**D** Temp. Setting UP

**E** Temp. Setting DOWN

## 2.1 Switched-on/off

### Power On

With the fridge plugged in, press and hold the A (Power) Button for 3 seconds.

### Power Off

Press and hold the A (Power) Button for 3 seconds.

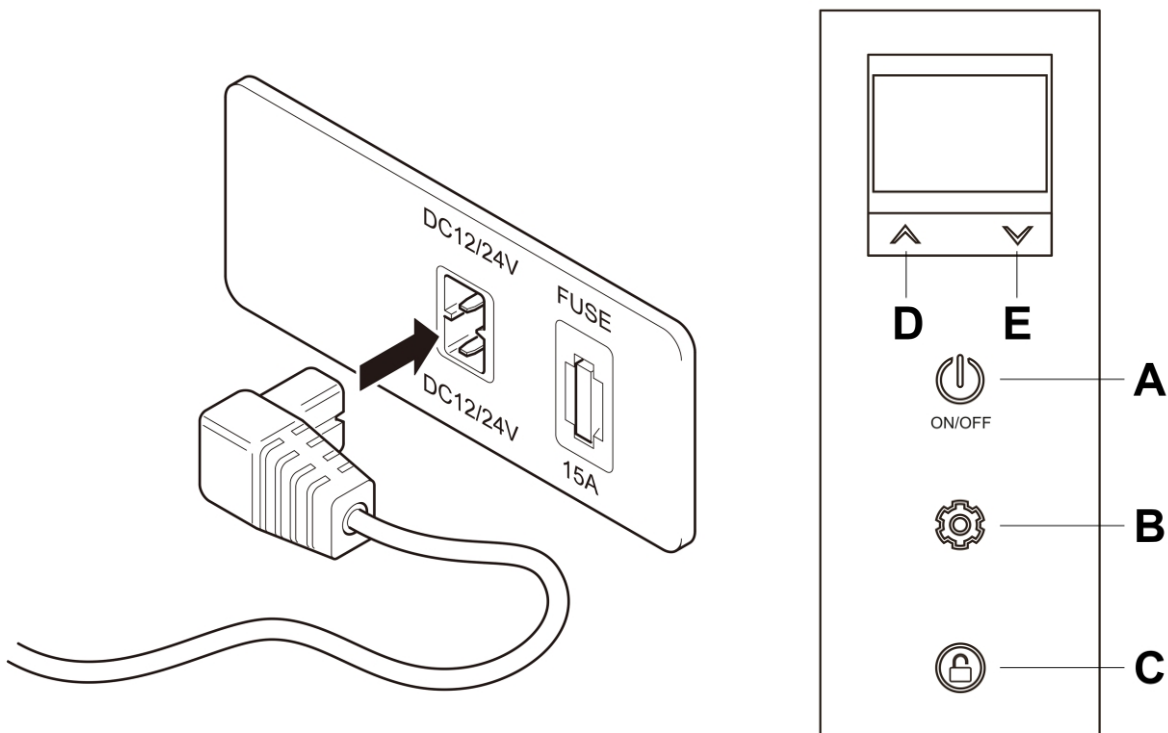

## 2.2 MAX & ECO Mode

With the unit turned on (Press & Hold A/Power Button), you can press the Button B to toggle between MAX or ECO compressor speed for the fridge.

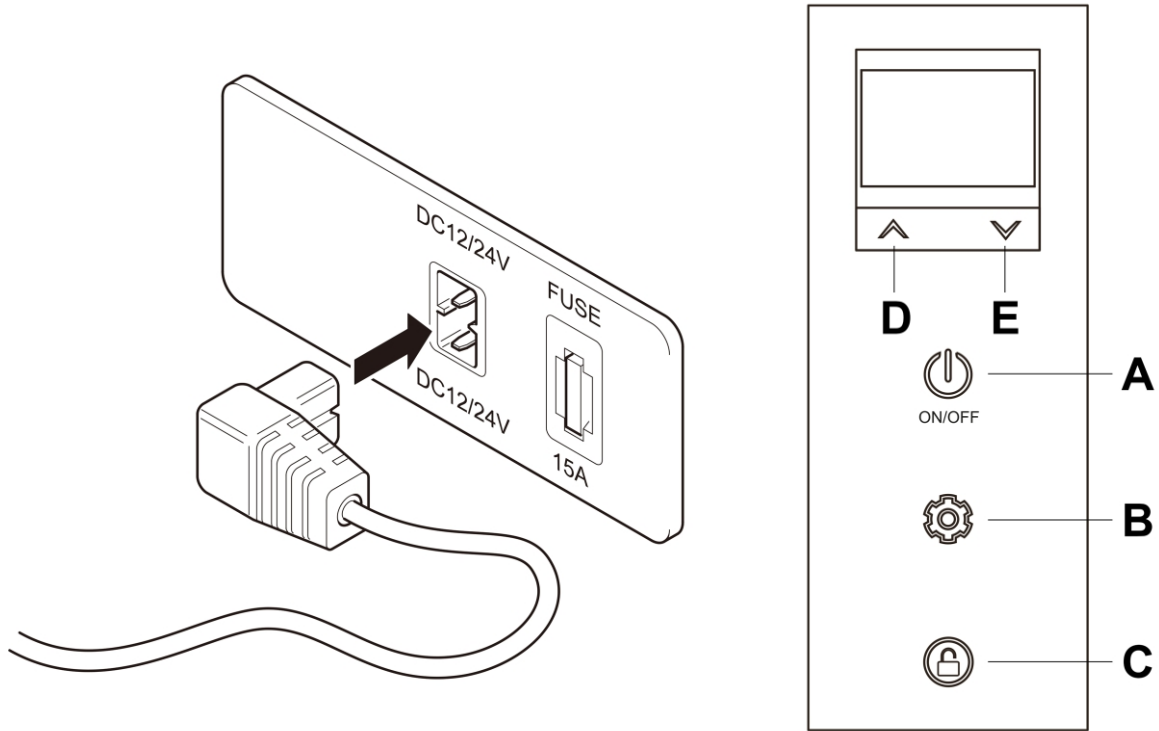

## 2.3 Unlock Button

With the fridge powered on, press and hold the Button C to unlock the fridge's control interface.

- The fridge will lock its control interface after 90 seconds of no control inputs, to prevent accidental changes from being made.
- You can press and hold the Button C (Unlock) for 3 seconds to unlock the control interface.

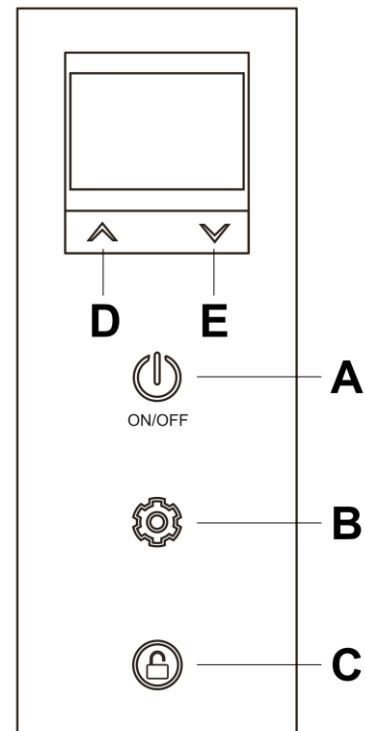
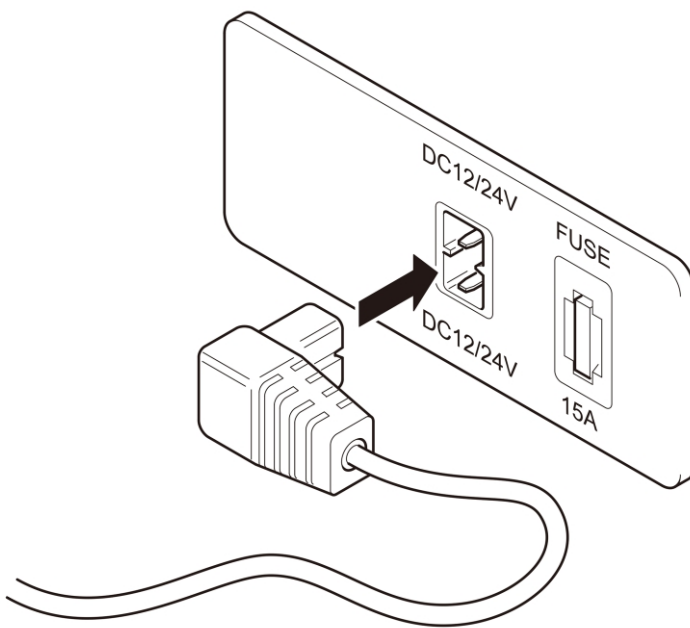



## 2.4 Battery Protection Mode

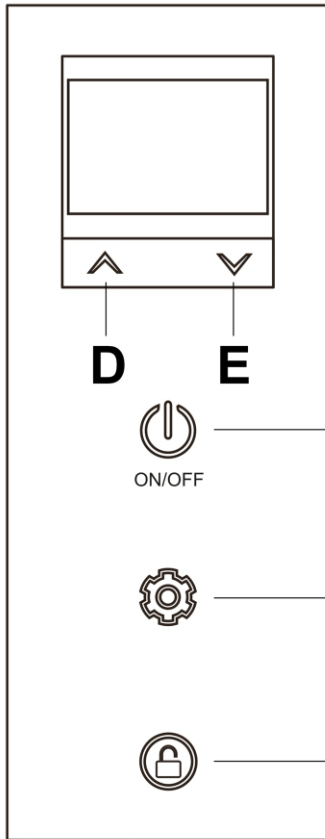

In standby mode (fridge turned off but plugged into power), press and hold the D Button and E Button at the same time for 3 seconds, and you should be able to toggle between Battery Protection Levels and C/F settings using the A Button.

The battery protection levels are represented by 3 dashes on the display.

There are 3 protection levels available and you can select it using the D/E Button.

**NOTE:** Details of Battery Protection Mode could be found in Page 15.

## 2.5 Off-Set Value

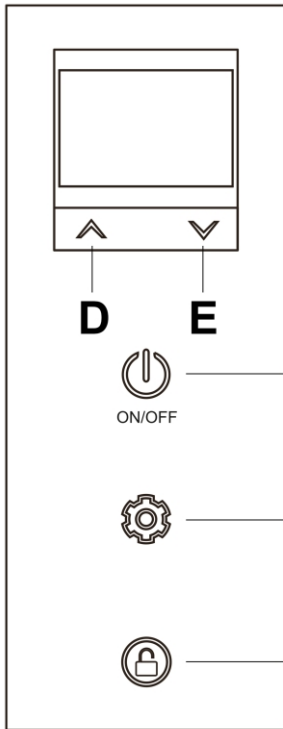

In standby mode (fridge turned off but plugged into power), press and hold the D Button and E Button at the same time, short press A Button for times, and you should be able to switch between F1/F2/F3 off-sets value by pressing the A Button.

**TIP:** We do not recommend our customer to adjust the temperature off-set value unless necessary or there is an obvious temperature measurement deviation from actual temperature.

The following table details the temperature zones each setting parameter affects, as well as their default values.

OFF-SET	FUNCTION	WHEN SHIPMENT
<b>F1</b>	Set temperature $\geq 0^{\circ}\text{C}$ , temperature compensation value	$1^{\circ}\text{C}$ ( $33.8^{\circ}\text{F}$ )
<b>F2</b>	$-1^{\circ}\text{C} \geq$ Set temperature $\geq -14^{\circ}\text{C}$ , temperature compensation value	$2^{\circ}\text{C}$ ( $35.6^{\circ}\text{F}$ )
<b>F3</b>	Set temperature $\leq -15^{\circ}\text{C}$ , temperature compensation value	$3^{\circ}\text{C}$ ( $37.4^{\circ}\text{F}$ )

## 2.6 Switch Between °C to °F

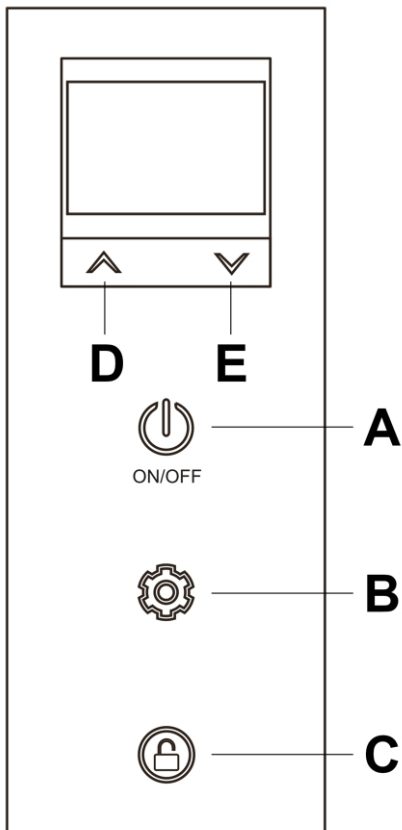

In standby mode (fridge turned off but plugged into power), press and hold the D Button and E Button at the same time for 3 seconds, and you should be able to toggle between Battery Protection Levels and C/F settings using the A Button. Once you see either a C or F, you can use D/E Buttons switch between the two. (Default: °F)

**TIP:** When the temperature is set, the display will return to show the current temperature inside the refrigerator.

## **3 Care And Maintenance**

### **3.1 Cleaning**

Please use a wet cloth and warm water mixed with gentle non-abrasive detergents to clean the interior and exterior of your fridge.

### **3.2 DOs and DON'Ts**

- Please power off and unplug the unit before cleaning
- Please use non-abrasive detergent to cleaning the interior/exterior of the fridge
- Please don't scrap the interior of the fridge to defrost/de-ice the fridge
- Please don't pressure-wash/spray the fridge with a running water hose

## 4 Error Codes & Solutions

	<b>Error Code</b>
<b>E1</b>	※ The DC voltage is below the protection setting and the battery protection mode is activated.
<b>E2</b>	※ The cooling fan overloads with more than 1 A of current.
<b>E3</b>	Motor start error ※ The motor of compressor is blocked or the pressure difference in the refrigeration system is too high.
<b>E4</b>	Minimum motor speed error ※ The compressor overloads and the motor can not maintain its minimum speed 1850 rpms.
<b>E5</b>	Thermal cut-out of electronic unit ※ Thermal cut-out error If the refrigeration system overloads, or the ambient temperature is too high, the thermal sensor is overheated.

# Solutions

If this error code appears when the fridge is operating on 12V DC, please try to lower the battery protection setting and see if the error is resolved. The battery protection mode may be triggered prematurely on certain vehicles due to small wiring imperfections, contributing to a measured DC voltage drop at compressor start-up. Lowering the battery protection setting may resolve this issue.

Please also try to take a voltage reading of your battery to make sure it is not depleted/discharged.

If possible, please connect the AC power cord to try if the refrigerator appears E1 code.

Please contact us directly if the error persists.

## **5 Warranty & Return Policy**

- 30-day money back guaranty upon receiving goods.
- 5 year Compressor Warranty.
- 1 year General Warranty.

**For returns or exchanges, please fill out the following return and exchange registration form in the package as a proof of return. All materials must be returned in the original condition and packaging. Thank you for your cooperation.**

**If the product is received damaged or defective during transportation, you need to contact our customer service within 2 business days. Make sure to provide relevant photos or videos, your order ID number and your name. A customer service agent will help assist into solving the issue at a timely manner. (Return, Exchange, or Discount Compensation) A free return label will be provided if needed.**

# 6 Troubleshooting (Q & A)

## 1. Heat resistance & water resistance

### Heat resistance

ICECO refrigerators are engineered to operate at an ambient temperature of up to 55 °C (131 °F).

### Weather Proof

ICECO refrigerators can operate under light rain conditions. Please keep the vents above clear of water, and please add some clearances to the bottom of the fridge if the ground is wet.

We DO NOT recommend exposing the fridge to moderate or heavy rain.

As with all electrical appliances, over-exposure to moisture may shorten the fridge's life.



## 2. How long can the ICECO refrigerator keep the temperature after powering off?

The following data only represents the situation when the refrigerator is empty. Due to different samples, it is normal to have differences.

### Insulation Performance

Model	Insulation Test
GO12	Ambient temperature of 25°C (77°F), refrigerator temperature from -18°C (0°F) to 20°C (68°F) needs about 3 hours on average.

## 3. Why did it change back to the original temperature after setting the temperature?

The Solid/Non-Flashing number on the display is the CURRENT interior temperature. The Flashing number is your SET temperature after adjustment. The compressor will shut off when the SET temperature is reached.

#### 4. What should I do if the refrigerator is upside down when it is delivered?

Please leave your refrigerator upright for 24 hours to allow the compressor lubricant to resettle before powering on the fridge. Otherwise it may contribute to certain operation abnormalities.

#### 5. What is the function of triple battery protection? How do they work?

The triple battery protection is designed to prevent over-discharge and battery depletion. When the measured DC voltage is below the set value, the compressor is shut off to prevent battery depletion.

VOLTAGE	DISPLAY	12V		24V	
		CUT OFF (V)	CUT IN (V)	CUT OFF (V)	CUT IN (V)
LOW	1 Bar ---	9.4	10.4	21.1	22.7
MED	2 Bars ===	10.9	12.0	22.0	23.6
HIGH	3 Bars ===	11.6	12.7	24.0	25.6

For example, when you switch to a LOW MODE, the battery voltage is lower than 9.6 volts, the refrigerator will automatically power off; When the battery voltage reaches 10.9 volts, the refrigerator will start again.

## 6. What is the power draw in max/ fast cooling mode?

<b>Model</b>	<b>Electrical Power</b>	<b>Model</b>	<b>Electrical Power</b>
<b>GO12</b>	50W	<b>JP42</b>	55W
<b>GO20</b>	50W	<b>VL35 Series</b>	65W
<b>JP Series</b>	60W	<b>VL Series</b>	85W

This data is only suitable for laboratory testing, and the actual power is subject to actual conditions.

## **7. Why is there a temperature difference (between the actual temperature of the refrigerator and the set temperature)?**

Because of the sinking nature of cold air, different temperatures may exist in different locations in the refrigerator (the temperature of the bottom will be the lowest). The panel only shows the center temperature of the refrigerator.

## **8. What kind of cable do I need to use in the car and at home?**

The DC cable is provided with your fridge. You can power it from your vehicle's cigarette lighter plug using the DC cable. You can also power it at home, but you need to use with AC Adapter as precondition.

## **9. What is the specification of the fuse of the refrigerator?**

The supply line is protected by a 15A fuse located in the refrigerator.

# 7 App Control



## APP Download and Installation:

Users of Android mobile phone can download in Android market, and iPhone users can download from IOS App Store.

## Register/Log Into APP

Register with your phone number  
▼  
Become a member of us  
▼  
Log into the APP after registration

## Instruction:

Log into the APP, with Bluetooth on, and click “Add Devices”. The APP will search for available fridge, and enter the instruction display when it connects with your fridge.

## [State]

Click “” to control turning on/off of the fridge. When it is on, its working state can be checked, including the temp, voltage, electric quantity, mode, temp graph.

## [Setting]

- Temperature control: the temp can be adjusted from  $-18^{\circ}\text{C}$  to  $10^{\circ}\text{C}$ . Click or slide to control.
- Celsius and Fahrenheit switch: Celsius and Fahrenheit can be switched. Click or slide to switch.
- Battery protection mode: three modes—high, medium, low. Click or slide to change. Do not change it optionally. The mode should be set according to your vehicle battery, and medium is recommended.
- After finishing the setting, switch to “state” display to check the state information of the fridge.

## **8 Safety Instruction**

### **SAFETY INSTRUCTIONS**

Please read the user manual and safety instructions carefully before using the appliance.

By ignoring the safety instructions, the manufacturer cannot be held responsible for the damage.

The use of accessories that are not recommended by manufacturer can cause injuries and will invalidate any warranty that you may have.

The appliance shall not be exposed to moderate/heavy rain.

Place the refrigerator on a dry, secure surface, with adequate ventilation.

- ❗ Do not leave the refrigerator unattended in uncovered, outdoor areas exposed to the elements.**
- ❗ Do not use this appliance near direct heat sources, such as an open flame or radiator.**
- ❗ Do not place open containers of liquid inside the fridge.**
- ❗ Please don't put hot/warm food into the fridge directly without letting it cooling off. Place/arrange the content of your fridge securely when using the refrigerator inside a moving vehicle.**

To maximize energy savings, please make sure the lid is closed and secure, and only open the fridge when you need to.

The power cable must only be replaced by qualified technical personnel and by an assistant body authorized by the manufacturer.

Before carrying out any maintenance operations on the refrigerator, disconnect all power sources from the fridge.

This appliance is suitable for camping use.



## **WARNING!**

- ! Please keep the fridge in a well ventilated area.**
- ! Do not use mechanical devices or other means to accelerate the defrosting process, other than those recommended by the manufacturer.**
- ! Do not use electrical devices inside the food storage compartments of the appliance, unless approved/recommended by the manufacturer.**
- ! Do not store explosive items, such as aerosol cans with a flammable propellant in this appliance.**
- ! Risk of fire and electrical shock.**
- ! Do not let hot items touch the plastic parts of the appliance.**
- ! Do not put flammable products or items in, near or on the appliance.**

- ❗ Do not touch the compressor or the condenser when the fridge is operating. They may be very hot.**
- ❗ When setting up the appliance, ensure the supply cord is not trapped or damaged.**

**Further information is provided on the technical data label inside the product.**

1. This appliance is not intended for use by persons (including children) with reduced physical, sensory or mental capabilities, or lack of experience and knowledge, unless they have been given supervision or instruction concerning use of the appliance by a person responsible for their safety.
2. Children should be supervised to ensure that they do not play with the appliance.

3. This appliance is intended to be used in household and similar applications such as

- staff kitchen areas in shops, offices and other working environments;
- farm houses and by clients in hotels, motels and other residential type environments;
- bed and breakfast type environments;
- catering and similar non-retail applications.

4. If the supply cord is damaged, it must be replaced by the manufacturer, its service agent or similarly qualified person in order to avoid a hazard.

5. Do not store explosive substances such as aerosol cans with a flammable propellant in this appliance.

6. **DANGER:** Risk of child entrapment. Before you throw away your old refrigerator or freezer:

**\* Take off the doors.**

**\* Leave the shelves in place so that children may not easily climb inside.**

**ICECO**

Cooler Than A Cooler