

# PROFESSIONAL WEATHER STATION

## Operation Manual

### Model: WN1980

## Table of Contents

1. Introduction .....	3
2. Warnings and Cautions .....	3
3. Quick Start Guide.....	3
4. Pre-Installation Checkout and Site Survey.....	4
4.1 Pre Installation Checkout.....	4
4.2 Site Survey.....	4
5. Setting Started .....	4
5.1 Contents.....	5
5.2 Sensor Array Set Up.....	5
5.2.1 Install U-bolts and mounting pole .....	6
5.2.2 Install wind vane .....	7
5.2.3 Install wind speed.....	7
5.2.4 Install Rain Gauge.....	7
5.2.5 Install Batteries .....	8
5.2.6 Mount assembled outdoor sensor package .....	9
5.2.6.1 Before you mount .....	9
5.2.6.2 Mounting .....	9
5.2.7 Reset Button and Transmitter LED .....	10
5.3 Optional sensors .....	10
5.4 Indoor/Outdoor Thermo-Hygrometer, 8 Channel (optional).....	12
5.5 Best Practices for Wireless Communication .....	14
5.6 Display console .....	15
6. Display Console Operation .....	17
6.1 Screen Display .....	17
6.2 Initial Display Console Set Up.....	18
6.2.1 Key function .....	18
6.3 Setting mode .....	19
6.4 Barometric Pressure Display.....	21
6.4.1 Viewing Absolute vs. Relative Pressure.....	21
6.4.2 Rate of Change of Pressure Graph .....	22
6.4.3 Relative Pressure Calibration Discussion.....	22
6.5 Rain Display .....	23
6.5.1 Rain Increments of Measure .....	23
6.5.2 Increments of Rain Definitions .....	23

6.6 Wind Display .....	23
6.7 Temperature Display .....	24
6.7.1 Wind Chill, Dew Point and Heat Index Display .....	24
6.8 Alarms .....	24
6.8.1 Viewing High and Low Alarms.....	24
6.8.2 Setting High and Low Alarms.....	25
6.9 Max/Min Mode .....	29
6.9.1 Viewing Max/Min Values.....	29
6.9.1.1 Display Wind Chill, Heat Index vs. Dew Point Max/Min Values .....	29
6.9.1.2 Display Wind Speed vs. Wind Gust Max Values ....	29
6.9.1.3 Display Hourly Rain, Rain Rate .....	30
6.9.1.4 Display Absolute and Relative Pressure Min and Max Values .....	30
6.10 Resynchronize Wireless Sensor.....	30
6.11 Backlight Operation .....	30
6.11.1 With USB cable (included).....	31
6.11.2 Without USB Power supplied .....	31
6.12 Tendency Arrows .....	31
6.13 Wireless Signal Quality Indicator .....	31
6.14 Weather Forecasting.....	32
6.14.1 Storm Alert .....	32
6.14.2 Weather Forecasting Description and Limitations.....	32
7 Specification:.....	33
8 Live Internet Publishing.....	35
8.1 Configure Wi-Fi via BLE to connect the Weather Station Console.....	36
8.1.1 Download mobile application .....	36
8.1.2 Configure Wi-Fi via BLE.....	错误！未定义书签。
8.1.2.1 Apple iOS user.....	错误！未定义书签。
8.1.2.2 Android user:.....	错误！未定义书签。
8.2 Ecowitt Weather .....	41
9. Registering WeatherUnderground.com through the PC or Mac .....	45
10. Other functions on WS View Plus.....	52
10.1 WU Dashboard vs Live Data .....	52
10.2 Manage Wunderground .....	52
10.3 Settings .....	53
10.4 Manage Ecowitt.....	53
10.5 Direct Connection & Test Mode.....	54
10.6 Calibration .....	56
10.7 Editing Rain totals .....	56
10.8 Device Settings.....	57
10.9 Sensor ID .....	57
11 Maintenance .....	57

# 1. Introduction

Thank you for your purchase of the Wireless Wi-Fi Weather Station. The following user guide provides step by step instructions for installation, operation and troubleshooting.

# 2. Warnings and Cautions

 **Warning:** Any metal object may attract a lightning strike, including your weather station mounting pole. Never install the weather station in a storm.

 **Warning:** Installing your weather station in a high location may result in injury or death. Perform as much of the initial check and operation on the ground and inside a building or home. Only install the weather station on a clear, dry day.

# 3. Quick Start Guide

Although the manual is comprehensive, much of the information contained may be intuitive. In addition, the manual does not flow properly because the sections are organized by components.

The following Quick Start Guide provides only the necessary steps to install, operate the weather station, and upload to the internet, along with references to the pertinent sections.

<b>Required</b>		
<b>Step</b>	<b>Description</b>	<b>Section</b>
1	Assemble and power up the integrated sensor array	5.2.1–5.2.3
2	Power up the display console and synchronize with sensor array	5.6
3	Set date and time on console	6.4.5
4	Calibrate the relative pressure to sea-level conditions (local airport) on console	6.4.3
5	Mount the sensor array	5.2.6
6	Reset the rain to zero on console	6.4.8
<b>Optional</b>		
7	Configure Wi-Fi connection	8.1
8	Register and upload to Weather Server	9

**Table 1: Quick Start Guide**

## **4. Pre-Installation Checkout and Site Survey**

### **4.1 Pre Installation Checkout**

Before installing your weather station in the permanent location, we recommend operating the weather station for one week in a temporary location with easy access. This will allow you to check out all of the functions, insure proper operation, and familiarize you with the weather station and calibration procedures. This will also allow you to test the wireless range of the weather station.

### **4.2 Site Survey**

Perform a site survey before installing the weather station. Consider the following:

1. Clean the rain gauge every few months and change the batteries every 2-3 years. Provide easy access to the weather station.
2. Avoid radiant heat transfer from buildings and structures. Install the sensor array at least 2 meter from any building, structure, ground, or roof top.
3. Avoid wind and rain obstructions. The rule of thumb is to install the sensor array at least four times the distance of the height of the tallest obstruction. For example, if the building is 20' tall, and the mounting pole is 6' tall, install  $4 \times (20 - 6) = 56'$  away.
4. Wireless Range. The radio communication between receiver and transmitter in an open field can reach a distance of up to 100 meters, providing there are no interfering obstacles such as buildings, trees, vehicles, high voltage lines. Wireless signals will not penetrate metal buildings. Under most conditions, the maximum wireless range is 30m.
5. Radio interference such as PCs, radios or TV sets can, in the worst case, entirely cut off radio communication. Please take this into consideration when choosing console or mounting locations. Make sure your display console is at least five feet away from any electronic device to avoid interference.

## **5. Setting Started**

Item need to be powered by DC power!

## 5.1 Contents

1	Display Console
1	Outdoor Sensor with built-in: Thermo-hygrometer / Rain Gauge / Wind Speed Sensor/ Wind Direction Sensor
1	Wind speed cups (to be attached to outdoor sensor body)
1	Wind vane (to be attached to outdoor sensor body)
2	U-Bolts for mounting on a pole
4	Threaded nuts for U-Bolts (M6 size)
1	Metal mounting plate to be used with U-Bolts
1	Wrench for M6 bolts
1	USB to 2.5*0.7mm DC 5V power plug connector cable
1	User manual (this manual)

**Table 2: Package content**

## 5.2 Sensor Array Set Up

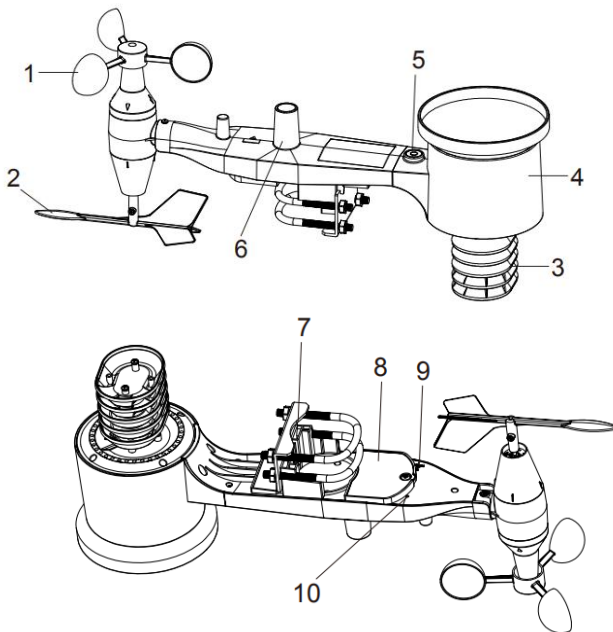

**Figure 1: Sensor assembly components**

1 Wind speed cups	6 Antenna
2 Wind vane	7 U-Bolts
3 Thermo- and hygro-meter sensors	8 Battery compartment door
4 Rain collector	9 Reset button
5 Bubble level	10 LED (red) to indicate data transmission

**Table 3: Sensor assembly detailed items**

### 5.2.1 Install U-bolts and mounting pole

Installation of the U-bolts, which are in turn used to mount the sensor package on a pole, requires installation of an included metal plate to receive the U-bolt ends. The metal plate, visible in Figure 2, has four holes through which the ends of the two U-Bolts will fit. The plate itself is inserted in a groove on the bottom of the unit. Note that one side of the plate has a straight edge (which goes into the groove), the other side is bent at a 90-degree angle and has a curved profile (which will end up “hugging” the mounting pole). Once the metal plate is inserted, remove nuts from the U-Bolts and insert both U-bolts through the respective holes of the metal plate as shown in Figure 2.

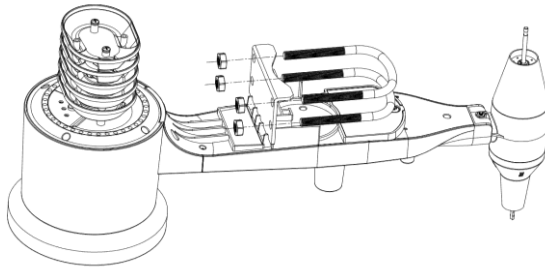

**Figure 2: U-Bolt installation**

Loosely screw on the nuts on the ends of the U-bolts. You will tighten these later during final mounting. Final assembly is shown in Figure 3.

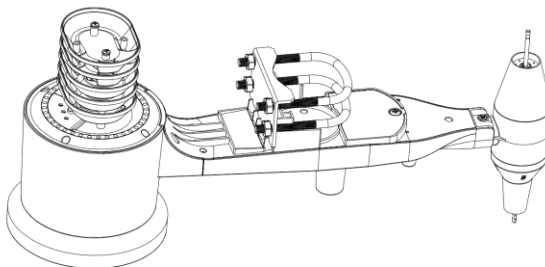

**Figure 3: U-Bolts and nuts installed**

The plate and U-Bolts are not yet needed at this stage but doing this now may

help avoid damaging wind vane and wind speed cups later on.

### 5.2.2 Install wind vane

Push the wind vane onto the shaft on the bottom of the sensor, until it stops moving further, as shown in figure 4.

Tighten the set screw, with a Philips screw driver (size PH0), until the wind vane cannot be removed from the axle, as shown in figure 4. Make sure the wind vane spin freely. The wind vane's movement has a small amount of friction, which is helpful in providing steady wind direction measurements.

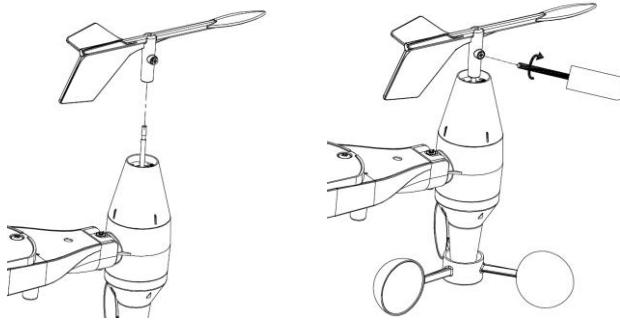
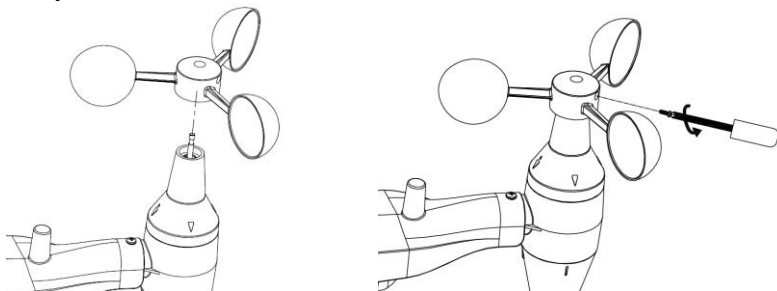

**Figure 4: Wind vane installation diagram**

### 5.2.3 Install wind speed

Push the wind speed cups into the shaft as shown in figure 5.

Tighten the set screw with screw driver. Make sure the wind speed cups can spin freely.

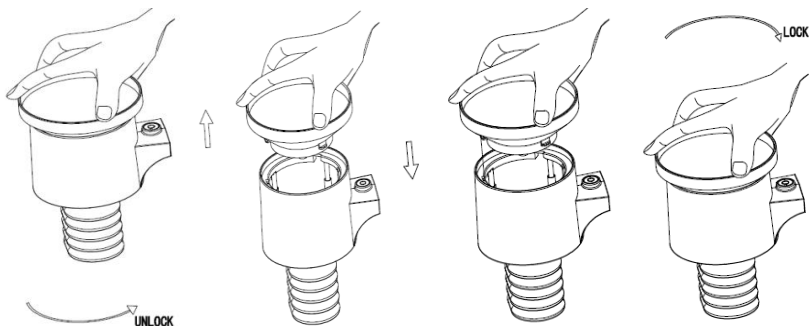

**Figure 5: Wind speed cup installation diagram**

### 5.2.4 Install Rain Gauge

Install the rain gauge funnel. Rotate clockwise to attach the funnel to the

outdoor sensor.



**Figure 6: Rain gauge installation and maintenance**

### 5.2.5 Install Batteries

Insert 2XAA batteries in the battery compartment. The LED indicator on the back of the transmitter will turn on for four seconds and normally flash once every 16 seconds (the sensor transmission update period).

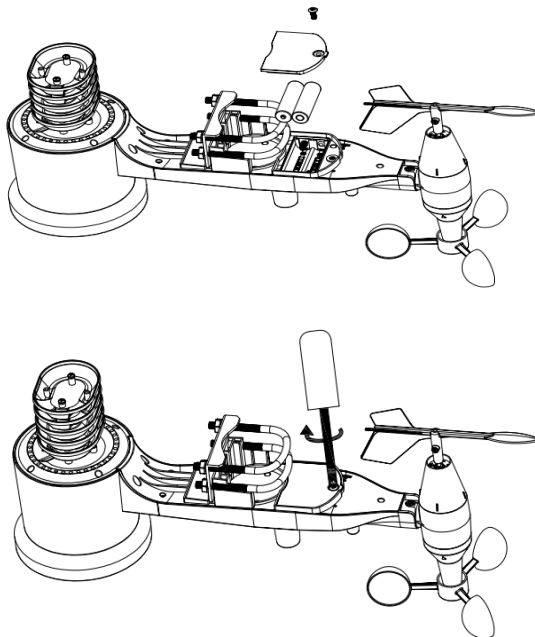

**Figure 7: Battery installation diagram**



**Note:** If no LED light up or is permanently on, make sure the batteries are inserted the correct way or a proper reset has happened. Do not install the batteries backwards. You can permanently damage the outdoor sensor.

**Note:** We recommend 1.5V lithium batteries for cold weather climates, but alkaline batteries are enough for most climates. We do not recommend rechargeable batteries. They have lower voltages, they do not operate well at wide temperature ranges, and do not last as long, resulting in poorer reception.

## 5.2.6 Mount assembled outdoor sensor package

### 5.2.6.1 Before you mount

Before proceeding with the outdoor mounting detailed in this section, you may want to skip to setup instructions in section 6 and onwards first, while you keep the assembled outdoor sensor package nearby (although preferably not closer than 5 ft. from the console). This will make any troubleshooting and adjustments easier and avoids any distance or interference related issues from the setup.

After setup is complete and everything is working, return here for outdoor mounting. If issues show up after outdoor mounting they are almost certainly related to distance, obstacles etc.

### 5.2.6.2 Mounting

You can attach a pipe to a permanent structure and then attach the sensor package to it (see Figure 8). The U-Bolts will accommodate a pipe diameter of 1-2 inches (pipe not included).

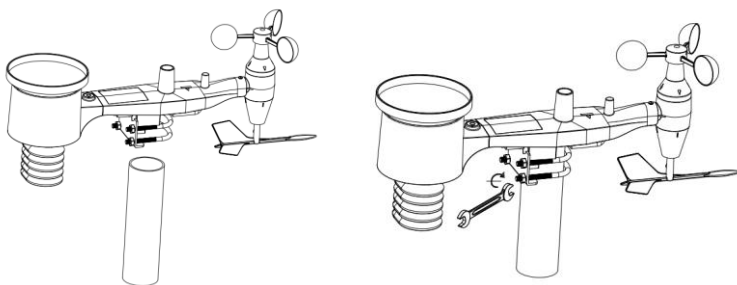

**Figure 8: Sensor package mounting diagram**

Finally, place the sensor package on top of the prepared mounting pipe. The U-Bolts should be loose enough to allow this but loosen the nuts as necessary. Once placed, hand tightens all four nuts, taking care to do so evenly.

Now you will need to align the whole package in the proper direction by

rotating it on top of the mounting pipe as needed. Locate the arrow labeled “WEST” that you will find on top of the sensor package right next to the antenna. You must rotate the whole sensor package until this arrow points due West. To achieve proper alignment, it is helpful to use a compass (many cell phones have a compass application).

Once rotated in the correct orientation, lightly tighten the bolts a little more (use a wrench) to prevent further rotation.

**Note:** Use the bubble level next to the rain sensor to make sure the sensor array is completely level. If the sensor is not level then the rain gauge will measure inaccurately.

### 5.2.7 Reset Button and Transmitter LED

In the event that the sensor array is not transmitting, reset the sensor array.

With an open ended paperclip, press and hold the **RESET BUTTON** for three seconds and resynchronize with console by powering down and up the console. Please put the console with the sensor array about 3 meters away.

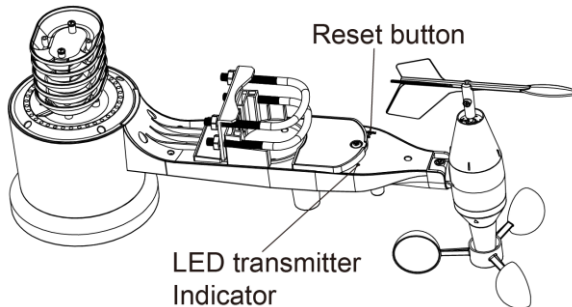

**Figure 9: Reset button and Transmitter LED location**

### 5.3 Optional sensors







Important: When more sensors, excluding the original sensor array, to be paired with the display, DC power supply must be applied as console will turn on its RF receiver permanently, this increases the current consumption significantly.





Optional sensor data can be viewed by WS View Plus APP on its live data page. Console LCD is reserved for integrated sensor array data hosting only!!

The following optional sensors (sold separately) can be used with console display.

If you have purchased extra sensors, just simply power them up, the display console will receive the data automatically and send the data directly to Ecowitt.net (requires to set the console uploading to ecowitt.net first). The data will not display on the console (pass through only) and sensor management and calibration can only be realized via WS View Plus APP.

**Note:** When optional sensor (s) added, it requires that the console must be powered by USB connection.

Item Number	Number of Channels	Description	Image
WH31	8*	WH31 Multi-channel temperature and humidity sensor	
WN36	WN36 and WH31 share the same 8-channels	WN36 Wireless Floating Pool thermometer	
WH41	4*	PM2.5 Wireless Outdoor Particulate Monitor	
WH43	WH41 and WH43 share the same 4-channels.	PM2.5 Wireless Indoor Particulate Monitor	
WH45	1	PM2.5, PM10 and CO <sub>2</sub> Wireless Indoor Particulate Monitor	
WN51	8*	Soil Moisture Sensor	
WH51	WN51 and WH51 share the same 8-channels.	Soil Moisture Sensor	

WH57	1	Lightning Detector	
WH55	4	Leak Detector	
WH40	1	Rain sensor	
WN34	8*  The WN34S and WN34L share the same 8-channels.	WN34S stainless-steel probe thermometer for soil  WN34L wire probe thermometer for water	
WN35	8	Leaf wetness sensor	

**Table 4: Optional sensors list**

### 5.4 Indoor/Outdoor Thermo-Hygrometer, 8 Channel (optional)

This device supports up to 8 additional thermo-hygrometer sensors (WH31), the data will scroll display on the console and sends the data to Ecowitt.net (requires to set the console uploading to ecowitt.net first).



**Note:** Do not use rechargeable batteries. We recommend fresh alkaline

batteries for outdoor temperature ranges between -4 °F and 140 °F and fresh lithium batteries for outdoor temperature ranges between -40 °C and 60 °C.

1. Remove the battery door on the back of the transmitter(s) by sliding down the battery door, as shown in Figure 错误！未找到引用源。 10.

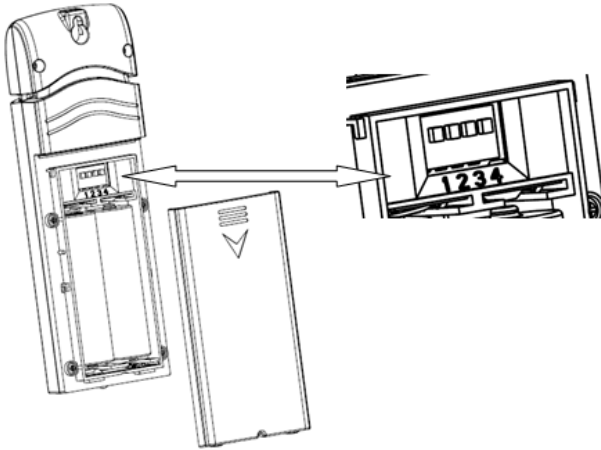

**Figure 10: Battery installation for Multi-channel sensor**

2. **BEFORE** inserting the batteries, locate the dip switches on the inside cover of the lid of the transmitter.
3. **Channel Number:** This item supports up to eight transmitters. To set each channel number (the default is Channel 1), change Dip Switches 1, 2 and 3, as referenced in Figure .
4. **Temperature Units of Measure:** To change the transmitter display units of measure ( °F vs. °C), change Dip Switch 4, as referenced in Figure .

Switch in down position.  Switch in up position.

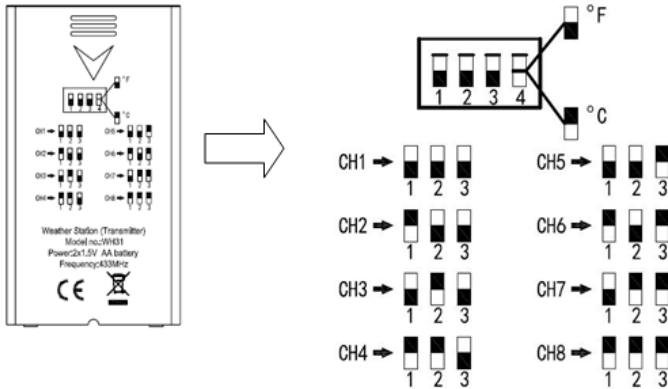

**Figure 11: Dip Switch diagram**

5. Insert two AA batteries.
6. Verify the correct channel number (CH) and temperature units of measure ( °F / °C ) are on the display, as shown in Figure 12 错误! 未找到引用源。 .

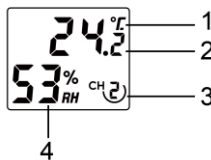

**Figure 12: sensor LCD display**

1. Temperature units ( °C/ °F )	3. Channel number
2. Temperature	4. Relative humidity

7. Close the battery door.
8. Repeat for the additional remote transmitters, verifying each remote is on a different channel.

## 5.5 Best Practices for Wireless Communication

 **Note:** To insure proper communication, mount the remote sensor(s) upright on a vertical surface, such as a wall. **Do not lay the sensor flat.**

Wireless communication is susceptible to interference, distance, walls and metal barriers. We recommend the following best practices for trouble free wireless communication.

**Electro-Magnetic Interference (EMI).** Keep the console several feet away from computer monitors and TVs.

**Radio Frequency Interference (RFI).** If you have other devices operating on the same frequency band as your indoor and/or outdoor sensors and experience intermittent communication between sensor and console, try turning off these other devices for troubleshooting purposes. You may need to relocate the transmitters or receivers to avoid the interference and establish reliable communication. The frequencies used by the sensors are one of (depending on your location): 433, 868, or 915 MHz (915 MHz for United States).

1. **Line of Sight Rating.** This device is rated at 300 feet line of sight (no interference, barriers or walls) but typically you will get 100 feet maximum under most real-world installations, which include passing through barriers or walls.
2. **Metal Barriers.** Radio frequency will not pass through metal barriers such as aluminum siding. If you have metal siding, align the remote and console through a window to get a clear line of sight.

The following is a table of reception loss vs. the transmission medium. Each “wall” or obstruction decreases the transmission range by the factor shown below.

<b>Medium</b>	<b>RF Signal Strength Reduction</b>
Glass (untreated)	5-15%
Plastics	10-15%
Wood	10-40%
Brick	10-40%
Concrete	40-80%
Metal	90-100%

**Table 5: RF Signal Strength reduction**

## 5.6 Display console

The front and back of the display console is shown in Figure13.

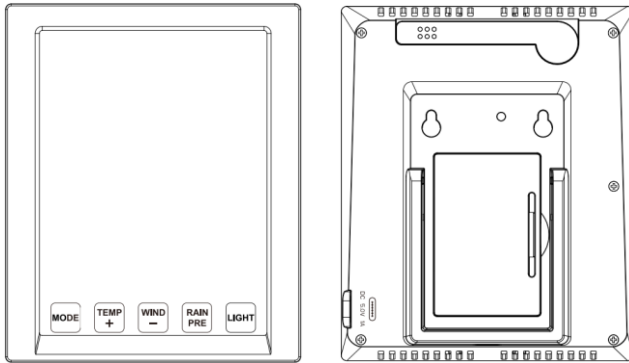

**Figure 13: Display console front and back**

Power on the console as show on Figure 14.

- (1) Insert the 5V AC adaptor into the back of the display console  
 Note: Place the outdoor sensor array about 5 to 10 feet from the display console and wait several minutes for the remote sensors to synchronize with the display console.
- (2) Insert 2 x AA good quality Alkaline or Lithium batteries per Figure 14.
- (3) Wait several minutes for the remote sensors to synchronize with the display console.
- (4) In order to prevent the display console's own temperature rising from affecting the accurate reading of temperature and humidity, the temperature and humidity sensor is placed at the antenna end, away from the station body. Orient the console antenna straight up for accurate indoor temperature and humidity reading.

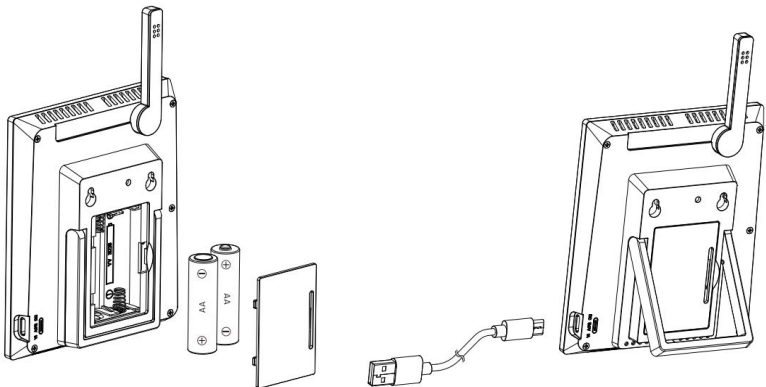

**Figure 14: Battery or USB for display console**



## 6. Display Console Operation

### 6.1 Screen Display

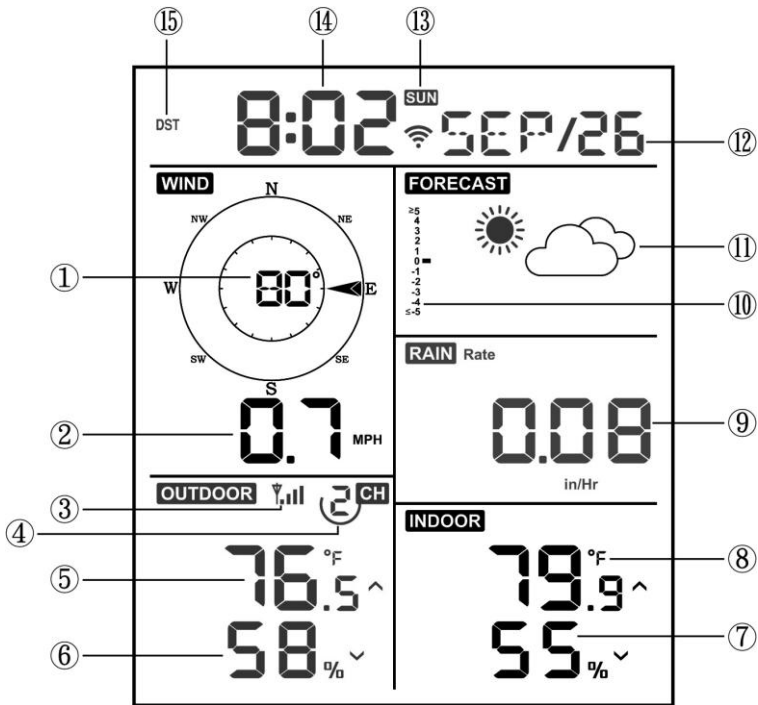

Figure 15: Display Console Screen Layout

1. Wind direction	9. Rainfall
2. Wind speed	10. Barometric Pressure graphic
3. RF signal icon	11. Weather forecast
4. 8 Channel Indoor/Outdoor Thermo-Hygrometer recycle icon (optional)	12. Date
5. Outdoor temperature	13. WIFI signal icon
6. Outdoor humidity	14. Time
7. Indoor humidity	15. Daylight Savings Time (DST)
8. Indoor temperature	

Table 6: Display console detailed items

## 6.2 Initial Display Console Set Up

Insert the batteries to power up the display console.

The unit will show software version and frequency information 2 seconds after power reset.

The unit will turn on all segments of the LCD for 3 seconds after power reset, then the unit will start to register the outdoor channel for 3 minutes.

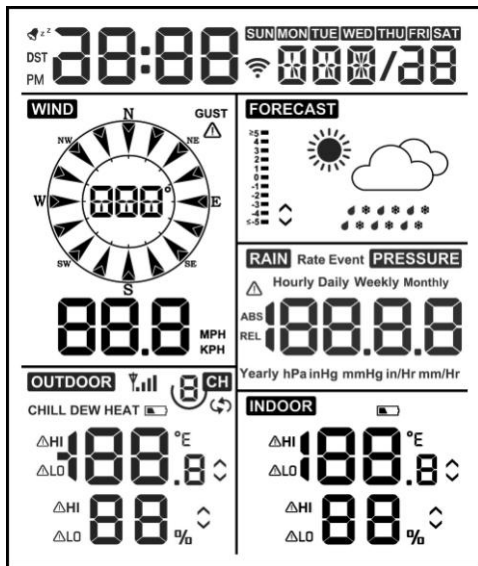

Figure 16

### 6.2.1 Key function

The console has five keys for easy operation

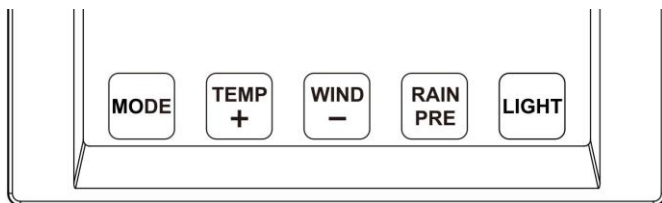

Figure 17

Key	Description
<b>MODE</b>	<ul style="list-style-type: none"> <li>Press and hold for two seconds to enter the Set Mode.</li> <li>Press to switch between Normal Mode, Max Mode, Min Mode, High Alarm Mode, Low Alarm Mode, MAC address display Mode</li> </ul>

<b>TEMP+</b>	<ul style="list-style-type: none"> <li>While the console using battery supply only, press this button to switch display between Outdoor Temperature, Wind Chill, Dew Point, Heat Index. While using DC supply, press the button to switch display between Outdoor Temperature, Chill, Dew Point, Heat Index, 8 channel temperature and humidity (optional), Circle Mode.</li> </ul>
<b>TEMP(+2s)</b>	<ul style="list-style-type: none"> <li>Press and hold 2s will force console to search sensor manually</li> </ul>
<b>WIND -</b>	<ul style="list-style-type: none"> <li>Press to switch between average wind speed and, wind gust.</li> <li>Press and hold for two seconds to switch the wind direction to display in degrees or in letters.</li> </ul>
<b>RAIN/PRE</b>	<ul style="list-style-type: none"> <li>Press and hold for two seconds switch between Rain and Pressure.</li> <li>While in Rain mode, press to switch between Rain Rate, Rain Events, Hourly Rain, Daily Rain, Weekly Rain, Monthly Rain and Yearly Rain</li> <li>While in Pressure mode, press to switch between Relative pressure and Absolute pressure</li> </ul>
<b>LIGHT</b>	<ul style="list-style-type: none"> <li>Press to adjust the LCD backlight brightness (high, medium, low and off) when powered by USB connection</li> <li>Press to exit the SET mode at any time.</li> </ul>
<b>LIGHT(+2S)</b>	<ul style="list-style-type: none"> <li>Wake up WiFi listening when battery powered only</li> </ul>
<b>TEMP+ (and) RAIN PRE</b>	<ul style="list-style-type: none"> <li>Press this two buttons at the same time for 4 seconds to activate BLE function for Wi-Fi configuration (refer to section 8.1.2)</li> </ul>
<b>[MODE] + [LIGHT] + 5s</b>	<ul style="list-style-type: none"> <li>Press Mode and Light button for 5s to make factory default reset.</li> </ul>

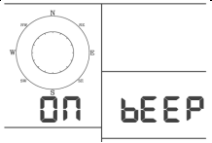
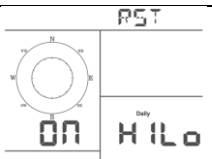

**Table 7: Key function**



### 6.3 Setting mode

**Note:** DST, Time Zone setting can only be programmed via WS View Plus APP. You will need to set time zone info properly if you have the console connected to internet and these setting need to be adjusted for your setup, otherwise console will be synchronized to default setting if you don't setup these parameters on the APP properly.

Press and hold the **MODE** button for two seconds to enter the Set Mode. To proceed to the next setting, press (do not hold) the **MODE** button.

To exit the SET mode at any time, press the **LIGHT** button.

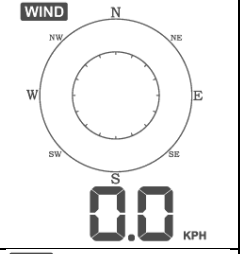
Command	Mode	Settings	Image
[MODE] + 2 seconds	Enter Set Mode, Beep On or Off	Press [TEMP +] or [WIND -] to switch OFF and ON.  This will prevent the beep from sounding when pressing any button.	
[MODE]	Clear Max/Min	Press [TEMP +] or [WIND -] to switch OFF and ON.  When set to ON, the minimum and maximum values reset every day at midnight (00:00).  When set to OFF, the minimum and maximum values must be reset manually.	
[MODE]	12 hour / 24 Hour Format	Press [TEMP +] or [WIND -] to switch hour format between 12 hour and 24-hour format.	
[MODE]	Hour	Press [TEMP +] or [WIND -] to adjust hour up or down.	
[MODE]	Minute	Press [TEMP +] or [WIND -] to adjust minute up or down.	
[MODE]	Year	Press [TEMP +] or [WIND -] to adjust year up or down	
[MODE]	Month	Press [TEMP +] or [WIND -] to adjust month up or down	
[MODE]	Day	Press [TEMP +] or [WIND -] to adjust day up or down	
[MODE]	Pressure Units of Measure	Press [TEMP +] or [WIND -] to change units of measure between hPa, mmHg or inHg.	

[MODE]	Relative Pressure Calibration	Press [TEMP +] or [WIND -] to adjust relative pressure up or down  Reference Section 03 for details on calibration of relative pressure.	
[MODE]	Temperature Units of Measure	Press [TEMP +] or [WIND -] to change temperature units of measure between °F and °C.	
[MODE]	Wind Units of Measure	Press [TEMP +] or [WIND -] to change wind units of measure between km/h, mph,.	
[MODE]	Rain Units of Measure	Press [TEMP +] or [WIND -] to change rain units of measure between in and mm.	
[MODE]	Exit Set Mode		

[MODE] + 2 seconds means to press and hold the MODE button for two seconds.

[MODE] means to press the MODE button.

**Table 8: Set mode sequence and commands summarization**

## 6.4 Barometric Pressure Display

### 6.4.1 Viewing Absolute vs. Relative Pressure

Press and hold [RAIN/PRE] for two seconds switch between Rain and Pressure. While in Pressure mode Press [RAIN/PRE] to switch between absolute and relative pressure

Absolute pressure is the measured atmospheric pressure, and is a function of altitude, and to a lesser extent, changes in weather conditions.

Absolute pressure is not corrected to sea-level conditions.

Relative pressure is corrected to sea-level conditions. For further discussion of relative pressure and calibration, reference Section 0.

### 6.4.2 Rate of Change of Pressure Graph

The rate of change of pressure graphic is shown to the left of the weather forecast icons and signifies the difference between the daily average pressure and the 30-day average (in hPa).



Figure 18

### 6.4.3 Relative Pressure Calibration Discussion

The calibration was set on WS View Plus app. To compare pressure conditions from one location to another, meteorologists correct pressure to sea-level conditions. Because the air pressure decreases as you rise in altitude, the sea-level corrected pressure (the pressure your location would be at if located at sea-level) is generally higher than your measured pressure.

Thus, your absolute pressure may read 28.62 inHg (969 mb) at an altitude of 1000 feet (305 m), but the relative pressure is 30.00 inHg (1016 mb).

The standard sea-level pressure is 29.92 inHg (1013 mb). This is the average sea-level pressure around the world. Relative pressure measurements greater than 29.92 inHg (1013 mb) are considered high pressure and relative pressure measurements less than 29.92 inHg are considered low pressure.

To determine the relative pressure for your location, locate an official reporting station near you (the internet is the best source for real time barometer conditions, such as Weather.com or Wunderground.com), and set your weather station to match the official reporting station.

## 6.5 Rain Display

### 6.5.1 Rain Increments of Measure

Press and hold [RAIN/PRE] for two seconds switch between Rain and Pressure. While in Rain mode press the [RAIN/PRE] to switch between Rain Rate (in/hr), Rain Event, Rain Hourly, Daily Rain, Weekly Rain, Monthly Rain and Yearly Rain.

### 6.5.2 Increments of Rain Definitions

- **Rain rate or hourly rain** is defined as the last 10 minutes of rainfall, multiplied by six (10 minutes x 6 = 1 hour). This is also referred to as instantaneous rain per hour.
- **Rain event** is defined as continuous rain, and resets to zero if rainfall accumulation is less than 1 mm (0.039 in) in a 24-hour period.
- **Daily Rain** is defined as the rainfall since midnight (00:00).
- **Weekly Rain** is defined as the calendar week total and resets on Sunday morning at midnight (Sunday thru Saturday).
- **Monthly Rain** is defined as the calendar month total and resets on the first day of the Month.
- **Yearly Rain** is defined as the total rainfall from January 1 to December 31.

## 6.6 Wind Display

Press the [WIND -] button to switch between average wind speed and, wind gust.

Press and hold the [WIND -] button for two seconds to switch the wind direction to display in degrees or in letters.

- **Wind speed** is defined as the average wind speed in the 16 seconds update period.
- **Wind gust** is defined as the peak wind speed in the 16 seconds update period.

## 6.7 Temperature Display

If temperature is lower than minimum range, the temperature field will display dashes (--.).

If temperature is higher than maximum range, the temperature field will display dashes (--.).

### 6.7.1 Wind Chill, Dew Point and Heat Index Display

Press the [TEMP] button to switch between Outdoor Temperature, Wind Chill, Dew Point, Heat Index.

The device supports up to 8 additional thermo-hygrometer sensors (WH31). If you have the extra sensors, press the [TEMP +] button to switch between Outdoor Temperature, Wind Chill, Dew Point, Heat Index, 8 channel temperature and humidity, Circle Mode

## 6.8 Alarms

### 6.8.1 Viewing High and Low Alarms

To view the high alarm settings, press **MODE** button a third time, and the high alarms will be displayed, as shown in Figure19 **错误! 未找到引用源。** (a).

To view the low alarm settings, press the **MODE** button a fourth time, and the low alarms will be displayed, as shown in Figure19 **错误! 未找到引用源。** (b).

To return to normal mode, press the **LIGHT** button again.



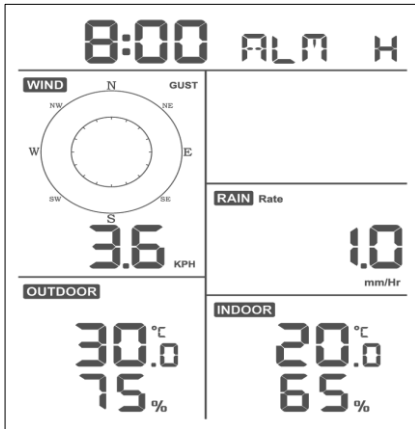

(a)

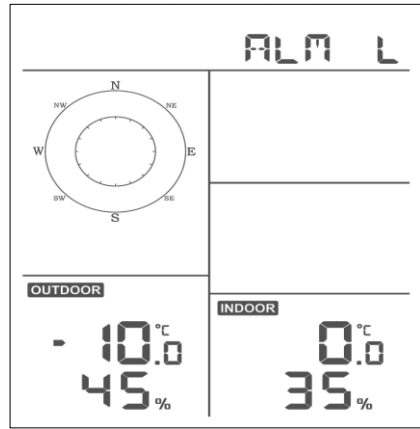

(b)

Figure 19





### 6.8.2 Setting High and Low Alarms





While the High Alarm is displayed as Figure 19(a), press and hold the MODE button for 2 seconds to enter the High Alarm Set Mode.









While the Low Alarm is displayed as Figure 19(b), press and hold the MODE button for 2 seconds to enter the Low Alarm Set Mode.

To save and proceed to the next alarm setting, press the Mode button.

To exit the High Alarm Set Mode at any time, press the LIGHT button.

Command	Mode	Settings
[MODE] + 2 seconds	Enter High Alarm Set Mode, Alarm Hour	<p>Press [TEMP +] or [WIND -] to adjust alarm hour up or down.</p> <p>Press [RAIN/PRE] to turn the time alarm on or off. When the alarm is on, the alarm time icon  will appear.</p>
[MODE]	Alarm Minute	<p>Press [TEMP +] or [WIND -] to adjust alarm minute up or down.</p> <p>Press [RAIN/PRE] to turn the time alarm on. The alarm time icon  will appear.</p> <p>Press [RAIN/PRE] again to turn the time alarm off. The alarm time icon will disappear.</p>
[MODE]	Alarm High Indoor Temperature	<p>Press [TEMP +] or [WIND -] to adjust alarm value up or down.</p> <p>Press [RAIN/PRE] to turn the alarm on.</p> <p>The alarm icon  will appear.</p> <p>Press [RAIN/PRE] to turn the alarm off. The alarm icon will disappear.</p>
[MODE]	Alarm High Indoor Humidity	<p>Press [TEMP +] or [WIND -] to adjust alarm value up or down.</p> <p>Press [RAIN/PRE] to turn the alarm on.</p> <p>The alarm icon  will appear.</p> <p>Press [RAIN/PRE] to turn the alarm off. The alarm icon will disappear.</p>

[MODE]	Alarm High Outdoor Temperature	<p>Press [TEMP +] or [WIND -] to adjust alarm value up or down.</p> <p>Press [RAIN/PRE] to turn the alarm on.</p> <p>The alarm icon  will appear.</p> <p>Press [RAIN/PRE] to turn the alarm off. The alarm icon will disappear.</p>
[MODE]	Alarm High Outdoor Humidity	<p>Press [TEMP +] or [WIND -] to adjust alarm value up or down.</p> <p>Press [RAIN/PRE] to turn the alarm on.</p> <p>The alarm icon  will appear.</p> <p>Press [RAIN/PRE] to turn the alarm off. The alarm icon will disappear.</p>
[MODE]	Alarm High Wind Gust	<p>Press [TEMP +] or [WIND -] to adjust alarm value up or down.</p> <p>Press [RAIN/PRE] to turn the alarm on.</p> <p>The alarm icon  will appear.</p> <p>Press [RAIN/PRE] to turn the alarm off. The alarm icon will disappear.</p>
[MODE]	Alarm High Rain Rate	<p>Press [TEMP +] or [WIND -] to adjust alarm value up or down.</p> <p>Press [RAIN/PRE] to turn the alarm on.</p> <p>The alarm icon  will appear.</p> <p>Press [RAIN/PRE] to turn the alarm off. The alarm icon will disappear.</p>

[MODE]	Alarm Low Indoor Temperature	<p>Press [TEMP +] or [WIND -] to adjust alarm value up or down.</p> <p>Press [RAIN/PRE] to turn the alarm on.    The alarm icon  will appear.</p> <p>Press [RAIN/PRE] to turn the alarm off.  The alarm icon will disappear.</p>
[MODE]	Alarm Low Indoor Humidity	<p>Press [TEMP +] or [WIND -] to adjust alarm value up or down.</p> <p>Press [RAIN/PRE] to turn the alarm on.    The alarm icon  will appear.</p> <p>Press [RAIN/PRE] to turn the alarm off.  The alarm icon will disappear.</p>
[MODE]	Alarm Low Outdoor Temperature	<p>Press [TEMP +] or [WIND -] to adjust alarm value up or down.</p> <p>Press [RAIN/PRE] to turn the alarm on.    The alarm icon  will appear.</p> <p>Press [RAIN/PRE] to turn the alarm off.  The alarm icon will disappear.</p>
[MODE]	Alarm Low Outdoor Humidity	<p>Press [TEMP +] or [WIND -] to adjust alarm value up or down.</p> <p>Press [RAIN/PRE] to turn the alarm on.    The alarm icon  will appear.</p> <p>Press [RAIN/PRE] to turn the alarm off.  The alarm icon will disappear.</p>
[MODE]	Exit alarm settings mode.	

[MODE] + 2 seconds means to press and hold the MODE button for 2 seconds.

[MODE] means to press the MODE button.

Table 9: Alarm mode sequence and commands summarization

## 6.9 Max/Min Mode

### 6.9.1 Viewing Max/Min Values

To view the max value, press the **MODE** button, and the max values will be displayed, as shown in Figure 20(a). To clear the max values, press and hold the **MODE** button while the max values are displayed.

To view the min value, press the **MODE** button again, and the min values will be displayed, as shown in Figure 20 (b). To clear the min values, press and hold the **MODE** button while the min values are displayed.

To return to normal mode, press the **LIGHT** button.

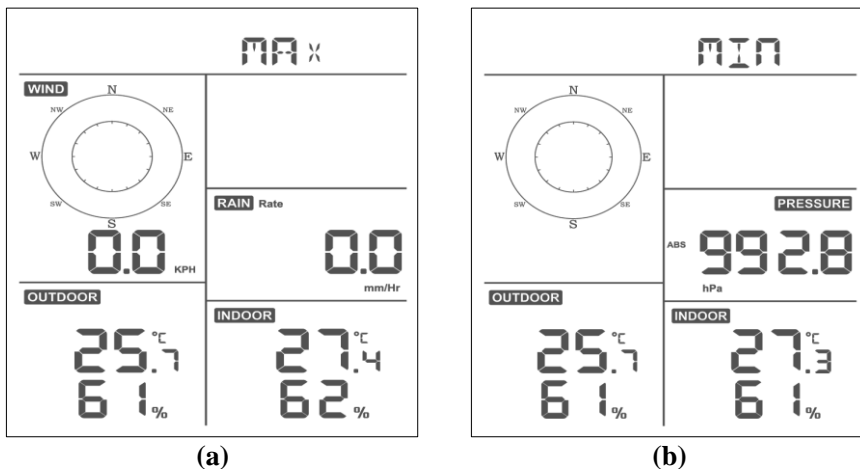

Figure 20

#### 6.9.1.1 Display Wind Chill, Heat Index vs. Dew Point Max/Min Values

While the **max values** are displayed as outlined in Figure 20(a), press the **TEMP+** button once to view the wind chill, twice to view the dew point, third to view the heat index and a fourth time to return to outdoor temperature.

While the **min values** are displayed as outlined in Figure 20(b), press the **TEMP+** button once to view the wind chill, twice to view the dew point, third to view the heat index and a fourth time to return to outdoor temperature.

#### 6.9.1.2 Display Wind Speed vs. Wind Gust Max Values

While the **max values** are displayed as outlined in Section 0, press the **WIND-**

button once to view the max wind gust, and twice to return to wind speed.

### 6.9.1.3 Display Hourly Rain, Rain Rate

While the **max values** are displayed as outlined in Section 0, press the **RAIN** button once to view the max hourly rain, twice to view the rain rate.

### 6.9.1.4 Display Absolute and Relative Pressure Min and Max Values

While the **max values** are displayed as outlined in Section 0, press and hold the **RAIN/PRE** button for two seconds to enter pressure display, press **RAIN/PRE** button to switch between Relative pressure and Absolute pressure.

While the **min values** are displayed as outlined in Section 0, press and hold the **RAIN/PRE** button for two seconds to enter pressure display, press **RAIN/PRE** button to switch between Relative pressure and Absolute pressure

To return to normal mode, press the **LIGHT** button.

## 6.10 Resynchronize Wireless Sensor

While in outdoor TH/wind chill/dew point/heat index display mode press **TEMP+** button for 5 seconds, and the console will re-register the outdoor sensor array

While in 1-8 channel Thermo-hygro sensor display mode press **TEMP+** button for 5 seconds, and the console will re-register the current channel outdoor sensor.

While in Circle Mode press **TEMP+** button for 5 seconds, and the console will re-register the sensor array and 1-8 channel sensors.



## 6.11 Backlight Operation

Press **LIGHT** button for 2s, will wake up Wi-Fi chip from power saving state, the date display will turn to show “**WAK**”, saying that at battery power supply state, the Wi-Fi existed power saving mode, and it is very useful when Live Data feature need to be activated on WS View Plus app for live data reference, as during Wi-Fi power saving mode, the system is not responding to WS View Plus app commands quickly.

### 6.11.1 With USB cable (included)

The backlight can only be continuously on when the console display is powered on with the USB cable.

Press the LIGHT button to adjust the brightness between High, Middle, Low and Off.

### 6.11.2 Without USB Power supplied

Press any button briefly to turn on the backlight temporarily for 15 seconds.

## 6.12 Tendency Arrows

Tendency arrows allow you to quickly determine if temperature or pressure are rising and falling in a three-hour update period, updated every 30 minutes.

Table 10 defines the conditions for rising and falling pressure every 3 hours.

Tendency indicators	Condition	Humidity Change per 3 Hours	Temperature Change per 3 Hours
^	Rising	Rising > 3%	Rising > 1 °C / 2 °F
None	Steady	Change ≤ ±3%	Change ≤ ± 1 °C / 2 °F
v	Falling	Falling > 3%	Falling > 1 °C / 2 °F

Table 10: Tendency indicators summarization

## 6.13 Wireless Signal Quality Indicator

The wireless signal strength displays reception quality. If no signal is lost, the signal strength indicator will display four bars. If the signal is lost once, three bars will be displayed, as shown in Table 11.





Four Bars	Three Bars
	
No signal loss	Lost signal once

Table 11

## 6.14 Weather Forecasting

The five weather icons are Sunny, Partly Cloudy, Cloudy, Rainy, Stormy and Snowy.

The forecast icon is based on the rate of change of barometric pressure. Please allow at least **one month** for the weather station to learn the barometric pressure over time.

Sunny	Partly Cloudy	Cloudy	Rainy	Snowy
				
Pressure increases for a sustained period of time	Pressure increases slightly, or initial power up	Pressure decreases slightly	Pressure decreases for a sustained period of time	Pressure decreases for a sustained period of time and temperature is below freezing

**Table 12: Weather forecasting summarization**

### Note:

When the pressure decreases dramatically, the rainy icon will flash to indicate stormy.

When the pressure decreases dramatically and the temperature is below freezing, the snowy icon will flash to indicate blizzard.

### 6.14.1 Storm Alert

If there is a rapid drop in barometric pressure, the forecast icon will flash.

### 6.14.2 Weather Forecasting Description and Limitations

In general, if the rate of change of pressure increases, the weather is generally improving (sunny to partly cloudy). If the rate of change of pressure decreases, the weather is generally degrading (cloudy, rainy). If the rate of change is relatively steady, it will read partly cloudy.



The reason the current conditions do not match the forecast icon is because the forecast is a prediction 24-48 hours in advance. In most locations, this prediction is only 70% accurate and it is a good idea to consult the National Weather Service for more accurate weather forecasts. In some locations, this prediction may be less or more accurate. However, it is still an interesting educational tool for learning why the weather changes.

The National Weather Service (and other weather services such as Accuweather and The Weather Channel) have many tools at their disposal to predict weather conditions, including weather radar, weather models, and detailed mapping of ground conditions.

## 6.15 MAC address display

Press the MODE button five times to view MAC address.

For example the MAC address as shown below is 88:4A:18:13:89:77

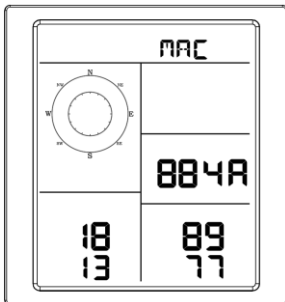

With your obtained MAC address, register your device on the Ecowitt service or customized website.

## 7. Specification:

### Outdoor data

Transmission distance in open field	: 100M/300FT
Frequency	: 915/868/433MHz depending on location (North American: 915MHz; Europe: 868MHz; Other areas: 433MHz)
Temperature range	: -40°C--60°C (-40°F to +140°F)
Accuracy	: +/- 1 °C

Resolution	:	0.1°C
Measuring range rel. humidity	:	1% ~ 99%
Accuracy	:	+/- 5%
Rain volume display	:	0 – 9999mm (show --- if outside range)
Accuracy	:	+ / - 10%
Resolution	:	0.1mm (if rain volume < 1000mm) 1mm (if rain volume > 1000mm)
Wind speed	:	0-180km/h (0~100mph) (show --- if outside range)
Accuracy	:	+/- 1m/s (wind speed < 5m/s) +/-10% (wind speed > 5m/s)
Measuring interval thermo-hygro sensor	:	16 s

### **Indoor data**

Indoor temperature range	:	0°C--50°C (32°F to + 122°F) (show --- if outside range)
Resolution	:	0.1°C
Measuring range rel. Humidity	:	1% ~ 99%
Resolution	:	1%
Measuring range air pressure	:	700-1100hPa (20.67-32.5inHg)
Accuracy	:	+/-3hpa
Resolution	:	0.1hPa (0.01inHg)
Alarm duration	:	120s
Measuring interval indoor data	:	60s

### **Power consumption**

- Base station : 5V DC (USB to 2.5\*0.7mm DC 5V power plug connector cable included)
- Base station : 2 x AA batteries (not included)
- Remote sensor: 2x AA batteries (not included)

## 8. Live Internet Publishing

Your console is capable of sending your sensor data to select internet-based weather services. The supported services are shown in the table below:

Hosting Service	Website	Description
Ecowitt Weather	<a href="https://www.ecowitt.net">https://www.ecowitt.net</a>	Ecowitt is a new weather server that can host a bunch of sensors that other services don't support.
Weather Underground	WeatherUnderground.com	Weather Underground is a free weather hosting service that allows you to send and view your weather station data real-time, view graphs and gauges, import text data for more detailed analysis and use iPhone, iPad and Android applications available at Wunderground.com. Weather Underground is a subsidiary of The Weather Channel and IBM.
Weather Cloud	WeatherCloud.net	Weathercloud is a real-time weather social network formed by observers from around the world
Weather Observation Website (WOW)	<a href="http://wow.metoffice.gov.uk/">http://wow.metoffice.gov.uk/</a>	WOW is a UK based weather observation website. WOW allows anyone to submit their own weather data, anywhere in the world.
Customized Website		Supports uploading to your customized website, if the website has the same protocol with Wunderground or Ecowitt

**Table 13: Supported weather services**

To send weather data to these services you must configure console to be connected to your Wi-Fi router for internet access.

Note: If you own a dual band router (2.4 GHz and 5.0 GHz), make sure you connect to the 2.4 GHz band, otherwise it will fail to connect the weather station to WiFi.

# 8.1 Wi-Fi Configuration

## Method A:

Install **WS View Plus** app. Then follow up the instruction as the App will walk you through the SETUP Process

**Remark:** We recommend method A to be used in the first place. Please follow the App's instruction to complete account registration and device provision. If method A is not working for you, please follow method B to start

Note: When prompted “Allow WS View Plus to access your location?” choose” Allow While Using App.” If you do not select this option, your phone will not connect to the weather station.

The following instructions will generally show screen shots side by side:



1) Press  button



2) Select the device you have from the device list, then press **Next**



3) Follow the prompts, tick the box to confirm “completed operation”, press **Next**.



4)

Choose the device named “WN19XX-WIFI” followed by four characters.

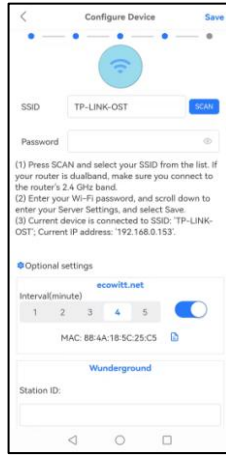

5)

Press Scan and select you **SSID** from the list, then enter your WiFi **password** and press **Next**.



6)

Start to connect your phone to the weather station “WN19XX-WIFI” to your router. Configure successfully 100%, Press OK.

Once completed successfully, your device ID, IP address and MAC address will be displayed on the **My Device/Device List** page. Tap the device to enter “Live Data” screen.

On the “Live Data” screen, press the “More” button in the upper right and select “Weather Services” from the menu.

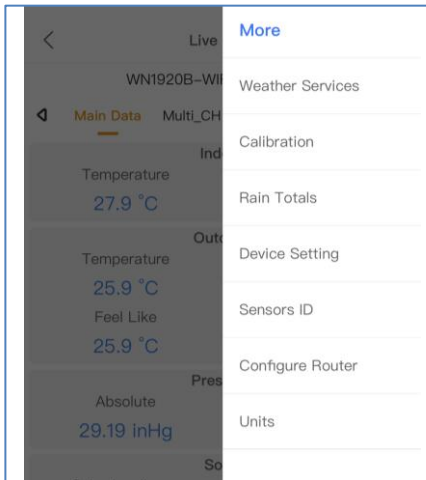

Navigate to the weather service you wish to configure by pressing “Next” and enter the appropriate data.

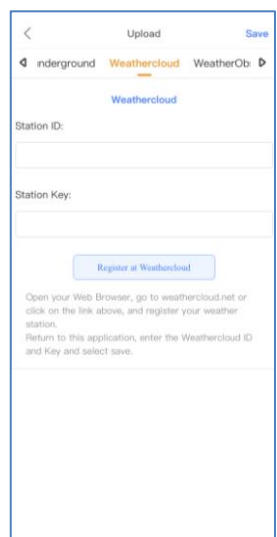
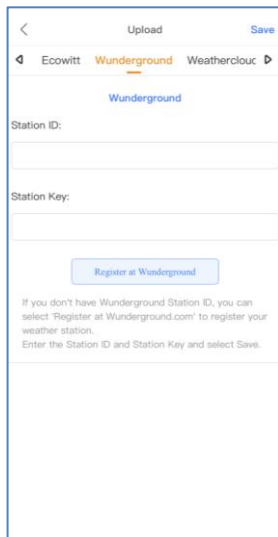
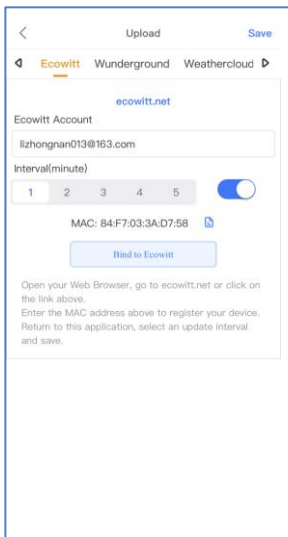

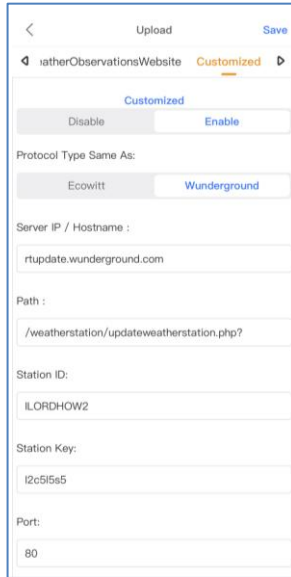
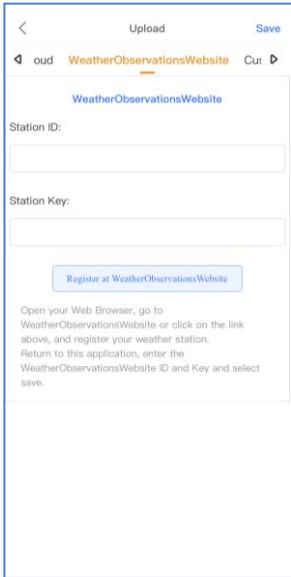

**Live Data** is obtained by the mobile app by connecting directly to the display console. It will display all the sensors data received. This can only happen when your mobile device and display console are connected to the same Wi-Fi network. It will then show up after you select “Device List” from the main settings menu. If your mobile device is in another network, no device(s) will show up in this list and you will not be able to select a device for displaying the “Live Data” screen.



## Method B:

1. Connect the display console power jack to AC power with the power adapter.
2. Go to your computer’s or phone’s Network Settings page, find WN1920 AP (**WN19XX-WIFIXXXX**) in Network Settings page or WLAN page.

3. open a browser, navigate to the following IP address 192.168.4.1 you will enter the login screen

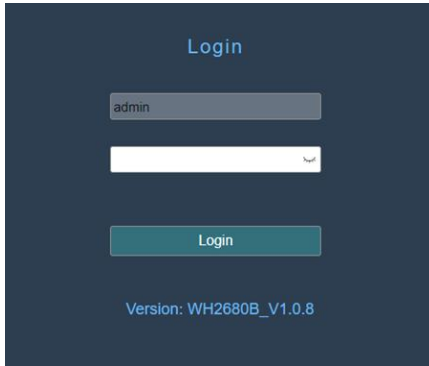

No password is required for the first login. However, if you have set your password on the Device Setting page after logging in, you will need to enter your password the next time you log in. Also you can leave the password unset.

The “Weather Server” screen provides a selection of Weather sever to upload.

## 8.2.2 Connect to Weather Server on PC

### 1) Connect Local Network

Press Scan and select your **SSID** from the list, then enter your **WIFI password** and press **Apply**.

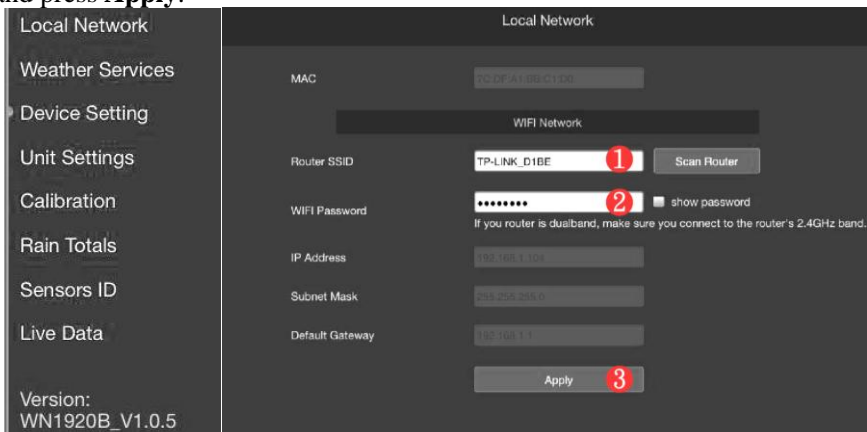

Note: After Apply, check whether the **IP Address** is retrieved



## 2) Set up Weather Services

Your console is capable of sending your sensor data to select internet-based weather services: [ecowitt.net](http://ecowitt.net), [Wunderground.com](http://Wunderground.com), [weathercloud.net](http://weathercloud.net), [wow.metoffice.gov.uk](http://wow.metoffice.gov.uk) and Customized Website. User need to register at the select website to get the station ID (or MAC address) and password.

Here you will enter the Station ID and Station key and the interval to send data and click save.

The screenshot shows a configuration window titled "Weather Services" with a dark background. It is divided into several sections, each with a header bar:

- Ecowitt.net**: Includes a dropdown menu for "Interval (minutes)" set to "1" and a link for "Ecowitt.net". Below it, the "MAC" address is displayed as "40 F5 20 08 7F 72".
- Wunderground**: Contains two input fields for "Station ID" and "Station Key".
- Weathercloud**: Contains two input fields for "Weathercloud ID" and "Weathercloud Key".
- WeatherObservationsWebsite**: Contains two input fields for "Station ID" and "Station Key".
- Customized**: Includes a "Customized" toggle with "Disable" and "Enable" radio buttons (both unselected). Below it, a "Protocol Type Same As" section has "Ecowitt" and "Wunderground" radio buttons (both unselected). Further down are input fields for "Server IP / Hostname", "Path" (containing "/data/report/"), "Port" (containing "80"), and "Upload Interval" (containing "60" with "Seconds" to its right).

A "Save" button is located at the bottom center of the form.

## 8.2 Ecowitt Weather

It's recommended to use the Ecowitt Weather server to monitor and record your sensors' data. Configure as follows:

- On the ecowitt.net uploading page, enable the ON button (displayed blue) and set the uploading interval time.
- Press Save on the page.
- Press “Bind to Ecowitt” and finish the registration on the page.

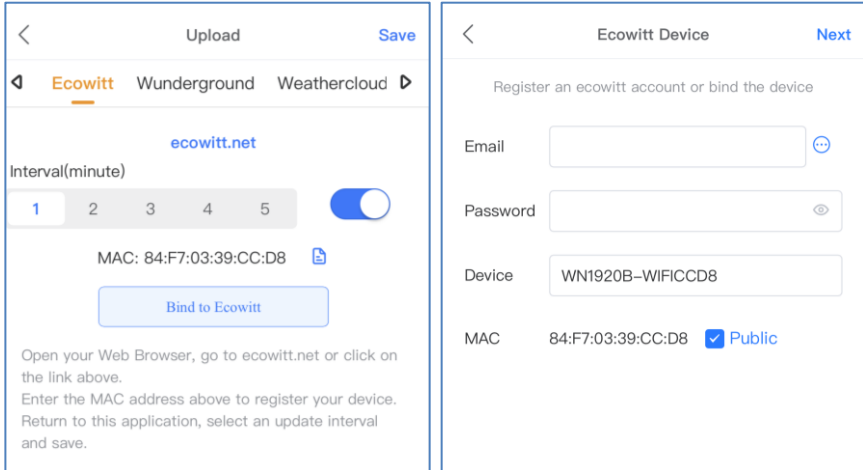

- Enter your email address.
- Set a password for your ecowitt account
- Press Next(Enter the captcha you received from your email box and press submit.)
- It will jump to the ecowitt.net dashboard and display the sensor data within several minutes.

**Note:**

If you could not receive the captcha from your email box, please check the spam.

It only supports setting the units and language on the WS View Plus app. To use the full settings, please visit the ecowitt website on your browser or on a computer.

If you could not register on the WS View Plus app, please go to the website to register and add the device.

**Viewing data on ecowitt.net**

You can observe your sensor’s data by using the ecowitt.net web site. You will use a URL like this one, where your station ID replaces the text “STATIONID”.

<https://www.ecowitt.net/home/index?id=STATIONID>

Note: If you want to share your station data with other users, you may use the Share option under the Menu to create a share link.

It will show a page such as this, where you can look at today's data and historical data as well.

## Dashboard



## Graph display



# List display

6:37 PM Thu Aug 22 ecowitt.net 73%

Jakon GW1000  
Reported 13 seconds ago

448347061

Bar chart icon | Daily | Aug/22/2019

Time	Temperature (°C)	Humidity(%)	Dew Point(°C)	Feels Like(°C)	Temperature (°C)	Humidity(%)	Absolute(hPa)	Relative(hPa)	Wind Speed(m/s)	Wind Gust(m/s)	Wi Dir
2019-08-22 18:30	31.3	77	26.8	40.9	31.8	72	997.8	997.8	1.0	2.0	4
2019-08-22 18:25	31.5	77	26.9	41.3	31.8	71	997.7	997.7	1.1	1.5	2
2019-08-22 18:20	31.5	76	26.8	41.2	31.9	71	997.8	997.8	0.8	1.5	3
2019-08-22 18:15	31.6	76	26.9	41.4	32.0	71	997.7	997.7	0.9	2.0	2
2019-08-22 18:10	31.7	75	26.8	41.5	32.0	71	997.6	997.6	0.7	2.0	3
2019-08-22 18:05	31.8	75	26.8	41.6	32.0	71	997.6	997.6	0.8	2.6	2
2019-08-22 18:00	31.9	74	26.7	41.6	32.1	71	997.5	997.5	1.1	3.1	8
2019-08-22 17:55	31.9	75	26.9	41.9	32.0	70	997.5	997.5	1.1	3.6	7
2019-08-22 17:50	32.1	74	26.9	42.4	32.1	70	997.4	997.4	1.0	2.0	5
2019-08-22 17:45	32.2	74	27.0	42.6	32.1	70	997.4	997.4	1.7	2.6	1
2019-08-22 17:40	32.3	74	27.1	42.9	32.2	70	997.1	997.1	0.6	2.0	2
2019-08-22 17:35	32.5	73	27.0	43.1	32.2	69	997.3	997.3	0.9	2.6	6
2019-08-22 17:30	32.7	72	27.1	43.6	32.2	69	997.4	997.4	0.5	1.5	5

# Weather Map

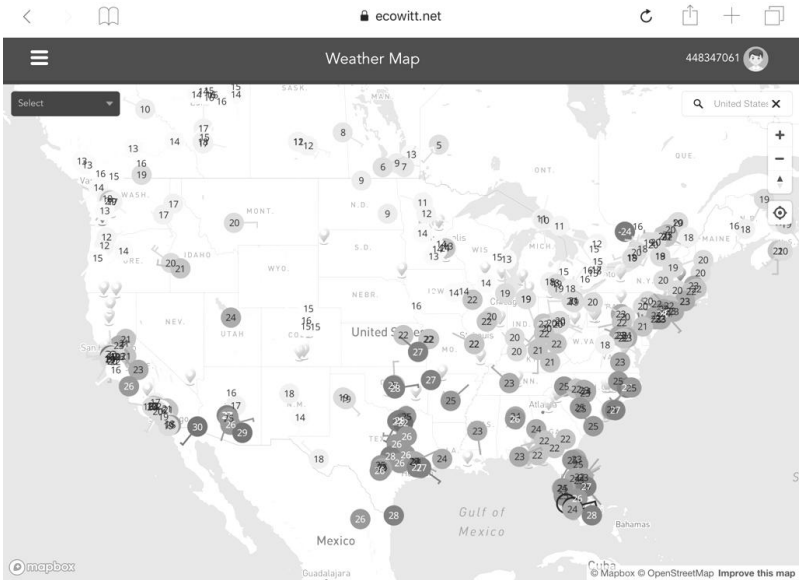

# Email Alerts

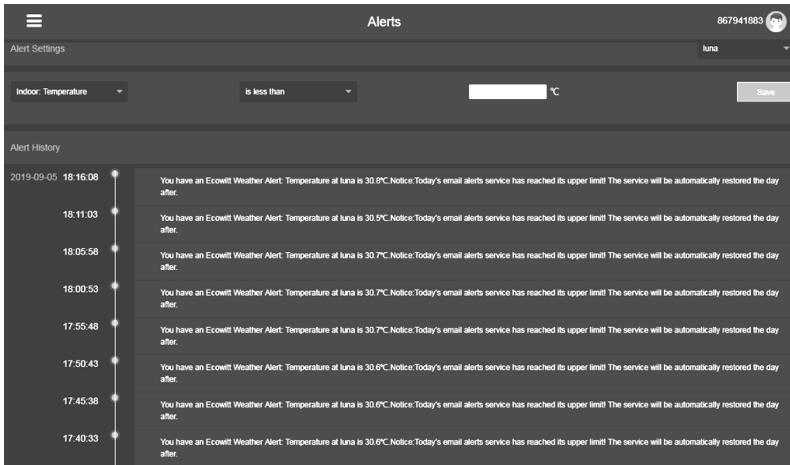

## 9. Registering WeatherUnderground.com through the PC or Mac

If you have not already done setup for wunderground.com during the Wi-Fi setup, you can do so later. Perform the following steps:

1. Visit Wunderground.com and select the **Join** link at the top of the page and sign up.

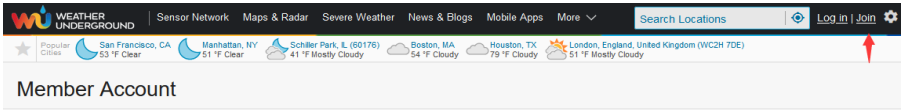

## Join Weather Underground

- Choose real-time alerts for your city.
- Choose adding your webcam or personal weather station.
- You can delete your account at any time from your member settings.

The Weather Company needs your email to create your Weather Underground account.

Email

Password (5-30 characters)  [Show](#)

Confirm New Password:

I agree to the [Terms of Use](#)

[Sign up for free](#)

Already have an account? [Sign in](#)

## 2. Click My Profile and select My Devices to register your station

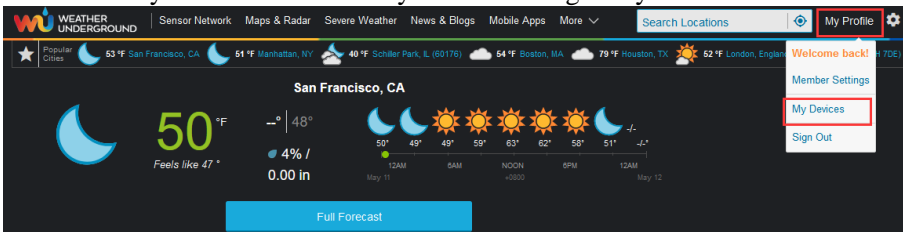

## 3. Select Add New Device.

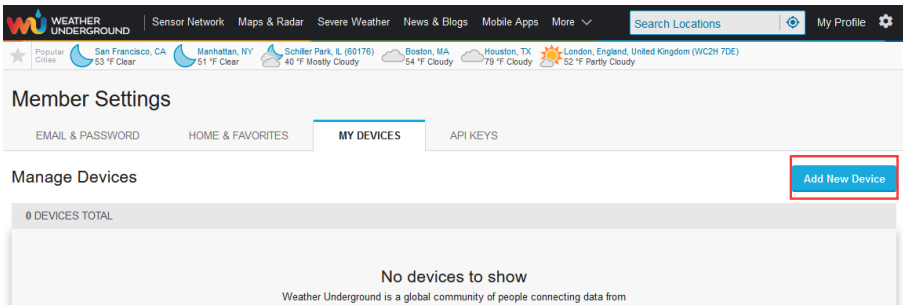

## 4. Find Personal Weather Station. Select 'other' and click 'Next'.

## Add a New Device

TYPE LOCATION DETAILS DONE

Select a Device Type

25%

The screenshot shows the 'Add a New Device' screen with the 'TYPE' tab selected. A progress bar at the top indicates 25% completion. Two main panels are visible: 'Personal Weather Station' and 'Outdoor Webcam'. The 'Personal Weather Station' panel has a dropdown menu open, showing a list of device models. The 'Next' button is highlighted with a red box. The 'Outdoor Webcam' panel has a 'Select camera type' dropdown and a 'Next' button. A 'Cancel' button is also present in the 'Personal Weather Station' panel. The background shows a dark interface with various links like 'Terms of Use', 'Privacy Policy', and 'Data Vendors'.

5. Select 'Address' or 'Manual' option, and find your local position. Press 'Next'.

## Add a New PWS

TYPE LOCATION DETAILS DONE

Set Device Name & Location

50%

The screenshot shows the 'Set Device Name & Location' screen with the 'LOCATION' tab selected. A progress bar at the top indicates 50% completion. Under 'Device Location:', there are two radio buttons: 'Address' and 'Manual'. The 'Manual' button is selected and highlighted with a red box. Below the radio buttons is a text input field containing the coordinates '48.101,11.363', which is also highlighted with a red box. Below the input field, there is a confirmation message: 'Your Location has been verified and added!'. Below this message, the following information is displayed: 'Elevation: 1841 ft.', 'Lat, Lon: 48.101, 11.363', 'Neighborhood: Krailing', and 'Time Zone: Europe/Berlin'. At the bottom, there are 'Back' and 'Next' buttons, with the 'Next' button highlighted by a red box.

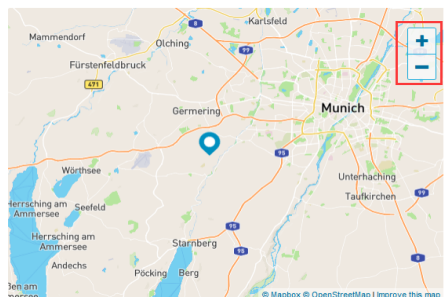

6. This time you will be asked details about your weather station. Go ahead and fill out the form.

## Add a New PWS

TYPE LOCATION **DETAILS** DONE

### Tell Us More About Your Device

75%

**Name:(Required)**

**Surface Type:**

**Elevation:(Required)**

**Associate Webcam:**

**Device Hardware:(Required)**

**Height Above Ground:**

#### You Make Our Forecasts More Accurate, We Respect Your Privacy

Contribute to the Weather Underground community by sharing some information about yourself and your sensor. We use this information to manage your account and to improve the experience from the Weather Underground community. We may also share certain data for commercial purposes, such as your sensor location.

[Learn more about how we take your privacy seriously](#)

**(Required)**  
 I Accept  I Deny

**Email Preferences:**  
 I would like to receive PWS notifications.

Back

Next

## 7. After completing the weather station, you will see station ID and key/password.

### Add a New PWS

TYPE LOCATION DETAILS **DONE**

### Registration Complete!

100%

Congratulations! Your personal weather station is now registered with Weather Underground.

Enter the information below to your weather station software.

Your PWS  
Station ID:   
Station Key:

Copy credentials



**Note:** Your station ID will have the form: KSSCCCC###, where K is for USA station (I for international), SS is your state, CCCC is your city and ### is the station number in that city.

In the example above, KAZPHOEN424 is in the USA (K), State of Arizona



(AZ), City of Phoenix (PHOEN) and #424.

## Viewing your Data on Wunderground.com

You can also observe your weather station's data by using the wunderground.com web site. You will use a URL like this one, where your station ID replaces the text "STATIONID":

<http://www.wunderground.com/personal-weather-station/dashboard?ID=STATIONID>

It will show a page such as this, where you can look at today's data and historical data as well:

**(\*) Darwin (+9:30 Zone) Test Station IDARWIN13** About this PWS Report Comments  
 Forecast for Darwin, AU > -12.460 130.841 > 66 ft

**PWS Data** PWS Widgets WunderStation My PWS

PWS viewed 3 times since July 1, 2018

Satellite Webcam Icon

Mapbox © Mapbox © OpenStreetMap | Improve this map

Low Clouds High Clouds  
Warm Cold

View WunderMap

Current Conditions Station reported 0 second ago

# 78.4 °F

Feels Like 78.4 °F

Dew Point: **66.2 °F**

Humidity: **66%**

Precip Rate: **0.00 in/hr**

Precip Accum: **0.00 in**

Pressure: **29.80 in**

UV: **0.0**

Solar: **0 w/m<sup>2</sup>**

Soil Moisture: **--**

Soil Temp: **--**

Leaf Wetness: **--**

7:08 AM 6:33 PM

☾ Waning Gibbous | 50% Illuminated

Weather History for Darwin, [IDARWIN13]

◀ Previous Daily Month Jul 6 2018 View Next ▶

**Summary July 6, 2018**

	High	Low	Average		High	Low	Average
Temperature	82.4 °F	77.4 °F	79.9 °F	Wind Speed	13 mph	--	12 mph
Dew Point	73.8 °F	64.6 °F	70.1 °F	Wind Gust	14 mph	--	--
Humidity	79%	63%	70%	Wind Direction	--	--	West
Precipitation	0 in	--	--	Pressure	29.67 in	29.59 in	--

There are also some very useful mobile apps. The URLs provided here go to the Web version of the application pages. You can also find them directly from the iOS or Google Play stores:

- WunderStation:** iPad application for viewing your station's data and graphs  
<https://itunes.apple.com/us/app/wunderstation-weather-from-your-neighborhood/id906099986>

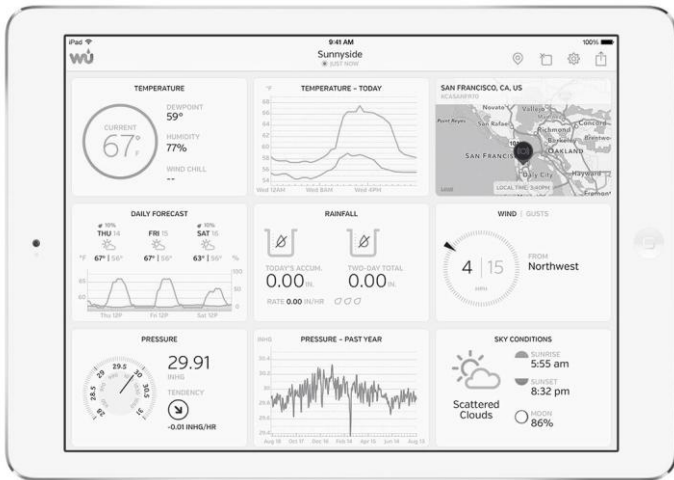

- WU Storm:** iPad and iPhone application for viewing radar images, animated wind, cloud coverage and detailed forecast, and PWS station data  
<https://itunes.apple.com/us/app/wu-storm/id955957721>

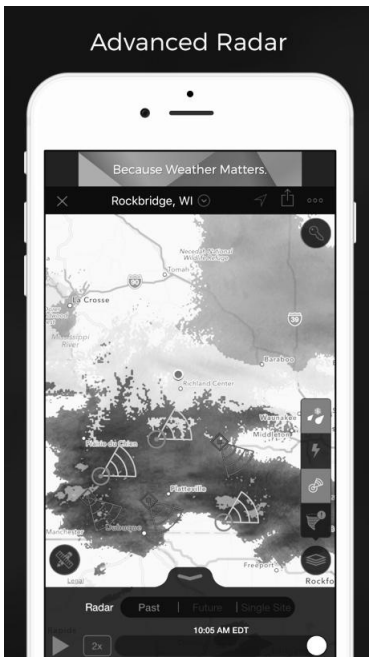

- Weather Underground: Forecast:** iOS and Android application for forecasts

<https://itunes.apple.com/us/app/weather-underground-forecast/id486154808>

<https://play.google.com/store/apps/details?id=com.wunderground.android.weather&hl=en>



Current conditions at a glance



Geek out on data



Interactive radar and satellite

- PWS Weather Station Monitor: View weather conditions in your neighborhood, or even right in your own backyard. Connects to wunderground.com

<https://itunes.apple.com/us/app/pws-weather-station-monitor/id713705929>

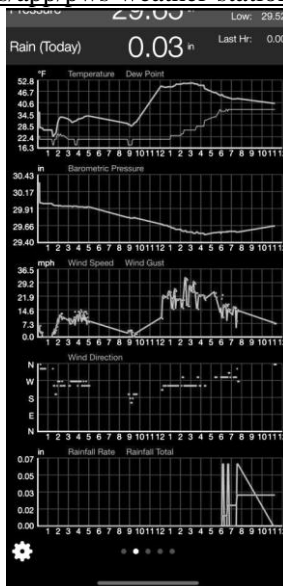
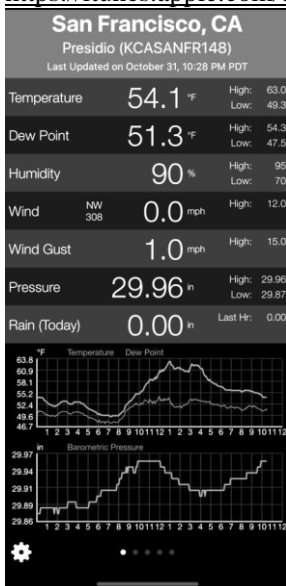

## 10. Other functions on WS View Plus

### 10.1 WU Dashboard vs Live Data

You should be aware that the information presented on weatherunderground.com represents the latest as seen by WU (from the last successful upload), and may not be identical what is on your live data screen!

Here is a short explanation of differences:

**Live Data** is obtained by the mobile app by connecting directly to the gateway. This can only happen when your mobile device and gateway are connected to the same Wi-Fi network. It will then show up after you select “Device List” from the main settings menu. If your mobile device is in another network, no device(s) will show up in this list and you will not be able to select a device for displaying the “Live Data” screen.

**WU Dashboard** shows the data obtained from WU server. This requires that your mobile device can reach the Internet and therefore this is possible even when you are not on your home Wi-Fi network, such as when using cellular data.

Note: When the Wi-Fi configuration done, the **WU Dashboard** will be the default interface on the WS View Plus app. Use the **Menu** button can go to the **Device List** interface – select your device to jump to **Live Data** interface.

### 10.2 Manage Wunderground

You can add or delete WU Station ID by selecting “Manage Wunderground” on the submenu:

WU Stations		Add
I44JIUXI35		Delete
I44JIUXI28		Delete
I44JIUXI60		Delete
I44JIUXI74		Delete
IFJELL37		Delete
I44JIUXI65		Delete
I44JIUXI71		Delete
IU5E7FU414		Delete
KCAMOUNT191		Delete
I44JIUXI36		Delete
IU5E7FU429		Delete

### 10.3 Settings

You can set your desired display units or default home page for the app by selecting “Settings” on the submenu:

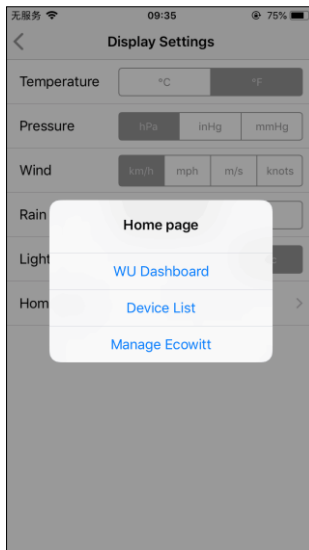

### 10.4 Manage Ecowitt

Once you created your ecowitt account successful on the WS View

Plus app, you may select “Manage Ecowitt” on the submenu to manage your device.

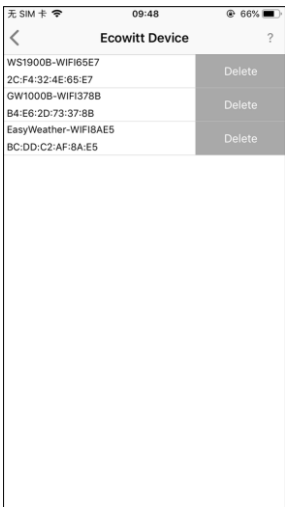

You may view your weather station data by pressing your device on this screen:

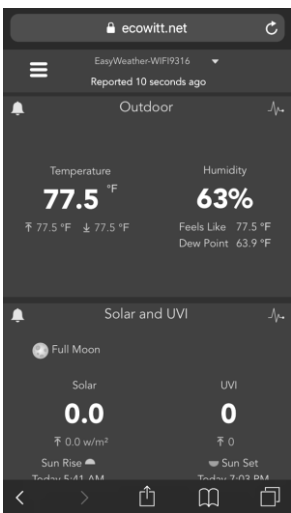

## 10.5 Direct Connection & Test Mode

In case the Device List shows blank after the Wi-Fi configuration, press the “+” button at the upper right corner (for iOS device) or select Direct Connection under the Menu (for Android device):

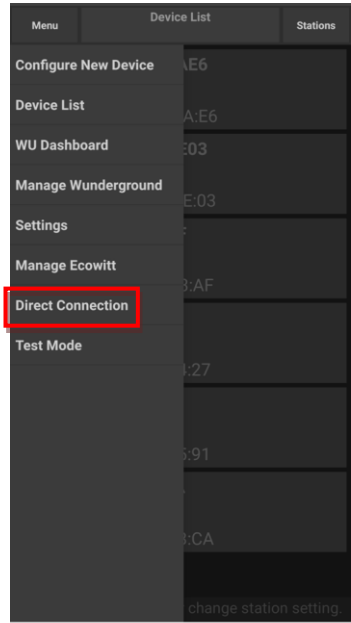

or

Find the IP address of the gateway and enter it on the app. The IP address can be found at the list of the connected devices of your router:

**Direct Connection**

In case the device is not showing up in device list page after router configuration is done, you may enter the IP address( to be found on your router for this device) manually and continue for weather service setup , view live data etc.

Cancel
Connect

**Direct Connection**

In case the device is not showing up in device list page after router configuration is done, you may enter the IP address( to be found on your router for this device) manually and continue for weather service setup , view live data etc.

192.168.50.222

Cancel
Connect

Once done, it will enter the Live Data page.

If not, please find the test mode option under the Menu - press the button and let it run for one minute, then send us the screenshot of the log to support@ecowitt.com:

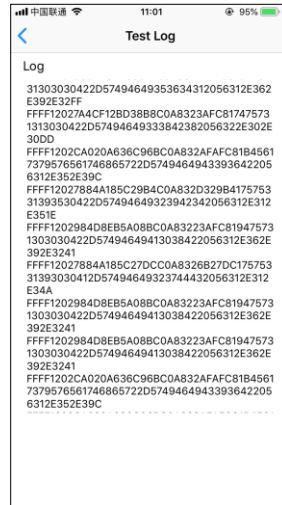
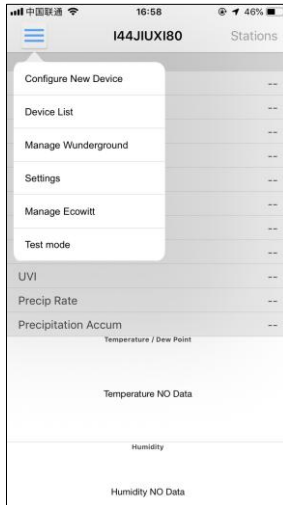

## 10.6 Calibration

When on the “Live Data” screen, you can press the “More” button (upper right) to enter the calibration screen.

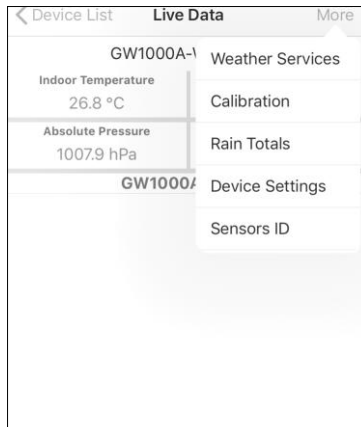

## 10.7 Editing Rain totals

When on the “Live Data” screen, you can press the “More” button (upper right) to edit the rain totals if needed.



## 10.8 Device Settings

On the Live Data page, press “More” on the top-right, and select “Device Settings” to set the following:

- Select sensor type.
- Set time zone.
- Reboot Device.
- Reset to Factory Settings.
- Firmware upgrade (only display when new firmware is available)

## 10.9 Sensor ID

On Live Data page, press More and select “Sensors ID” to set the following:

- View sensor ID, signal strength and battery power condition. 1-4 bars means 1-4 successful successive signal receptions without missed ones.
- Register the sensor when offline.
- Enable or disable the sensor.
- Input the Sensor ID when offline.

## 11 Maintenance

The following steps should be taken for proper maintenance of your station

1. Clean the rain gauge once every 3 months. Rotate the funnel counter-clockwise and lift to expose the rain gauge mechanism, and clean with a damp cloth. Remove any dirt, debris and insects. If bug infestation is an issue, spray the array lightly with insecticide.



**Figure: Rain gauge installation and maintenance**

3. Clean the solar radiation sensor and solar panel every 3 months with a non-abrasive slightly damp cloth.
4. Replace batteries every 1-2 years. If left in too long, the batteries may leak due to environmental challenges. In harsh environments, inspect the batteries every 3 months (while cleaning the solar panel).
5. When replacing the batteries, apply a corrosion preventing compound on the battery terminals, available at Amazon and most hardware stores.
6. In snowy environments, spray the top of the weather station with anti-icing silicon spray to prevent snow build up.

## 12. Troubleshooting Guide

Problem	Solution
<p>Outdoor sensor array does not communicate to the display console.</p>	<p>The sensor array may have initiated properly and the data is registered by the console as invalid, and the console must be reset. Press the reset button as described in Section 5.2.</p> <p>With an open ended paperclip, press the reset button for 3 seconds to re-sync the console with the sensor array about 10 feet away.</p> <p>The LED next to the battery compartment will flash every 16 seconds. If the LED is not flashing every 16 seconds...</p> <p>Replace the batteries in the outside sensor array.</p> <p>If the batteries were recently replaced, check the polarity. If the sensor is flashing every 16 seconds, proceed to the next step.</p> <p>There may be a temporary loss of communication due to reception loss related to interference or other location factors, or the batteries may have been changed in the sensor array and the console has not been reset. The solution may be as simple as powering down and up the console (remove AC power and batteries, wait 10 seconds, and reinsert AC power and batteries).</p>
<p>Temperature sensor reads too high in the day time.</p>	<p>Make certain that the sensor array is not too close to heat generating sources or structures, such as buildings, pavement, walls or air conditioning units.</p> <p>Use the calibration feature to offset installation issues related to radiant heat sources. Reference Section 10.6.</p>
<p>Relative pressure does not agree with official reporting station</p>	<p>You may be viewing the absolute pressure, not the relative pressure.</p> <p>Select the relative pressure. Make sure you properly</p>

Problem	Solution
	calibrate the sensor to an official local weather station. Reference Section 6.4.3 for details.
Rain gauge reports rain when it is not raining	An unstable mounting solution (sway in the mounting pole) may result in the tipping bucket incorrectly incrementing rainfall. Make sure you have a stable, level mounting solution.
Data not reporting to Wunderground.com	<ol style="list-style-type: none"> <li data-bbox="430 341 1034 581">1. Confirm your password or key is correct. It is the password you registered on Wunderground.com. Your Wunderground.com password cannot begin with a non-alphanumeric character (a limitation of Wunderground.com, not the station). Example, \$oewkrf is not a valid password, but oewkrf\$ is valid.</li> <li data-bbox="430 636 1009 769">2. Confirm your station ID is correct. The station ID is all caps, and the most common issue is substituting an O for a 0 (or visa versa). Example, KAZPHOEN11, not KAZPH0EN11</li> <li data-bbox="430 824 1009 921">3. Make sure the date and time is correct on the console. If incorrect, you may be reporting old data, not real time data.</li> <li data-bbox="430 976 1034 1074">4. Make sure your time zone is set properly. If incorrect, you may be reporting old data, not real time data.</li> <li data-bbox="430 1097 1028 1161">5. Check your router firewall settings. The console sends data via Port 80.</li> </ol>
No Wi-Fi connection	<ol style="list-style-type: none"> <li data-bbox="430 1193 1009 1318">1. Check for Wi-Fi symbol on the display. If wireless connectivity is successful the Wi-Fi icon  will be displayed in the time field.</li> <li data-bbox="430 1373 956 1437">2. Make sure your modem Wi-Fi settings are correct (network name, and password).</li> </ol>

Problem	Solution
	<ol style="list-style-type: none"><li data-bbox="430 166 1034 299">3. The console only supports and connects to 2.4 GHz routers. If you own a 5 GHz router, and it is a dual band router, you will need to disable the 5 GHz band, and enable the 2.4 GHz band.</li><li data-bbox="430 354 994 382">4. The console does not support guest networks.</li></ol>