

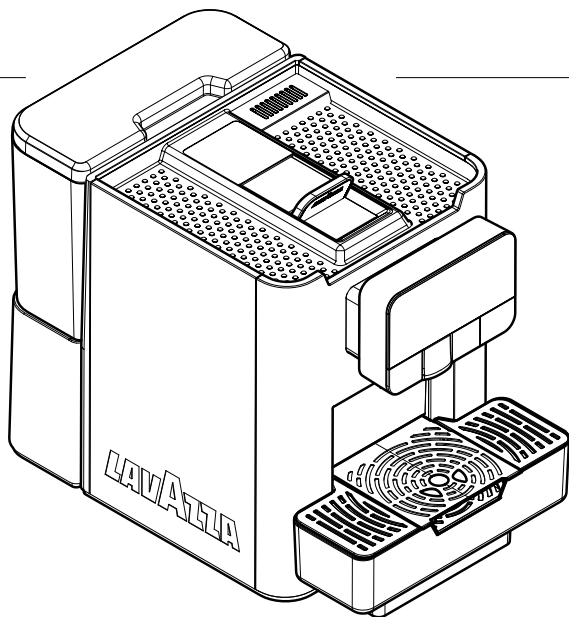

LAVAZZA
blue

Automatic machine for espresso coffee and hot beverages

OMNIA 120V



Type: SUP048RF



WARNING: Read these instructions carefully before using the machine.

OPERATION AND MAINTENANCE

US



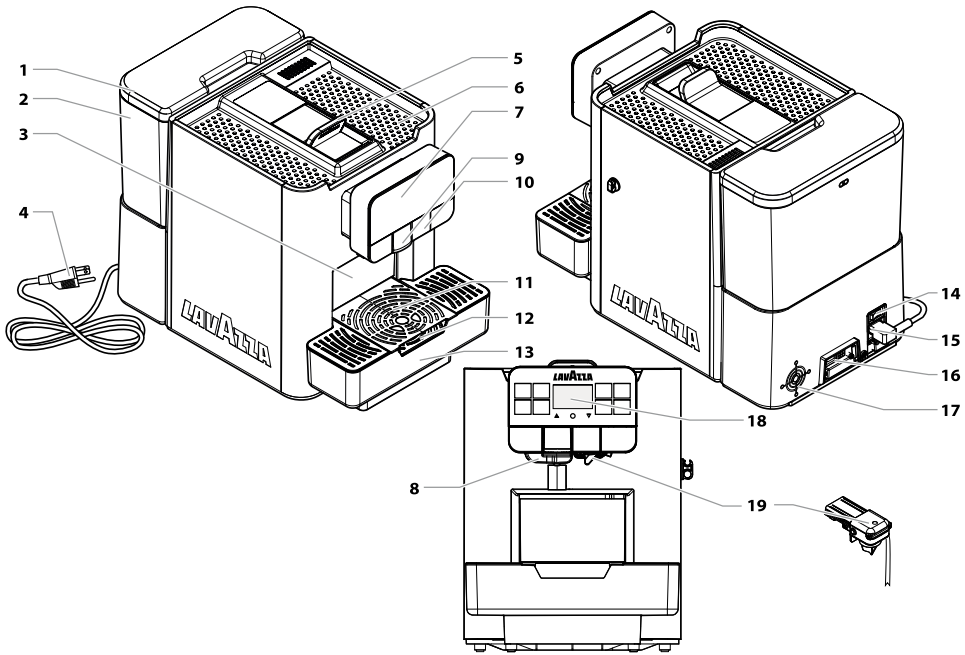



MAIN PARTS



1	Water tank lid
2	Water tank
3	Used capsule drawer
4	Power cord
5	Capsule loading tray
6	Cup holder surface
7	Touch control panel
8	Hot water disp. spout
9	Moving coffee spout
10	Cappuccinatore cover

11	Cup holder (small cups)
12	Cup holder (mugs)
13	Drip tray
14	Power button
15	Chassis plug
16	USB port
17	Ventilation fan
18	Display
19	Cappuccinatore

SAFETY INSTRUCTIONS

-  **Never allow water to come into contact with any of the electrical parts of the machine: danger of short circuit! Hot water and steam may cause scalding!**
-  The machine may be used by children older than 8 or by persons with reduced physical, mental or sensory abilities or lacking sufficient experience and/or skills, provided that they are supervised or instructed on how to use the appliance correctly and understand the hazards involved.
-  **Intended Use**
-  The machine is intended to be used in small offices/organisations only.
-  Do not make any technical changes or use the machine for unauthorized purposes as this would create serious hazards!
-  Children must never play with the appliance.
-  Children must not carry out cleaning and maintenance without supervision.

Power Supply

 The machine must be connected to the power supply by the service provider, in accordance with its specifications.

Power cord

 Never use power defective cords.

 Report any defects in the cord and/or plug to the service provider immediately.

 Do not pass the power cord around corners, over sharp edges or over hot objects and keep it away from oil.

 If the power cord is damaged, it must be replaced by the manufacturer, its service centre or by adequately qualified personnel in order to avoid any risks.

 Do not use the power cord to carry or pull the machine. Do not pull out the plug by the power cord or touch it with wet hands or feet. Do not let the power cord hang freely from tables or shelves.

Safety of Persons

 Ensure that children cannot play with the machine and/or the packaging materials.

Danger of Burning

 Do not touch the hot water dispensing spout or the coffee/beverage spout.

Fire Safety Precautions

 In case of fire, use carbon dioxide (CO₂) extinguishers. Do not use water or dry powder extinguishers.

Suitable Location for Operation and Maintenance

 The machine should be installed by the service provider in accordance with the safety regulations in force at the time of installation.

 The machine may only be moved by the service provider.

 Do not use the machine outdoors.

 Do not install the machine in a location where water jets may be used.

 Do not use open flames and/or incandescent objects near the machine so as not to damage or melt the machine housing.

 Do not use in environments in which the temperature could reach values equal to and/or less than 2°C / 35.6°F or higher than 32°C / 89.6°F. If the machine has been exposed to such conditions, alert the service provider, who will carry out a safety check.

 The appliance must be installed on a horizontal surface.

 The machine must only be installed in places where it can be checked by qualified staff.

Cleaning the machine

 Before cleaning the machine, switch OFF (0) the power button and the remove the plug from the power socket. Wait for the machine to cool down.

 Never immerse the machine in water!

 It is strictly forbidden to tamper with the internal parts of the machine.

 Do not clean the machine using jets of water.

 The appliance and its components must be cleaned and washed after a period of inactivity.

Using Milk

 Milk must be used and stored in accordance with the instructions given on the manufacturer's original packaging.

 We accept no liability for use of milk unsuitable for human consumption.

 Milk, due to its nature, must be kept cold at a temperature not exceeding 4°C / 39.2°F. High temperatures can turn it sour. For this reason, the Cappuccinatore must be cleaned after each use, as described in the manual.

 Clean the Cappuccinatore following the instructions described in this manual.





Milk dosage

-  The machine has a default dose set-up for all milk beverages. However, the dose of beverage in the cup may vary according to the type of milk used. Therefore, it is recommended to check the doses - using the milk type normally used - and, if necessary, to set them again according to the user needs.

Storing the Machine

-  When the machine will not be used for a long period of time, turn it off and unplug it from the outlet. Store the machine in a dry place, out of the reach of children. Keep it protected from dust and dirt.

Servicing Maintenance /

-  In case of failures, defects or suspected faults resulting from a fall, immediately unplug the machine from power socket and alert the service provider or specialised technician.
-  Never attempt to operate the machine if it is faulty.
-  Only the service provider and/or technician may service or repair the machine.
-  Only skilled and experienced people - with particular reference to safety and hygiene - are allowed to access the service area.

CONTENTS

MAIN PARTS	2		
1 INTRODUCTION TO THE MANUAL	9		
1.1 PREAMBLE	9		
1.2 ICONS USED	10		
2 INFORMATION ABOUT THE APPLIANCE	11		
2.1 INFORMATION FOR THE MAINTENANCE TECHNICIAN	11		
2.2 DESCRIPTION AND INTENDED USE	11		
2.3 APPLIANCE IDENTIFICATION	12		
2.4 TECHNICAL SERVICE LAVAZZA	12		
2.5 TECHNICAL SPECIFICATIONS	13		
3 SAFETY	14		
3.1 PREAMBLE	14		
3.2 GENERAL SAFETY INSTRUCTIONS	14		
3.3 OPERATOR REQUIREMENTS	15		
4 HANDLING AND STORAGE	16		
4.1 UNLOADING AND HANDLING	16		
4.2 STORAGE	16		
5 INSTALLATION	17		
5.1 CAUTIONS	17		
5.2 UNPACKING AND POSITIONING	18		
5.3 CONNECTION TO THE ELECTRIC NETWORK	20		
6 DESCRIPTION OF CONTROLS	21		
6.1 POWER BUTTON	21		
6.2 DISPLAY	21		
6.3 KEYPAD	21		
6.4 BUTTON DESCRIPTION DURING NORMAL OPERATION	21		
7 SUPPLY AND START UP	23		
7.1 FILLING THE WATER TANK	23		
7.2 MEASURING AND ADJUSTING WATER HARDNESS	24		
7.3 WATER FILTER	24		
7.4 ADJUSTING THE COFFEE DISPENSING SPOUT	30		
7.5 TURNING ON/OFF THE MACHINE	31		
7.6 FIRST USE - USE AFTER A LONG PERIOD OF INACTIVITY	31		
7.7 WASHING THE PARTS COMING INTO CONTACT WITH FOOD	32		
7.8 USING THE APPLIANCE	32		
8 PROGRAMMING MENU	33		
8.1 BUTTON DESCRIPTION IN PROGRAMMING MODE	33		
8.2 USER PROGRAMMING	33		
8.3 MAINTENANCE PROGRAMMING	36		
8.4 TECHNICAL PROGRAMMING	42		
9 OPERATION AND USE	52		
9.1 WARM-UP AND RINSING	52		
9.2 RINSE AND SELF-CLEANING	52		
9.3 LOADING CAPSULES	53		
9.4 USING THE SUCTION TUBE	54		
9.5 BREWING A SINGLE COFFEE / PRODUCT	55		
9.6 DISPENSING HOT WATER	60		
9.7 BREWING "DOUBLE SHOT" PRODUCTS	61		
9.8 EMPTYING THE CAPSULE DRAWER AND DRIP TRAY	62		
10 CLEANING AND MAINTENANCE	64		
10.1 GENERAL NOTES FOR CORRECT OPERATION	64		
		10.2 CLEANING AND SCHEDULED MAINTENANCE	65
		11 TROUBLESHOOTING	80
		11.1 WARNING SIGNALS	80
		11.2 PROBLEMS - CAUSES - SOLUTIONS	83
		12 STORAGE - DISPOSAL	84
		12.1 LOCATION CHANGE	84
		12.2 INACTIVITY AND STORAGE	84
		13 INSTRUCTIONS FOR END OF OPERATIONAL LIFE DISPOSAL	85

I INTRODUCTION TO THE MANUAL

I.1 Preamble

 This publication is an integral part of the machine and has to be read carefully to ensure its correct use in accordance with the essential health and safety requirements.

 This manual contains the technical information necessary to properly perform the operating, installation, cleaning and maintenance procedures.

 Always refer to this manual before carrying out any operation.

This product has been manufactured by SaGa Coffee S.p.A. and sold under its own responsibility. SaGa Coffee S.p.A. is the guarantor of the product. Saeco is a registered trademark of Koninklijke Philips N.V. and its use is licensed by Koninklijke Philips N.V.

 This publication should be carefully kept with the machine throughout its service life, including transfers of ownership.

 If this manual is damaged or lost, a copy may be requested from the manufacturer or the technical service by indicating the data contained on the data plate on the rear side of the machine.

 The manufacturer reserves the right to make changes without prior notice.

Manufacturer: SaGa Coffee S.p.A.
Località Casona, 1066 - 40041 Gaggio Montano
Bologna, Italy
www.saecoprofessional.com

1.2 Icons Used

Various kinds of warnings are contained in this manual to highlight the different hazard or competence levels.

Each icon is followed by a message suggesting operating and behaviour procedures and providing useful information for the correct operation of the machine.

Warning

It is used to highlight danger situations for the persons in charge of using, refilling and servicing the machine.

Prohibition

It is used to highlight actions/operations not to be performed.

Important

It is used to indicate operations that, if correctly performed, preserve machine performance.

Suggested solutions

It is used to indicate alternative procedures which make programming and/or maintenance operations quicker.

User

It is used to indicate the user of the machine. Users are not allowed to perform any cleaning or maintenance operations.

Supply operator

It is used to indicate those operations that must be performed only by the person in charge of refilling and cleaning the machine.

Supply operators can not perform any operations requiring a Maintenance Technician.

Maintenance technician

It is used to signal those operations that must be performed only by the specialised maintenance technicians.

2 INFORMATION ABOUT THE APPLIANCE

2.1 Information for the Maintenance Technician

 The appliance must be installed in a well-lit, sheltered and dry place and on a table suitable to bear its weight.

To ensure its correct operation and reliability over time, comply with the following recommendations:

- Room temperature: from +2°C / 35,6°F to +32°C / 89,6°F
- maximum humidity allowed: 80% (non-condensed).

For special installations, not covered by this manual, please contact the dealer or the local importer. If this is not possible, please contact the Manufacturer.

The technical service is available for any explanation or information regarding the correct operation of the machine and to satisfy any request for spare parts supply or technical assistance.

The Maintenance Technician must carefully read and observe the safety warnings contained in this manual to ensure that installation, start-up, use and maintenance operations are performed in complete safety.

This manual is an essential part supplied with the machine and should always be available for reference before any operation on the machine.

2.2 Description and Intended Use

This machine is automatically used to brew:

- Coffee and espresso coffee brewed exclusively from LAVAZZA BLUE or LAVAZZA EXPERT compatible capsules.
- hot water to prepare beverages;
- milk-based beverages using the Cappuccinatore supplied.

The elegant machine housing has been designed for use in small offices, businesses and institutions.

Using the machine for any other purpose is considered dangerous and as a misuse.

 Misuse voids all forms of warranty, releasing the Manufacturer from any responsibility for damage to property and/or personal injury.

 The following are also considered misuse:

- any use other than the intended use and/or employing methods other than those described in this manual;
- any operation on the machine in breach of the instructions provided in this manual;
- any tampering with parts and/or safety devices not previously authorised by the Manufacturer and performed by unauthorised personnel;
- Use of LAVAZZA BLUE or LAVAZZA EXPERT not compatible capsules.
- machine installation in an outdoor environment.

In such cases the customer will be charged with the machine repair cost.

2.3 Appliance Identification

The appliance is identified by the model name and serial number shown on the special plate.

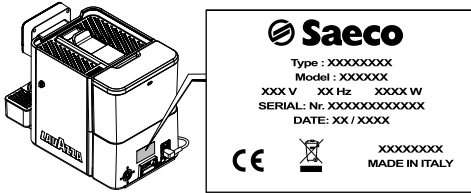

The plate contains the following data:

- name of the Manufacturer;
- marks of conformity;
- model;
- serial number;
- year and month of manufacture;
- supply voltage (V);
- supply frequency (Hz);
- electrical power consumption (W);
- appliance code.

 It is strictly forbidden to tamper with or modify the data plate.

 When contacting the technical service, always refer to this plate by indicating the technical data shown on it.

2.4 Technical Service Lavazza

In the event of a failure or malfunction that can not be solved, please contact:

Technical Service Lavazza
 Strada di Settimo 410
 10156 Torino - Italy -
 Tel. +39 0112398429
 Fax. +39 01123980466
 technicalservice@lavazza.it

2.5 Technical Specifications

Size (w x h x d)	280 x 380 x 480 mm / 11 x 15 x 18.9 inches
25 capsules	approx. 9 kg / 19.8 lbs.
Machine housing material	Thermoplastic material
Power Rating	See the data plate
Supply Voltage	See the data plate
Power cord length	approx. 1200 mm / 47 inches
Capacity	Water tank 4 liters / 135 oz Used capsule drawer 25 capsules
Capsule type	LAVAZZA BLUE - LAVAZZA EXPERT
Control panel	Front panel
A-weighted sound pressure level	less than 70 dB
Pump pressure	Max 1.9MPa (19 bar)
Operating conditions	Minimum temperature: higher than 2°C / 35.6°F Maximum temperature: less than 32°C / 89.6°F Maximum humidity: less than 80%
Safety devices	Boiler pressure safety valve Safety thermostat

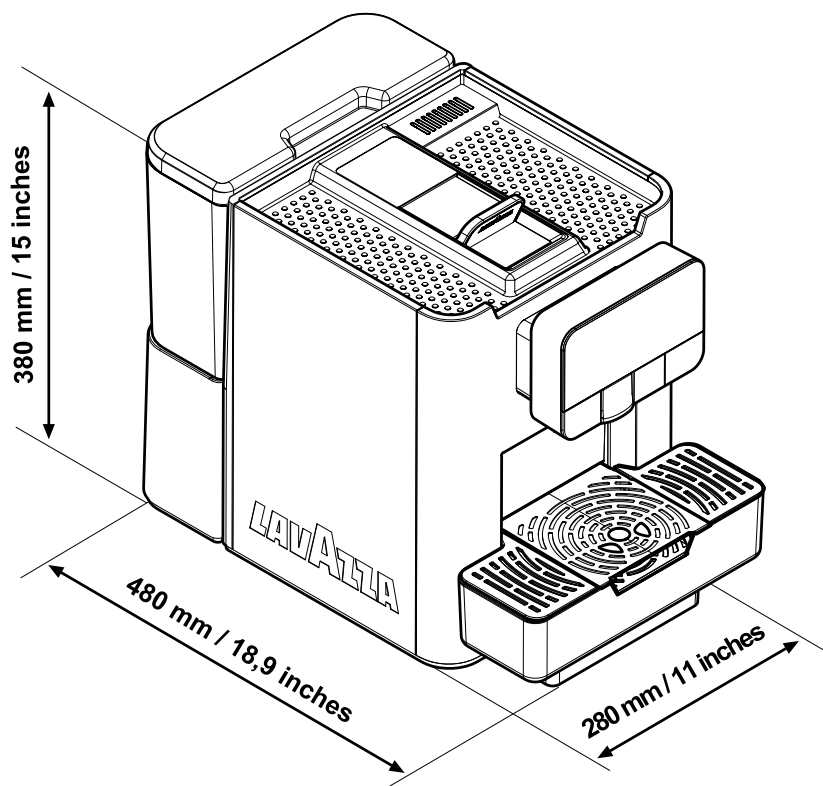

3 SAFETY

3.1 Preamble

The manufacturer acknowledged the following standards in the design and certification stages:

- CAN/CSA-C22.2 No. 109-17 - Commercial Cooking Appliances
- UL 197 - Commercial Electric Cooking Appliances

3.2 General Safety Instructions

It is forbidden to:

- tamper with or disable the safety systems installed on the machine;
- service the machine prior to unplugging the power cord;
- install the appliance outdoors. It is necessary to place it in dry areas where the temperature can never drop below 2°C / 35.6°F to prevent it from freezing
- use the appliance for purposes other than those indicated in the sale contract and in this manual;
- electrically connect the appliance using multi-sockets or adapters;
- use jets of water for cleaning operations.

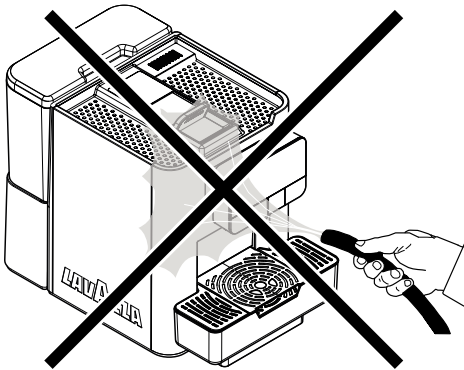





It is mandatory to:

- check conformity of the power supply;
- use original spare parts;
- carefully read the instructions contained in this manual and in the attached documents;
- use personal protective equipment when performing installation, testing and maintenance operations.

Precautionary measures to prevent human errors:

- make the operator aware of safety issues;
- handle the appliance, either packaged or unpackaged, in complete safety;
- Get to know its installation procedures, correct operation and limits thoroughly
- dismantle the appliance in complete safety, in accordance with the workers' health and environmental protection regulations in force.

 To avoid mechanical manufacturing residues from coming into contact with beverages, dispense approximately 0.5 l / 17oz water for each brewing or dispensing setting before putting it into operation. The dispensed beverages can be drunk only after performing this operation.

-  In case of failure or malfunctioning, please refer only to the qualified personnel of the technical service.
-  The Supply operator is not allowed to carry out operations indicated in this manual as competence of the Maintenance Technician.
-  The manufacturer is not liable for damage to persons or property resulting from failure to follow the safety instructions provided in this section.

Maintenance technician

The maintenance technician is the only person authorised to service the machine, start the programming procedures and perform the adjustment, set up and maintenance operations.

-  Access to the internal area is restricted to persons having knowledge and practical experience of the appliance, in particular as far as safety and hygiene are concerned.

3.3 Operator Requirements

Three operators with different skills are required in order to guarantee the appliance's safety:

User

The user is not allowed to access the internal parts of the machine.

Supply operator

Only the Maintenance Technician is in charge of refilling the machine with products, cleaning the outside of the appliance, turning it on and off.

4 HANDLING AND STORAGE

 All the operations described in this chapter must be performed exclusively by the service provider or a specialised technician, who shall organise all the operating steps and use only suitable means to ensure strict compliance with the safety regulations in force.

4.1 Unloading and Handling

Unloading from the transport vehicle and handling operations of the appliance must be carried out by qualified personnel only and using suitable equipment.

 The appliance must always be kept in upright position.

 Do not:

- drag the appliance;
- overturn or lay down the appliance during transport and handling;
- shake the appliance;
- lift the appliance by using ropes or cranes;
- leave the appliance exposed to bad weather, in humid areas or close to heat sources.

4.2 Storage

The machine is packed in cardboard and expanded polystyrene packaging.

If the appliance is not immediately installed, it shall be kept in a sheltered place according to the following instructions:

- The packaged appliance must be stored in a closed and dry area, at a temperature ranging between 1°C and 40°C / 33.8°F and 104°F
- maximum humidity below 90% (non-condensed);
- do not put other appliances or boxes on the appliance;
- in any case, it is good practice to protect the appliance from possible deposits of dust or other substances.

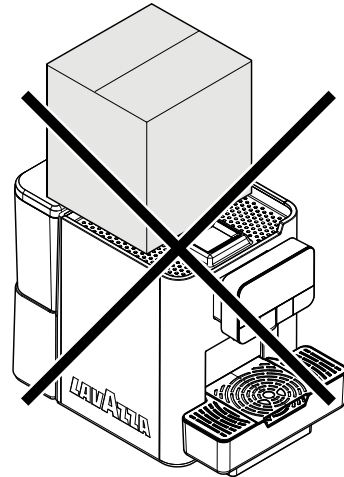

 Due to the total weight, do not stack more than three machines on top of each other. The machine should be stored in its original packaging, in a dry and/or dust-FREE place.

5 INSTALLATION

 All the operations described in this chapter must be performed exclusively by the service provider or a specialised technician, who shall organise all the operating steps and use only suitable means to ensure strict compliance with the safety regulations in force.

5.1 Cautions

 The appliance cannot be installed outdoors. Avoid placing it in areas where the temperature is less than 2°C / 35.6°F or higher than 32°C / 89.6°F. Do not place it in particularly humid or dusty areas. It should neither be installed in places where water jets are used for cleaning operations nor where there is a risk of fire or explosion.

Make sure that the installation place is compatible with the following specifications, before unpacking the appliance:

- The power supply (outlet) connection point must be positioned in an easily accessible place and at a distance not exceeding 1.2 meters / 47 inches
- The supporting surface must NOT have a slope of more than 2° / 35.6°F
- the socket voltage must correspond to that indicated on the appliance data plate.

 The appliance must be installed on a horizontal surface.

 The supporting surface must be adequate to bear the machine weight and clean.

 Access to the machine and the plug should be kept clear at all times in order to allow users to easily reach them and to leave the area immediately if required.

 The presence of magnetic fields or proximity to electrical machines which generate interference could cause the electronic controls of the machine to malfunction. At temperatures of 0°C / 32°F the internal parts that contain water might freeze. Do not use the machine under these conditions.

The following illustration shows the required access distances:

- to the keypad on the front of the appliance;
- to the service units in the event of failure.

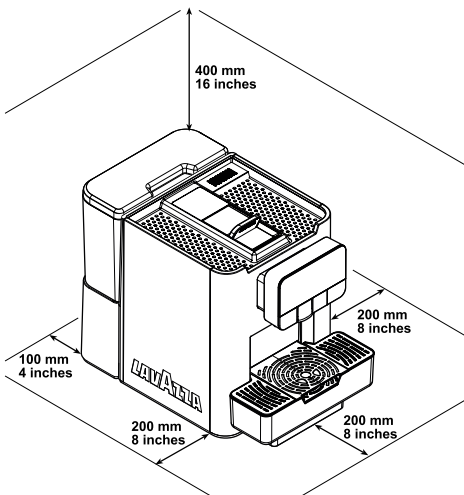

 The machine can be combined with a fridge.

5.2 Unpacking and Positioning

On receipt of the appliance, make sure that it has not suffered any damage during transport or that the packaging has not been unduly opened with consequent stealing of the components contained in it. If damage of any kind is found, the courier must be informed and notice must be immediately given to the importer or to the seller. If these are not in the purchaser's country, please contact the manufacturing company directly.

List of Standard Accessories

Manual: instructions on how to use the machine.

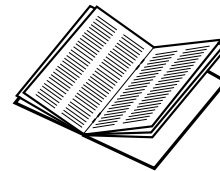

Power cord: to connect the machine to the mains.



Silicone hose: Once connected to the Cappuccinatore it allows the milk to be sucked from its container.

Hose length 46 cm / 18 inches for standard use



Brush diameter 6 mm / 0.24 inches.



Brush diameter 4 mm / 0.16 inches.

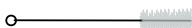

Cappuccinatore silicone hose scraper.

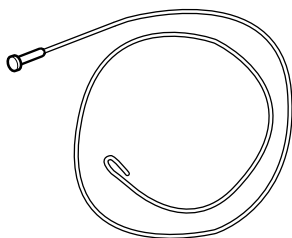

List of Opt. Accessories (not included)

Water hardness test: quick test to determine the actual hardness of the water used to prepare beverages; this test is of fundamental importance to set the water hardness in the machine.

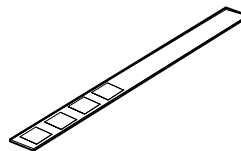

Descaling solution: to remove limescale build-up in the water circuit caused by normal use.



Water filter: to remove any unpleasant flavours in the water and reduce water hardness. This will improve machine use.



Water net tank kit (code 18400053): It allows you to connect the machine to the water network by replacing the independent water tank, supplied with the machine, with this water net tank kit. Follow all the instructions provided with the kit for a correct assembly and use.

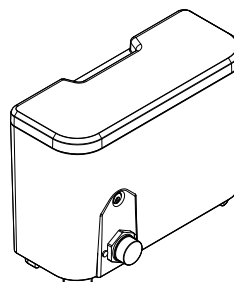



5.3 Connection to the Electric Network

 This operation must only be performed by specialised technical personnel or by the service provider.

 The Maintenance Technician, who is in charge of the appliance's installation, shall make sure that:

- the power supply system complies with the safety instructions in force;
- the voltage corresponds to that indicated on the appliance data plate.

 In case of doubt, do not proceed with the installation and ask qualified and authorised personnel to accurately check the system.

 Do not use adapters or multi-sockets.

 Make sure that the power cord plug is easily reachable after installation.

6 DESCRIPTION OF CONTROLS

6.1 Power button

It is located in the lower left part on the rear of the machine.

If set to the "I" position the machine turns on (electrical functions enabled).

If set to the "O" position the machine turns off (electrical functions disabled).

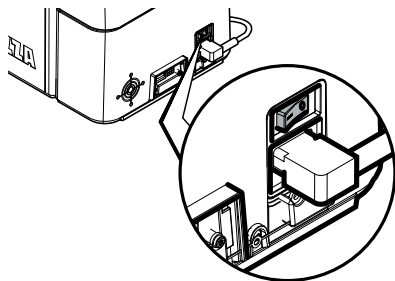

6.2 Display

The display shows the messages during normal operation and during the programming and maintenance phase.

6.3 Keypad

 The function of each button changes according to the change of the appliance phase (ordinary dispensing or programming phase).

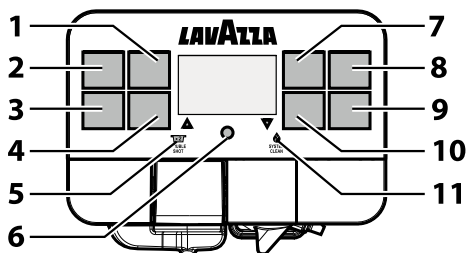

1	"Long" button
2	"Espresso" button
3	"Coffee 8 Oz." btn
4	"Hot Water" button
5	"Up/Double Shot" button
6	"MENU/OK" button
7	"Coffee with a dash of milk" button
8	"Cappuccino" button
9	"Milk" button
10	"Hot Beverage" btn
11	"Down/System Clean" button

6.4 Button Description during Normal Operation

"Long" button

Press this button to brew a long coffee.

"Espresso" button

When this button is pressed, an espresso coffee is brewed.

"Coffee 8 Oz." btn

Press this button to brew a 8 oz. coffee.

"Hot Water" button

Press this button to dispense hot water.

"Up/Double Shot" button

Press this button to enable the available "Double shot" beverages. The "Double shot" is available for espresso x2, coffee with a dash of milk x2, cappuccino x2 and milk x2. If inside a menu, press this button to scroll up the menu options.

"MENU/OK" button

Press this button to access the user menu, which allows you to perform a few machine cleaning cycles (Cappuccinatore and brew unit) and to access the maintenance menu. Once you have entered the menu, this button allows you to confirm the selected menu option.

"Coffee with a dash of milk" button

Press this button to brew a coffee with a dash of milk.

"Cappuccino" button

When this button is pressed, a cappuccino is brewed.

"Milk" button

When this button is pressed, a Latte Macchiato is brewed.

"Hot Beverage" btn

Press this button to brew an instant product.

"Down/System Clean" button

Press this button to access the "Clean Cappuccinatore" menu directly.

If inside a menu, press this button to scroll down the menu options.

7 SUPPLY AND START UP

7.1 Filling the Water Tank

 Before using the machine for the first time, wash the water tank carefully. Fill the water tank with fresh drinking water only. Hot or carbonated water, as well as other liquids, will damage the machine.

Remove the lid from the water tank.

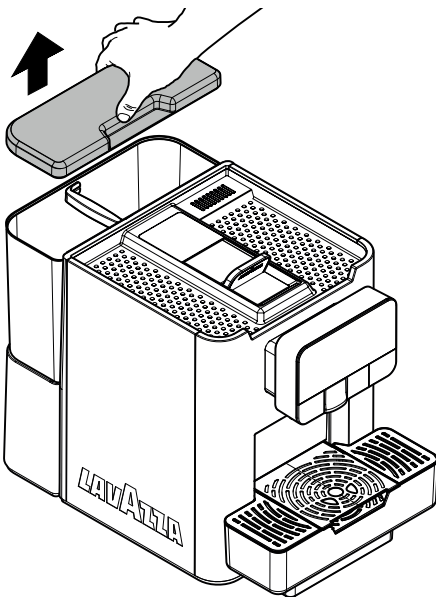

Remove the tank; lift it using the inside handle.

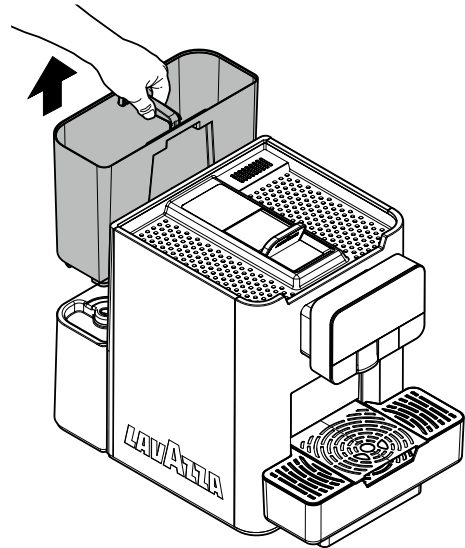

Rinse and fill it with fresh water; do not exceed the level (MAX) indicated on the tank.

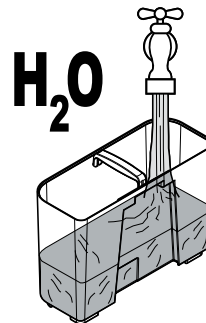



 When filling the water tank, use sterile disposable gloves to prevent bacteriological contamination.

Insert the water tank back into its seat and refit the lid.

7.2 Measuring and Adjusting Water Hardness

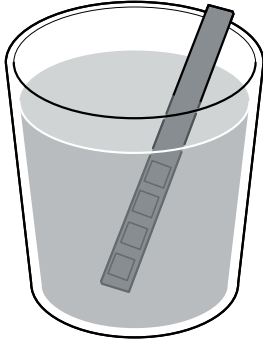
Measuring water hardness is very important in order to correctly manage the anti-scale filter and the frequency with which the machine must be descaled. Immerse the water hardness test strip (not included) in water for 1 second.



 the test strip is only valid for one measurement.

Check how many squares change colour and then consult the table.

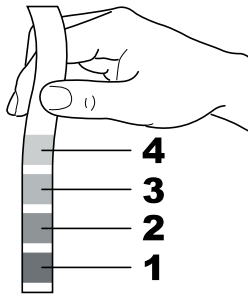

The numbers correspond to the settings indicated in the following machine adjustments.

1	HARDNESS 1 (very soft)
2	HARDNESS 2 (soft)
3	HARDNESS 3 (medium)
4	HARDNESS 4 (hard)

Switch to machine programming mode as described in section "Access to the Technical Menu".

Scroll the menu until the "Settings" option.



Press the "OK" button to confirm.
Scroll the menu until the "Water hardness" opt.









Press the "OK" button to confirm.

 The machine is supplied with standard adjustments, suitable for most uses.

Press the "Up" button to increase the value or the "Down" button to decrease the value. Press the "OK" button to confirm the selected change.
After adjusting the water hardness, install the anti-scale filter as described in the following section.

7.3 Water filter

Water is a key element for a good espresso coffee. Therefore, it should always be filtered in a professional manner. The water filter is designed to reduce limescale deposits inside the coffee machine and supply filtered water to preserve the aroma and taste of each cup of coffee. If the 8 water filter kit is used as indicated in this user manual, it will not be necessary to perform machine descaling for 5000 cups (with a 100 ml / 3.4 oz capacity). This filter is easy to use and its sophisticated technology is effective in preventing limescale build-up. This way, water will always be perfect and will give a much more intense aroma to your espresso coffee.

-  Measuring water hardness is very important in order to correctly manage the anti-scale filter and the frequency with which the machine must be descaled.
-  The machine must be fully free of limescale before starting to use the water filter.
-  If the filter was not activated on the first use and more than 50 cups were brewed (with a 100 ml / 3.4 oz capacity), the machine must be descaled before activating the filter.
-  Replace the water filter as soon as the capacity drops to 0% and the filter icon starts blinking quickly. Replace the water filter at least every 3 months, even if the machine has not indicated its need for replacement.
-  We recommend buying a new filter when its capacity drops to 10% and the filter icon starts blinking slowly. In this way you can replace the filter when its capacity drops to 0%.
-  The anti-scale filter should be replaced whenever indicated by the machine. Before descaling, remove the anti-scale filter from the water tank.

7.3.1 Preparing and installing the water filter

The water filter can be fitted on first installation as part of the installation procedure. If you failed to fit the water filter on first use, you can install it at a later stage by accessing the menu as described below. Remove the water filter from the package. The filter should be set according to the measurements performed to set water hardness. Use the water hardness test strip (not provided).

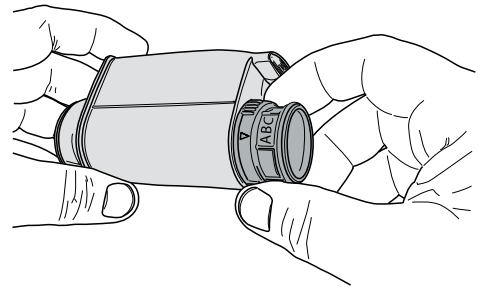

A	Soft water
B	Hard water (standard)
C	Very hard water

Immerse the water filter vertically (opening facing up) in cold water and softly press its sides to make the air bubbles get out.

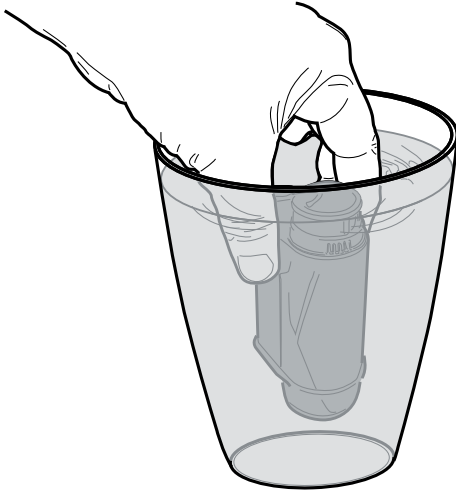

Switch to machine programming mode as described in the "Access to the Maintenance Menu" section. Scroll the menu until the "Water filters management" opt.



Press the "Ok" button. The display shows the number of water filters that have been installed previously, from 0 to 8 filters.

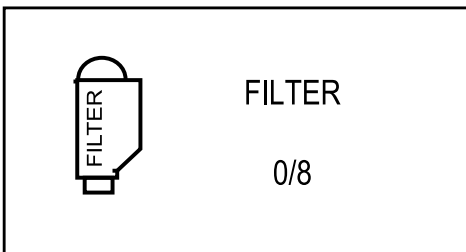

Press the "OK" button to confirm. The machine requires descaling and the following screen appears when: 5 liters of water have been dispensed without filters fitted or the water filter is completely exhausted or it is the eighth water filter. Otherwise activate the filter as described below, skipping the descaling operations.

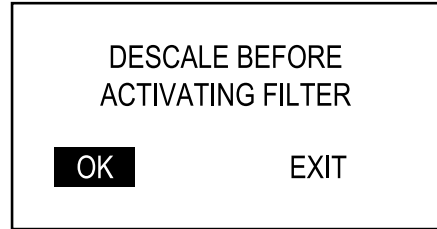

Select "OK" and press the "OK" button. The following screen is displaying:

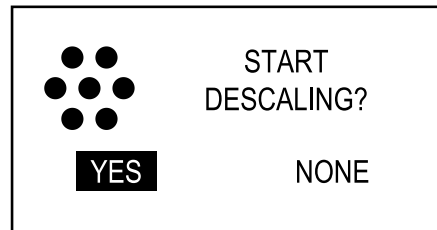

Select "YES" and press the "OK" button. The following screen is displayed:

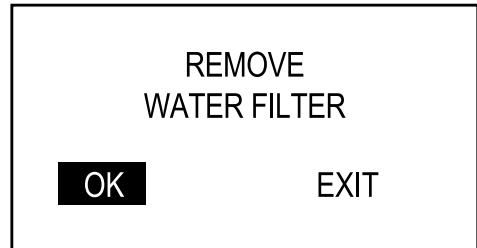

Remove the tank from the machine and empty it. Remove the small white filter from the tank and store it in a dry place sheltered from dust.

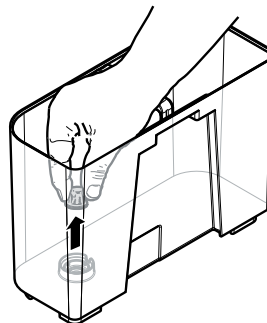

Select "OK" and press the "OK" button. The following screen is displayed:

EMPTY DRIP TRAY

OK

EXIT

Remove and empty the drip tray.

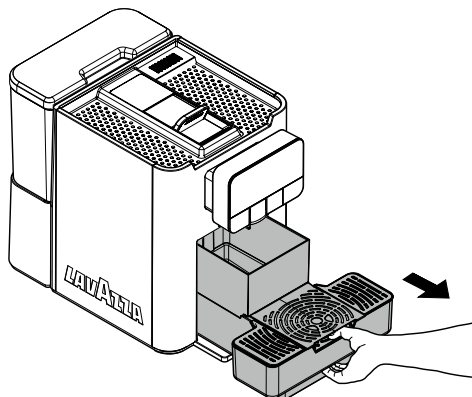

After emptying it, put the drip tray back into place. Select "OK" and press the "OK" button. The following screen is displayed:

INSERT
CAPPUCCINATORE

OK

EXIT

Check that the Cappuccinatore is correctly positioned. Press the "OK" button. The following screen is displayed:

PLACE A CONTAINER
UNDER THE SPOUTS

OK

EXIT

Place a large container under the dispensing spouts (hot water and coffee).

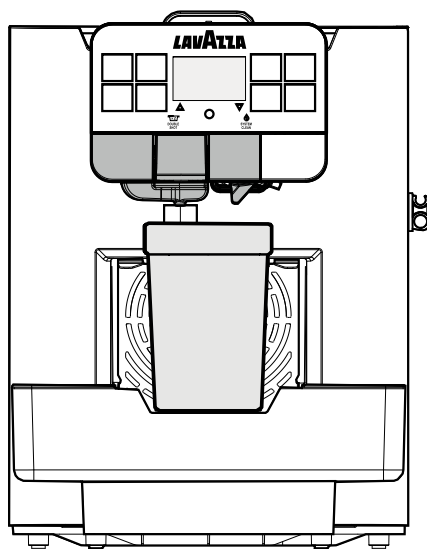

Select "OK" and press the "OK" button. The following screen is displayed:

POUR DESCALER
AND WATER INTO
WATER TANK

OK

EXIT

Pour 250 ml / 8 oz descaler and 750 ml / 25 oz water into the water tank. Select "OK" and press the "OK" button. The following screen is displayed:

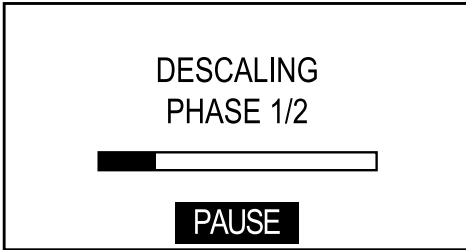

The first descaling phase starts. Press the "OK" button to pause the cycle. Press the "OK" button again to resume the cycle. When the solution in the tank is finished, the machine requests to empty and rinse the tank with fresh drinking water.



Rinse the water tank thoroughly and fill it with fresh drinking water up to the MAX level. Press the "OK" button. The following screen is displayed:

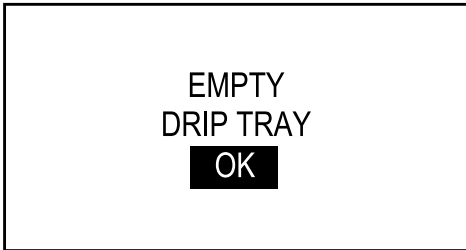

Remove the drip tray. After emptying it, put the drip tray back into place. Press the "OK" button. The following screen is displayed:

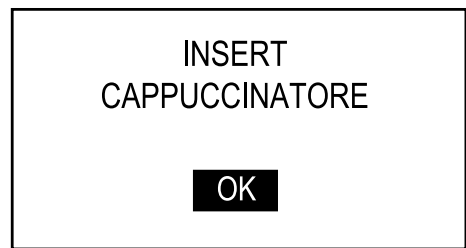

Check that the Cappuccinatore is correctly positioned. Press the "OK" button. The following screen is displayed:

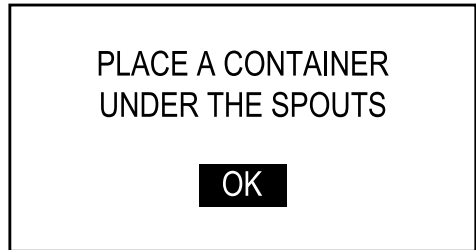

Place a large container under the dispensing spouts (hot water, coffee and cappuccino). Press the "OK" button. The following screen is displayed:

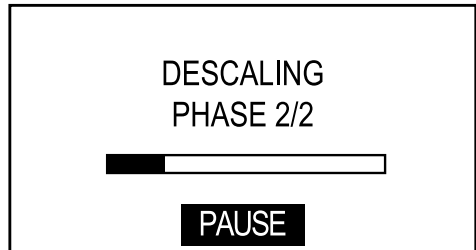

Press the "OK" button to pause the cycle. Press the "OK" button again to resume the cycle. Once the cycle ends, the screen below appears:

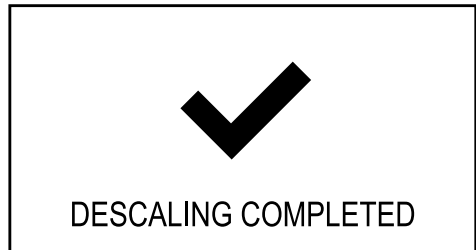

The following screen is displayed:

In case machine descaling is not necessary or when replacing one of the 8 filters, the activation procedure starts from this point.



Select "YES" and press the "OK" button. The following screen is displayed:

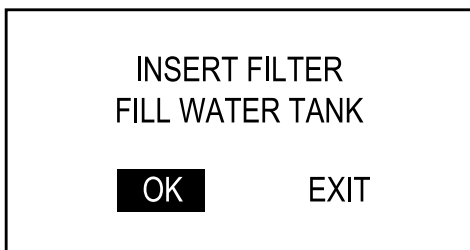

Put the filter into the empty tank. Press it to its limit stop.

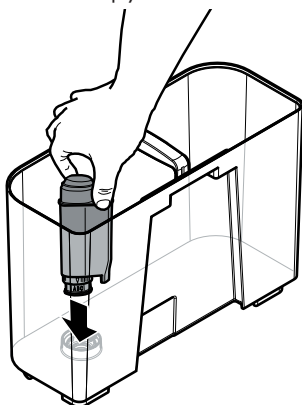

Fill the water tank again up to the MAX level with fresh drinking water. Select "OK" and press the "OK" button. The following screen is displayed:



Place a container under the hot water spout. Select "OK" and press the "OK" button. The filter activates. The following screen is displayed:

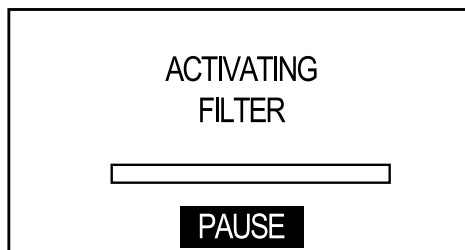

Press the "OK" button to pause the operation. Once the cycle ends, the menu is exited. Fill the water tank again up to the MAX level with fresh drinking water. On the ready machine screen, the water filter icon appears with the 100% percentage to indicate that the filter has been installed.

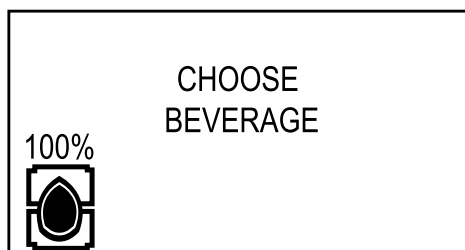

7.3.2 Replacing the water filter

 Replace the water filter as soon as the capacity drops to 0% and the filter icon starts blinking quickly.

 Replace the water filter at least every 3 months, even if the machine has not indicated its need for replacement.

Remove the water filter. Follow the steps indicated in the "Preparing and installing the water filter" section. The operations relating to the descaling phase are not required. You just need to replace the filter and activate the new one. The display automatically updates the number of filters used. Fill the water tank again up to the MAX level with fresh drinking water.

Replacing the filter after using 8 filters

Remove the water filter. Follow the steps indicated in the "Preparing and installing the water filter" section. All operations relating to the descaling phase are required. The display automatically updates the number of filters used. Fill the water tank again up to the MAX level with fresh drinking water.

7.3.3 Water filter removal

If the filter is installed in the machine and you want to remove it, follow the steps below.

Remove the water filter. Descal the machine as described in the "Descaling" section. You do not need to remove the small white filter, since it was removed previously. Once descaled, the machine requests you to press a button.

PRESS A BUTTON

Pressing the button, this screen appears:

ACTIVATE
FILTER?

YES

NONE

Select "NO" and press the "OK" button. Exit the programming mode.

Re-fit the small white filter. Fill the water tank again up to the MAX level with fresh drinking water.

7.4 Adjusting the Coffee Dispensing Spout

Most of the cups and mugs available on the market can be used with this coffee machine. Raise or lower the middle grill to adjust.

The recommended positions are:

- When using small cups.

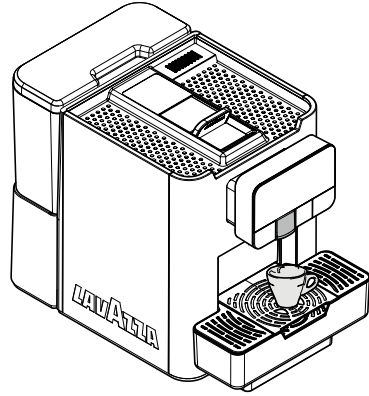

- When using large cups and/or Latte Macchiato cups.

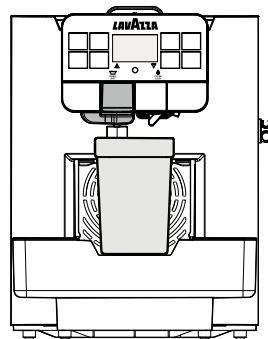
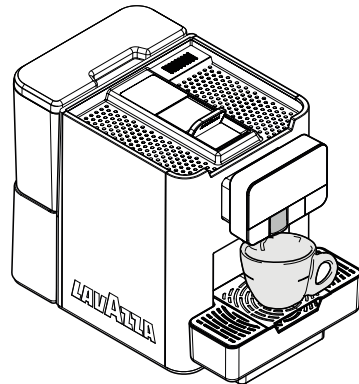

 Do not lower the coffee dispensing spout while brewing coffee.

7.5 Turning on/off the machine

The machine can be turned on/off by pressing the button located to the rear of the machine.

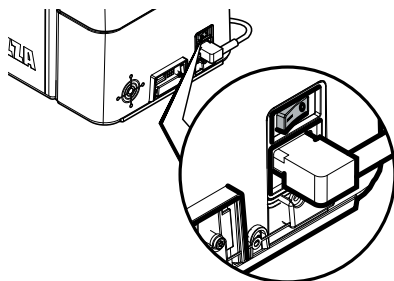

7.6 First Use - Use after a Long Period of Inactivity

Refill the machine. Fill the water tank (see "Filling the water tank"). Connect the plug of the appliance to the mains (see section "Connection to the Electric Network"). For a perfect Espresso: rinse the coffee circuit if using the machine for the first time or after a long period of inactivity.

On first start-up, dispense at least 0.5 l / 17 oz water without any capsule. Open and close the capsule loading tray and press the "Long Coffee" button - with no capsule inserted - to start brewing. Repeat the procedure until the specified quantity is reached. Do not leave water inside the tank for more than 3 days. Do not leave water in the circuit for more than 3 days or, in case this happens, dispense water (with no capsules) before brewing coffee.

These simple operations will allow you to always brew excellent coffee. They have to be performed:

- at first start-up;
- when the machine remains inactive for a long time (more than 2 weeks).

7.6.1 First start-up

Press the power button on the back of the machine to turn it on. The control panel display shows the wording "SYSTEM BOOT" and afterwards you will be requested to press a button.

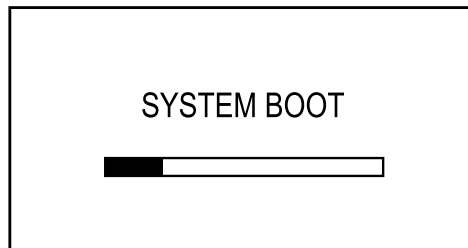

Once you have pressed a button, the control panel display shows "Start water circuit priming?". The "Espresso" button lights up steady.

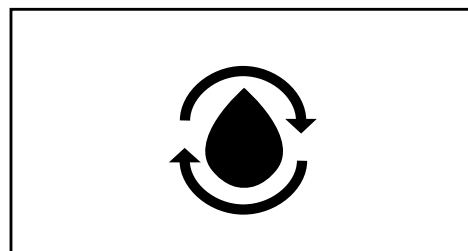
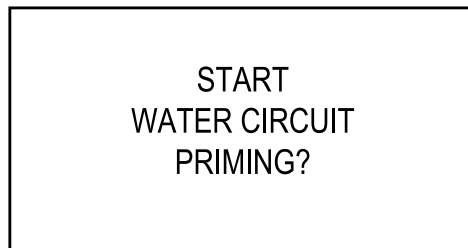

Press the espresso button and the machine starts priming the circuit. The following screen is displayed:

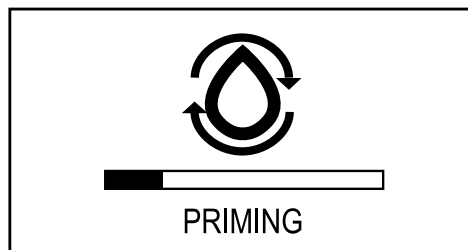

It will then carry out the warm-up and rinse cycle as described in the "Warming-up and rinsing" section.

7.6.2 After a Period of Inactivity

Empty the water tank, wash and rinse it and fill it with fresh water (see section "Filling the Water Tank"). Place a large container under the coffee dispensing spout.

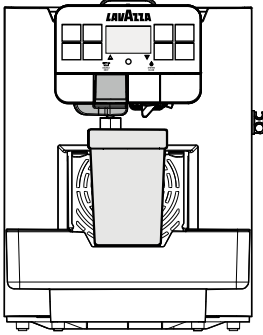

Open and close the capsule loading tray and press the "Coffee 8 Oz." button - with no capsule inserted - to start brewing. The machine starts brewing coffee from the dispensing spout. Wait until brewing has been completed and empty the container. Repeat the brewing cycles 3 times, opening and closing the capsule loading tray each time. Place a container under the hot water dispensing spout.

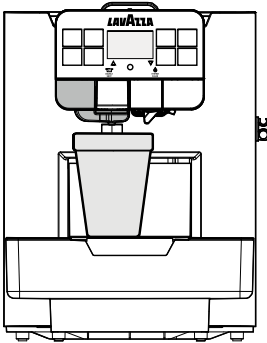

Press the "Hot Water" button. The machine starts dispensing hot water until it stops automatically. Continue dispensing water until the no water icon is displayed.

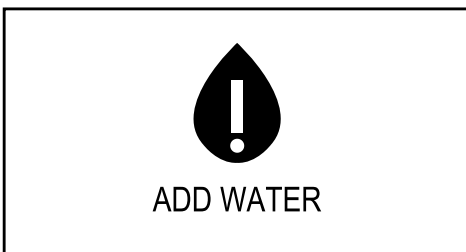

When the hot water dispensing procedure has been completed, empty the container. Fill the water tank again up to the MAX level. The machine is now ready for use.

7.7 Washing the Parts coming into Contact with Food

Rinse all the parts coming into contact with food.

- Thoroughly wash your hands.
- Prepare a chlorine-based, antibacterial disinfecting solution (the products can be purchased at the chemist's) following the concentrations indicated on the product.
- Remove all product containers from the appliance.
- Remove the container lids and product chutes.
- Immerse all these parts in the previously prepared solution.

7.8 Using the Appliance

 Before using the machine, read this manual carefully and make sure users are familiar with the machine.

 After the machine has not been used for a certain time, it is recommended to read section "First Use - Use after a Long Period of Inactivity" again, before using the module again.

The beverage selection modes are indicated in chapter "Operation and Use".

8 PROGRAMMING MENU

 This chapter contains instructions on how to set and change the programming parameters of the appliance.

 Therefore it is necessary to carefully read it and to understand the exact sequence of operations before performing them.

 All the operations described in this chapter must be performed exclusively by the service provider or a specialised technician, who shall organise all the operating steps and use only suitable means to ensure strict compliance with the safety regulations in force.

The specialised technician or the service provider can change some of the machine operating parameters to suit the needs of the users.

8.1 Button Description in Programming Mode

Use the buttons described below to scroll the appliance menus.

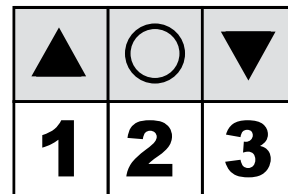
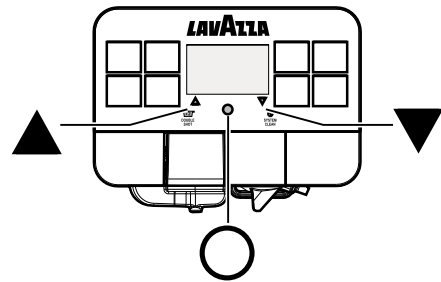

Button 1: Up

It allows you to change the parameters when displayed. (+) value increase

Button 2: OK

It allows you to confirm the parameter/value after changing it.

Button 3: Down

It allows you to change the parameters when displayed. (-) value decrease

8.2 User programming

The structure of the user menu is indicated in section "Structure of the User Menu".

Section "Description of Messages in the User Menu" describes all options in the user menu.

8.2.1 Access to the User Menu

When the machine is "ready for use" the user can access the user menu by pressing the "OK" button.

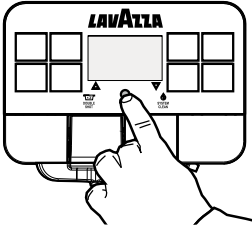

 The menu should be PASSWORD-protected.

 The PASSWORD will not be requested if set to the 0000 value. It should be changed upon first use to prevent unauthorised access. After this change, the password must be entered each time the display shows:

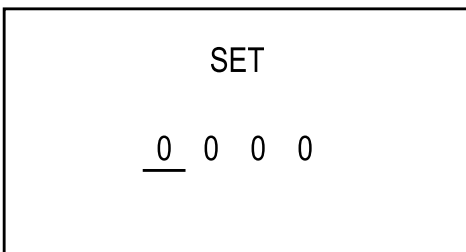

 In case you do not enter the password within 4 seconds the machine goes back to the previous screen.

See the "Password setting" section to set the PASSWORD. This section describes how to set it.

 If the PASSWORD is forgotten, you can reset it by entering a PUK code. Request the PUK code to Lavazza Technical Service, to be guided through the procedure.

8.2.2 Structure of the User Menu

The main options of the user menu are:

MENU ITEM
CLEAN BREWING UNIT
CLEAN CAPPUCCINATORE
Cappuccinatore Light Clean
Cappuccinatore Complete Clean
Exit
Service Menu
Exit

8.2.3 Description of Messages in the User Menu

MENU ITEM	Description
CLEAN BREWING UNIT	This function allows the user to clean the brew unit using hot water
CLEAN CAPPUCCINATORE	This function allows the user to start the Cappuccinatore cleaning cycle
Cappuccinatore Light Clean	This function allows you to clean the Cappuccinatore with hot water passing through the frothing device system
Cappuccinatore Complete Clean	This function allows you to clean the Cappuccinatore, the milk suction hose and the coffee dispensing spout. Immerse the milk suction hose in clean water for this function.
Exit	This option allows the user to go back to the menu top level
Service Menu	This option allows you to access the Maintenance menu - a 4-digit access code must be entered (if enabled)
Exit	This function indicates the machine "ready for use" mode

8.3 Maintenance programming

The structure of the maintenance menu is indicated in section "Structure of the Maintenance Menu". The section "Description of Messages in the Maintenance Menu" describes all the options in the maintenance menu.

8.3.1 Access to the Maintenance Menu

Proceed as follows to access the machine maintenance menu.

- Press the "OK" button to access the user menu.
- Scroll the user menu until the "Maintenance menu" option.
- Press the "OK" button.

 The above mentioned procedure can only be used to access the maintenance menu when the machine has reached operating temperature

 The menus should be PASSWORD-protected.

 The PASSWORD will not be requested if set to the 0000 value. It should be changed upon first use to prevent unauthorised access.

 After this change, the password must be entered each time the display shows:

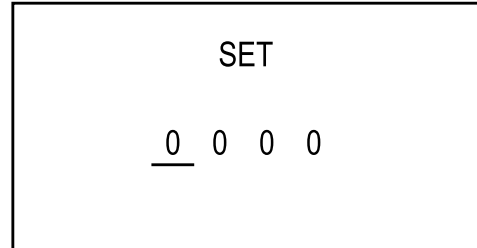

 In case you do not enter the password within 4 seconds the machine goes back to the previous screen.

See the "Password setting" section to set the PASSWORD. This section describes how to set it.

 If the PASSWORD is forgotten, you can reset it by entering a PUK code. Request the PUK code to Lavazza Technical Service, to be guided through the procedure.

8.3.2 Structure of the Maintenance Menu

This menu allows you to manage certain machine operation parameters.

The main options of the maintenance menu are:

MENU ITEM
Statistics
Product Counters
Product Quantities
Descaling counters
Warning Active
Descal. Executed
Tot Desc Refused
Last Desc Refused
(LT) Since Last Desc
Tot Brewed (LT)
Brewed Water (CC)
Brewed Steam Pulses
Pulses To Desc
Exit
Rinsing Counters
Tot BU Rinses
Brews since Last
Tot. Cappucc Cleans
Brews since Last
Exit
Exit
Coffee temperature
Clean Cappuccinatore request
Descaling cycle
Remove the water filter
Empty Drip Tray
Insert Cappuccinatore
Place a Container Under the Spouts
Pour Descaler and Water into Water Tank
Water filter control
filter
Descale Before Activating Filter
Activate Filter?
Insert Filter and Fill Water Tank
Place Container Under the Hot Water Spout
Filter Activated
Exit
Errors management
Errors list
Reset errors
Exit
Save to USB
Save Configuration
Save Statistics
Tech Menu
Exit
Back to Main Screen

8.3.3 Description of Messages in the Maintenance Menu

MENU ITEM	Description
Statistics	This function allows the user to view: <ul style="list-style-type: none"> - Product Counters - Product Qty. - Descaling counters - Rinsing Counters
Product Counters	This function allows the user to view the number of products brewed by the machine, distinguished according to the beverage type
Product Quantities	This function allows the user to view the doses of product, which are stored according to the beverage type. The dose indicates the water quantity processed by the turbine and does not indicate the dose dispensed from the spout
Descaling counters	This function allows the user to view counters and warnings relating to descaling: <ul style="list-style-type: none"> - Warn. Active - Descal. Executed - Tot Desc Refused - Last Desc Refused - (LT) Since Last Desc - Tot Brewed (LT) - Brewed Water (CC) - Brewed Steam Pulses - Pulses To Desc
Warning Active	Indicates that the function warning on the need to perform the descaling cycle is active
Descal. Executed	Indicates the total number of descaling cycles performed by the machine
Tot Desc Refused	Indicates the total number of descaling cycles refused by the user since the machine first start-up
Last Desc Refused	Indicates the total number of descaling cycles refused by the user since the warning appeared
(LT) Since Last Desc	Indicates the number of liters processed since last descaling
Tot Brewed (LT)	Indicates the number of liters processed since the machine first start-up
Brewed Water (CC)	Indicates the liters processed by dispensing water: capsules and hot water, cleaning cycles
Brewed Steam Pulses	Indicates the no. of liters processed by dispensing milk and for the Cappucc. complete cleaning
Pulses To Desc	Indicates the no. of pulses remaining before the next descaling cycle
Exit	This option allows the user to go back to the menu top level
Rinsing Counters	This function allows the user to view the counters relating to the brew unit and Cappuccinatore cleaning cycles performed: <ul style="list-style-type: none"> - Tot. BU Rinses - Brews since Last - Tot. Cappucc. Cleans
Tot BU Rinses	Indicates the number of brew group washing cycles performed
Brews since Last	Indicates the no. of coffee products brewed since last BU cleaning
Tot. Cappucc. Cleans	Indicates the no. of Cappuccinatore cleaning cycles done
Brews since Last	Indicates the no. of milk prod. dispensed since the last Cappuccinatore clean cycle
Exit	This option allows the user to go back to the menu top level
Exit	This option allows the user to go back to the menu top level

MENU ITEM	Description
Coffee temperature	<p>This function allows you to adjust the capsule product temperature (instant products excluded):</p> <ul style="list-style-type: none"> - MAX - MED - MIN <p>Press the OK button on the EXIT option to go back to the top level</p>
Clean Cappuccinatore request	<p>This function allows you to enable the Cappuccinatore cleaning cycle request at the end of each milk product dispensing:</p> <ul style="list-style-type: none"> - OFF: The function is disabled - ON: The function is enabled: after dispensing each milk product the machine prompts the user to perform a Cappuccinatore cleaning cycle. If warning is ignored, request disappears after 5 sec. <p>Press the OK button on the EXIT option to go back to the top level</p>
Descaling cycle	This function allows you to run the descaling cycle.
Remove the water filter	<p>A preliminary instruction is provided when starting descaling</p> <ul style="list-style-type: none"> - OK: go to the next step - EXIT: descaling cancelled; go back to the menu top level
Empty Drip Tray	<p>A preliminary instruction is provided when starting descaling</p> <ul style="list-style-type: none"> - OK: go to the next step - EXIT: descaling cancelled; go back to the menu top level
Insert Cappuccinatore	<p>A preliminary instruction is provided when starting descaling</p> <ul style="list-style-type: none"> - OK: go to the next step - EXIT: descaling cancelled; go back to the menu top level <p>Warning: in case the Cappuccinatore is not properly installed, it will not be possible to proceed with the next step</p>
Place a Container Under the Spouts	<p>A preliminary instruction is provided when starting descaling</p> <ul style="list-style-type: none"> - OK: go to the next step - EXIT: descaling cancelled; go back to the menu top level
Pour Descaler and Water into Water Tank	<p>A preliminary instruction is provided when starting descaling</p> <ul style="list-style-type: none"> - OK: descaling start - EXIT: descaling cancelled; go back to the menu top level <p>Warning: in case there is no water in the tank, it will not be possible to proceed with the next step</p>
Water filter control	This function allows you to control the water filter.

MENU ITEM	Description
filter	<p>This function allows you to control the water filter installation and maintenance. Available options depend on the presence of an already installed filter.</p> <p>If no water filters are installed:</p> <ul style="list-style-type: none"> - OFF: keeps the water filter status unchanged - ON: Allows you to start the water filter activation procedure, going through the "Activate Filter?" screen - EXIT: Returns to "Filter" screen <p>If a water filter is already active and not exhausted: lets you deactivate the water filter</p> <p>If a water filter is already active and not exhausted:</p> <ul style="list-style-type: none"> - RESET: allows you to install a new water filter, going through the "Activate Filter?" screen <p>If a water filter is already active, the "Descale Before Activating Filter" screen is displayed</p>
Descale Before Activating Filter	This screen is displayed for 3 seconds and then it automatically leads you to the "Filter" page
Activate Filter?	<p>A confirmation is requested to continue with the water filter activation:</p> <ul style="list-style-type: none"> - YES: the filter activation procedure starts - No: Returns to the "Water Filter Control" page
Insert Filter and Fill Water Tank	<p>A preliminary instruction is provided when activating the filter:</p> <ul style="list-style-type: none"> - OK: go to the next step - EXIT: Returns to the "Water Filter Control" page
Place Container Under the Hot Water Spout	<p>A preliminary instruction is provided when activating the filter:</p> <ul style="list-style-type: none"> - OK: filter activation start - EXIT: Returns to the "Water Filter Control" page
Filter Activated	This screen is displayed until the user selects OK
Exit	This option allows the user to go back to the menu top level
Errors management	<p>This function allows you to control and display the errors occurred on the machine: - Errors list</p> <ul style="list-style-type: none"> - Reset errors <p>Press the OK button on the EXIT option to go back to the top level</p>
Errors list	<p>This function allows you to view the machine errors: - Error code: displays the number code relating to the error occurred</p> <ul style="list-style-type: none"> - Error index: displays the numerical position of the error in a circular list of 20 positions ordered by time (the most recent on top, the oldest below) - Error text: text description of the type of error
Reset errors	This function resets the error list
Exit	This option allows the user to go back to the menu top level
Save to USB	<p>This function allows you to write the parameters for machine config, the counters and error list on a USB drive.</p> <ul style="list-style-type: none"> - Save configuration - Save statistics <p>Press the OK button on the EXIT option to go back to the top level</p>

MENU ITEM	Description
Save Configuration	<p>This function allows you to save the machine configuration parameters to a USB.</p> <p>The user can select the file name to be saved among the ones proposed on the display: C2317_XX.MEM</p> <p>During this operation the display shows a screen with the message "PLEASE WAIT".</p> <p>In case of a negative result, the display shows a red screen with detailed information regarding the error</p>
Save Statistics	<p>This function allows you to save the counters and the errors list to a USB.</p> <p>The user can select the file name to be saved among the ones proposed on the display: S2317_XX.txt</p> <p>During this operation the display shows a screen with the message "PLEASE WAIT".</p> <p>In case of a negative result, the display shows a red screen with detailed information regarding the error</p>
Tech Menu	This option allows you to access the Technical menu - a 4-digit access code must be entered (if enabled)
Exit	This function returns to the User menu
Back to Main Screen	This function indicates the machine "ready for use" mode

8.4 Technical programming

The structure of the programming menu is indicated in section "Structure of the Programming Menu". The section "Description of Messages in the Programming Menu" describes all the items in the programming menu.

8.4.1 Access to the Technical Menu

Proceed as follows to access programming mode.

- Press the "OK" button to access the user menu.
- Scroll the user menu until the "Maintenance menu" option.
- Press the "OK" button.
- Scroll the maintenance menu until the "Tech Menu" option.
- Press the "OK" button.

 The above mentioned procedure can only be used to access the programming menu when the machine has reached operating temperature

 The menus should be PASSWORD-protected.

 After this change, the password must be entered each time the display shows:

 The PASSWORD will not be requested if set to the 0000 value. It should be changed upon first use to prevent unauthorised access.

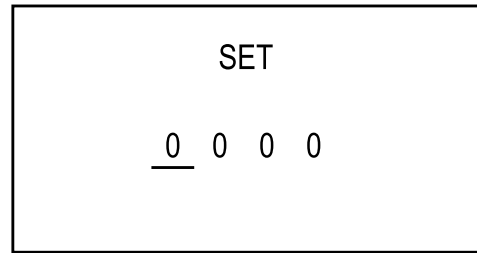

 In case you do not enter the password within 4 seconds the machine goes back to the previous screen.

See the "Password setting" section to set the PASSWORD. This section describes how to set it.

 If the PASSWORD is forgotten, you can reset it by entering a PUK code. Request the PUK code to Lavazza Technical Service, to be guided through the procedure.

8.4.2 Structure of the Technical Menu

This menu allows you to manage certain machine operation parameters.

The main options of the programming menu are:

MENU ITEM
Machine Data
Memo Doses
Set doses
Extended Range
Settings
Recipes management
Exit
Coffee Temperature Range
Prebrewing
.
Language
Stop Brewing Out of Credits
High Speed Milk
Initial/Final Rinsing
Instant prod. Rinse
WATER HARDNESS
Descalc Warning
Display contrast
Capsules alarm
Exit
CREDIT MANAGEMENT
Set Credits Alarm Threshold
Set Credits
Confirm Set Credits
Exit
Stand-by Time
Safety
.
Tech Menu Password
Set
Confirm Password
Disable
Change
Maintenance Menu Password
Set
Confirm Password
Disable
Change
User Menu Password
Set
Confirm Password
Disable
Change
Exit
Restore Factory Settings
Read from USB
Firmware Update
Reboot and Update from SerProg
Reboot and Update from USB
Exit
Exit
Back to Main Screen

8.4.3 Description of Messages in the Technical Menu

MENU ITEM	Description
Machine Data	<p>This function allows you to view:</p> <ul style="list-style-type: none"> - Machine Model - Voltage and Network Frequency - Firmware Version installed on the CPU <p>Press the OK button on the EXIT option to go back to the top level</p>
Memo Doses	<p>This function allows you to access the dose setting functions for single product and the function for dose range extension that can be stored to store coffee and milk products.</p> <p>Press the OK button on the EXIT option to go back to the top level</p>
Set doses	<p>This function allows you to access the product list and change the dose dispensed for each product:</p> <p>Select the desired product and press the OK button to start dispensing it. Once the desired dose has been reached, press the OK button again to confirm the operation Press the OK button on the EXIT option to go back to the top level</p>
Extended Range	<p>This option allows you to increase the dose range that can be stored for each product, except for Frothed Milk. Selecting "Yes" the range will store the doses inside the following ranges:</p> <ul style="list-style-type: none"> - coffee prod.: 20cc / 0.68oz ÷ 300cc / 10oz - milk products: 10cc / 0.34oz ÷ 320cc / 10.8oz <p>Press the OK button on the EXIT option to go back to the top level</p>
Settings	<p>This function allows you to access certain machine configuration parameters</p>
Recipes management	<p>This function allows you to individually enable or disable recipes that can be dispensed by the machine</p>
Exit	<p>This option allows the user to go back to the menu top level</p>
Coffee Temperature Range	<p>This function allows you to select the temp. range within which capsule beverages must be brewed (instant products excluded):</p> <ul style="list-style-type: none"> --> -4 : 4°C / 39.2°F less compared to the default temperature --> -2: 2°C / 35.6°F less compared to the default temperature --> 0: default temperature -->+2: 2°C / 35.6°F more compared to the default temperature -->+4: 4°C / 39.2°F more compared to the default temperature <p>Press the OK button on the EXIT option to go back to the top level</p>

MENU ITEM	Description
Prebrewing	<p>Pre-brewing entails soaking the coffee pod before brewing, in order to bring out its full aroma.</p> <ul style="list-style-type: none"> - No: pre-brewing disabled - Short: 1 sec. pre-brewing - Medium: 2.5 sec. pre-brewing - Long: 3 sec. pre-brewing <p>Press the OK button on the EXIT option to go back to the top level</p>
Language	<p>This option allows the user to select the desired language among:</p> <ul style="list-style-type: none"> - ITALIAN - ENGLISH - GERMAN - FRENCH - SPANISH - PORTUGUESE - POLISH - RUSSIAN - SLOVENIAN <p>Press the OK button on the EXIT option to go back to the top level</p>
Stop Brewing Out of Credits	<p>This function allows the user to adjust machine operation when the credits have been used up.</p> <ul style="list-style-type: none"> - OFF: the user can dispense products even with no more credits - ON: the user cannot dispense products with no credits. The products cannot be selected <p>Press the OK button on the EXIT option to go back to the top level</p>
High Speed Milk	<p>This function allows the user to dispense mixed products (milk and coffee) quicker, by simultaneously enabling the milk and coffee preparation:</p> <ul style="list-style-type: none"> - OFF function not enabled - ON: function enabled <p>Press the OK button on the EXIT option to go back to the top level</p>
Initial/Final Rinsing	<p>This function allows the user to enable or disable the rinsing cycle when the machine enters or exits from the stand-by mode.</p> <ul style="list-style-type: none"> - OFF function not enabled - ON: function enabled <p>Press the OK button on the EXIT option to go back to the top level</p>
Instant prod. Rinse	<p>This setting determines whether the brew unit rinse cycle - after brewing an instant beverage - is enabled or not</p> <ul style="list-style-type: none"> - OFF: function not enabled - ON: function enabled <p>Press the OK button on the EXIT option to go back to the top level</p>

MENU ITEM	Description
WATER HARDNESS	<p>This function allows you to adjust water hardness:</p> <ul style="list-style-type: none"> - LEVEL 1: very soft water - LEVEL 2: soft water - LEVEL 3: hard water - LEVEL 4: Very hard water <p>For more details, see the "Measuring and Adjusting Water Hardness" chapter.</p> <p>Press the OK button on the EXIT option to go back to the top level</p>
Descal Warning	<p>This function allows you to set the alarm indicating the need for machine descaling. Damage resulting from failure to descale the machine is not covered by warranty.</p> <ul style="list-style-type: none"> - OFF: function not enabled - ON: function enabled <p>Press the OK button on the EXIT option to go back to the top level</p>
Display contrast	<p>This function allows you to adjust the contrast of the display to better view the messages.</p> <p>The user, by means of the navigation arrows, can change the display contrast settings. The modification of the contrast level is shown by the bar.</p> <p>The user must press the OK button to confirm the choice and go back to the menu top level.</p>
Capsules alarm	<p>This function allows you to enable/disable the alarm warning the user that the capsule drawer needs to be emptied.</p> <ul style="list-style-type: none"> - OFF: function not enabled - ON: function enabled <p>Press the OK button on the EXIT option to go back to the top level</p> <p>NOTE: disabling this alarm may cause machine malfunctions, since the capsules may block the Brew unit.</p>
Exit	<p>This option allows the user to go back to the menu top level</p>
CREDIT MANAGEMENT	<p>This menu option allows you to use the credit management functions for:</p> <ul style="list-style-type: none"> - Setting the activation threshold of credit alarms - Setting the available credits
Set Credits Alarm Threshold	<p>This function allows you to set a threshold below which the machine warns the user that the credits are running out.</p> <p>The settable thresh. are:</p> <ul style="list-style-type: none"> - 0 CREDITS: the alarm is disabled - < 5 CREDITS: the machine warns the user when there are only 5 credits available - < 10 CREDITS: the machine warns the user when there are only 10 credits available - < 20 CREDITS: the machine warns the user when there are only 20 credits available - < 50 CREDITS: the machine warns the user when there are only 50 credits available <p>Press the OK button on the EXIT option to go back to the top level</p>

MENU ITEM	Description
Set Credits	<p>This function allows credit charging in the machine. The user must set the indicated number, increasing or decreasing it by means of the navigation buttons. By pressing the OK button the cursor under the digit is moved to the right. By pressing the OK button, after the fourth digit you access the "Confirm Set Credits" screen</p>
Confirm Set Credits	<p>Press OK on one of the following options:</p> <ul style="list-style-type: none"> - YES: confirm and save the set credits - No: reset the number of credits and go back to the charging screen <p>Press the OK button on the EXIT option to go back to the top level</p>
Exit	<p>This option allows the user to go back to the menu top level</p>
Stand-by Time	<p>This function allows you to adjust the time after which the machine must go into "stand-by" mode. In case it is not used:</p> <ul style="list-style-type: none"> - NO STANDBY: the machine is always active - 30 MIN: the machine goes in standby after 30 min. inactivity - 60 MIN: the machine goes in standby after 60 min. inactivity - 180 MIN: the machine goes in standby after 180 min. inactivity <p>Press the OK button on the EXIT option to go back to the top level</p>
Safety	<p>This function allows you to manage the passwords to access the various machine menus:</p> <ul style="list-style-type: none"> - Tech Menu Password - Maintenance Menu Password - User Menu Password
Tech Menu Password	<p>Using this option, the user can manage the Tech Menu password:</p> <ul style="list-style-type: none"> - SET: you can access this option if the password is not set - DISABLE: this option is only displayed if a password is already set - CHANGE: Press the OK button on the EXIT option to go back to the top level
Set	<p>This function allows you set the 4-digit code to access the technical menu. The user must set the desired number, increasing or decreasing it by means of the navigation buttons. By pressing the OK button the cursor under the digit is moved to the right. By pressing the OK button, after the fourth digit you access the "Confirm Password" screen.</p> <p>Press the OK button on the EXIT option to go back to the top level</p>
Confirm Password	<p>Press OK on one of the following options:</p> <ul style="list-style-type: none"> - YES: confirm and save the set credits - No: go back to the password entry screen <p>Press the OK button on the EXIT option to go back to the top level</p>
Disable	<p>Using this option, the user can disable the set password. In this case the password is set to "0000" by default.</p>
Change	<p>Using this option, the user can change the set password:</p>

MENU ITEM	Description
Maintenance Menu Password	<p>Using this option, the user can manage the Maintenance Menu password</p> <p>- SET: you can access this option if the password is not set</p> <p>- DISABLE: this option is only displayed if a password is already set</p> <p>- CHANGE: Press the OK button on the EXIT option to go back to the top level</p>
Set	<p>This function allows you set the 4-digit code to access the Maintenance menu</p> <p>The user must set the desired number, increasing or decreasing it by means of the navigation buttons.</p> <p>By pressing the OK button the cursor under the digit is moved to the right.</p> <p>By pressing the OK button, after the fourth digit you access the "Confirm Password" screen.</p> <p>Press the OK button on the EXIT option to go back to the top level</p>
Confirm Password	<p>Press OK on one of the following options:</p> <p>- YES: confirm and save the set credits</p> <p>- No: go back to the password entry screen</p> <p>Press the OK button on the EXIT option to go back to the top level</p>
Disable	<p>Using this option, the user can disable the set password:</p> <p>In this case the password is set to "0000" by default.</p>
Change	<p>Using this option, the user can change the set password:</p>
User Menu Password	<p>Using this option, the user can manage the User menu password:</p> <p>- SET: you can access this option if the password is not set</p> <p>- DISABLE: this option is only displayed if a password is already set</p> <p>- CHANGE: Press the OK button on the EXIT option to go back to the top level</p>
Set	<p>This function allows you set the 4-digit code to access the User menu</p> <p>The user must set the desired number, increasing or decreasing it by means of the navigation buttons.</p> <p>By pressing the OK button the cursor under the digit is moved to the right.</p> <p>By pressing the OK button, after the fourth digit you access the "Confirm Password" screen.</p> <p>Press the OK button on the EXIT option to go back to the top level</p>
Confirm Password	<p>Press OK on one of the following options:</p> <p>- YES: confirm and save the set credits</p> <p>- No: go back to the password entry screen</p> <p>Press the OK button on the EXIT option to go back to the top level</p>
Disable	<p>Using this option, the user can disable the set password:</p> <p>In this case the password is set to "0000" by default.</p>
Change	<p>Using this option, the user can change the set password:</p>
Exit	<p>This option allows the user to go back to the menu top level</p>
Restore Factory Settings	<p>This function restores the factory configuration settings when a malfunction occurs.</p> <p>Using the OK button the user can confirm this selection.</p>

MENU ITEM	Description
Read from USB	This function allows you to read and import a parameter configuration onto the machine. During this operation the display shows a screen with the message "PLEASE WAIT". In case of a negative result, the display shows a red screen with detailed information regarding the error
Firmware Update	Using this option the user can select two different modes to download the firmware: <ul style="list-style-type: none"> - Reboot and Update from SerProg - Reboot and Update from USB NOTE: further information on these options are provided in the specific manuals
Reboot and Update from SerProg	Using this option the user can download the firmware using the SerProgr SAECO Vending kit. The selection of this option using the OK button will restart the machine
Reboot and Update from USB	Using this option the user can download the firmware via a correctly prepared USB flash drive. The selection of this option using the OK button will restart the machine
Exit	This option allows the user to go back to the menu top level
Exit	This function returns to the Maintenance menu
Back to Main Screen	This function indicates the machine "ready for use" mode

8.4.4 Password setting

The PASSWORD must be set by the service provider in order to prevent access by unauthorised personnel who could change the machine settings and cause malfunctions.

Three passwords can be set to access the three different machine menus.

To set the PASSWORD, proceed as follows:

Switch to machine programming mode as described in section "Access to the Technical Menu".

Press the "Down" button until the following menu is displayed:

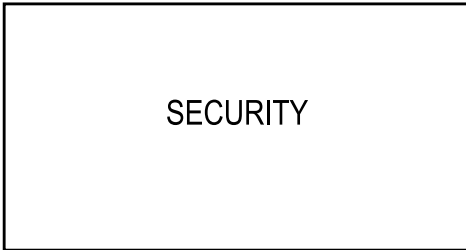

Press the "OK" button to enter the submenu of the selected option. The following screen is displayed:



Press the "Down" or "Up" button to select the menu for which to set the password. Press the "OK" button to confirm. The following screen is displayed:

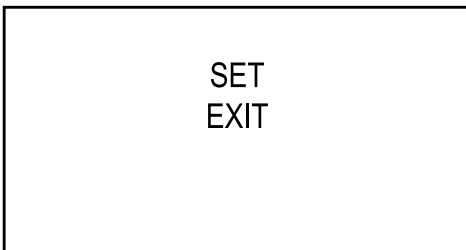

Press the "Down" or "Up" button to select the "Set" option. Press the "OK" button to confirm and access password programming. The following screen is displayed:

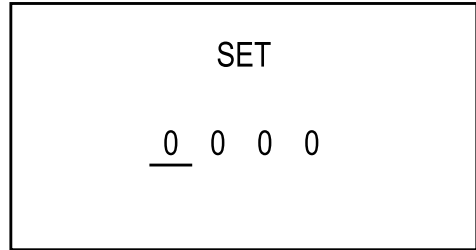

To enter the password:

Press the "Up" or "Down" button to set the desired number. Press the "OK" button to move to the next number.

Repeat the steps until the set password has been entered. Entered the last number the screen below appears:

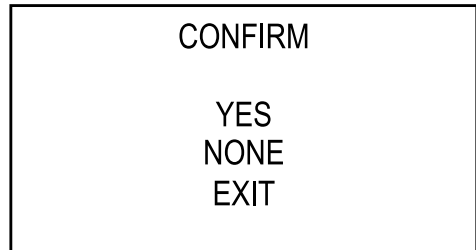

Press the "Up" or "Down" button to select the "Yes" option and confirm the password.

In case you want to change an already set password follow the same procedure. The following screen will be displayed:



Select "Disable" to cancel the previously set password, or select "Change" to modify the previously set password.

8.4.5 Setting Credits

Credits can be set to control sales. To set the credits, proceed as follows:

Switch to machine programming mode as described in section "Access to the Technical Menu".

Press the "Down" or "Up" button until the following menu is displayed:



Press the "OK" button to confirm and access the menu.

Press the "Down" or "Up" button until the following menu is displayed:

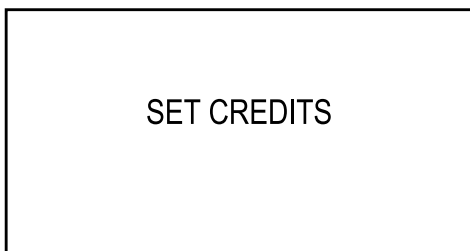

The "SET CREDITS" option is displayed, which will allow the number of credits to be set manually.

Press the "OK" button to confirm and access the credit charging page.



To charge credits:

Press the "Up" or "Down" button to set the desired number.

Press the "OK" button to move to the next number.

Repeat the steps until the desired credits have been entered. Entered the last number the screen below appears:

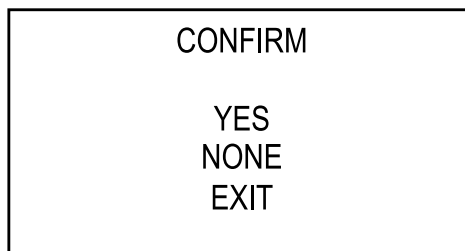



Press the "Up" or "Down" button to select the "Yes" option and confirm.

To exit, use the "Up" or "Down" buttons to scroll until the "Exit" option.

9 OPERATION AND USE

 The use by children older than 8 years or by persons with reduced physical, mental or sensory abilities or with lack of experience and skills is allowed, provided that they are supervised or instructed on how to use the appliance correctly and that they understand the hazards involved.

 Children must not play with the appliance. Children must not carry out any cleaning and maintenance operations without being monitored.

 For hygienic reasons, after the machine has not been used for a long time, it is recommended to thoroughly rinse the circuit.

9.1 Warm-up and Rinsing

Upon start-up, the machine starts the warm-up phase to perform a cleaning cycle. The display shows:

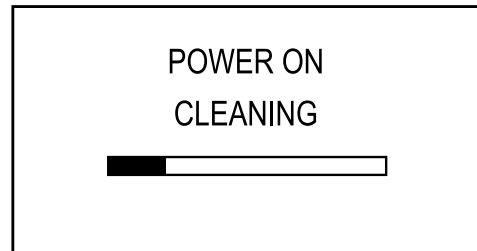

The brew unit and the Cappuccinatore - if fitted - will dispense hot water.

The cycle cannot be interrupted. Then the machine will be ready for use.

Upon product dispensing request the machine may perform a warm-up cycle, if necessary.

The display shows:

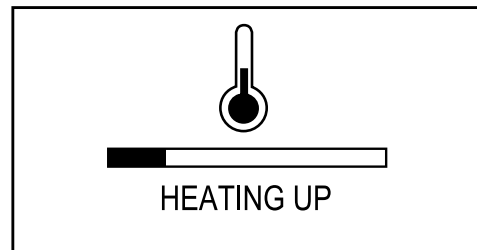

9.2 Rinse and Self-cleaning

The cycle allows the coffee and milk circuits to be rinsed with fresh water.

This cycle is only carried out during the warm-up phase in the following cases:

- Upon machine start-up, when it is cold.
- During the stand-by preparation phase, if at least one coffee-based or milk-based product has been brewed.

9.3 Loading capsules

 To dispense the desired products only LAVAZZA BLUE or LAVAZZA EXPERT compatible capsules have to be used.

 Do not use LAVAZZA BLUE or LAVAZZA EXPERT not compatible capsules, coffee beans, ground and/or instant coffee.

 The capsules supplied with this machine are single-use capsules and each of them should be used for one brewing cycle only.

 Capsules should not be reused to brew two or more products.

To insert the capsule, the loading tray must be opened by pushing it inwards as far as it will go.

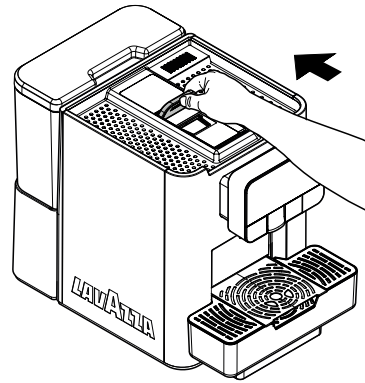

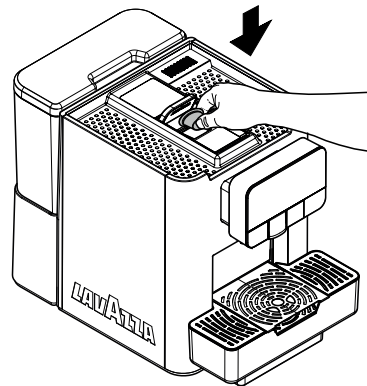

 Do not force the tray beyond its limit.

Pick up a single capsule and insert it into its seat.





 The capsule should be inserted as shown in the figure.

 The capsule must be inserted into place without the use of any tools.

 The capsule cannot be removed when inside the compartment.

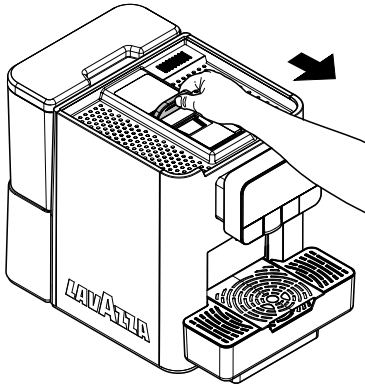
When the capsule is correctly placed, close the tray.



 If you encounter resistance when closing the tray, check the capsule position.

 Do not insert your fingers or any other object other than Lavazza BLUE or LAVAZZA EXPERT capsules into the tray.

The capsule is now inserted, and the user may select the desired beverage.

9.4 Using the suction tube

Connect the suction hose to the Cappuccinatore and insert the other end of the hose into the slot of the clip as shown in the figure.

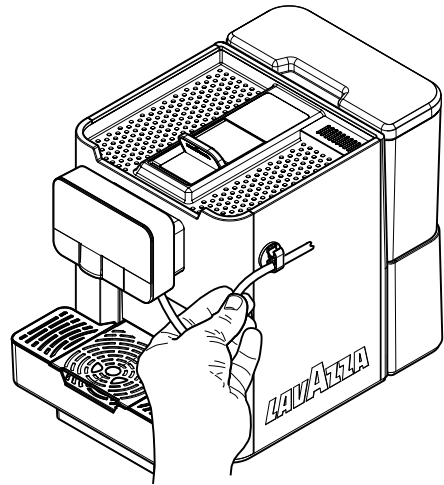

Fix the suction hose to the open slot as shown in the figure.

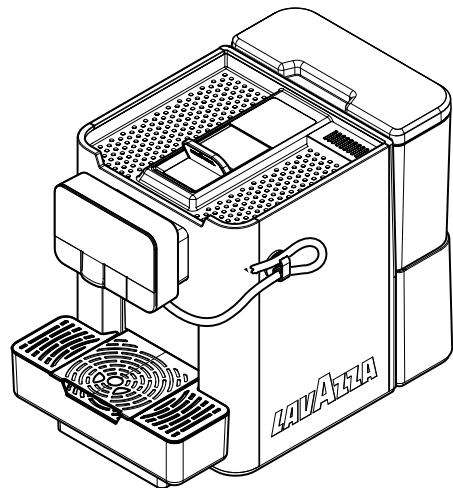

At this point the suction hose is in the non-use position.

To suck the milk from a container, remove the hose from the open slot of the clip and insert it into the container.

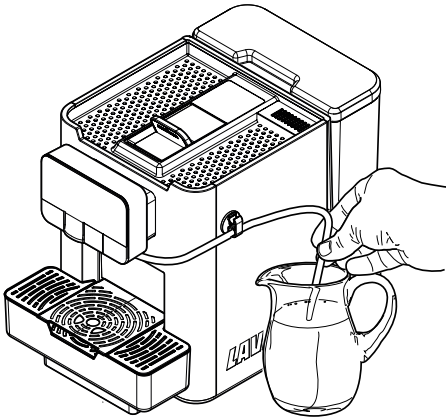

If you want to suck milk from a container inside the fridge, pull out the hose from both slots of the clip and insert it into the fridge hole.

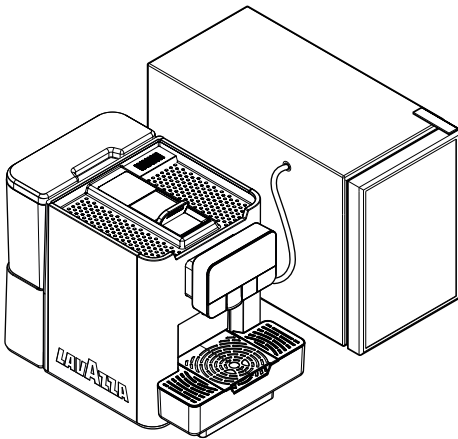

9.5 Brewing a single coffee / product

Before brewing the coffee/product, ensure that:

- The machine is ready for use
- The capsule is correctly placed
- A cup and/or mug suitable for the desired product is placed under the dispensing spout.

 In case you press a beverage button when the capsule tray is open, the display will indicate to close the tray.

CLOSE
SLIDING
DOOR

 If you close the tray within the suggested time the previously selected product is brewed. Otherwise, the wording "Brewing failed" is displayed.

BREWING
FAILED

The machine checks whether a capsule is inserted by detecting the opening and closing of the capsule tray. In case no capsule is inserted, a display message will prompt the user to insert one. After closing the capsule tray, press the button again to dispense the selected product. The user can stop product dispensing when the blinking LED light of the selected product becomes steady on. The machine automatically disposes of the capsule into the capsule drawer.

Brewing an Espresso

Press the "Espresso" button. The machine automatically brews an espresso.

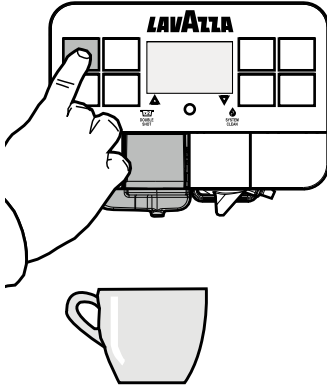

The display shows the brewing stage.



Product brewing stops automatically when the preset level is reached. Finished the brew the display shows:



Brewing a long coffee

Press the "Long" button. The machine automatically brews a long coffee.

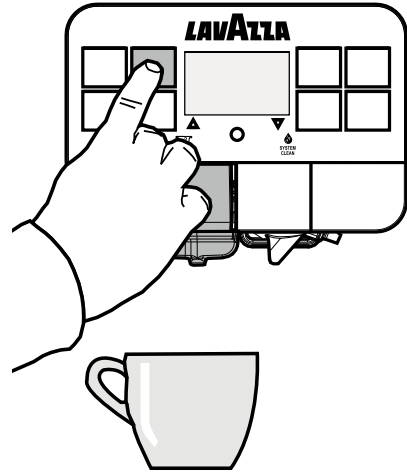

The display shows the brewing stage.



Product brewing stops automatically when the preset level is reached. Finished the brew the display shows:



Brewing an 8 oz coffee

Press the "Coffee 8 Oz." button. The machine automatically brews an 8 oz coffee.

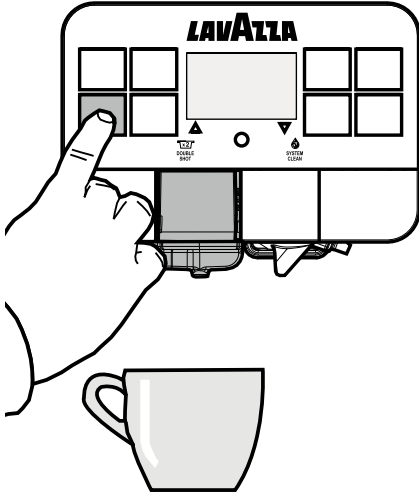

The display shows the brewing stage.

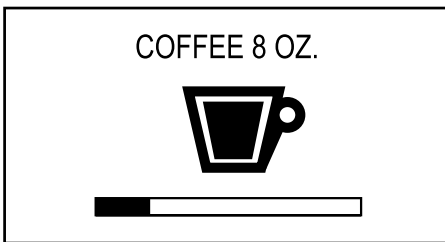



Product brewing stops automatically when the preset level is reached. Finished the brew the display shows:

**Brewing coffee with a dash of milk**

 Danger of burning!
Dispensing may be preceded by small jets of hot water.

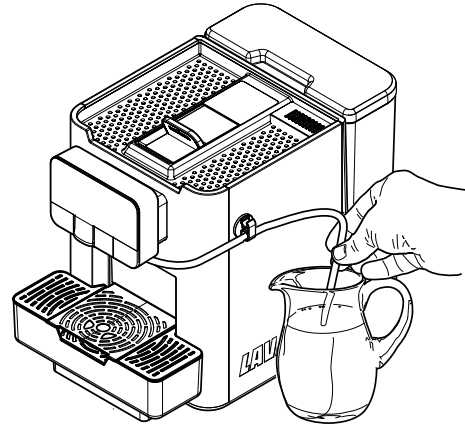
Insert the suction hose into the milk container.



 For hygienic reasons, make sure that the outer surface of the suction hose is clean.

Press the "Coffee with a dash of milk" button. The machine automatically brews the beverage.

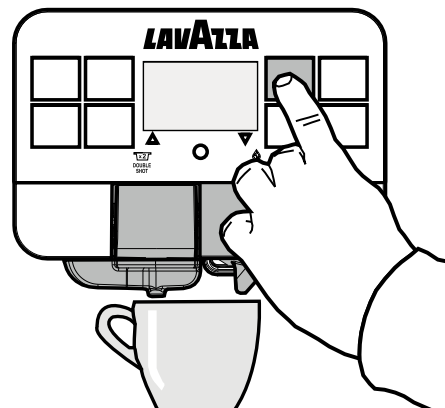

The display shows the brewing stage.



Product brewing stops automatically when the preset level is reached.

Finished the brew the display shows:





If the "Clean Cappuccinatore Request" option in the maintenance menu has been set to "ON", the display shows the wording "Light Clean? YES - NO" once the milk-based product has been dispensed to remind you that the Cappuccinatore should be rinsed. Refer to the "Cleaning the Cappuccinatore (After each Use)" section to carry out this operation.

Brewing Cappuccino

 **Danger** of burning! Dispensing may be preceded by small jets of hot water.

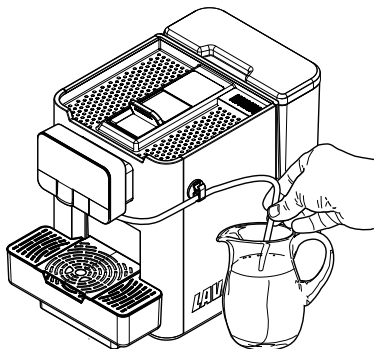
Insert the suction hose into the milk container.



 For hygienic reasons, make sure that the outer surface of the suction hose is clean.

Press the "Cappuccino" button. The machine automatically brews the beverage.

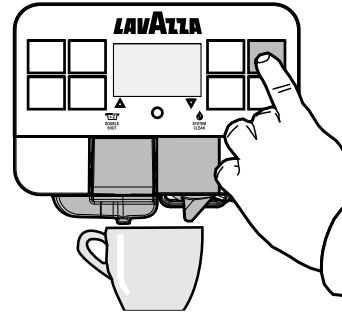

The display shows the brewing stage.



Product brewing stops automatically when the preset level is reached. Finished the brew the display shows:





If the "Clean Cappuccinatore Request" option in the maintenance menu has been set to "ON", the display shows the wording "Light Clean? YES - NO" once the milk-based product has been dispensed to remind you that the Cappuccinatore should be rinsed. Refer to the "Cleaning the Cappuccinatore (After each Use)" section to carry out this operation.

Dispensing Milk

 Danger of burning!
Dispensing may be preceded by small jets of hot water.

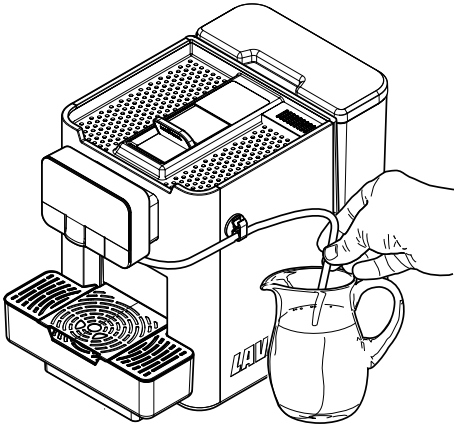
Insert the suction hose into the milk container.



 For hygienic reasons, make sure that the outer surface of the suction hose is clean.

Press the "Milk" button. The machine automatically brews the beverage.

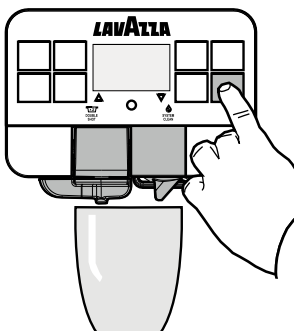

The display shows the brewing stage.

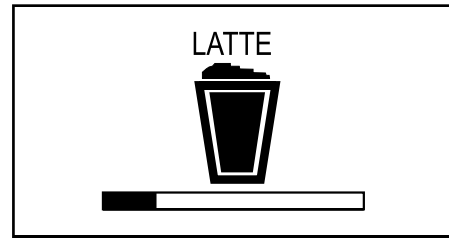

Product brewing stops automatically when the preset level is reached. Finished the brew the display shows:



If the "Clean Cappuccinatore Request" option in the maintenance menu has been set to "ON", the display shows the wording "Light Clean? YES - NO" once the milk-based product has been dispensed to remind you that the Cappuccinatore should be rinsed.

Refer to the "Cleaning the Cappuccinatore (After each Use)" section to carry out this operation.

Brewing a hot beverage

 This product can be correctly brewed only if you are using a capsule with instant product (i.e. barley).

Press the "Hot Beverage" button. The machine automatically brews the instant product.

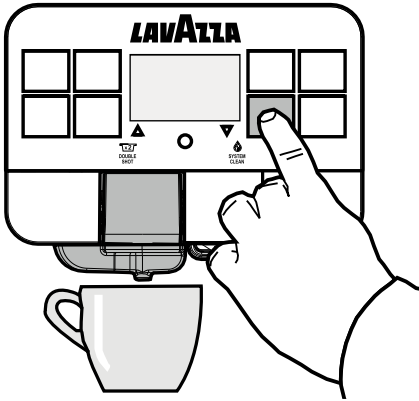

The display shows the brewing stage.

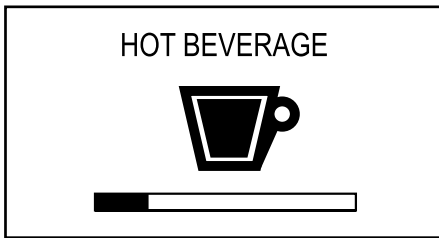

Product brewing stops automatically when the preset level is reached. Finished the brew the display shows:



9.6 Dispensing hot water

- ⚠ Danger of burning!
Dispensing may be preceded by small jets of hot water and/or steam.
- ⚠ The hot water dispensing spout may reach high temperatures: never touch it with your bare hands.

Ensure the machine is ready for use before dispensing hot water. Place a container under the hot water dispensing spout.

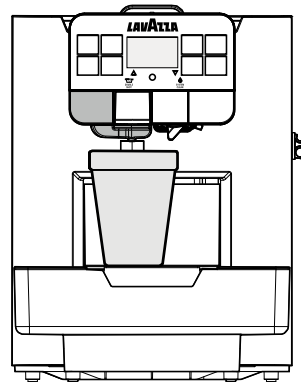

Press the "Hot Water" button. After a few moments hot water will be dispensed from the hot water dispensing spout.

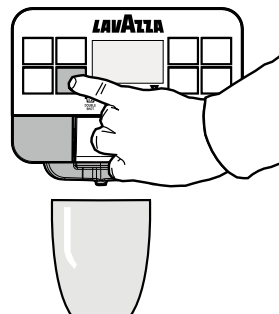

The display will show:

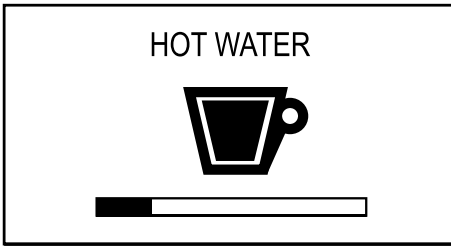

Product brewing stops automatically when the preset level is reached. The user can stop product dispensing once the desired quantity is reached by pressing the "Hot Water" button again.

9.7 Brewing "Double Shot" products

 This product can be correctly brewed only if you are using a double dose capsule.

Insert a double dose capsule as described in the "Loading capsules" section.

Press the "Up"/"Double Shot" button to brew the "Double shot beverages".

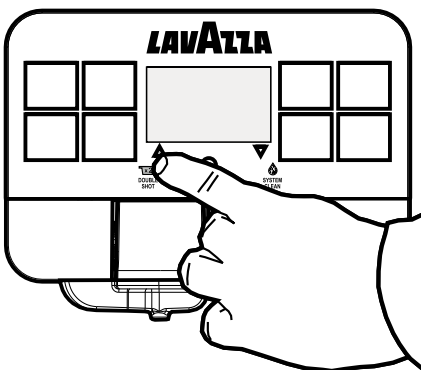

Only the available "Double shot beverages" will be activated on the keyboard.

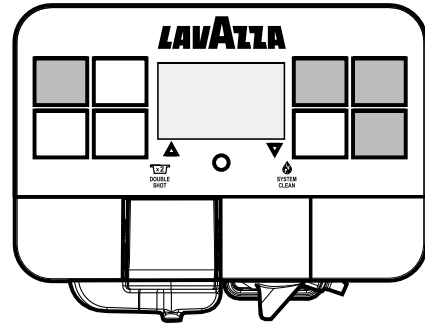

Select a beverage among those available.

We select an espresso, for example. Press the "Espresso" button. The machine automatically brews a double shot espresso (x2).

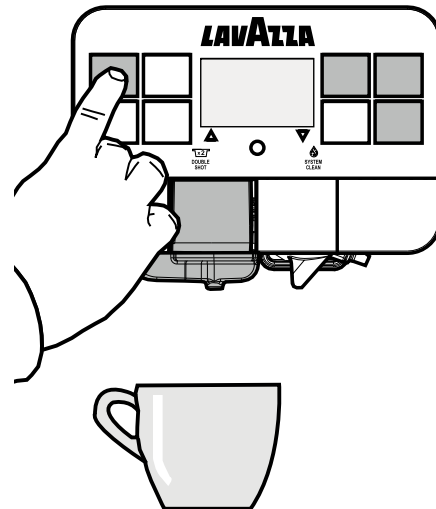

The display shows the brewing stage.



Product brewing stops automatically when the preset level is reached. Finished the brew the display shows:

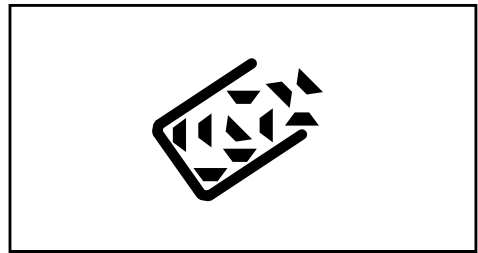
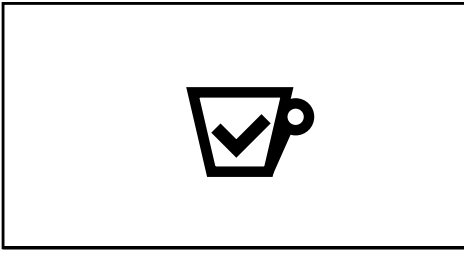

9.8 Emptying the capsule drawer and drip tray

 This operation must be performed with the machine turned on.

The machine will indicate when the capsule drawer has reached its maximum capacity for holding capsules. The first warning alerts the user that the capsule drawer must be emptied, but the machine can still be used to brew coffee. The display will show:

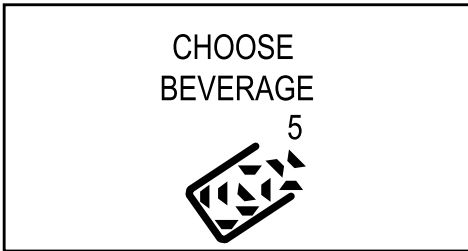

If the capsules are not removed from the drawer after several brewing cycles, the machine will stop. The display will show:

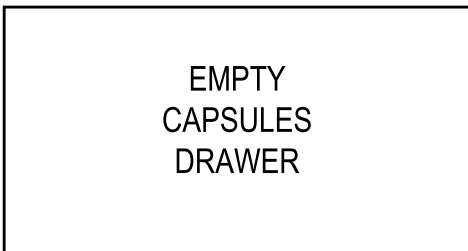

In order to brew coffee, the capsule drawer must be emptied of used capsules. Remove the drip tray and the capsule drawer.

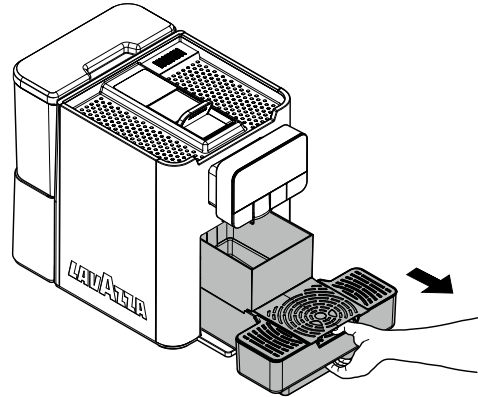

When removing the capsule drawer the machine will inform the user that the alarm will be reset within 5 seconds.

 If the capsule drawer is inserted during this time frame, the machine will not brew coffee.

After 5 seconds the machine prompts the user to insert the capsule drawer back into place. When the drip tray and the capsule drawer are removed and emptied, the display will show:

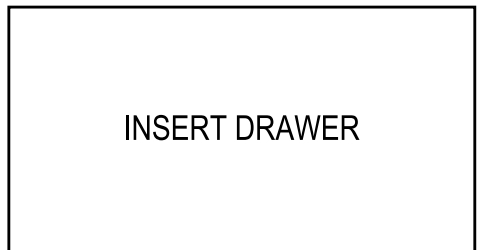

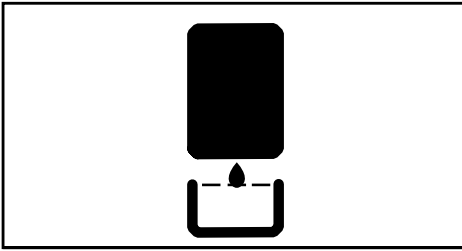

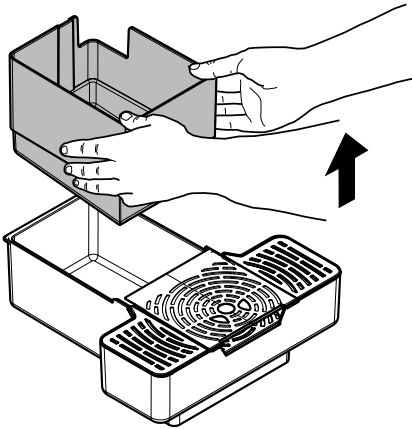

Lift the capsule drawer.



Empty the capsule drawer and the drip tray.

 The capsule drawer also contains liquid coffee or other beverage residues as a result of dripping after brewing.

 Liquids and capsules must be disposed of separately, as appropriate.

 Before reinserting the capsule drawer into the machine, ensure that it is correctly placed and that the grill is properly arranged.

 If the drip tray is inserted without the capsule drawer the machine will not brew products.

After emptying, insert the capsule drawer. The display will show:

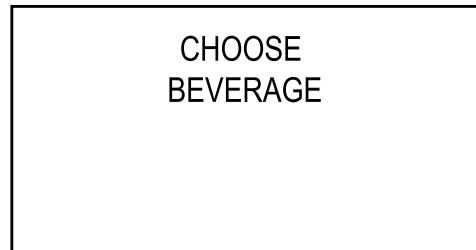

The machine is now ready to brew coffee.

10 CLEANING AND MAINTENANCE

 Before performing any maintenance and/or cleaning operation, unplug the power cord.

 The Manufacturer is not liable for damage or malfunctions caused by a wrong or lack of maintenance.

 Avoid using chlorine-based tablets so as to prevent oxidation phenomena inside the appliance.

10.1 General Notes for Correct Operation







 Non-removable components and the machine itself must be cleaned, when not differently specified, only by using cold or lukewarm water, with a non-abrasive sponge and a damp cloth.

 Never use direct jets of water onto the appliance and/or its components.

Periodic maintenance and cleaning will keep the machine in good working order for a longer time and ensure compliance with basic hygienic standards.

Follow the instructions and timing indicated in the "MAINTENANCE SCHEDULE" to ensure correct operation of the appliance.

10.2 Cleaning and Scheduled Maintenance

-  All parts requiring cleaning are easily accessible, so no tools are needed.
-  All parts must be washed with lukewarm water only and without using detergents or solvents that could change their shape or performance.
-  All removable parts - except for the Cappuccinatore - cannot be washed in the dishwasher.
-  Once they have been properly disassembled, the milk Cappuccinatore components can be washed in the dishwasher maximum once a week at a temperature not exceeding 70°C / 158°F.
-  Do not clean the electric parts with wet cloths and/or with degreasing detergents. Remove any dust residues with a jet of dry compressed air or with an antistatic cloth.
-  Thoroughly clean the Cappuccinatore every day, after each use. Clean with a detergent specifically designed for milk products. Remove the Cappuccinatore once the cleaning cycle is complete. Once you have disassembled it, wash each single part and make sure to remove any milk residues.

10.2.1 Maintenance Schedule

Operation to be carried out	A	B	C	D
Emptying and cleaning the capsule drawer:	yes	yes	-	yes
Cleaning the capsule loading tray.	-	yes	-	-
Water tank cleaning.	-	yes	-	yes
Rinsing.	-	-	yes	-
Cappuccinatore thorough cleaning.	-	-	-	yes
Descaling.	yes	-	-	-

- A** When an alert is shown
- B** When the water tank is filled, or every week
- C** As required
- D** Every day

 The machine and its parts should in any case be cleaned every week.

 The appliance and its parts should be cleaned and washed following a period of inactivity.

10.2.2 Cleaning the drip tray and the capsule drawer

The capsule drawer is to be emptied and cleaned whenever indicated by the machine. However, it is recommended to empty it daily. To carry out this operation, see the "Emptying the capsule drawer and the drip tray" section.

Anyway, whenever servicing the machine, it is best to remove and clean the capsule drawer.

At this time, it is also advisable to clean the cup and mug holder grills.

10.2.3 Cleaning the capsule loading tray

Check the status of the capsule loading tray, and if necessary clean it with a damp cloth.

 Do not use detergents to clean the tray since it might be difficult to remove possible residues.

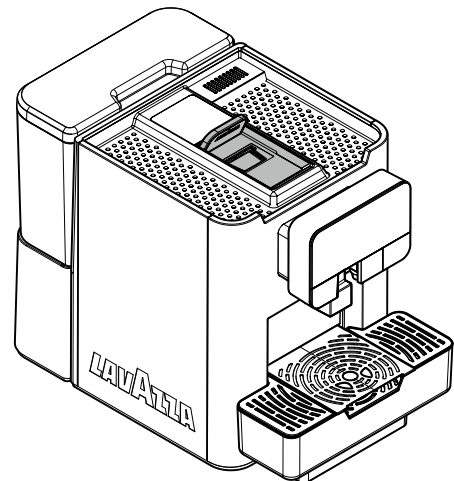

Check that the tray can slide freely.

10.2.4 Cleaning the Water Tank

Remove the lid from the water tank.

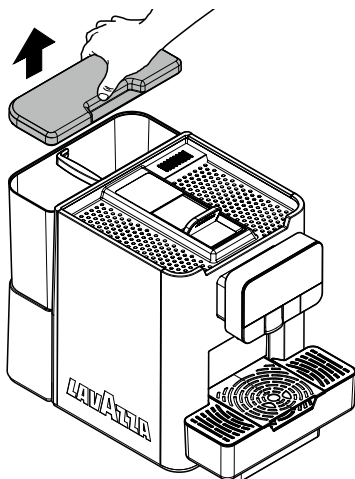

Remove the tank; lift it using the inside handle.

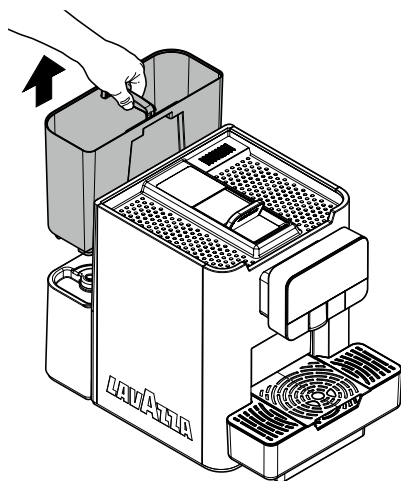

Use a non-abrasive detergent to clean it. Rinse with fresh water and dry carefully.

10.2.5 Rinsing internal circuits

The internal circuits should be rinsed at least once a day. In order to perform this operation, see the "Rinse and Self-cleaning" section.

10.2.6 Cleaning the Cappuccinatore (After Each Use)

⚠ Failure to clean the Cappuccinatore after use with milk may cause proliferation of bacteria which may be harmful for the user.

⚠ The milk circuit must be quickly rinsed after use to always ensure proper hygiene.

The Cappuccinatore must be washed and cleaned every time it is used. The lack of cleaning before and after each use can affect the correct operation of the machine.

⚠ Danger of burning! Dispensing may be preceded by small jets of hot water.

After each milk dispensing, the display shows the following screen for a few seconds.

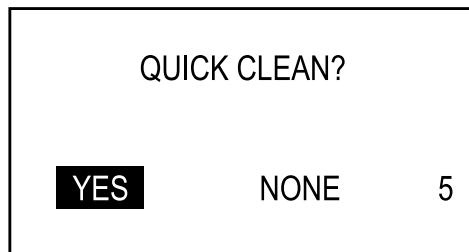

Proceed as follows to perform the rinse cycle: Select "YES" and press the "OK" button. The following screen is displayed:

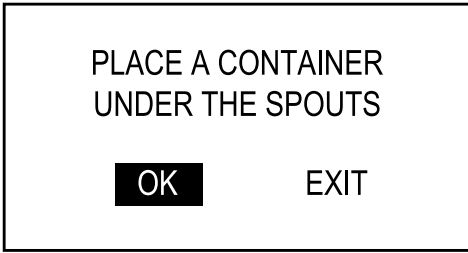

Place a container under the Cappuccinatore spout.

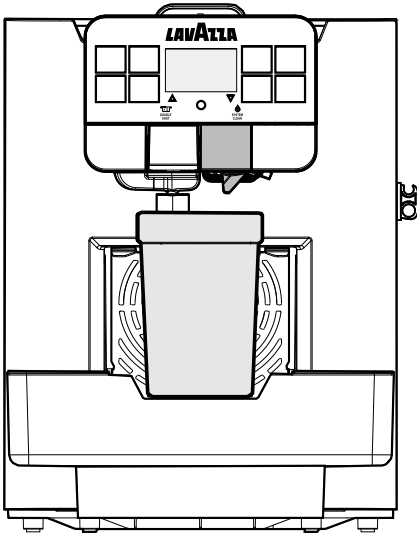

Select "OK" and press the "OK" button. The machine dispenses a quantity of water sufficient to rinse the milk circuit. The following screens appear:

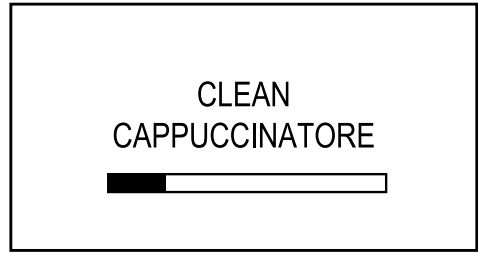
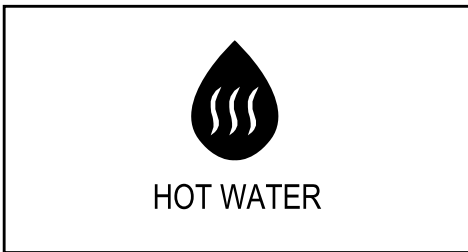

Remove the container.

If you do not want to perform the rinse cycle, select "NO" using the arrow key. Press the "OK" button.

After a certain time, this rinse request screen automatically disappears and the machine goes back to the ready for use mode.

 Always remember to store milk in the fridge when not used.

This function allows the machine to preserve proper hygiene and operating conditions. However, this should not be considered sufficient to clean the milk circuit.

The Cappuccinatore light cleaning cycle can be performed any time by following the procedure below:

With the machine on, press the "OK" button. Access the user menu and scroll it until the "Clean Cappuccinatore" option. Then, press the "OK" button again. To speed up this procedure, you just need to press the "Down"/"System Clean" button.

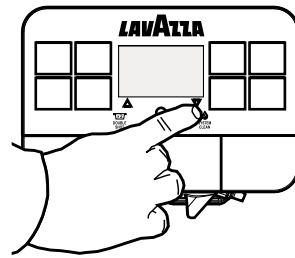

Select the "CAPPUCCINATORE LIGHT CLEAN" option and confirm with the "OK" button.

CAPPUCCINATORE
LIGHT CLEAN

The cleaning cycle starts. The following screen is displayed:

PLACE A CONTAINER
UNDER THE SPOUTS

OK

EXIT

Place a container under the Cappuccinatore spout.

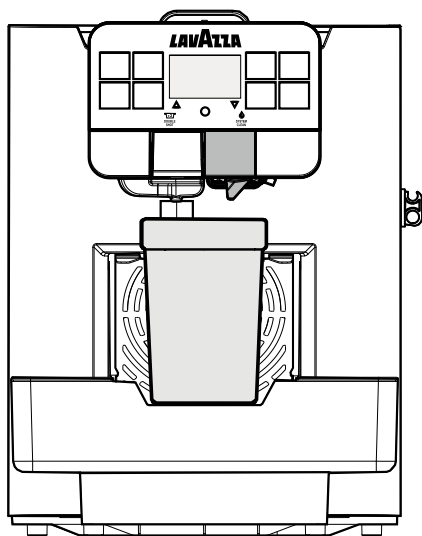

Select "OK" and press the "OK" button. The machine dispenses a quantity of water sufficient to rinse the milk circuit. The following screens appear:



HOT WATER

CLEAN
CAPPUCCINATORE

In this case, the cleaning cycle is performed with hot water only and the suction hose is not used. At the end of the cleaning cycle, this must be washed under running water. Wait until the cycle stops automatically. The machine will go back to the ready for use state.

10.2.7 Thorough Cleaning of the Cappuccinatore

Clean all the Cappuccinatore parts thoroughly every day by using a specific detergent available on the market.

The lack of cleaning before and after each use can affect the correct operation of the machine.

With the machine on, press the "OK" button. Access the user menu and scroll it until the "Clean Cappuccinatore" option. Then, press the "OK" button again. To speed up this procedure, you just need to press the "Down"/"System Clean" button.

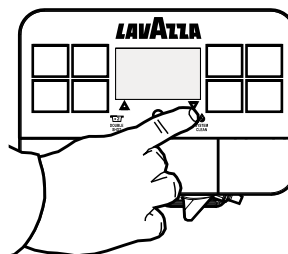

Select the "CAPPUCCINATORE COMPLETE CLEAN" option and confirm with the "OK" button.

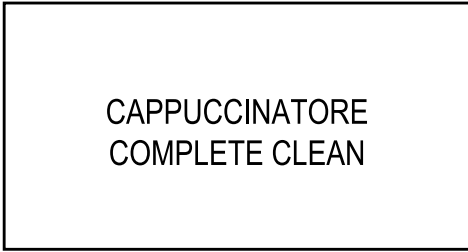

After a warming-up phase, if necessary, the cleaning cycle starts automatically and the following screens show in sequence:

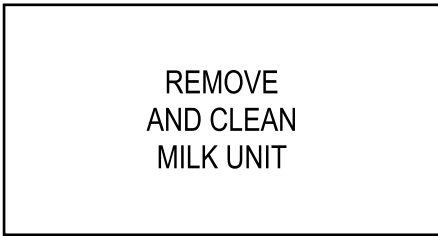

Lower coffee spout.

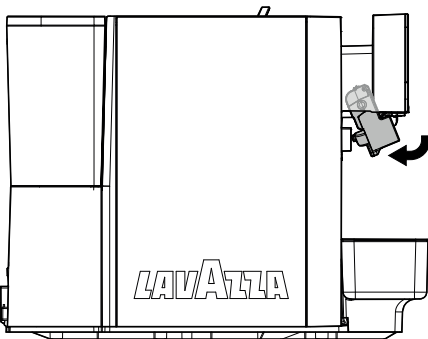
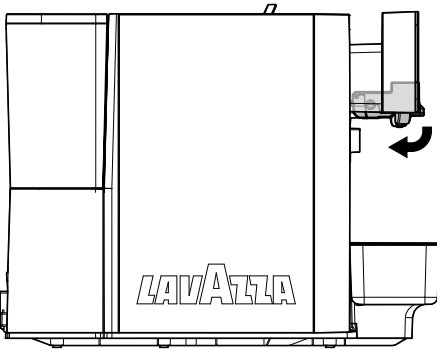

Remove the Cappuccinatore cover from the machine.

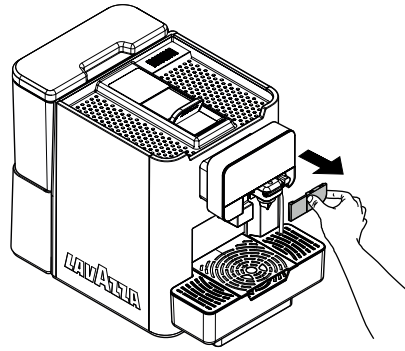

Press the button on the left side and remove the Cappuccinatore.

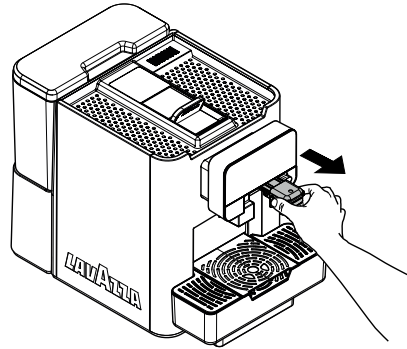

The following screen is displayed:

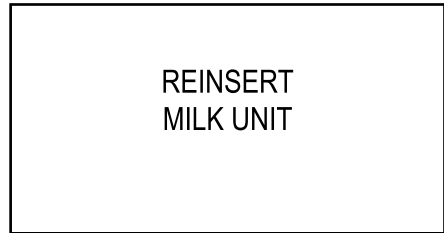

Disassemble and clean the Cappuccinatore as indicated below.

Remove the suction tube from the Cappuccinatore.

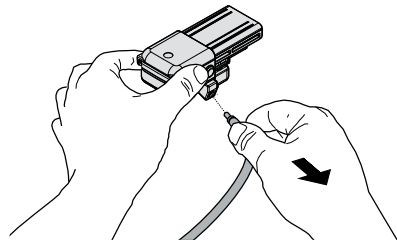

Remove fitting from milk suction hose.

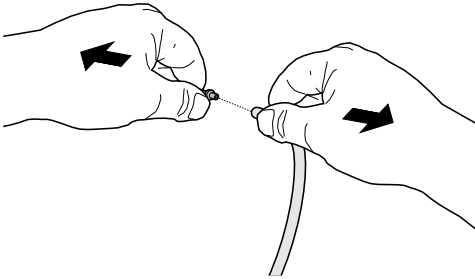

Clean the fitting with the brush as indicated in the figure.

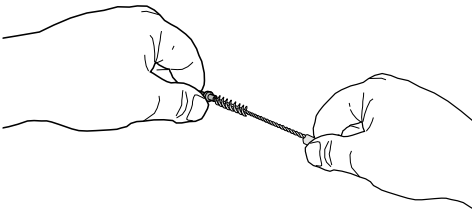

Clean the milk suction hose inside with the scraper, as in the figure.

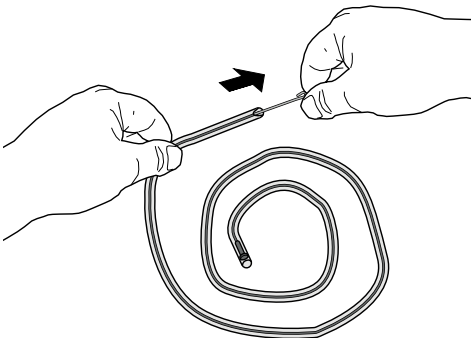
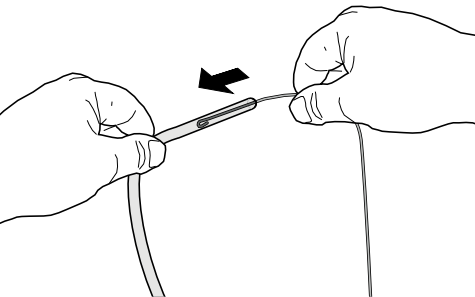

Remove the ring from the Cappuccinatore.

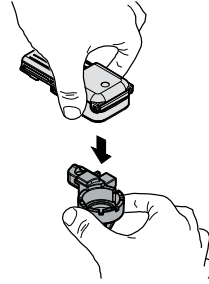

Rotate the Cappuccinatore cover and remove it from the Cappuccinatore body.

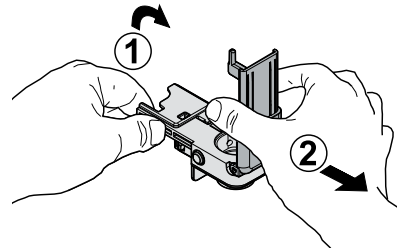

Remove the valve from the Cappuccinatore.

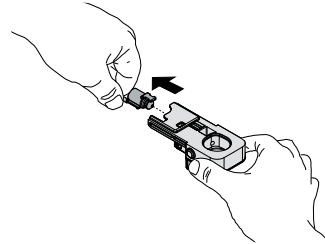

Wash the parts under running water. Remove any milk deposits/crusts using the brush as indicated in the figure.

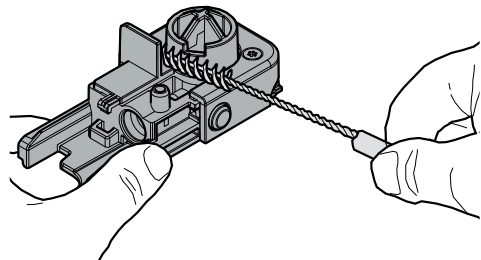

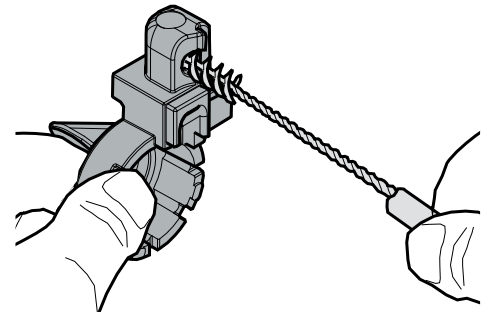
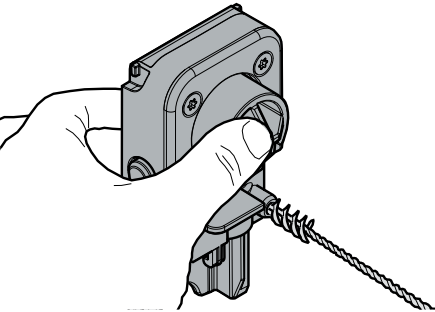
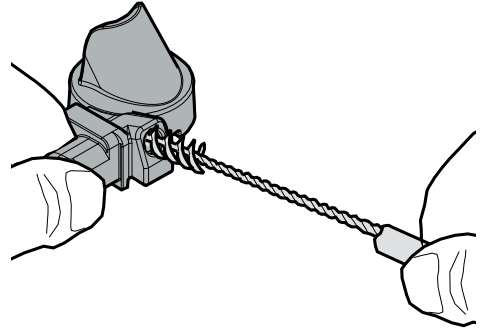
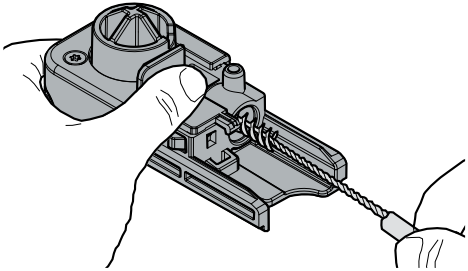
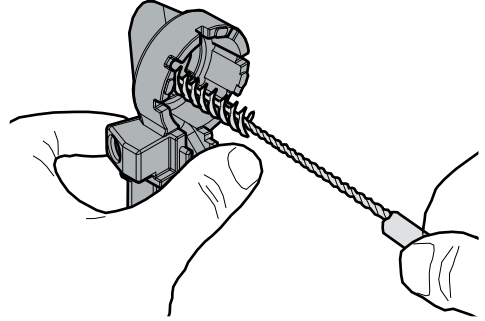
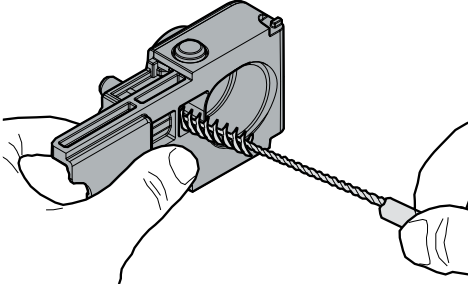
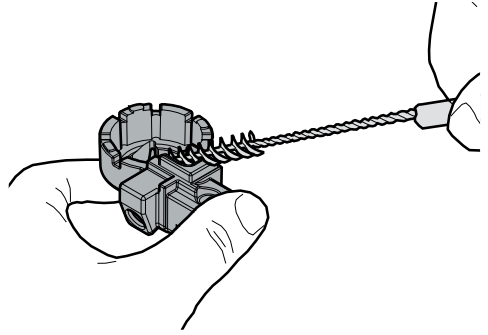
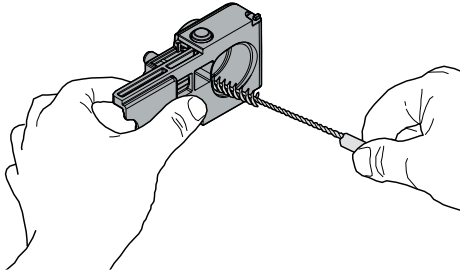

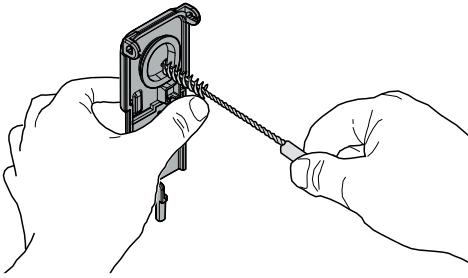

After washing, reassemble the parts following the same procedure used for disassembly, but in reverse order.

⚠ Take particular care in reassembling the ring on the Cappuccinatore, pushing the area of the suction hose/milk outlet connector, as shown in the figure.

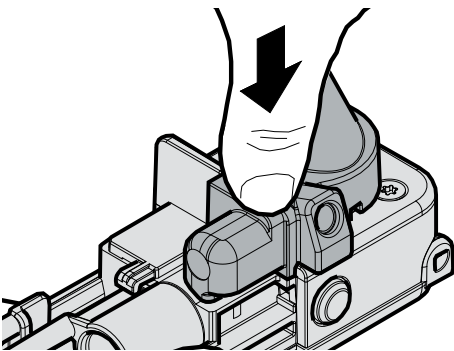

👉 After washing and reassembling the Cappuccinatore, it can be installed back in the machine.

⚠ Once they have been properly disassembled, the milk Cappuccinatore components can be washed in the dishwasher maximum once a week at a temperature not exceeding 70°C / 158°F.

The following screen is displayed:



⚠ Danger of burning! Dispensing may be preceded by small jets of hot water.

Place a 10 oz container under the hot water dispensing spout.

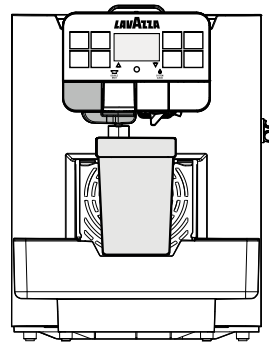

Select "OK" and press the "OK" button. The following screen is displayed:

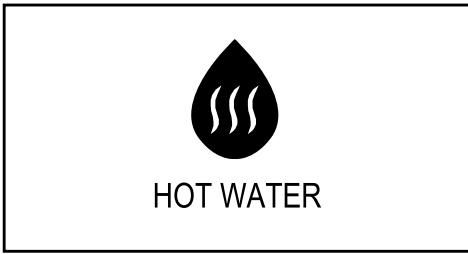

The machine dispenses 10 oz of hot water. Once dispensing ends, the screen below appears:

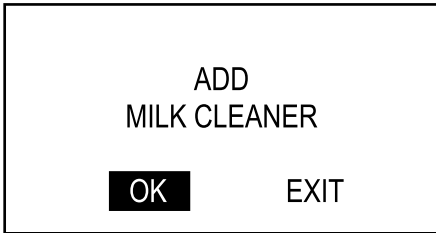

Pour the contents of a detergent bag into the hot water container. Wait for the contents of the bag to dissolve completely.

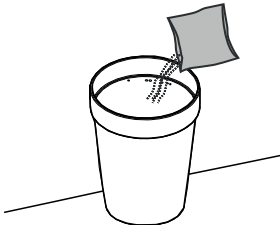

Select "OK" and press the "OK" button. The following screen is displayed:

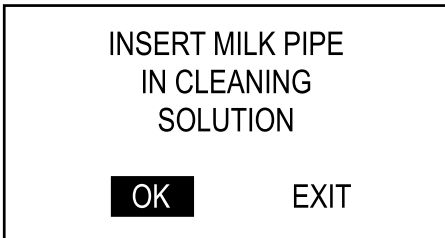

Insert the clean tube directly into the container.

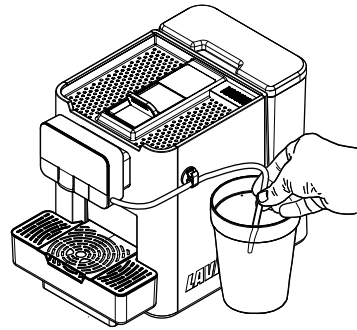

Place another container under the Cappuccinatore spout.

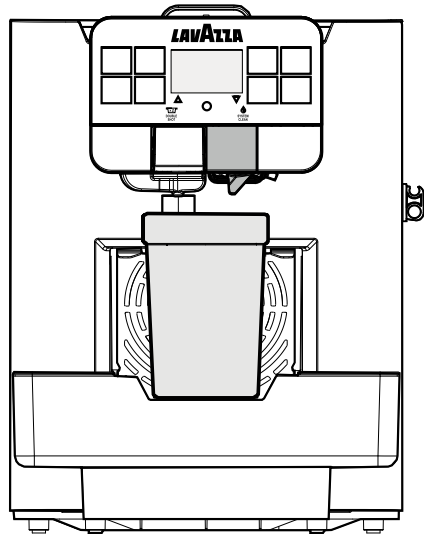

Select "OK" and press the "OK" button. The following screen is displayed:

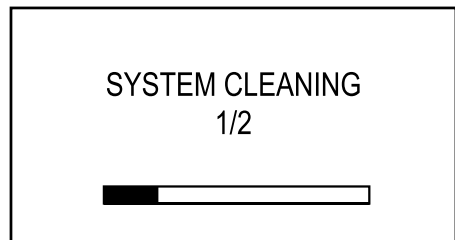

The Cappuccinatore thorough cleaning cycle first phase starts. Wait until the cycle stops automatically. The following screen is displayed:



Empty the container under the Cappuccinatore spout.

Rinse the container where the Cappuccinatore tube was inserted and place it under the hot water dispensing spout.

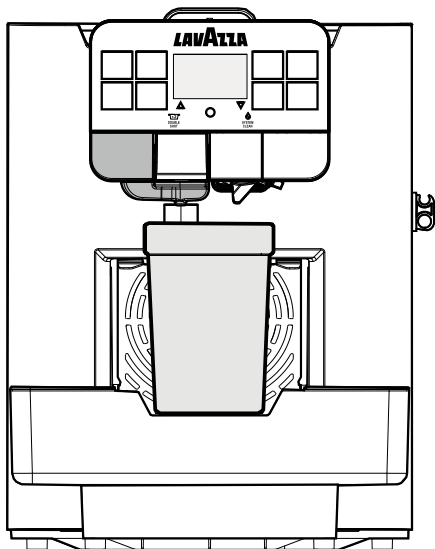

Select "OK" and press the "OK" button. The following screen is displayed:

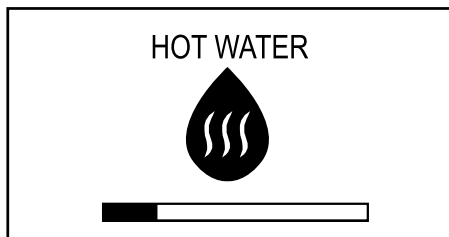

The machine dispenses 10 oz of hot water. Once dispensing ends, the screen below appears:

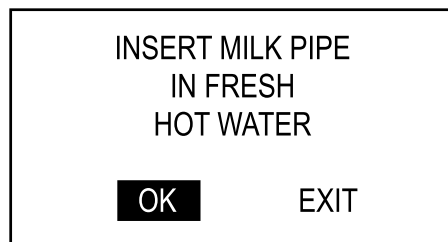

Insert the clean tube directly into the container.

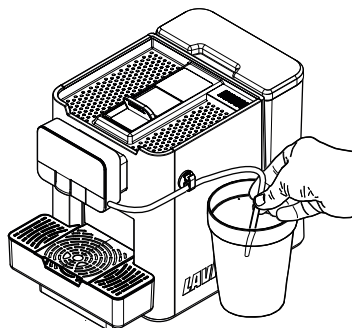

Place another container under the Cappuccinatore spout.

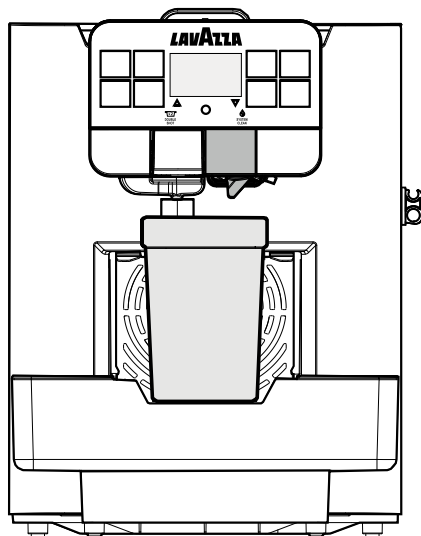

Select "OK" and press the "OK" button. The following screen is displayed:

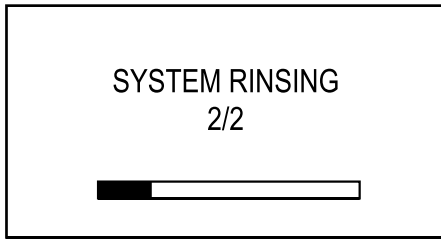

The Cappuccinatore thorough cleaning cycle second phase starts. Wait until the cycle stops automatically. The following screen is displayed:



 If the following screen appears during the Cappuccinatore thorough cleaning cycle, restart the cleaning cycle.

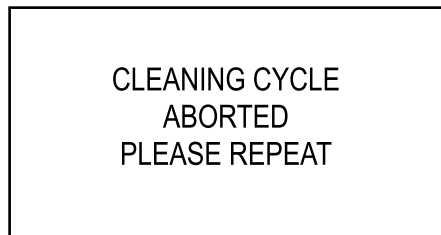

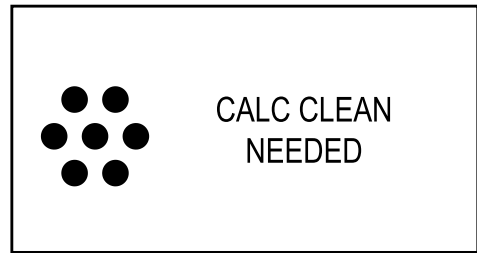

10.2.8 DESCALING

Limescale is a natural part of the water used for machine operation. It needs to be removed regularly as it may clog the water and coffee circuit of your appliance. The advanced electronics show when descaling is required on the machine display.





Just follow the steps described below. This operation needs to be carried out before the appliance stops working properly, as in this case repair is not covered by warranty. The descaling solution and the complete "Maintenance Kit" may be purchased at your local dealer or at authorised service centres.

 Do not drink the decalcifying solution.

 Never use vinegar as a descaling solution.

Turn on the machine by pressing the ON/OFF button. Wait for the machine to complete the rinse and warm-up process.

 Make sure that the Cappuccinatore is inserted, remove the suction hose from the Cappuccinatore.

 Remove the anti-scale filter before adding the descaling solution.

Switch to machine programming mode as described in the "Access to the Maintenance Menu" section. Scroll the menu until the "Descaling Cycle" option.

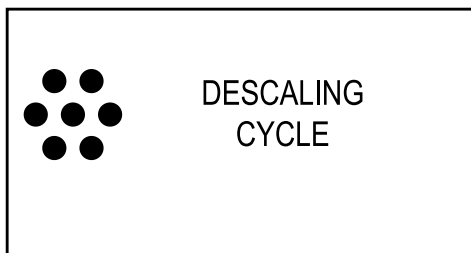

Press the "OK" button. The following screen is displayed:



Remove the tank from the machine and empty it.

Remove the anti-scale filter.

Select "OK" and press the "OK" button. The following screen is displayed:



Remove and empty the drip tray.

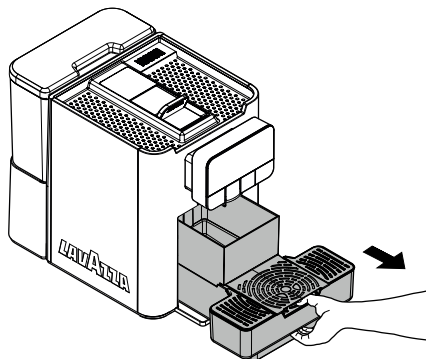

After emptying it, put the drip tray back into place. Select "OK" and press the "OK" button. The following screen is displayed:

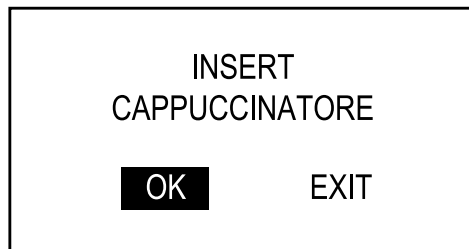

Check that the Cappuccinatore is correctly positioned. Press the "OK" button. The following screen is displayed:

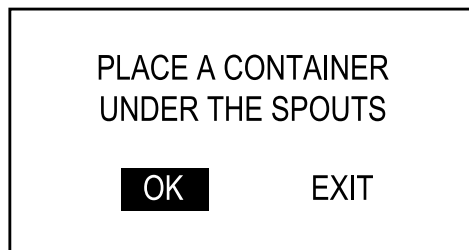

Place a large container under the dispensing spouts (hot water, coffee and cappuccino).

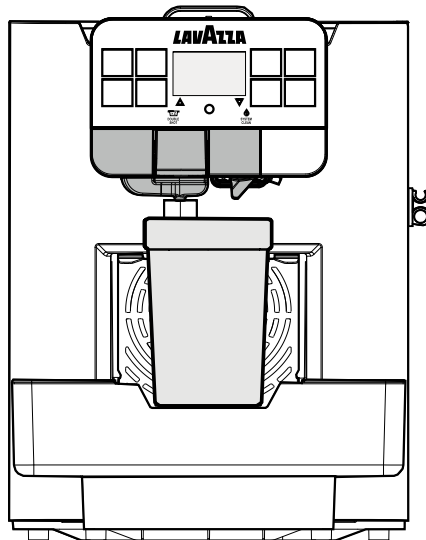

Select "OK" and press the "OK" button. The following screen is displayed:

POUR DESCALER
AND WATER INTO
WATER TANK

OK

EXIT

Pour 250 ml / 8 oz descaler and 750 ml / 25 oz water into the water tank. Select "OK" and press the "OK" button. The following screen is displayed:

DESCALING
PHASE 1/2

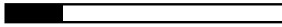

PAUSE

The first descaling phase starts. Press the "OK" button to pause the cycle. Press the "OK" button again to resume the cycle. When the solution in the tank is finished, the machine requests to empty and rinse the tank with fresh drinking water.

RINSE WATER TANK
AND FILL WITH
FRESH WATER

OK

Rinse the water tank thoroughly and fill it with fresh drinking water up to the MAX level. Press the "OK" button. The following screen is displayed:

EMPTY
DRIP TRAY

OK

Remove and empty the drip tray. After emptying it, put the drip tray back into place. Press the "OK" button. The following screen is displayed:

INSERT
CAPPUCCINATORE

OK

Check that the Cappuccinatore is correctly positioned. Press the "OK" button. The following screen is displayed:

PLACE A CONTAINER
UNDER THE SPOUTS

OK

Place a large container under the dispensing spouts (hot water, coffee and cappuccino). Press the "OK" button. The following screen is displayed:

DESCALING
PHASE 2/2

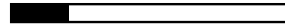

PAUSE

Press the "OK" button to pause the cycle. Press the "OK" button again to resume the cycle. Once the cycle ends, the screen below appears:



DESCALING COMPLETED









Re-fit the small white filter. Fill the water tank again up to the MAX level with fresh drinking water.

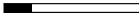

After performing the descaling cycle, rinse the Cappuccinatore under running water. Empty the containers used to collect the liquids during descaling. The descaling solution must be disposed of according to the manufacturer's instructions and/or regulations in force in the country of use. Empty the drip tray and put it back into place.



II TROUBLESHOOTING

II.1 Warning signals

This chapter describes all the warning messages that the machine may display to the user and the actions that can and/or must be performed by the user.

Warning Signals	How to reset the message
<p>SYSTEM BOOT</p> 	The machine is switching on.
<p>PRESS A BUTTON</p>	Machine in Stand-by. Press a button.
<p>POWER ON CLEANING</p> 	Upon power-on, the machine activates a cleaning cycle.
 <p>HEATING UP</p> 	The machine is warming up to brew beverages or dispense hot water.
 <p>RINSING</p> 	The machine is rinsing. Wait until the machine has completed the cycle.
<p>CHOOSE BEVERAGE</p> <p>0%</p> 	The machine requires water filter replacement.
 <p>PRIMING</p> 	The machine is priming the circuit.
	The machine is out of credits. To brew products, contact the service provider to restore the credits.

Warning Signals	How to reset the message
<p>CHOOSE BEVERAGE</p> 	<p>The machine reminds you that it will be necessary to perform a descaling cycle in a few cycles.</p>
<p>CALC CLEAN NEEDED</p> 	<p>The machine requires a descaling cycle. When this message is displayed, it is still possible to use the machine, but its correct operation might be affected. Damage caused by failure to descale the machine is not covered by warranty. Upon machine power-on, a warning message is displayed for 5 seconds. The descaling cycle can be performed through the maintenance menu only.</p>
<p>CHOOSE BEVERAGE</p> <p>5</p> 	<p>The machine reminds you that it will be necessary to empty the capsule drawer in a few cycles (see the "Emptying the capsule drawer and the drip tray" section). The machine still allows you to dispense products.</p>

Alarm warnings	How to reset the message
<p>INSERT DRAWER</p>	<p>Insert the drip tray and the capsule drawer into the machine.</p>
	
<p>EMPTY CAPSULES DRAWER</p>	<p>Empty the capsule drawer.</p>
	
 <p>ADD WATER</p>	<p>Fill the water tank.</p>
<p>CLOSE SLIDING DOOR</p>	<p>The machine requires you to close the capsule tray.</p>
<p>INSERT CAPPUCCINATORE</p> <p>XX</p>	<p>The selected operation requires milk dispensing. Ensure that the Cappuccinatore is correctly and fully assembled. Insert the Cappuccinatore in the machine as specified in the manual.</p>

Alarm warnings	How to reset the message
 3 SUPPORT REQUIRED	<p>Turn off the machine. Turn it back on after 30 sec. Try this 2 or 3 times. If this warning appears again, contact the service provider and indicate the code shown in the display.</p>

11.2 Problems - Causes - Solutions

The following table indicates the possible error or alarm causes which may lead to a partial or total shutdown of the appliance.

Error code	Description
E3	Error 3: COD_BU_CANT_REACH_WORK_FAILURE Indicates that the brew unit could not be set to the Work position for capsule closing
E4	Error 4: COD_BU_CANT_REACH_HOME_FAILURE Indicates that the brew unit could not be released from the Work position
E5	Error 5: COD_WATER_CIRCUIT_FAILURE Indicates a fault regarding the water circuit for hot water/coffee: the pump has completed the three circuit priming attempts
E6	Error 6: COD_EV_DRV_FAILURE Indicates that one or more solenoid valves are in short-circuit and therefore they cannot be used
E8	Error 8: COD_STEAM_CIRCUIT_FAILURE Indicates a fault regarding the Steam water circuit: the pump has completed the three circuit priming attempts
E10	Error 10: COD_NTC_C_SHORT_FAILURE Indicates that the coffee boiler NTC temperature sensor is in short-circuit
E11	Error 11: COD_NTC_C_OPEN_FAILURE Indicates that the coffee boiler NTC temperature sensor is not connected
E12	Error 12: COD_NTC_S_OPEN_FAILURE Indicates that the steam boiler NTC temperature sensor is not connected
E13	Error 13: COD_NTC_S_SHORT_FAILURE Indicates that the steam boiler NTC temperature sensor is in short-circuit
E14	Error 14: COD_HC_TIMEOUT_FAIL Indicates that the coffee boiler supply is not connected
E15	Error 15: COD_HS_TIMEOUT_FAIL Indicates that the steam boiler supply is not connected
E19	Error 19: COD_Z_CROSSING_FAILURE
E20	Error 20: COD_HC_OVER_TEMP_FAILURE Indicates that the coffee boiler is overheated
E21	Error 21: COD_HS_OVER_TEMP_FAILURE Indicates that the steam boiler is overheated

12 STORAGE - DISPOSAL

12.1 Location Change

Should the machine be placed in a different location, it is necessary to:

- disconnect the appliance from the supply network;
- carry out the general cleaning of the appliance as indicated in chapter "Cleaning and Maintenance";
- put the parts back into place and close the doors;
- Lift and position the appliance in the assigned location.

12.2 Inactivity and Storage

If the appliance needs to be stored or remains inactive for a long period, carry out the same operations as described in section "Location Change", therefore:

- wrap the appliance with a cloth to protect it from dust and humidity;
- Check that the appliance is in a suitable area. The temperature must not be less than 1°C / 33.8°F. Take care not to place boxes or equipment on it.

13

INSTRUCTIONS FOR END OF OPERATIONAL LIFE DISPOSAL**INFORMATION FOR THE USER**

in compliance with art. 13 of the Italian Legislative Decree dated 25 July 2005, no. 151 "Implementation of the directives 2002/95/EC, 2002/96/EC and 2003/108/EC on the restriction of the use of certain hazardous substances in electrical and electronic equipment, as well as waste disposal".

The crossed-out wheeled bin icon on the appliance or its packaging indicates that the product must be disposed of separately from other waste at the end of its operational life.

Separate collection of the appliance, once at the end of its operational life, is organised and managed by the manufacturer. Therefore, for an appropriate disposal, the user must contact the manufacturer and observe its separate collection management adopted for this appliance at the end of its operational life.

Separating this product for subsequent recycling, treatment and environmentally-friendly disposal will help prevent potential environmental and health risks, and allow the materials which make up the appliance to be re-used and/or recycled.

Specific administrative sanctions provided for by current regulations will be applied for illicit disposal of the product by the user.

