

Operations & Parts Manual



www.cantekamerica.com



JDT65

Manual Dovetailer

Please ensure you have your serial number available when contacting us for parts or service.

Cantek America Inc. | 1.888.982.2683 | **Parts:** sales@cantekamerica.com | **Service:** service@cantekamerica.com

Features

- Ideal for drawer production and furniture parts which require high quality dovetail joints.
- Tenon and mortise depth are conveniently adjusted according to the thickness of work piece.
- Equipped with one four-sided template providing four types of pitches between dovetails.

SPECIFICATIONS

Model	JDT-65	JDT-65S
Minimum work piece size	200 x 60 mm	
Maximum work piece size	1500 x 420 mm	
Minimum dovetail height	5 mm	
Maximum dovetail height	18 mm	
Minimum front thickness	7 mm	
Maximum front thickness	60 mm	
Minimum side thickness	7 mm	
Maximum side thickness	60 mm	
Number of spindles	1	
Motor	1HP (1PH)	
Spindle speed (RPM)	18500 RPM	
Center-to-center dovetail spacing	1", 1-1/2", 2", 2-1/2 "	
	5/8", 3/4", 1-1/4", 1-3/4"(Optional)	
	25, 40, 50, 80 mm (Optional)	
	16, 18, 32, 36 mm (Optional)	
Table height from floor	1180 mm	
Dust collection ports diameter	front 2-1/2", rear 4"	
Packing dimensions	105 x 79 x 160 cm	
N.W. / G.W.	200 / 245 Kgs	150 / 195 Kgs

*All specification, dimensions and design characteristics are subject to change without prior notice.

IMPORTANT : When ordering replacement parts, always give the model number, serial number of the machine and part number. Also a brief description of each item and quantity desired.

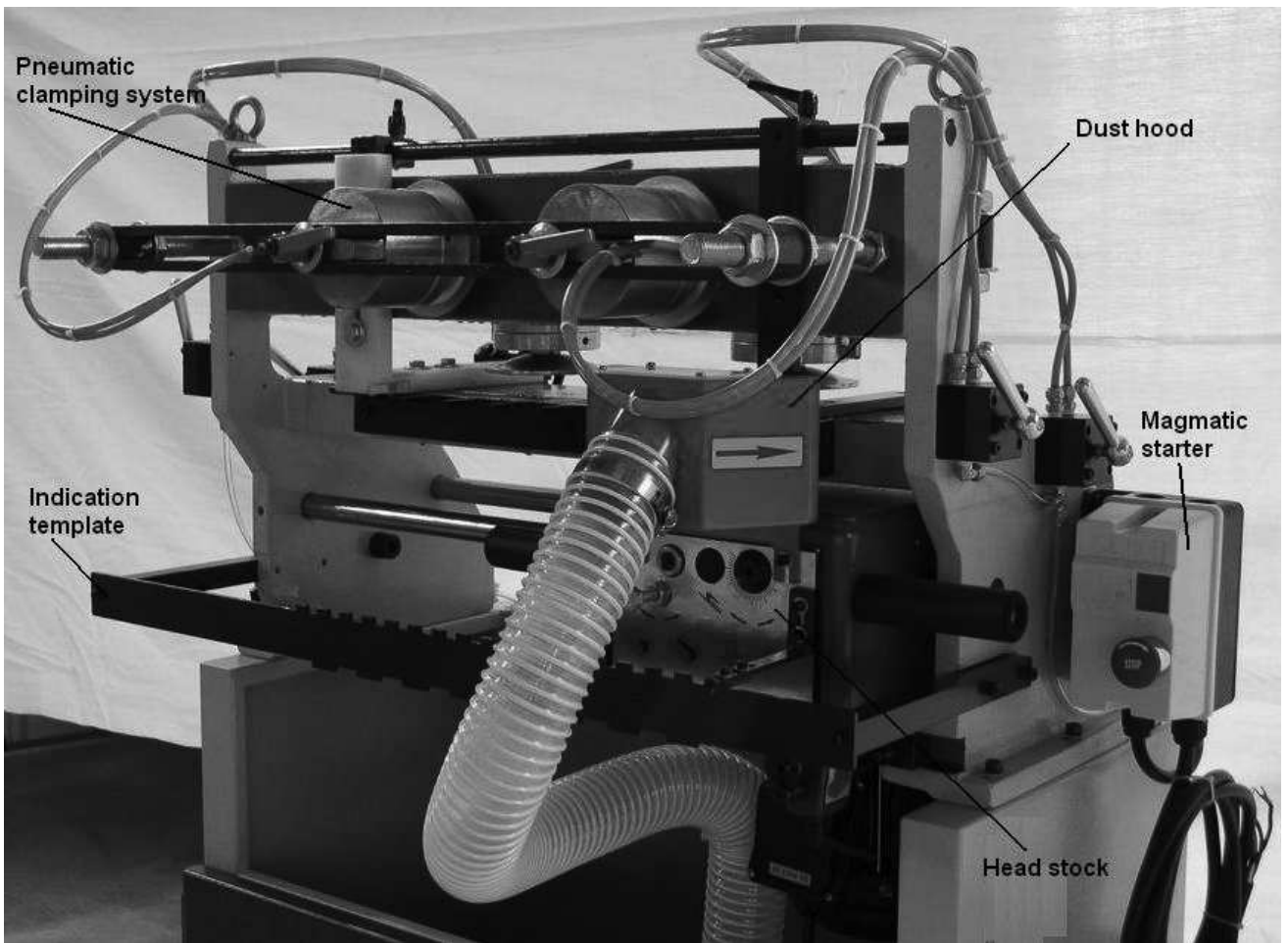

1. Indication Template
2. Open-end Wrench 30mm
3. Hex Wrenches
4. Combination Wrenches (17-19, 12-14, 11-13, 8-10)
5. Fence
6. Fixed Chasers
7. Grease Gun

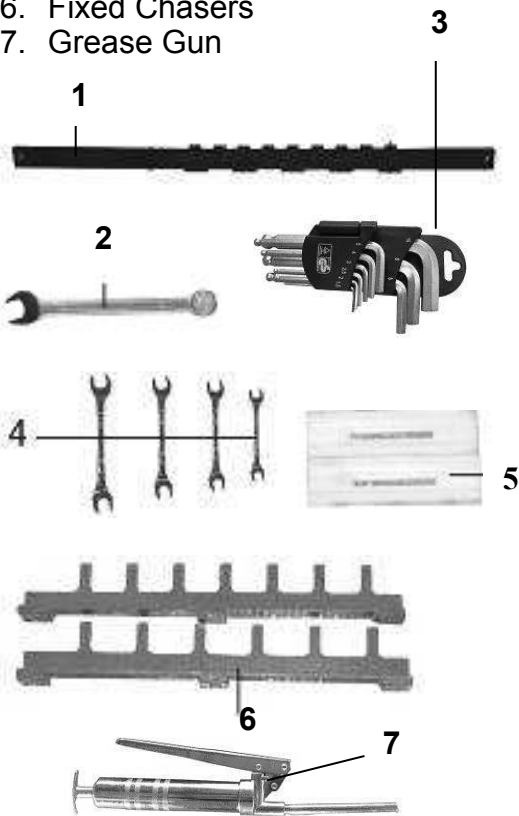

Terminology

Below are the terms used in this manual to identify types of cuts and measurements.

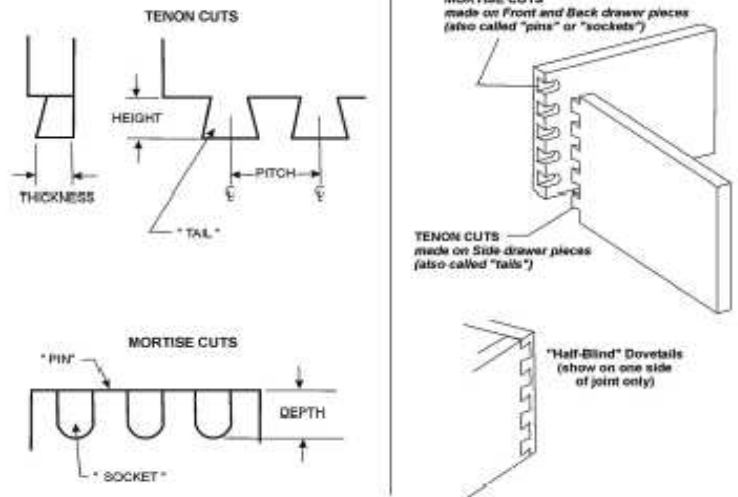

Installation & Assembly

Tools required for assembly

forklift or hoist with straps/slings

14mm wrench (provided)

[NOTE: A socket set with ratchet wrench may speed assembly]

1. Remove the four screws and flat washers holding the machine to the pallet with a 14mm wrench, as shown in Figure 1.
2. Place lifting straps through the two eyebolts at the top of the machine (B, Figure 2). Using a forklift or hoist, lift the machine off the pallet and into its desired location. The Dovetailer should be located in a dry area with sufficient lighting. Leave plenty of space around the machine for operations and routine maintenance work.
3. If desired, the Dovetailer can be further stabilized by securing it to the floor, using lag screws through the four holes at the bottom of the cabinet.
4. A group of cords holds the headstock secure to the machine frame to prevent it from moving during shipping. These cords should now be cut and removed (see Figure 3).
5. Exposed metal areas of the dovetailer (such as the table, template bar, cylinder clamps, rods, etc.) have been factory coated with a protectant. This should be removed with a soft cloth dampened with kerosene or mineral spirits. Do not use an abrasive pad. Do not let solvent contact plastic or rubber parts as it may damage them.

Attaching Dust Hose

1. Slide the upper end of the hose over the chute on the dust hood (Figure 4).
2. Tighten the hose clamp with the attached screw, using a flat head screwdriver.

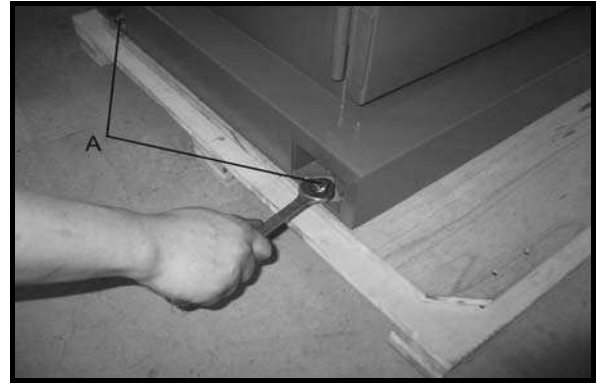

Figure 1

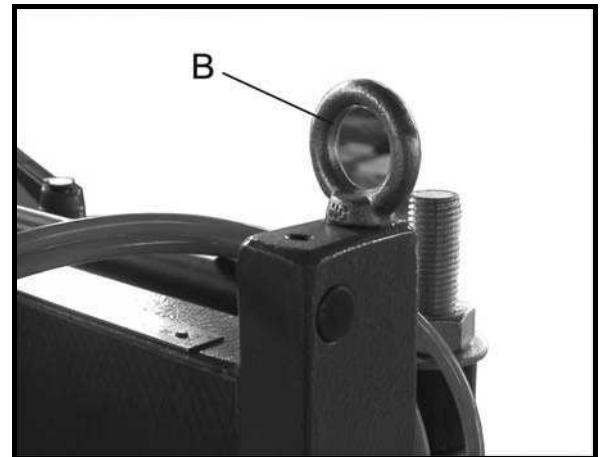

Figure 2



Figure 3

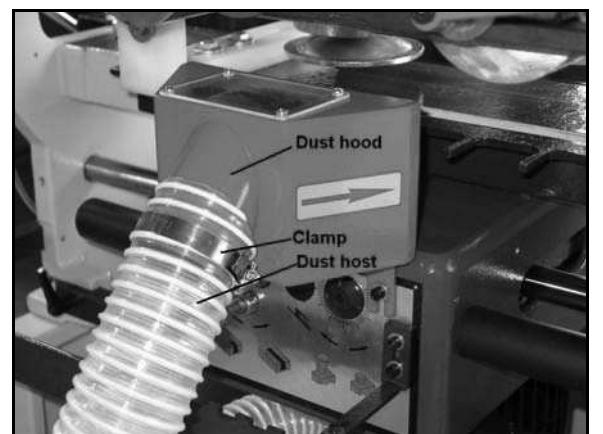

Figure 4

Installing Dust Chute

Remove the four socket head cap screws at the rear of the cabinet, using a 4mm hex wrench. Place the 4" diameter dust chute (Figure 5) over the hole, and re-insert and tighten the four socket head cap screws.

Dust Collection

The use of a dust collection system is strongly recommended for this machine. It will help you're your shop clean as well as minimize any health risks caused by wood dust. Make sure your dust collector has a capacity of at least 500 cubic feet per minute (CFM). Connect the intake hose of your dust collector to the 4" diameter dust chute at the back of the cabinet (Figure 5).

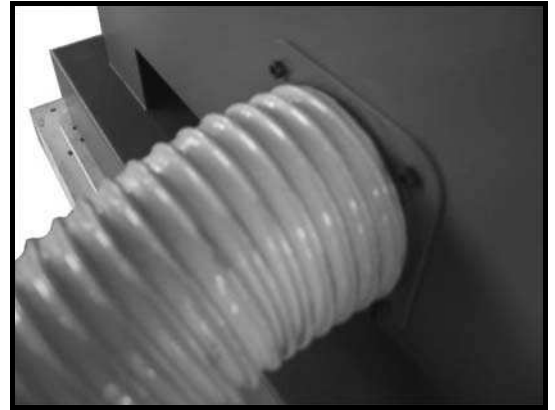

Figure 5

Grounding Instructions

⚠ WARNING Electrical connections must be made by a qualified electrician in compliance with all relevant codes. This machine must be properly grounded to help prevent electrical shock and possible fatal injury.

This machine must be grounded. In the event of a malfunction or breakdown, grounding provides a path of least resistance for electric current to reduce the risk of electric shock.

Improper connection of the equipment grounding conductor can result in a risk of electric shock. The conductor, with insulation having an outer surface that is green with or without yellow stripes, is the equipment grounding conductor. If repair or replacement of the electric cord or plug is necessary, do not connect the equipment-grounding conductor to a live terminal.

Check with a qualified electrician or service personnel if the grounding instructions are not completely understood, or if in doubt as to whether the tool is properly grounded. Use only three wire extension cords that have three-prong grounding plugs and three-pole receptacles that accept the tool's plug.

Repair or replace a damaged or worn cord immediately. Make sure the voltage of your power supply matches the specifications on the motor plate of the Dovetailer.

230 Volt Operation

As received from the factory, the JDT-65 Dovetailer is designed to run on 230 volt power only. You may either connect a UL/CSA listed 230V plug (similar to the one shown in Figure 6) or “Hard-wire” the machine directly to a control panel. If hard-wired to a panel, make sure disconnect is available for the operator. The dovetailer must comply with all local and national codes after being wired.

1. If it is to be hard-wired, make sure the fuses have been removed or the breakers have been tripped in the circuit to which the dovetailer will be connected. Place a warning placard on the fuse holder or circuit breaker to prevent it being turned on while the machine is being wired.
2. Refer to “Electrical Connections” for connecting the motor leads.
3. The Dovetailer with a 230 volt plug should only be connected to an outlet having the same configuration. No adapter is available or should be used with the 230 volt plug.

Air Connection

Connect the air supply hose to the coupling on the air unit (Figure 7).

⚠ WARNING Even after the air has been turned off to the machine, there may be residual air inside the lines, and the clamping cylinders can still provide a hazard to fingers. After shutting off the air, always bleed residual air from the system by pushing the relief valve pin at the bottom of the air cup, shown in Figure 7. Keep the relief valve open until all air in the system has been removed.

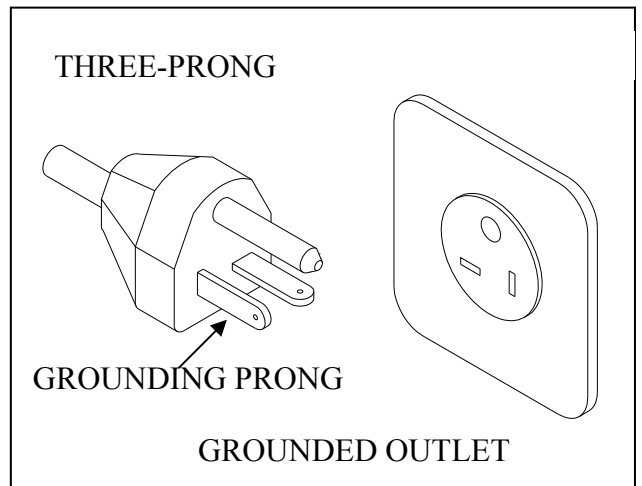

Figure 6



Figure 7

Adjustments

⚠ WARNING Disconnect machine from power source, shut off air supply and bleed residual air from system, before making adjustments. Failure to comply may cause serious injury.

Clamping Cylinders

The workpieces are clamped to the table by pneumatically operated aluminum cylinders (A, Figure 8). Each cylinder has its own air on/off lever (B, Figure 8) to “on” position to activate the cylinder; the cylinder will respond immediately by clamping the workpiece against the table.

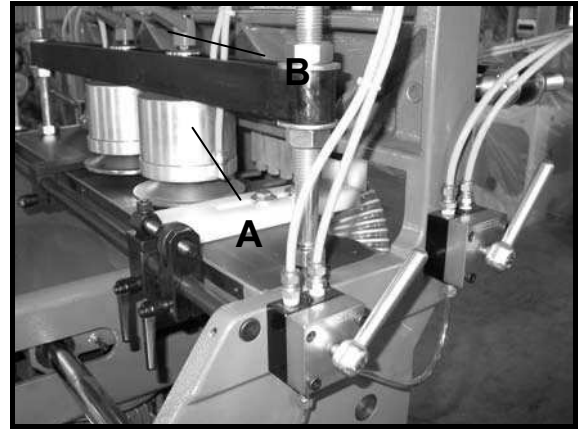

Figure 8

⚠ WARNING Always keep fingers out of the way of clamping cylinders. Failure to comply may cause serious injury.

Both vertical and horizontal clamping cylinders can be adjusted to match the thickness of your workpieces. To change the thickness capacity of the clamping cylinders, proceed as follows:

1. To increase the clamping capacity, loosen the top two hex nuts (A and B, Figure 9) on the stud at the end of the holder bracket, with a 30mm wrench. Do the same for the stud at the opposite end of the holder bracket.
2. Tighten the lower hex nut (C, Figure 9). You can do this without a wrench. This will raise the holder bracket. Do this incrementally on both studs until the desired height is reached. When finished, tighten top hex nuts (A & B, Figure 9) on both studs with the wrench.

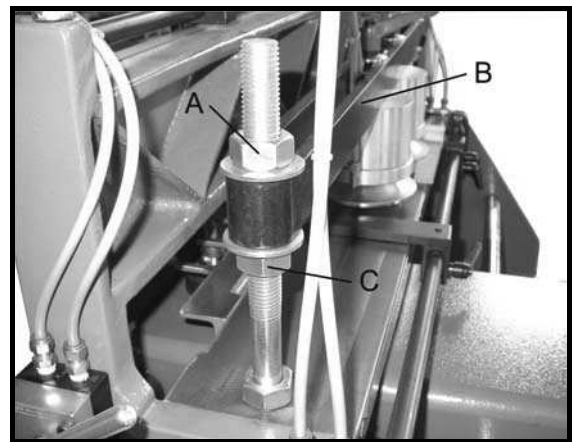

Figure 9

NOTE: Make equal adjustment on both studs at each end of the holder bracket to ensure the clamps are parallel to the table. To check this, measure from the bottom edge of the holder bracket down to the table. Measure at each end of the holder bracket – the measurements should be equal. Figure 9 shows the horizontal clamping assembly - the procedure is identical for the vertical clamping assembly.

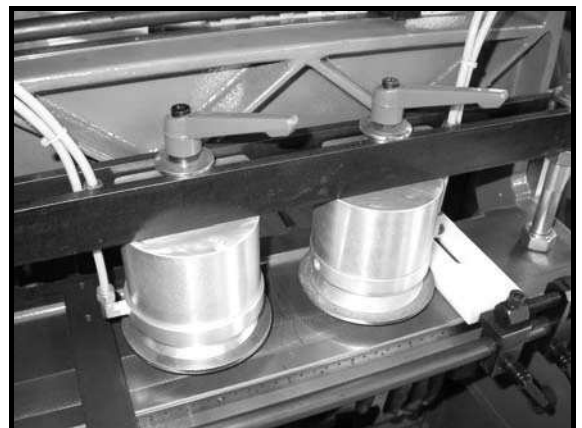

Figure 10

3. To decrease the clamping capacity, back off the lower hex nut (C, Figure 9) and tighten the top hex nut (A, Figure 9). This will lower the holder bracket.
4. When finished, tighten the lower hex nut (C) against the holder bracket, and bring hex nut (A) down against hex nut (A).

The clamping cylinders can also be adjusted laterally for better support of workpieces with differing widths. Simply loosen the locking handle (Figure 10) and slide the clamping cylinder to position. Re-tighten locking handle.

Clamping Pressure

The pressure exerted by the cylinder clamps against the workpiece can be adjusted at the air regulator, shown in Figure 11. The hardness or softness of the wood will determine the amount of clamping pressure desired. Enough pressure should be used to prevent the workpiece from slipping during operations. Forty (40) psi is suitable for clamping most wood; going above that is not recommended.

To change the clamping pressure, pull up on the knob (A, Figure 11) and rotate it; clockwise to increase pressure, counterclockwise to decrease pressure. The attached needle indicator (B, Figure 11) shows the air pressure. Lock the setting by pushing the knob (A, Figure 11) back down.

Locking Handles

All locking handles, such as those shown in Figure 10, can be rotated out of the way if they interfere with other machine parts. Simply lift straight out on the locking handle and rotate it, then release, making sure it seats properly.

Template Bar

The four-sided template bar, shown in Figure 14, will allow you to create “half-blind” dovetails, where the dovetails are visible on only one side of the joint. It will create dovetails in one of four different “itches” or centerlines. The available pitches are 1”, 1-1/2”, 2” and 2-1/2”. To change the pitch of a dovetail cut, proceed as follows:

1. First notice how the notches on the template bar are grouped toward the right side of the machine. The template bar should always be oriented in this fashion.
2. Release one end of the spring on the left side of the headstock (Figure 12) and pull the headstock forward until the tracer pin (Figure 13) is clear of the template bar.
3. Loosen and remove the locking handles on each end of the template bar (Figure 14).
4. Pull out the template bar, flip it to the desired side, and then reinstall it.

NOTE: The pitch dimension is inscribed on each side of the template bar. The side of the template bar that you have chosen should face downward when mounted on the machine.

5. Insert and tighten both locking handles.



Figure 11

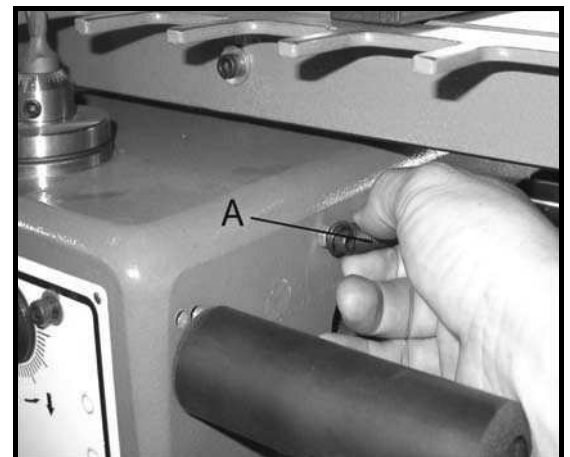

Figure 12



Figure 13

6. Push the headstock back and re-connect the spring (Figure 12).
 You must now also shift the indication template (Figure 14). See "Indication Template."

Indication Template

Because the tracer pin is not easily observed while the machine is in operation, the indication template (A, Figure 15) provides the operator with a visual record of the progress of the "hidden" tracer pin. The bracket (B, Figure 15) slides in and out of the notches on the indication template, echoing the tracer pin as it slides in and out of the notches on the template bar below.

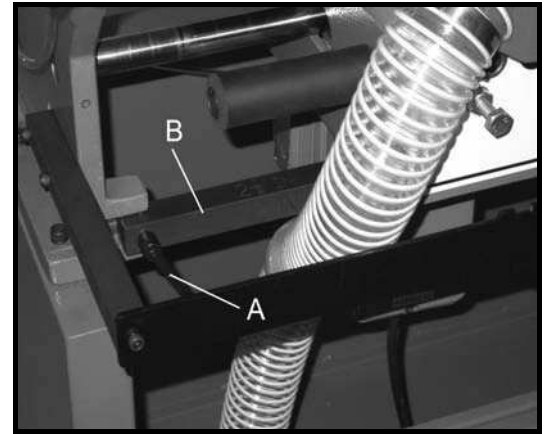

Figure 14

The pitch of the indication template must match the pitch of the template bar. Therefore, when turning the template bar for a new pitch, you must also change the indication template.

1. First notice how the notches on the indication template are grouped toward the right side of the machine. The indication template should always be oriented in this fashion.
2. Remove the socket head cap screw (C, Figure 15) at each end of the indication template, with a 5mm hex wrench.
3. The indication template that came installed on your machine contains the 1" and 2" pitch. The other indication template has the 1-1/2" and 2-1/2" pitch. Either flip the indication template, or replace it with the other one as needed, to match the pitch of the template bar.
4. Re-insert and tighten the socket head cap screws (C, Figure 15).

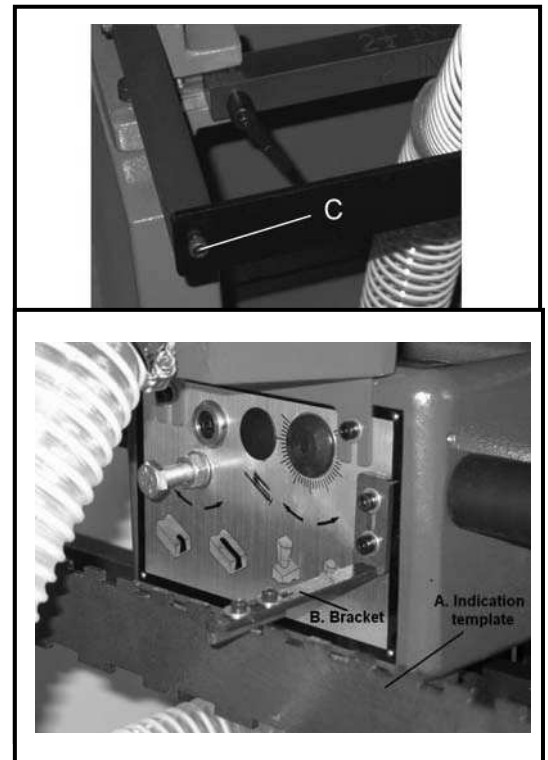

Figure 15

Fixed Chaser

The fixed chaser (Figure 16) provides a support on which the workpieces rest. The spacing between the "fingers" of the fixed chaser allows clearance for the cutter.

The 40-050 Dovetailer comes standard with three fixed chasers at 2", 2-1/2" and 3" pitches. (Pitch is the distance between the centers of the "fingers" see Figure 17).

NOTE: If you wish to use the 1-1/2" or 2-1/2" pitch on the template bar, you must replace the fixed chaser on the machine with one of the others provided.

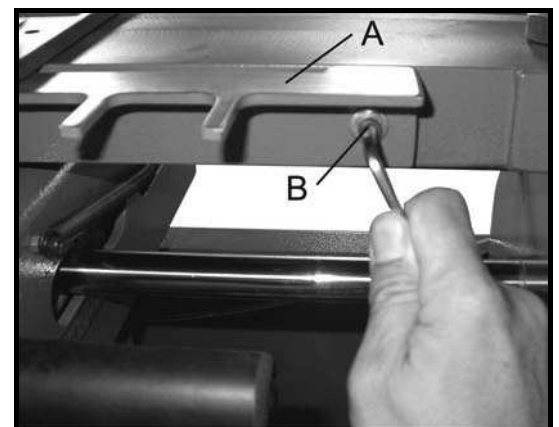

Figure 16

1. To replace the fixed chaser, remove the three M6 socket head cap screws and flat washers, using a 5mm hex wrench as shown in Figure 17. Remove the fixed chaser.
2. Install the new fixed chaser and make sure it is level with the main table.
3. Re-insert and tighten the socket head cap screws against the flat washers.

After mounting the fixed chaser, make sure it will correspond to your chosen pitch on the template bar. With the **machine power off**, slide the headstock across the length of the fixed chaser, allowing the cutter to move in and out of the spaces. If there is any interference between the cutter and one of the “fingers” on the fixed chaser, then try a different fixed chaser, or change the pitch of the template bar.

Horizontal and Vertical Fences

The workpieces will lie flush against the fences during cutting to ensure squareness. Two buffer pads made of polyethylene material are mounted to the fences - these provide a “chip breaker” effect to prevent chip-out on the left edges of the workpieces. They are designed so the cutter can bite into them without any damage to the cutter.

To adjust these fences, proceed as follows:

1. Place your **FRONT/BACK** workpiece on the horizontal table and against the fence/buffer pad. Move the headstock to the left edge of the workpiece, then slide it to the right, allowing the tracer pin to slide just a little into the template recesses, while observing through the dust hood window the progress of the cutter. This will give you an idea where the cuts will be made and how they will be spaced across the width of the workpiece.
2. For broad movement of the horizontal fence, loosen both locking handles on the horizontal fence (A and B, Figure 17) and slide the horizontal fence into position. Tighten both locking handles (A & B, Figure 17).
3. There is also a micro adjustment on the horizontal fence; loosen locking handle (A, Figure 17), but leave locking handle (B) tight. Loosen the screw rotate the knurled knob (D, Figure 17) as needed for precise positioning of the horizontal fence.
4. When finished, locking handle (A, Figure 17).

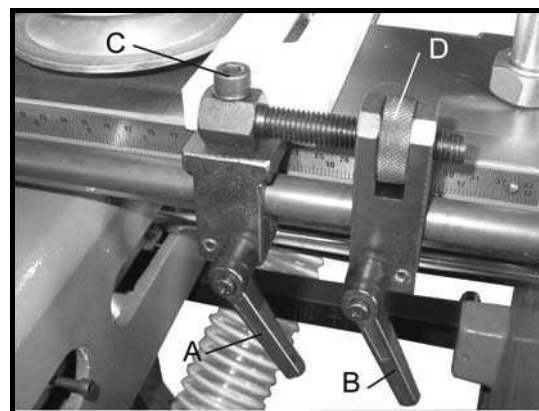

Figure 17

NOTE: Make sure locking handles (A & B, Figure 17) will not interfere with the headstock during operation.

5. Continue to check the spacing by sliding the headstock across, until the dovetail cuts will be distributed evenly across the width of the workpiece. NOTE: This is an approximate method of determining by eye where to place the workpiece. A scale in inches and millimeters is mounted to both horizontal and vertical tables, if you need more precise measurements for the location of the dovetail cuts.
6. Again, make sure the locking handles on the horizontal fence (A & B, Figure 17) are tightened. The position of the horizontal fence will now be used as the basis for locating the vertical fence.
7. Loosen the locking handle on the vertical fence.
8. As noted, the position of the horizontal fence will affect the position of the vertical fence. Therefore, if you are making a drawer that has a bottom groove, the vertical fence should be set so that the bottom groove in the drawer piece to be tenoned will go through the center of a tail. That means the bottom groove of the mortised piece will go through the center of a mortise. This will prevent the groove from being visible on the outside of the assembled drawer.

Important : To make proper dovetail cuts, the two fences must always be offset from each other by half the pitch of the template bar. That is, offset 1/2" when using the one-inch template; 3/4" when using the 1-1/2 template; 1" when using the two-inch template, and 1-1/4" when using the 2-1/2 inch template. The measuring scales on the horizontal and vertical tables are marked in 1/16" increments and millimeters.

9. Line up the vertical fence with the horizontal fence, then offset the vertical fence by exactly half the pitch of the template bar. See Figure 18.
10. This adjustment will cause the vertical work piece to be slightly offset to the right of the horizontal piece (as viewed from front of machine), thus ensuring the dovetails will correspond when the two pieces are assembled.
11. Tighten the locking handle on the vertical fence.

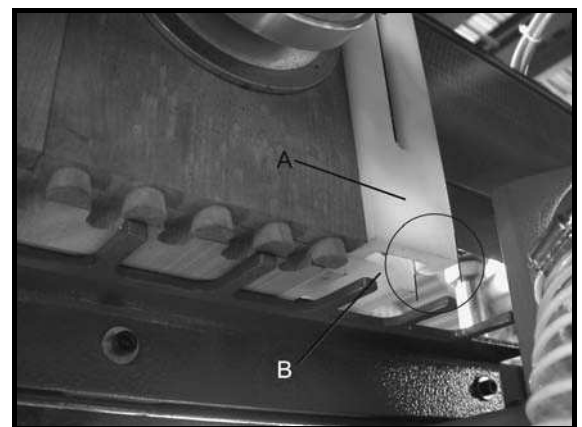

Figure 18
(view from rear of machine)

There are a total of four fences on the 40-050 Dovetailer - two vertical and two horizontal. These allow two sets of workpieces to be cut at the same time. If this is desired, position the other two fences in the same manner as the first two fences, remembering again to offset the vertical fence by half the pitch.

Buffer Pads

The polyethylene buffer pads, shown in Figure 18, have slots through which they are secured to the fences by screws. These buffer pads can be re-positioned if needed.

To adjust a buffer pad, loosen the two hex cap screws (shown in Figure 18) with a 13mm wrench. Slide the buffer pad as necessary. Retighten both hex cap screws when finished.

Cutter Height

This adjustment will change the height of the tail on the tenon (male) cut, and how deep the mortise (female) cut goes into the thickness of the workpiece.

1. Disconnect machine from power source.
2. Loosen the spindle lock screw (Figure 19) by turning it counterclockwise with a 6mm hex wrench.
3. Turn the spindle height adjustment screw (Figure 19) with a 5.5mm hex wrench, either clockwise to raise the cutter (increase the cutter depth), or counterclockwise to lower the cutter (decrease the cutter depth).
4. Tighten spindle lock screw by turning it clockwise.

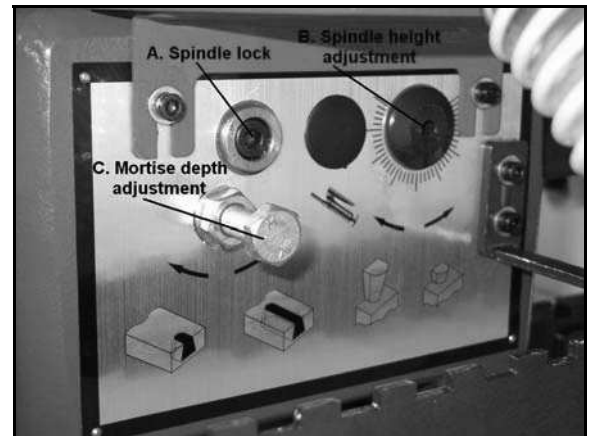

Figure 19

Mortise Depth

This adjustment ensures that the side pieces of your drawer will remain flush with the front and back pieces of the drawer. The correct fit will have the sides flush with the front and back of the drawer, without showing any of the mortise cut on the inside of the drawer.

The mortise depth adjustment bolt, shown in Figure 19, limits how far forward the headstock will go, and thus limits the length of your mortise cut.

1. Disconnect machine from power source.
2. Loosen the hex nut on the mortise depth adjustment bolt (Figure 19) by turning the hex nut counterclockwise with a 17mm wrench.

3. To decrease the depth of the mortise (female) cut, turn the bolt clockwise. To increase the depth of the mortise cut, turn the bolt counterclockwise.
4. Re-tighten the hex nut.

Thickness of Tenon Cut

To adjust the thickness of the tenon (male) cuts, you will change the depth of the tracer pin (A, Figure 20).

1. Disconnect machine from power source.
2. Loosen the locking handle (B, Figure 20).
3. Insert a 5.5mm hex wrench into the end of the adjustment screw (C, Figure 20) and turn the adjustment screw as needed. To decrease the thickness of the tenon cut, turn the adjustment screw counterclockwise. To increase the thickness of the tenon cut, turn the adjustment screw clockwise.
4. Tighten locking handle (B, Figure 20).



Figure 20

Tightness of Mortise / Tenon Fit

A proper dovetail fit should be snug with no gaps showing, but not overly tight as glue must later fill the joints. If the cuts seem correct, but the joint is simply too tight, or the joint is too loose, proceed as follows.

1. Disconnect machine from power source.
2. Remove the dust hood from the front of the headstock. Release one end of the spring on the headstock (see Figure 12) and pull the headstock away from the machine until the cutter becomes more accessible.
3. You will notice the cutter, shown in Figure 21, is slightly off center of the spindle. The spindle is eccentric and allows the cutter to be turned to a different position on the spindle.

 **WARNING** The cutter is very sharp!

Use caution when working with or around it.

4. Loosen both set screws on the spindle (Figure 21 by turning them counterclockwise with a 4mm hex wrench.
5. A scale is located just above the cutter, with a plus (+) and minus (-) sign. Moving the cutting edge of the cutter toward the plus (+) side of the scale will increase the size of the mortise cut and decrease the size of the tenon cut. Moving the cutting edge of the cutter toward the minus (-) side will decrease the size of the mortise cut and increase the size of the tenon cut.

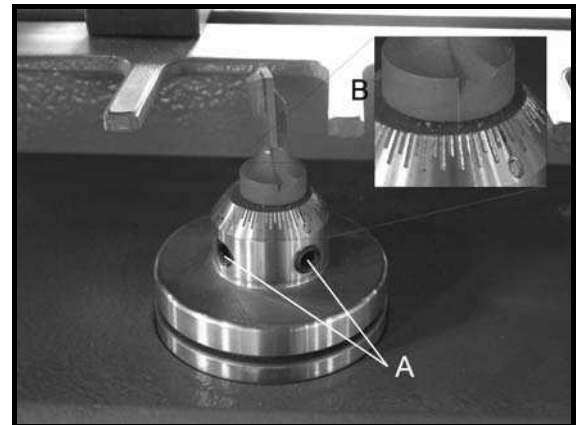

Figure 21

NOTE: One notch of the scale equals 1mm.

6. With your fingers on the shank portion of the cutter, carefully rotate the cutter toward the plus (+) or minus (-) position as needed.
7. When satisfied with the adjustment, tighten both set screws firmly.
8. Re-attach the spring on the headstock, and re-install the dust hood.

Drive Belt Tension

The tightness of the belt that drives the spindle has been adjusted at the factory. Further adjustment may be necessary after the machine receives some use, as the belt may stretch slightly during the “breaking in” process.

Belt tension can be adjusted by a socket head cap screw at the rear of the headstock (Figure 22) which slides the motor toward or away from the spindle. To tighten the belt, rotate this cap screw clockwise with a 6mm hex wrench. To loosen the belt, rotate the cap screw counterclockwise. The belt should be just tight enough to prevent it slipping on the spindle during operation.

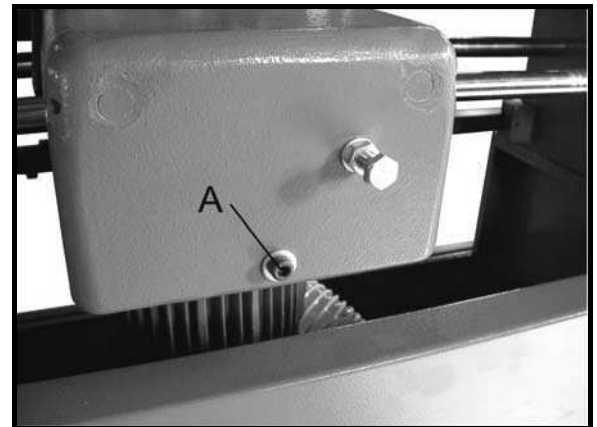

Figure 22

Replacing cutter

The cutter is very sharp; use caution when working with or around cutter. Disconnect machine from power source! Failure to comply may cause serious injury.

1. To replace the cutter, loosen both set screws (Figure 21) and carefully pull up on the cutter until it is free from the spindle.
2. Slide the new cutter down into the spindle, and align the cutting edge with your previous setting on the spindle scale.
3. Tighten both set screws.

Oil Output

Oil is distributed through the air lines for constant lubrication of the clamping system. The oil output can be adjusted by rotating the oil regulator knob (A, Figure 23). Turn the knob counterclockwise to increase oil output, clockwise to decrease oil output. The level of oil should be checked occasionally and re-filled as necessary. A minimum level is marked on the window of the oil cup (C, Figure 23). Refill by removing the screw (B, Figure 23) and pouring oil into the fill hole. When finished, re-install screw (B, Figure 23). Use standard air tool oil. This is available from your local distributor, or can be found in most hardware and tool stores.

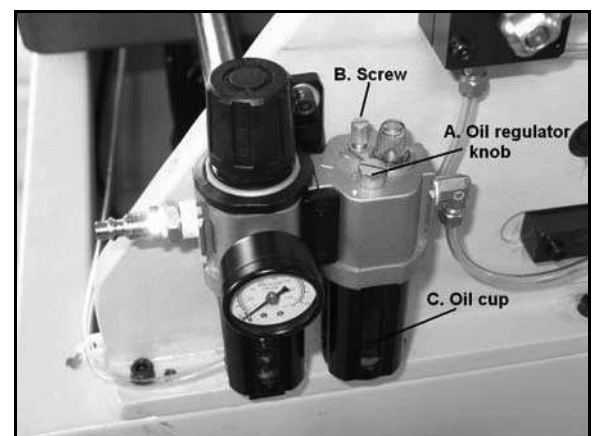

Figure 23

Operation

NOTE: The following are basic dovetailing procedures as they apply to this machine, and are not intended to be a full course of instruction in making dovetails.

Refer back to the terminology on page 2 if needed.

The Dovetailer can be used to make joints in drawers, boxes, cabinets, etc. Instructions in this manual are based upon making a drawer consisting of FRONT and BACK pieces, and two SIDE pieces. FRONT and BACK pieces are placed horizontally on top the machine table; SIDE pieces are placed vertically.

No matter the project, prevent mistakes by laying out the pieces beforehand according to how they will be assembled. Place them with the inside facing up, and label the mating edges.

Before cutting on what is to be the finished piece, the operator should make test cuts on scrap wood to make sure all settings and adjustments are correct.

IMPORTANT: Make sure the workpiece has been cut square before making dovetails. An out-of-square workpiece will result in poor dovetail joints.

1. Check that all the following has been set correctly

(See "Adjustments" above):

- proper pitch of Template Bar
- proper Indication Template
- Vertical and Horizontal Fence positions (offset from each other by half the pitch of the template bar)
- height of Clamping Cylinders for workpiece thickness
- proper Fixed Chaser, with no cutter interference
- height of Cutter

2. Move the headstock all the way to the right and out of the way.

3. Connect the air supply and the electrical power to the machine.



WARNING Keep fingers clear of clamping cylinders.

4. Place the drawer RIGHT SIDE against the vertical table and on top the fixed chaser. The RIGHT SIDE should be flush against the fence, with the bottom groove facing outward and opposite the fence (Figure 24).



Figure 24

5. Activate the clamping cylinder in front of the RIGHT SIDE workpiece.
 6. Place the drawer BACK on the horizontal table, and against the horizontal fence. Slide it flush against the RIGHT SIDE workpiece. The bottom groove on the BACK should face downward and opposite the fence. See Figure 25.
 7. Activate the clamping cylinder above the BACK workpiece.
 8. The BACK is now butting against the RIGHT SIDE so they are flush, with the RIGHT SIDE overlapping the edge of the BACK. Both workpieces should be firmly and evenly against the fences.
 9. Turn on the machine at the switch, and slide the headstock to the left edge of the workpiece. Move the cutter in sequence, left to right, allowing the tracer pin to move in and out of the template slots. See Figure 26. You can watch the progress of the cutter through the window of the dust hood.
- NOTE:** Do not rush the cut; allow the cutting unit to do the work.

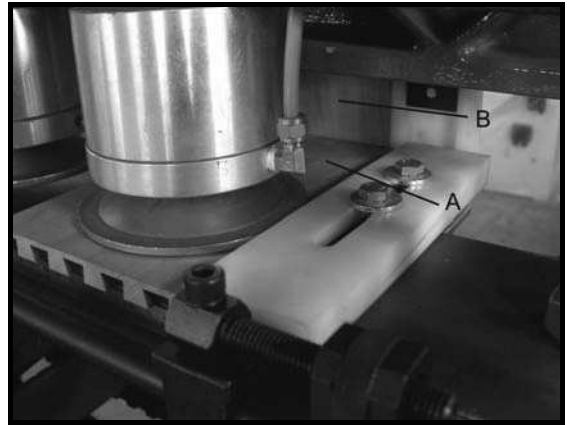

Figure 25

10. When finished, slide the headstock out of the way and unclamp the workpieces by turning the clamping cylinder levers to “off”.
11. Fit the BACK and RIGHT SIDE together and examine the joint. If the joint is not satisfactory, make any needed corrections to your settings as explained under “Adjustments.” If the joint is satisfactory, proceed with the next cut as follows.
12. Insert the LEFT SIDE piece and clamp it in vertical position and against the fence. (NOTE: The bottom groove on the LEFT SIDE will face outward and toward the fence.)



Figure 26

13. Turn the BACK 180 degrees and clamp it in the horizontal position against the fence. (NOTE: The bottom groove on the BACK workpiece will still be face down, but toward the fence.)
14. Make the cut, and then continue the dovetailing procedure with the FRONT piece, making cuts until all four joints of the drawer have been cut.

TIP: When using drawer side widths that are not “whole inch” sizes, you may wish to gauge off the top of the drawer rather than the bottom when placing workpieces in the machine. Doing this will improve the look of the drawer by providing a full tenon near the top of the drawer and the half-tenon will end up at the bottom. See Figure 27.

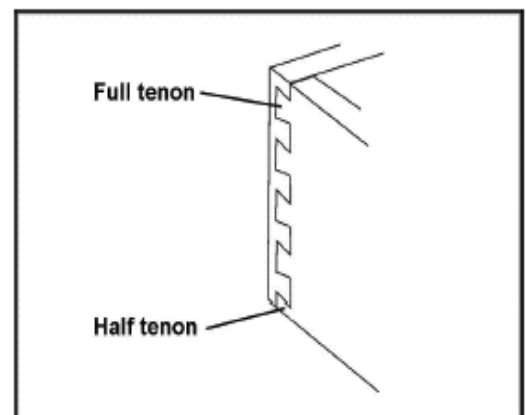

Figure 27

Preventing Chip Out

As noted previously, when the SIDE and FRONT/BACK pieces are inserted into the machine, they are offset a bit so they'll match correctly when assembled. In other words, the SIDE will rest slightly to the right of the FRONT/BACK in the machine. This leaves the right edge of the SIDE exposed without the "chip breaker" effect that the FRONT/BACK provides for the rest of the SIDE (see Figure 28). This may result in an unsatisfactory cut at the edge of the SIDE.

This problem is resolved simply by taking a two inch-plus wide "back-up" board, of the same thickness as the workpiece, and clamping it horizontally next to the FRONT/BACK piece, so that it backs up the exposed edge of the SIDE, as shown in Figure 28. You can use this piece over and over again.

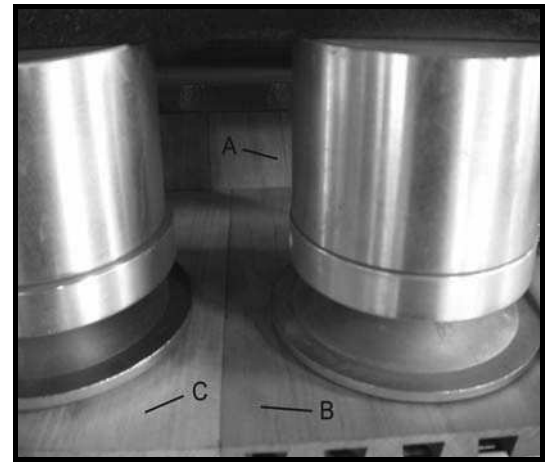

Figure 28
(view from rear of machine)

Dovetails in Plywood

Because plywood handles a bit differently than solid stock, here are some tips to follow:

1. When using plywood, the layers tend to be more fragile. Therefore, the operator should keep the movement of the cutting unit consistent and proceed relatively slowly.
2. On the rounded arcs of the tenon cuts, you may lose a bit of the top layer. This is to be expected with plywood, and does not affect either the look or the strength of the assembled dovetail joint. Rather, the strength of the dovetailed corner comes from the flat side of the tenons.
3. Plywood has a tendency to chip out on exposed edges. A back-up board may be necessary (see Figure 28).

Maintenance

⚠ WARNING Before doing maintenance on the machine, disconnect it from the electrical supply and the air supply, and release any residual air from the lines. Failure to comply may cause serious injury.

If the power cord is worn, cut, or damaged in any way, have it replaced immediately.

The horizontal and vertical tables and other exposed metal parts should be kept clean and free of rust. A coat of paste wax will help protect the tables from tarnishing.

After each day's use, brush or blow out dust and debris from the cutter, table, motor, etc.

Keep the clamping cylinders clean to prevent debris adhering to them, which can scar workpieces.

Keep clean the travel rods upon which the headstock slides.

Lubrication

The linear bushings by which the headstock travels on the rods are pre-lubricated and sealed; they do not require additional lubrication.

The spindle unit is also sealed and requires no lubrication.

Occasionally check the oil level in the oil regulator cup (see Figure 24). Add more oil as needed. Use standard air tool oil.

List of Parts for Dovetailer

D65-01A

PART NO.	REF NO.	DESCRIPTION	SPECIFICATION	QTY
D6501A-01	D65-1010	WORK TABLE		1
D6501A-02	D65-1050	BASE GUIDE ROD		2
D6501A-03	BB	HEX. SOCKET SET SCREW	M6x16	4
D6501A-04		SWITCH BRACKET		1
D6501A-05	FW	FLAT WASHER	M6x16x2	2
D6501A-06	BB	HEX. SOCKET CAP SCREW	M6x16	2
D6501A-07		SWITCH	1HP.230V	1
D6501A-08	BB	HEX. SOCKET CAP SCREW	M4x12	2
D6501A-09		SCALE		1
D6501A-10		FIXED CHASER		1
D6501A-11		FIXED CHASER		1
D6501A-12		FIXED CHASER		1
D6501A-13	FW	FLAT WASHER	M6x16x2	3
D6501A-14	BB	HEX. SOCKET CAP SCREW	M6x25	3
D6501A-15		TEMPLATE BAR		1
D6501A-16	AL	LEVER	M6x35	2
D6501A-17		LINK		2
D6501A-18		SPRING WASHER	M6x10x1	4
D6501A-19	BB	HEX. SOCKET CAP SCREW	M6x35	4
D6501A-20		INDICATION TEMPLATE		1
D6501A-21		INDICATION TEMPLATE		1
D6501A-22	BB	HEX. SOCKET CAP SCREW	M6x16	2
D6501A-23		FENCE SLIDING BAR		2
D6501A-24	BB	HEX. SOCKET CAP SCREW	M6x10	2
D6501A-25		FENCE BASE		4
D6501A-26	BB	HEX. SOCKET CAP SCREW	M6x10	4
D6501A-27	AL	LEVER	M8x25	4
D6501A-28		FENCE		4
D6501A-29	FW	FLAT WASHER	M8x24x3	8
D6501A-30		HEX. SCREW	M8x20	8
D6501A-31		ADJ. SCREW		1
D6501A-32	BB	HEX. SOCKET CAP SCREW	M8x30	1
D6501A-33	D75-4150	ADJ, NUT		1
D6501A-34		ADJ. SCREW SEAT		1
D6501A-35	BB	HEX. SOCKET CAP SCREW	M6x10	1
D6501A-36	AL	LEVER	M8x25	1

List of Parts for Dovetailer

D65-01A

PART NO.	REF NO.	DESCRIPTION	SPECIFICATION	QTY
D6501A-37	D65-1380	BUFFER PAD		2
D6501A-38	FW	FLAT WASHER	M6x13x1	2
D6501A-39	BB	HEX. SOCKET CAP SCREW	M6x20	2
D6501A-40		POINTER		1
D6501A-41	FW	FLAT WASHER	M5	1
D6501A-42	BB	HEX. SOCKET CAP SCREW	M5x10	1

List of Parts for Dovetailer

D65-02A

PART NO.	REF NO.	DESCRIPTION	SPECIFICATION	QTY
D6502A-01		SPINDLE ASS'Y		1
D6502A-02	D75-2110	BEARING HOUSING		1
D6502A-03	BG6005	BEARING	6005 TB. T63	1
D6502A-04	D75-2120	BEARING LOCK PIECE		1
D6502A-05	D75-2100	SPINDLE		1
D6502A-06	BS	HEX. SOCKET SET SCREW	M8x10	1
D6502A-07	D75-2130	BUSHING		1
D6502A-08	DS1.DS2	SPRING		1
D6502A-09	GB6005	BEARING	6005 TB. T63	1
D6502A-10	D75-2240	BEARING LOCK PIECE		1
D6502A-11	BB	GREASE NIPPLE	M6	1
D6502A-12	D65-1060	SPINDLE BASE		1
D6502A-13	D65-1090	SPINDLE ADJ. GEAR		1
D6502A-14	FW	FLAT WASHER	M8x24x3	1
D6502A-15	BA	HEX. HD. SCREW	M8x20	1
D6502A-16	D65-1100	STOP BLOCK		1
D6502A-17	D65-1110	BUSHING		1
D6502A-18	BB	HEX. SOCKET CAP SCREW	M8x65	1
D6502A-19	D65-1190	FACE PLATE		1
D6502A-20	PG	CAP	Φ22	1
D6502A-21	FW	FLAT WASHER	M10x20x2	1
D6502A-22	HN	HEX. NUT	M10	1
D6502A-23	BA	HEX. HD. SCREW	M10x150	1
D6502A-24	D65-1140	MODEL PIN		1
D6502A-25	D65-1130	ADJ. SCREW		1
D6502A-26	AL	LEVER	M6x25	1
D6502A-27	D65-1080	SHAFT		2
D6502A-28	BS	HEX. SOCKET SET SCREW	M6x12	4
D6502A-29	D65-1070	SLIDER		1
D6502A-30	LM	BEARING	LM16UUT	4
D6502A-31	SL	SEAL	KC 16x28x7	4
D6502A-32	PR	CIRCLIP	R28	4
D6502A-33	LM	BEARING	LM25UUT	4
D6502A-34	SL	SEAL	KC 25x40x7	4
D6502A-34	PR	CIRCLIP	R40	4
D6502A-36	HN	HEX. NUT	M5	1

List of Parts for Dovetailer

D65-02A

PART NO.	REF NO.	DESCRIPTION	SPECIFICATION	QTY
D6502A-37	BB	HEX. SOCKET CAP SCREW	M5x35	1
D6502A-38	TS	SPRING		1
D6502A-39	HN	HEX. NUT	M5	1
D6502A-40	BB	HEX. SOCKET CAP SCREW	M5x20	1
D6502A-41	MT	MOTOR	1Hp. 230V	1
D6502A-42	D65-1170	PULLEY		1
D6502A-43	D75-2310	FLAT WASHER		1
D6502A-44	BB	HEX. SOCKET CAP SCREW	M6x16	1
D6502A-45	BS	HEX. SOCKET SET SCREW	M5x10	1
D6502A-46	FB	BELT	670-25	1
D6502A-47	D65-1120	MOTOR BRACKET		1
D6502A-48	FW	FLAT WASHER	M8x18x2	2
D6502A-49	SW	SPRING WASHER	M8	2
D6502A-50	BB	HEX. SOCKET CAP SCREW	M8x40	2
D6502A-51	FW	FLAT WASHER	M8x18x2	1
D6502A-52	BB	HEX. SOCKET CAP SCREW	M8x100	1
D6502A-53	HN	HEX. NUT	M10	2
D6502A-54	D65-6020	HANDLE		2
D6502A-55	JBB120207	SPONGE	120x20x7	2
D6502A-56	SC	SCALE		1
D6502A-57	D65-1210	DUST HOOD		1
D6502A-58	FW	FLAT WASHER	M5x12x1	2
D6502A-59	BB	HEX. SOCKET CAP SCREW	M5x16	2
D6502A-60	D65-1270	WINDOW		1
D6502A-61	BC	RD. HD. SCREW	M4x6	4
D6502A-62	CR	KNIFE		1
D6502A-63	BA	HEX. HD. SCREW	M10x60	1
D6502A-64	FW	FLAT WASHER	M10x28x3	1
D6502A-65	HN	HEX. NUT	M10	1

List of Parts for Dovetailer

D65-03A

PART NO.	REF NO.	DESCRIPTION	SPECIFICATION	QTY
D6503A-01		CYLINDER ASS'Y		4
D6503A-02	D75-4110	CYLINDER BODY		4
D6503A-03	115-4480	PISTON		4
D6503A-04	WG	WEARING	80x75x6	4
D6503A-05	PR	PISTON BACKING	80x64x5.7	4
D6503A-06	d75-4120	PISTON ROD		4
D6503A-07	SW	SPRING WASHER	M12	4
D6503A-08	HN	HEX. NUT	M12	4
D6503A-09	115-4500	END COVER		4
D6503A-10	OR	O-RING	G80	4
D6503A-11	OR	O-RING	P20	4
D6503A-12	DH	LOCKING PIECE	DH25	4
D6503A-13	D75-4070	CLAMPING DISC		4
D6503A-14	FW	FLAT WASHER	M8x24x3	4
D6503A-15	BA	HEX. HD. SCREW	M8x16	4
D6503A-16	JNL01P006H	MALE ELBOW CONNECTOR	PT-1/8"xΦ6mm	8
D6503A-17	D65-1550	HOLDER BRACKET		1
D6503A-18	D75-6010	FLAT WASHER		4
D6503A-19	AL	LEVER	M10x35	4
D6503A-20	D75-4100	STUD		4
D6503A-21	NH	HEX. NUT	M20	16
D6503A-22	FW	FLAT WASHER	M20x45x3	8
D6503A-23	D75-1370	HOLDER BRACKET		1
D6503A-24	JHS8812	CONTROL VALVE	3/2-Way	4
D6503A-25	312-0260	HANDLE		4
D6503A-26	BS	HEX. SOCKET SET SCREW	M5x5	4
D6503A-27	BB	HEX. SOCKET CAP SCREW	M5x45	8
D6503A-28	JNS01P006H	MALE CONNECTOR	PT-1/8"xΦ6mm	8
D6503A-29	JNT01P006H006H	T-CONNECTOR	PT-1/8"xΦ6mm	3
D6503A-30	JNL01P006H	MALE ELBOW CONNECTOR	PT-1/8"xΦ6mm	1
D6503A-31	FA	AIR SUPPLY UNIT	MACP 300-10A	1
D6503A-32	JMINI03	AIR CONTROL VALVE	PT-1/8"	1
D6503A-33	RC	ADAPTER	1/8"x1/4"	1
D6503A-34	MP	MALE COUPLING	PT-1/4"x1/4"	1
D6503A-35	JNL03P006H	MALE ELBOW CONNECTOR	PT-3/8"xΦ6mm	1
D6503A-36	FW	FLAT WASHER	M6x16x2	2

List of Parts for Dovetailer

DT65-03A

PART NO.	REF NO.	DESCRIPTION	SPECIFICATION	QTY
D6503A-37	BB	HEX. SOCKET CAP SCREW	M6x16	2

List of Parts for Dovetailer

D65-04A

PART NO.	REF NO.	DESCRIPTION	SPECIFICATION	QTY
D6504A-01	D65-3010	CABINET		1
D6504A-02	D65-3020	DOOR		1
D6504A-03	DL	DOOR LOCK		1
D6504A-04	SW	SPRING WASHER	M8	6
D6504A-05	BB	HEX. SOCKET CAP SCREW	M8x30	6
D6504A-06	BS	SOCKET SET SCREW	M8x20	6
D6504A-07	FH	HOSE	2-1/2"	1
D6504A-08	HC	DUST HOOD CLAMP	2-3/4"	2
D6504A-09	CSR10040	DUST HOOD		1
D6504A-10	BB	HEX. SOCKET CAP SCREW	M6x10	4
D6504A-11	BE	EYE BOLT	M10	2
D6504A-12	KEY	HING PIN		2

D65-01A

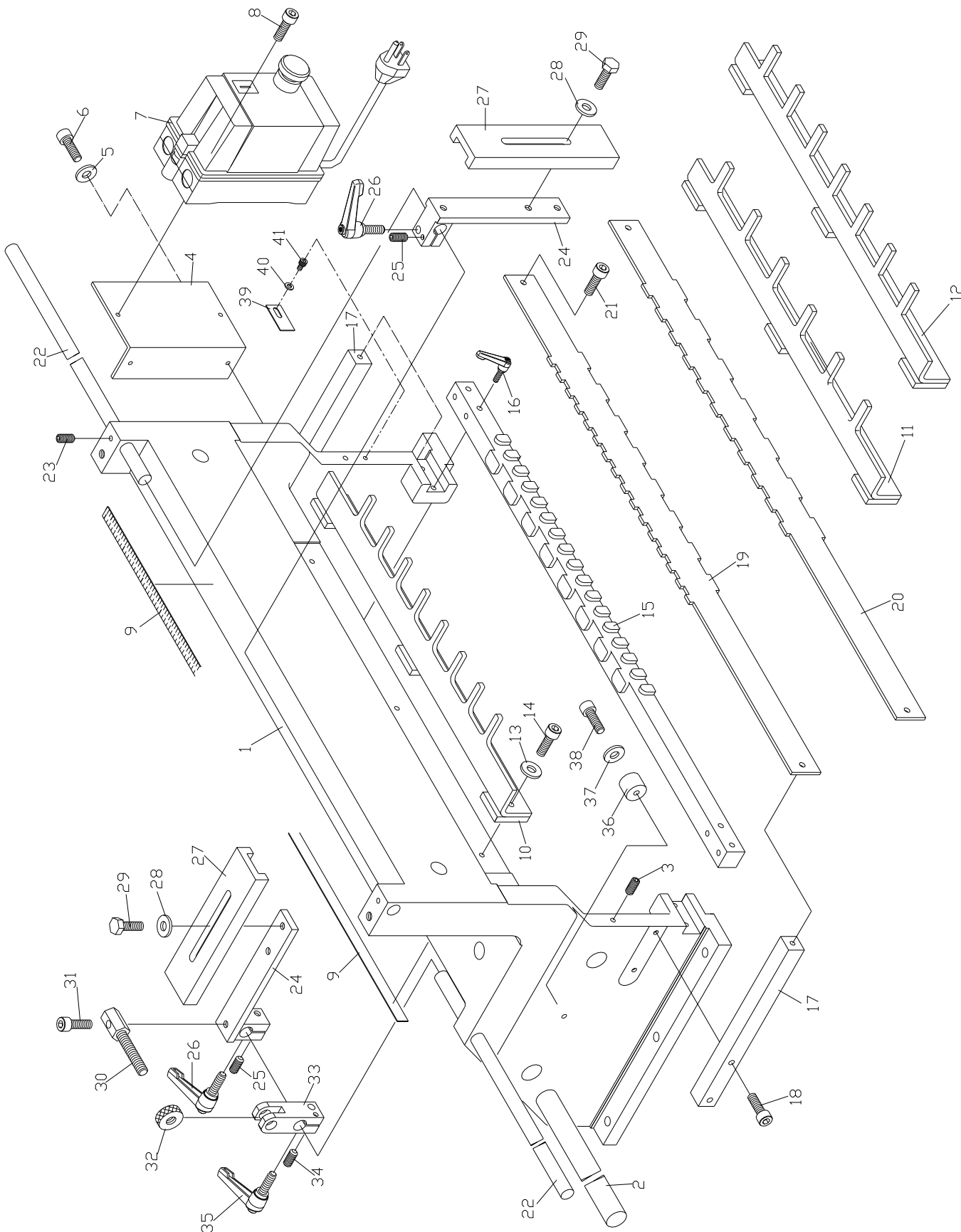

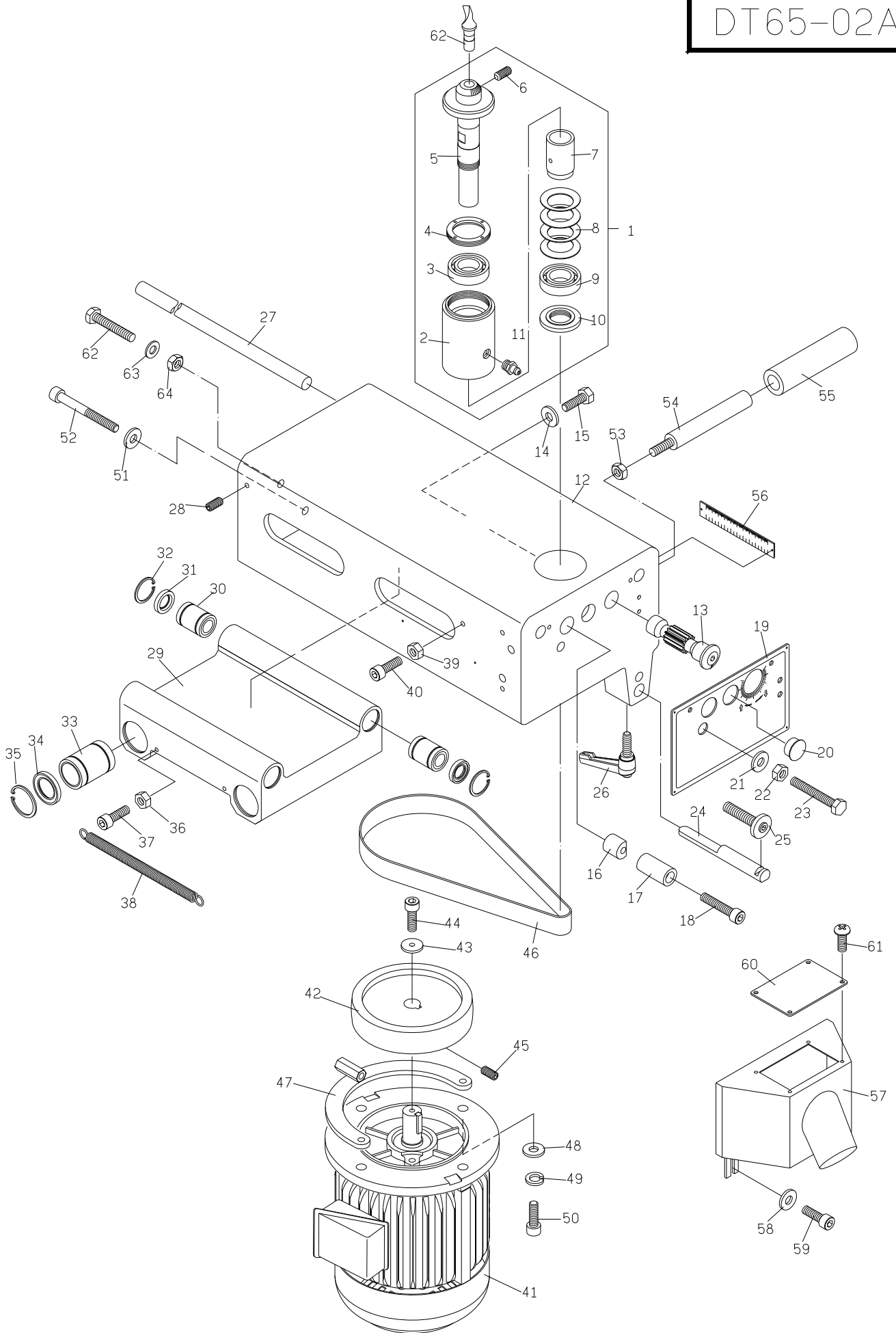

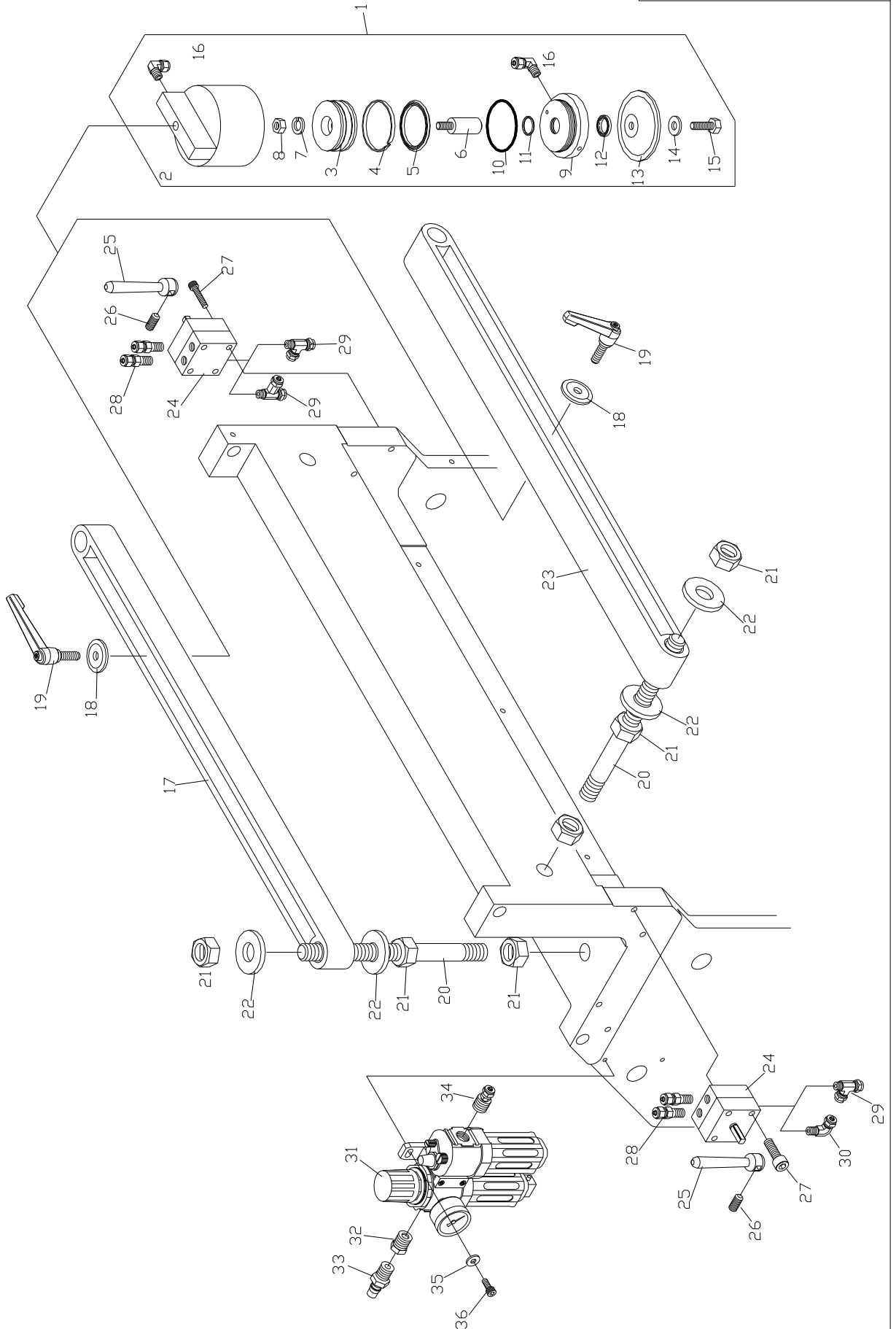

D65-04A

