



Motor Model: TFP63b/6 EU

ELECTRICAL DATA		
	60 Hz	50 Hz
Horsepower	0.21	0.18
Kilowatt	0.16	0.13
Speed – RPM	1080	900
Voltage	280/480	230/400
Phase	3	
Full Load Amp	1.6 / 0.9	1.4 / 0.8
Power Factor		0.82
Nominal Eff.		58%
Service Factor	1.0	1.0
KVA Code		
FL Amps @ 208V		
Starting Current	4.8/2.7	4.2/ 2.4
Coil Resistance	Ohms	

ACCESSORIES			
BRAKE	O.E.G. Model 63-SMS		
- Volts	24Vdc	103Vdc	230Δ/400Y-50Hz
- Volt-Amp	75		
Max Torque	10 Nm	89 in-lbs	
Air Gap	0.3mm Min.	0.7mm Max.	
Open/Close Times	5ms open	20ms close	
Rectifier	½ Bridge 44.5%	Full Bridge 89%	
Sensor Bearing	Not available for motor size 63		
Pulse/Rev	48		
Period Accuracy	+/- 3%		
Phase shift output	90°		
Phase shift output signal tolerance.	+/- 30°		

Load	Eff %	P.F.	Eff %	P.F.
50%				
75%				
100%				

FULL LOAD TEMPERATURE RISE		
FL Temp Rise	°C	°F

Image Links		
2D PDF	3D STP	Wiring

GENERAL DATA			
Frame Size	63		
Frame Enclosure	TEFC		
Mounting	B14 – B5 – B3 – B35 – B34		
Insulation Class	F		
Duty	S1 Continuous		
NEMA Design	B		
Frame Material	Diecast Aluminum		
Ingress Protection	54	55	56 66
Tropicalization	Optional		
Cable Entry	M16 Gland		
Paint	RAL 9006	Polyester Epoxy	
Paint	WHITE ALUMINUM		
Brake Cover	TVT BLUE	RAL 5010 Epoxy	
- Material	Pressed Steel	Stainless Steel	
Weight	13.2 Lbs.	6 Kg	

ELECTRICAL CONNECTIONS		
Leads	9 leads	6 leads
Terminal Block	9 lugs	6 lugs
Circuits	YY/Y	Δ/Y
Thermal Protection	NC 130°C Thermostat	24Vdc max Thermistor

MECHANICAL DATA			
DE Bearing	6202	ZZ	6202 2RS
NDE Bearing	6202	ZZ	6202 2RS
dB No-Load			
Rotor Wk <sup>2</sup> Lb-Ft <sup>2</sup>			
Comp Ring (wavy washer)	DRIVE END		

TORQUE VALUES	Nm	% FLT
Max Torque	1.76	200
Starting Torque	1.76	200
Full Load Torque	0.88	100

SITE CONDITIONS		
Ambient Temp	40°C	104°F
Altitude Above Sea Level	1000 Meters	



Options in BLUE available Ex-Works USA.  
Options in RED are available Ex-Works Italy

Made in Italy  
Assembled in U.S.A.

TVT AMERICA LLC  
Hollister, MO 65672  
P. 866 285 5055



UL 1004 C22.2 N°100--95

### MOUNTING FORMS

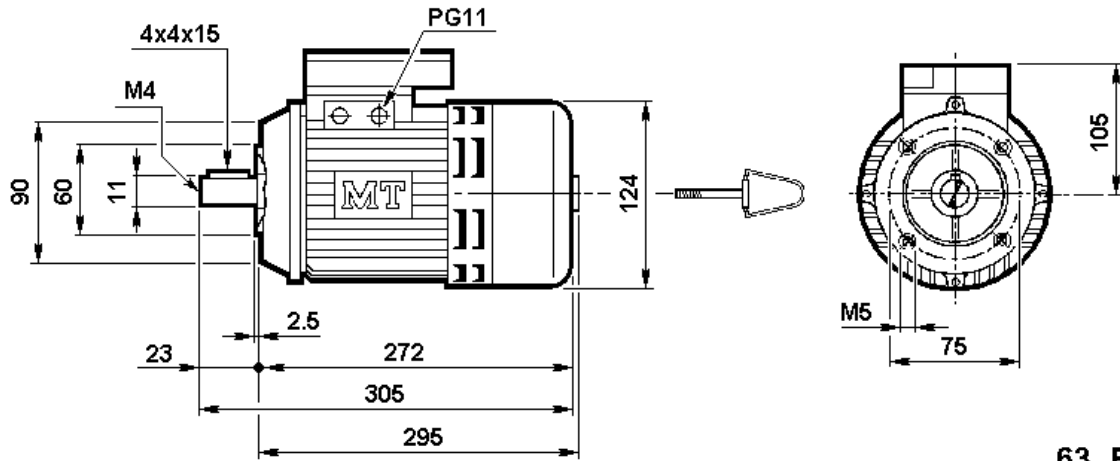

**63 B14**

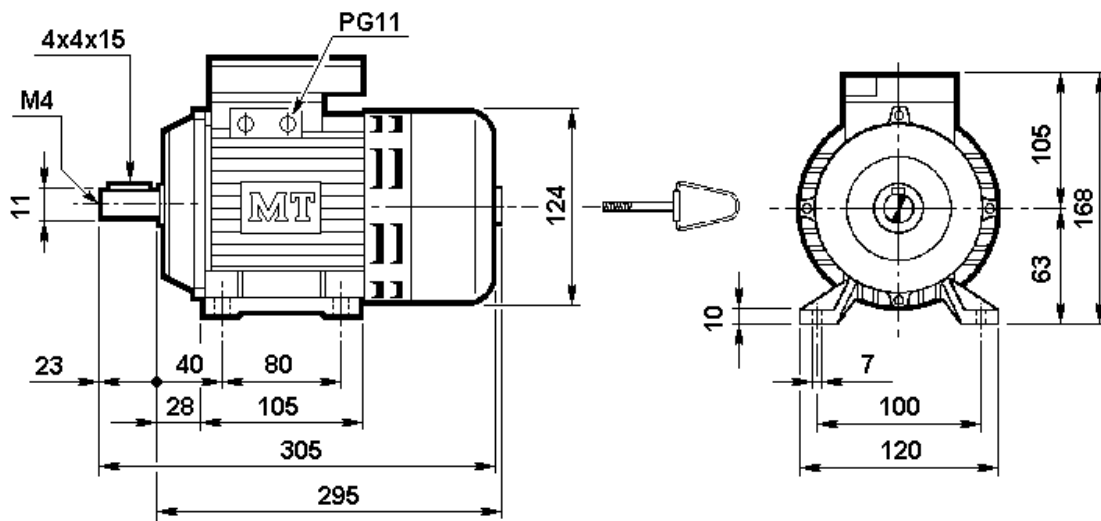

**63 B3**

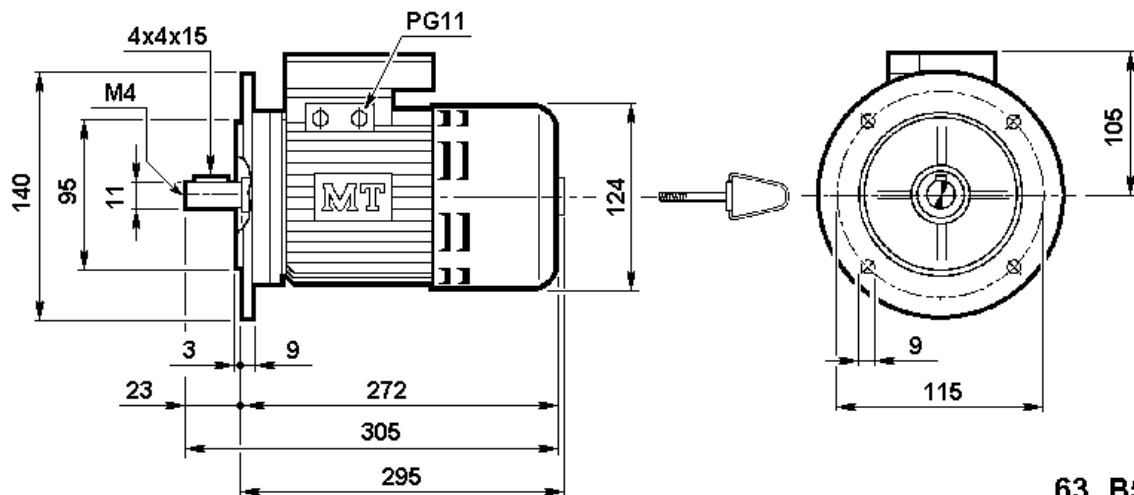

**63 B5**



STANDARD OUTPUT SHAFT

REDUCED OUTPUT SHAFT

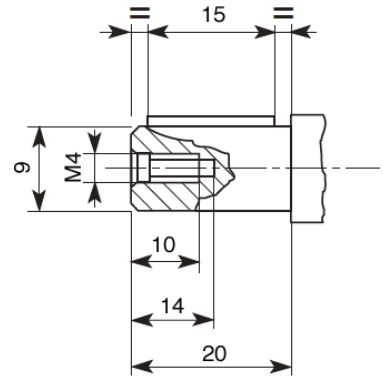
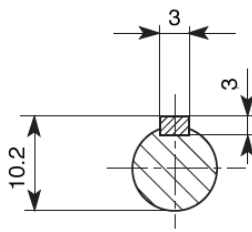
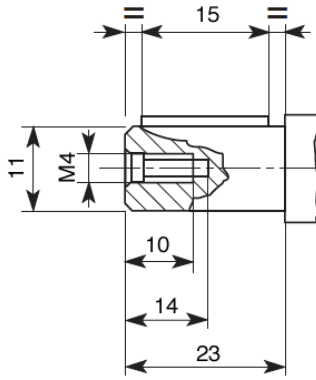
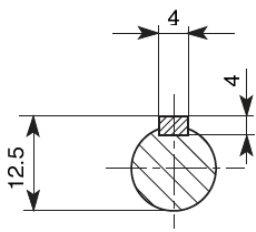

OPTIONAL MOUNTING FORMS