

ASUNA

ASUNA 7750P PINK SPACEFLEX MOTORIZED TREADMILL



*Owner's Manual
Made in China*

INDEX

IMPORTANT SAFETY INFORMATION.....	1
EXPLODED DIAGRAM.....	2-3
PARTS LIST.....	4-6
TOOLS & HARDWARE.....	7
ASSEMBLY INSTRUCTIONS.....	8-9
FOLDING INSTRUCTIONS.....	10
MOVING INSTRUCTIONS.....	11
SPECIFICATIONS.....	12
IMPORTANT ELECTRICAL INFORMATION.....	13
OPERATING INSTRUCTIONS.....	14
DISPLAY CONSOLE.....	15-20
MAINTENANCE INSTRUCTIONS.....	21
MAINTENANCE GUIDELINES.....	22
LUBRICATION.....	23



ATTENTION:

Please verify that all parts associated with this product are in good condition and accounted for. During the assembly process, please be sure to follow each step accordingly as it has been explained within this manual.

WARNING: During assembly, it is recommended that all bolts be tightened by hand. Upon completing assembly, bolts should be secured using the wrench provided. To avoid injury, check bolts carefully before use.

IMPORTANT: Read all instructions carefully before using this product. Retain owner's manual for future reference. For customer service, please contact: support@sunnyhealthfitness.com

IMPORTANT SAFETY INFORMATION

We thank you for choosing our product. To ensure your safety and health, please use this equipment correctly. It is important to read this entire manual before assembling and using the equipment. Safe and effective use can only be achieved if the equipment is assembled, maintained, and used properly. It is your responsibility to ensure that all users of the equipment are informed of all warnings and precautions.

1. Before starting any exercise program, you should consult your physician to determine if you have any medical or physical conditions that could put your health and safety at risk or prevent you from using the equipment properly. Your physician's advice is essential if you are taking medication that affects your heart rate, blood pressure, or cholesterol level.
2. Be aware of your body's signals. Incorrect or excessive exercise can damage your health. Stop exercising if you experience any of the following symptoms: pain, tightness in your chest, irregular heartbeat, shortness of breath, lightheadedness, dizziness, or feelings of nausea. If you do experience any of these conditions, you should consult your physician before continuing with your exercise program.
3. Keep children and pets away from the equipment. The equipment is designed for adult use only.
4. Use the equipment on a solid, flat level surface with a protective cover for your floor or carpet. To ensure safety, the equipment should have at least 8 feet (240CM) of free space behind it and 2 feet (60CM) on each side. Do not place the treadmill on any surface that blocks air openings. To protect the floor or carpet from damage, place a mat under the treadmill.
5. Ensure that all nuts and bolts are securely tightened before using the equipment. The safety of the equipment can only be maintained if it is regularly examined for damage and/or wear and tear.
6. Always use the equipment as indicated. If you find any defective components while assembling or checking the equipment, or if you hear any unusual noises coming from the equipment during exercise, discontinue use of the equipment immediately and do not use until the problem has been rectified.
7. Wear suitable clothing while using the equipment. Avoid wearing loose clothing that may become entangled in the equipment.
8. Do not place fingers or objects into the moving parts of the equipment.
9. The maximum weight capacity of this unit is 220 pounds (100 KG).
10. The equipment is not suitable for therapeutic use.
11. To avoid bodily injury and/or damage to the product or property, proper lifting and moving are required.
12. Your product is intended for use in cool and dry conditions. You should avoid storage in extreme cold, hot or damp areas as this may lead to corrosion and other related problems.
13. This equipment is designed for indoor and home use only; it is not intended for commercial use!

Exploded Diagram 1

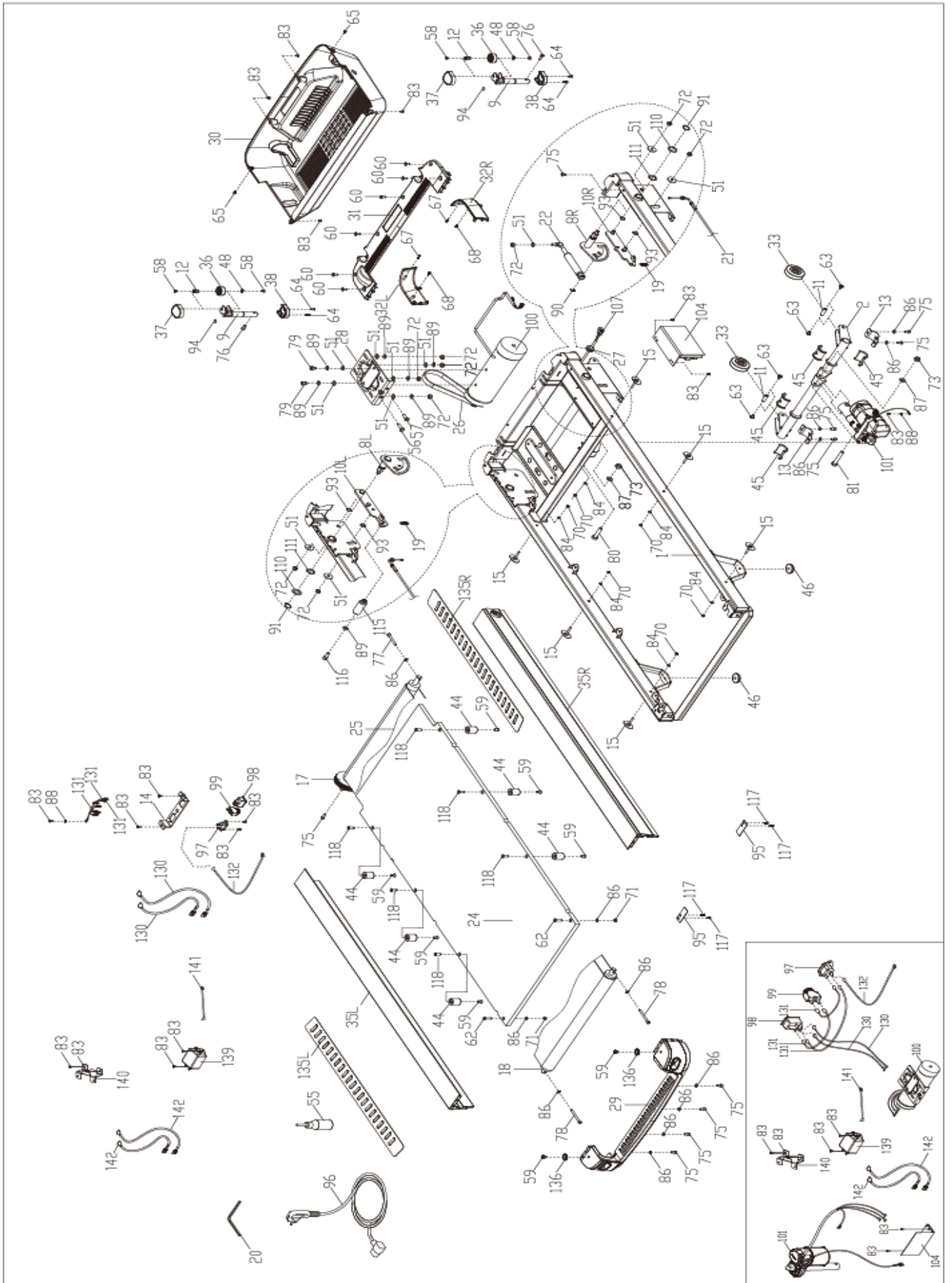

Exploded Diagram 2

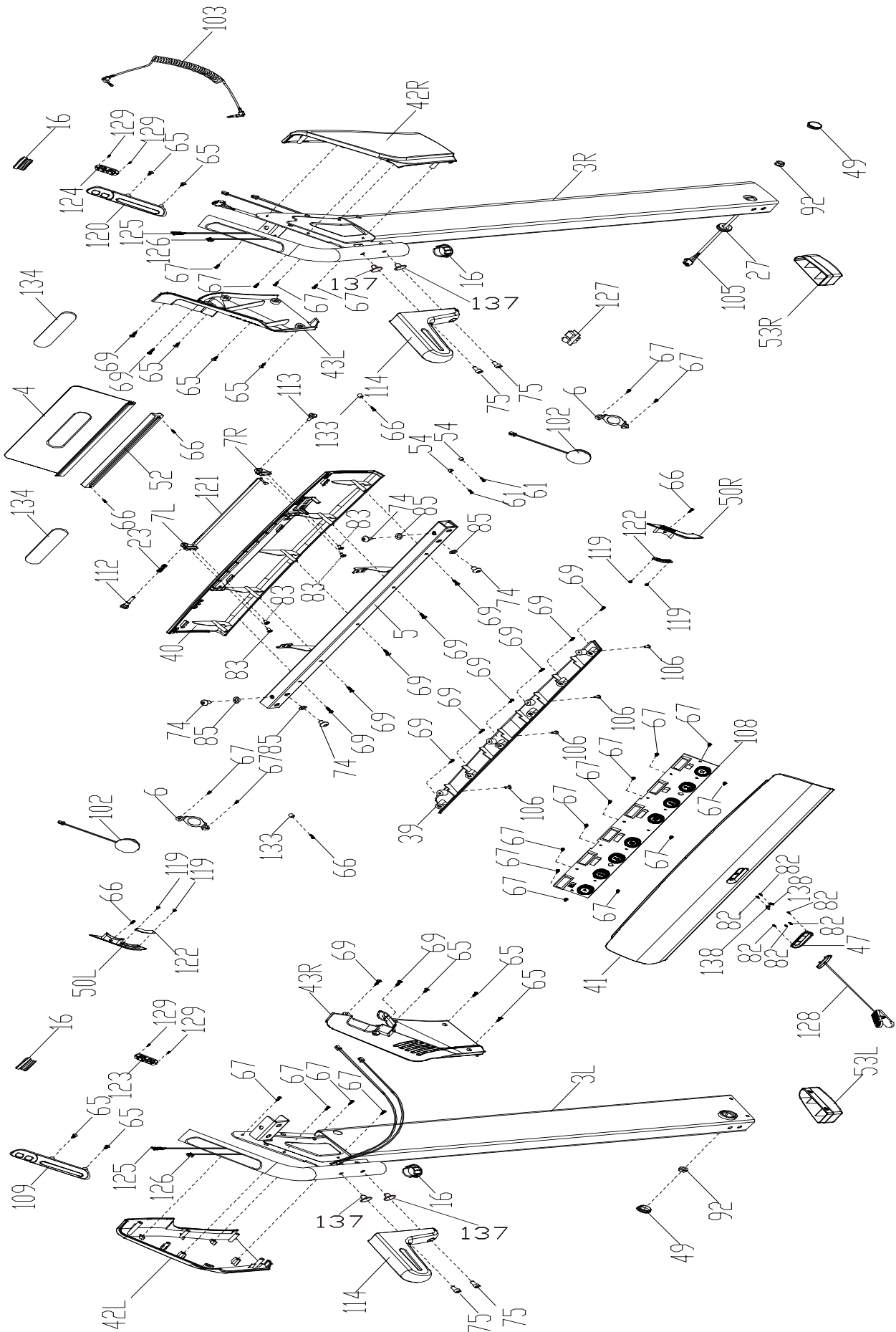

Parts List

NO.	DESCRIPTION	SPEC.	QTY
1	Main Frame		1
2	Incline Bracket		1
3L/ R	Handlebar		2
4	Tablet Bracket		1
5	Meter Bracket Horizontal Tube		1
6	Loudspeaker Fixed Seat		2
7L/ R	Tablet Bracket Fixed Seat		2
8L/ R	Adjusting Sheet		2
9	Supporting Wheel Fixed Bracket		2
10L/ R	Choice Sheet		2
11	Transportation Wheel Axis		2
12	Supporting Wheel Axis		2
13	Incline Bracket U Shape Fixed Seat		2
14	Power Fixed Connector		1
15	Edging Buckle		6
16	Handrail Stopper		4
17	Font Roller		1
18	Rear Roller		1
19	Extension Spring		2
20	Allen Wrench		1
21	Cable		1
22	Cylinder		1
23	Compression Spring		1

NO.	DESCRIPTION	SPEC.	QTY
24	Running Board		1
25	Running Belt		1
26	Multi-groove Belt		1
27	Ring Wire Plug		2
28	Motor Seat		1
29	Rear Cover		1
30	Motor Under Cover		1
31	Motor Upper Cover		1
32L/ R	Side Decorative Cap of Motor Cover		2
33	Transportation Wheel		2
34	N/A		-
35 L/R	Side Rail		2
36	Supporting Transportation Wheel		2
37	Supporting Wheel Upper Cover		2
38	Supporting Wheel Under Cover		2
39	Meter Under Cover		1
40	Meter Back Cover		1
41	Meter Panel		1
42 L/R	Outer Side Cover of Meter		2
43 L/R	Meter Left Inner Side Cover		2
44	Cushion		6
45	Incline Axle Sleeve		4
46	Adjusting Foot Pad		2

NO.	DESCRIPTION	SPEC.	QTY
47	Safety Key Seat		1
48	C-shape Snap Ring	Φ10	2
49	Upright Stopper		2
50 L/R	Loudspeaker Light Shade		2
51	Flat Washer	Φ9*Φ23*T1.5	11
52	Light Transmitting Plate		1
53 L/R	Handlebar Stopper		2
54	Module Fixer		2
55	Silicone Oil		1
56	Bolt	M8*20	1
57	Bolt	M8*25	1
58	Screw	M5*8	4
59	Screw	M6*12	8
60	Screw	M6*20	6
61	Screw	ST3.0*15	2
62	Screw	M6*28	2
63	Screw	M6*12	4
64	Screw	ST3.0*20	4
65	Screw	ST4.0*15	12
66	Screw	BT2.5*8	6
67	Screw	ST3.0*10	25
68	Screw	BT4*8	2
69	Screw	BT4*15	15
70	Nut	M5	6







NO.	DESCRIPTION	SPEC.	QTY
71	Nut	M6	2
72	Nut	M8	9
73	Nut	M10	2
74	Screw	M8*15	4
75	Screw	M6*12 nickel-chrome	14
76	Screw	M6*15 half-thread nickel-chrome	2
77	Screw	M6*50	1
78	Screw	M6*60	2
79	Screw	M8*12	2
80	Bolt	M10*45 10.9 grade screw length 15mm	1
81	Bolt	M10*60 10.9 grade screw length 15mm	1
82	Screw	M2*5	6
83	Screw	M4*8	16
84	Washer	Φ5*12*1.2	6
85	Flat Washer	Φ9*Φ16*T1.6	4
86	Washer	Φ6.6*Φ11.8*T1.6 nickel-plating	13
87	Flat Washer	Φ11*Φ20*T2.0	2
88	Washer	Φ4.1*Φ4.4*T1 nickel-plating	2
89	Spring Washer	M8	7
90	E-shape Snap Ring	Φ8 black	1
91	C-shape Snap Ring	match Φ20 black shaft	2
92	Flange Nut	M10*P1.25	2
93	Flat Washer	Φ12.2*Φ17*T0.5	4
94	O Shaped Ring	inner Φ13 wire Φ1.5	2

NO.	DESCRIPTION	SPEC.	QTY
95	Running Board Baffle		2
96	Power Cord		1
97	End Socket		1
98	Power Switch		1
99	Overload Protector		1
100	DC Motor		1
101	Incline Motor		1
102	Loudspeaker		2
103	MP3 Line		1
104	Controller		1
105	Upper Wire		1
106	Screw	M4*12	4
107	Lower Wire		1
108	Meter		1
109	Incline Shortcut Key Seat		1
110	Washer	Φ20.5*Φ30*T2.0	2
111	Wave Washer	Φ20.5*Φ27*T0.4	2
112	Tablet Bracket Fixing Screw / L		1
113	Tablet Bracket Fixed Screw / R		1
114	Handrail		2
115	Foot Lever		1
116	Screw	M8*35	1
117	Screw	M4*12	4
118	Screw	M6*25	6

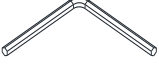
NO.	DESCRIPTION	SPEC.	QTY
119	Screw	BT2.2*5 nickel-plating	4
120	Speed Shortcut Key Seat		1
121	Pad Decorating Light		1
122	Loudspeaker Decorating Light		2
123	Incline Shortcut Key PC		1
124	Speed Shortcut Key PC		1
125	Pulse Outgoing Line		2
126	Shortcut Key Outgoing Wire		2
127	USB Module		1
128	Safety Key		1
129	Screw	M3*6	4
130	Single Wire	950mm	2
131	Single Wire	120mm	3
132	Grounding Wire	200mm	1
133	Pole Pressing Seat		2
134	Single-sided Adhesive		2
135 L/R	Anti-slip Sticker		2
136	Screw Cover		2
137	Plug		4
138	Safety Key Clip		2
139	Filter		1
140	Filter bracket		1
141	Single Grounding wire	1100mm	1
142	Single wire	400mm	2

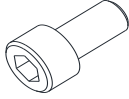
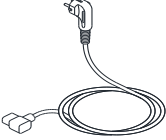
Tools & Hardware

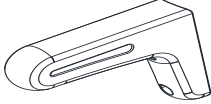
When you open the carton, you will find the below spare parts.

		
#20 Allen Wrench 1 PC	#103 MP3 Line 1 PC	#75 Screw M6*12 4 PCS
		
#96 Power Cord 1 PC	#55 Silicone Oil 1 PC	#114 Handrail 2 PCS
		
#128 Safety Key 1 PC		

Assembly Instructions

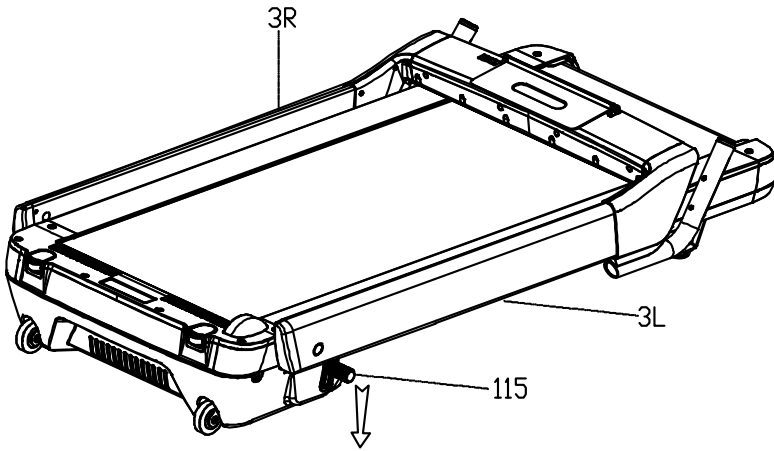

STEP 1:

Hold the **Handlebars (No. 3L & No. 3R)**. Press the **Foot Lever (No. 115)** until you hear a click, then raise the **Handlebars (No. 3L & No. 3R)** to a vertical position until you hear a click. Lightly shake the **Handlebars (No. 3L & No. 3R)** to make sure they are secure.

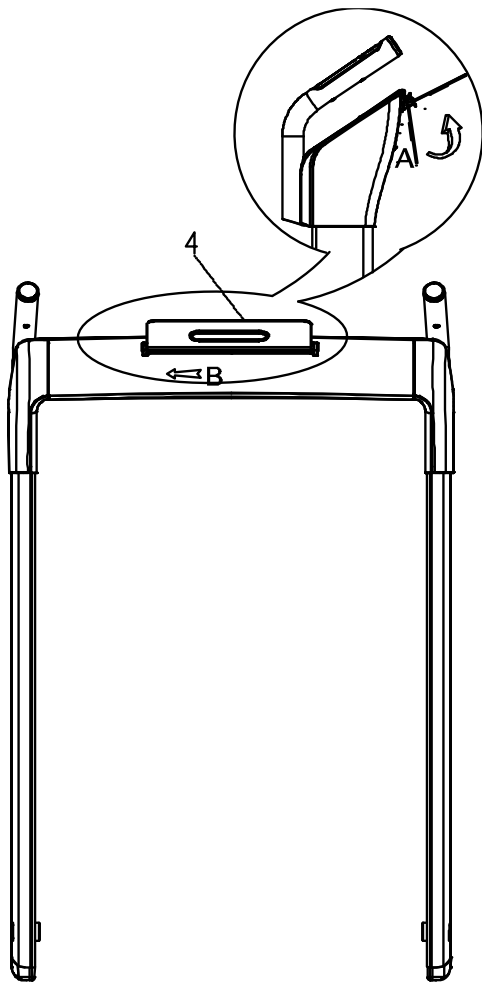

STEP 2:

Stand in front of the treadmill. Turn the **Tablet Bracket (No. 4)** upward as shown in drawing A, then pull it slightly to the left as shown in the drawing B to lock in position.

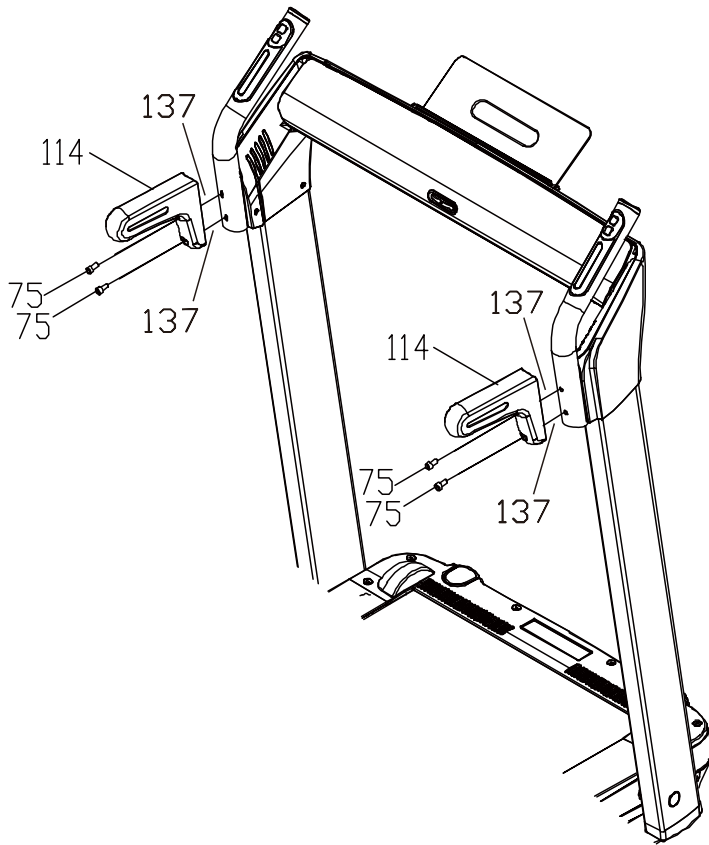

STEP 3:

Remove **Plugs (No. 137)**. Save the **Plugs (No. 137)** for later use when you remove the **Handrails (No. 114)**.

Attach the **Handrails (No. 114)** to the treadmill bracket with 4 **Screws (No. 75)**.

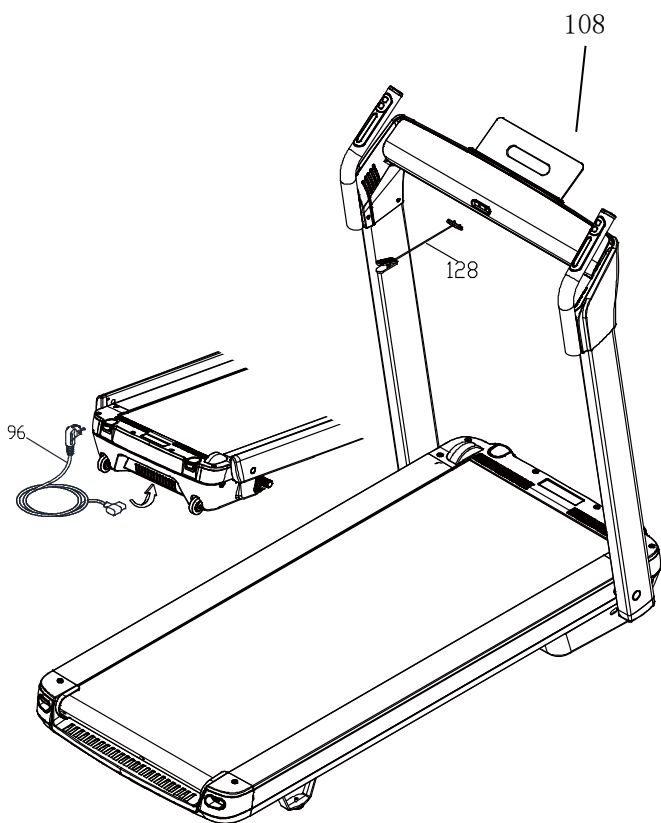

STEP 4:

Connect the **Power Cord (No. 96)** to the treadmill.

Insert the **Safety Key (No. 128)** into the **Meter (No. 108)**.

The assembly is complete!

Folding Instructions

Before you fold the treadmill, remove the 4 **Screws (No. 75)** and remove the **Handrails (No. 114)**.

If you saved the **Plugs (No. 137)**, you can plug in the holes.

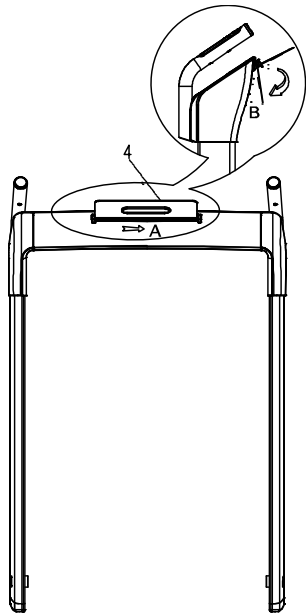
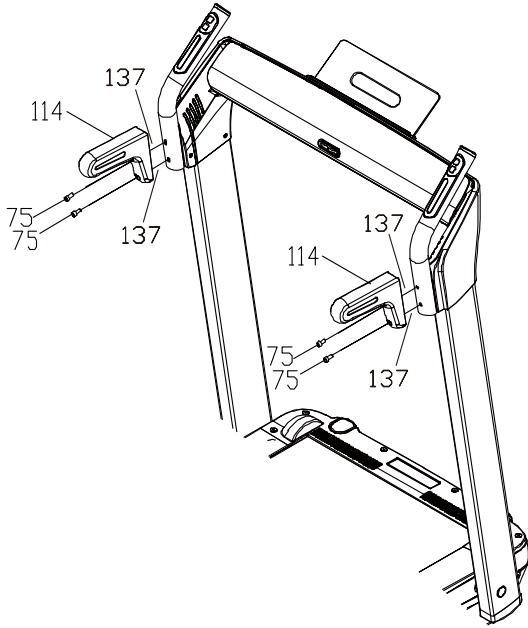

Stand in front of the treadmill. Fold the **Tablet Bracket (No. 4)** by pulling it to the right as shown in drawing A. Then, turn it down as in the drawing B.

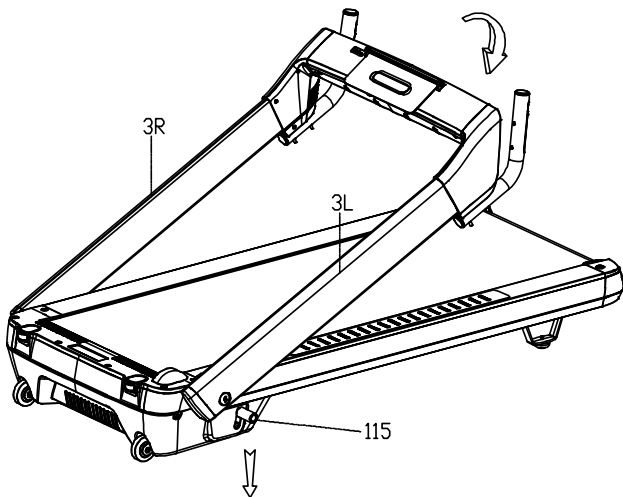

Hold the **Handlebars (No. 3L & No. 3R)**. Press the **Foot Lever (No. 115)** until you hear a click. Then, lower the **Handlebars (No. 3L & No. 3R)**.

Moving Instructions

Before moving the treadmill, fold the treadmill first. Pull out the supporting moving wheels according to the drawing, to ensure the folded treadmill is stable when standing upright.

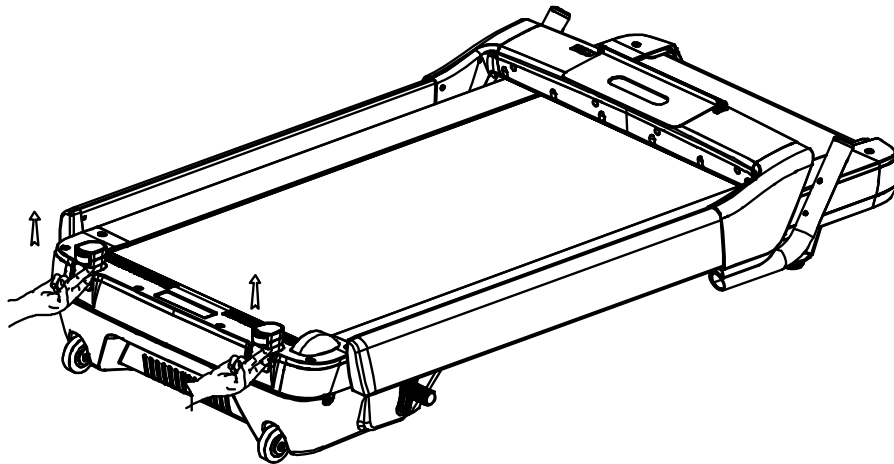

To store the treadmill upright, lift the treadmill so it stands vertically. To move the treadmill, tilt the treadmill towards you until the transportation wheels on the front base touch the ground. Then you can move the treadmill in front and back or left and right directions.

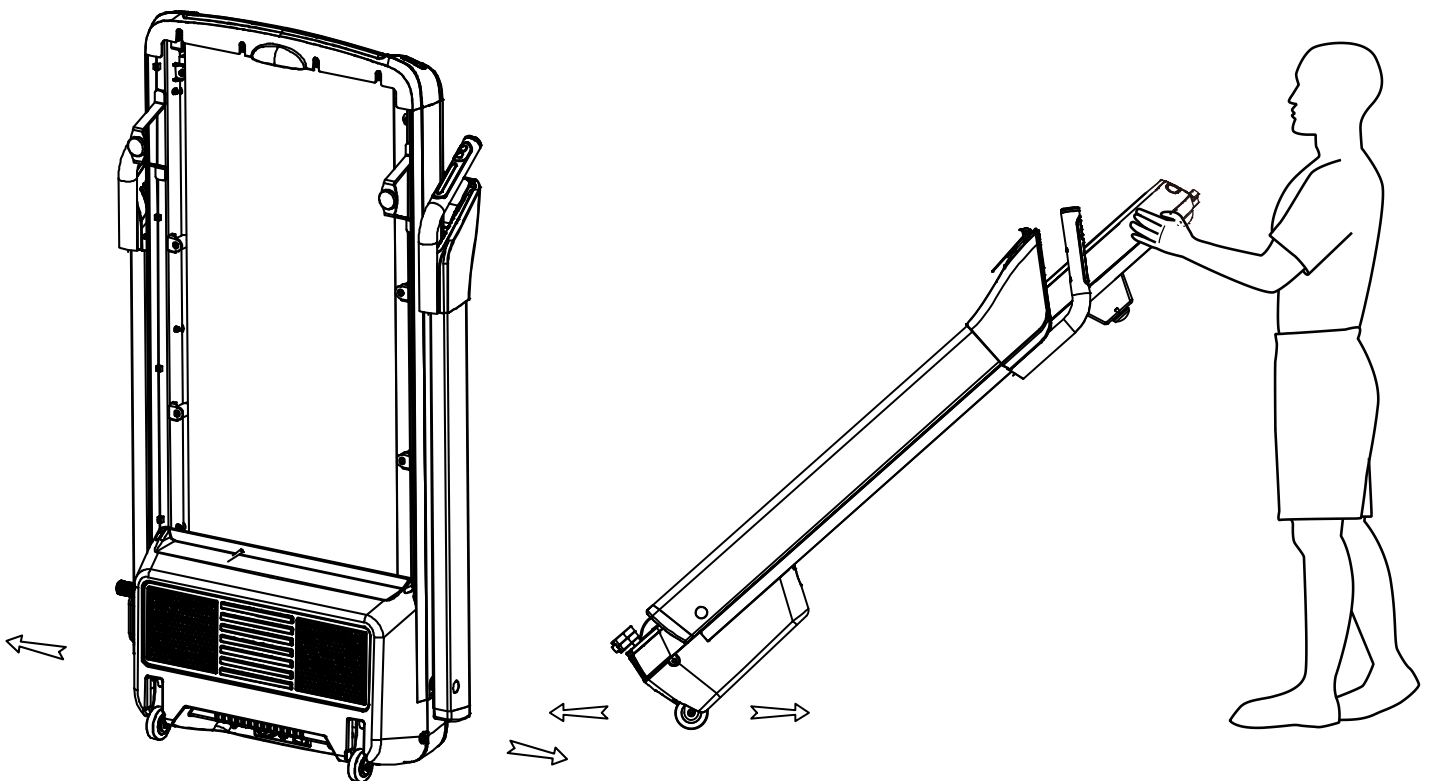

Specifications

Assembly Size (INCHES)	57.3(L)*29.3(W)* 48(H)	Speed Range (MI/H)	0.6—8.0
Folded Standing Size (INCHES)	29.3(L)*10.4(W)* 57.3(H)	Rating	930W
Running Size (INCHES)	51.2(L)*19(W)	Motor Spec (HP)	2.5HP(PEAK)
N.W. (LBS)	120	Input Volt (V)	110-120V
Max User Weight (LBS)	220	Operating Temperature	0-82°F
Incline	0-12%		
Blue Single Display	Speed, Time, Distance, Calories, Pulse, Incline, Step Count		

Important Electrical Information

WARNING:

This treadmill requires a power source of **10 amps (100-120V)** in order to properly operate. For your safety as well as the safety of others, please verify that the power source is correct before plugging in the equipment. Any power source above or below this level could cause significant damage to the equipment and/or user.

GROUNDING METHODS:

This product must be grounded. Grounding provides the least resistance for electrical current and will reduce the risk of electric shock. The plug must be plugged into an appropriate outlet that is properly installed and grounded in accordance with all local codes and ordinances. Ensure that the product is connected to an outlet which contains the same configuration as the plug. Do not use an adaptor for this product.

This product is for use on a nominal 100-120V circuit and has a grounding plug that looks like the plug illustrated in sketch A. Make sure that the product is connected to an outlet having the same configuration as the plug. No adapter should be used with this product.

DANGER:

Improper connection of the equipment-grounding conductor can result in risk of electric shock. Check with a certified electrician if you are in doubt as to whether the product is properly grounded. Do not modify the plug provided with the product. If it will not fit the outlet, have a proper outlet installed by an electrician.

WARNING!

1. NEVER use a ground fault circuit interrupt (GFCI) wall outlet with this treadmill. Route the power cord away from any moving part of the treadmill including the elevation mechanism and transport wheels.
2. NEVER operate the treadmill using a generator or UPS power supply.
3. NEVER remove any cover without first disconnecting AC power.
4. NEVER expose the treadmill to rain or moisture. This treadmill is not designed for use outdoors, near pools, or any other high humidity environment.

GROUNDING METHOD

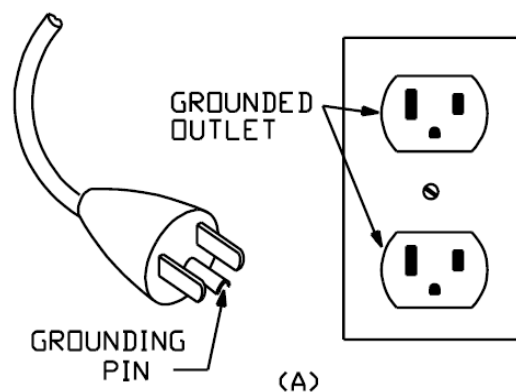

Operating Instructions

1. Plug the power cord into an outlet with appropriate voltage.
2. Turn on the power switch.
3. Insert the Safety Key.
4. Press the **START** button on the console.

Never start the treadmill while you are standing on the running belt. After connecting the power, there may be a pause after the running belt begins to move, you should always stand on the treadmill side plastic non-slip rails until the belt starts moving. Then step on to the belt.

SAFETY NOTE:

1. We recommend that you maintain a slow speed at the beginning and hold the handrails until you become familiar with the treadmill.
2. Insert the magnet end of the **Safety Key (No. 128)** into the computer console and attach the opposite end (containing the safety clip on it) to your clothing before starting your workout. To end your workout, press the STOP button or remove the **Safety Key (No. 128)** and the treadmill will stop immediately.







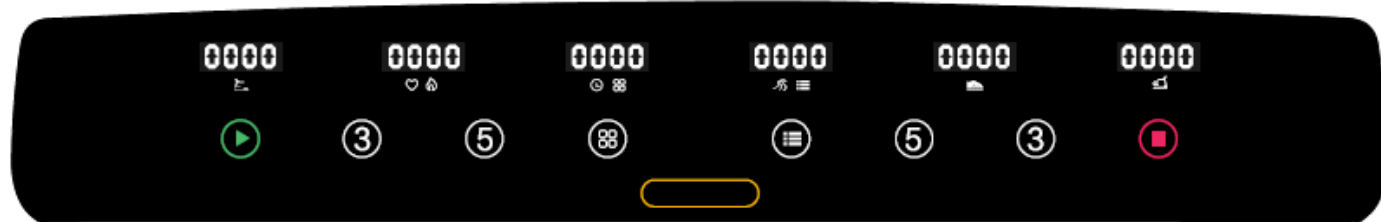

SAFETY KEY FUNCTION:

Removing the **Safety Key (No. 128)** from the computer console while the treadmill is running will cause it to stop immediately.









Display Console









Windows Display:

- a.  **Incline:** Displays current incline value.
- b.  **Pulse/**  **Calorie:** Displays current pulse value and the calories burned.
- c.  **Time/**  **Program:** Displays current exercise time and the current program.
- d.  **Distance/**  **Mode:** Displays current exercise distance and current mode.
- e.  **Pedometer:** Displays current steps value. Number of steps and number of turns will display alternately when number of steps is over 10,000; one turn equals to 10,000 steps.
- f.  **Speed:** Displays current exercise speed.

Key Functions:

- a.  **Start:** When the power is on and safety key is on, press this button to start the treadmill.
- b.  **Incline 3:** Set incline at Level 3.
- c.  **Incline 5:** Set incline at Level 5.
- d.  **Program:** In standby mode, press this button to scroll through programs: 0:00, P1-P2-...P8, U1-U2-U3. (0:00 is manual mode, P1-P8 is built-in program, U1-U3 is user program.) Manual mode is the system default operation mode. Manual mode default speed is 0.6 MI/H.
- e.  **Mode:** Press to scroll through the functions: 0:00, 30:00, 3.1, 100. (0:00 is manual mode, 30:00 is time countdown mode, 3.1 is distance countdown mode, 100 is calorie countdown mode.) When choosing different modes, use handrail speed + and - button to set corresponding countdown value. After setting the value, press  **Start** to start treadmill.
- f.  **Speed 3:** To set the speed at 3 MPH.
- g.  **Speed 5:** To set the speed at 5 MPH.
- h.  **Stop:** To stop the treadmill.

Instant Start:

- a. Turn on the power. Insert the safety key in the meter.
- b. Press  **Start**, system enters into 3 second countdown and the treadmill makes a beeping sound.  **Time**/ **Program** window displays the countdown numbers at the same time. After the 3 second countdown, the treadmill starts at 0.6 MI/H speed.
- c. After starting, adjust the treadmill speed and incline using handrail buttons. You can use  **Incline 3**,  **Incline 5**,  **Speed 3**,  **Speed 5** to adjust the speed and incline to preset levels.

During the Exercise:

- a. Use +/- right handrail buttons to increase/decrease speed. (0.1MI/H increments)
- b. Use +/- left handrail buttons to increase/decrease incline.

The graphics of the inclination level (0-12) and height

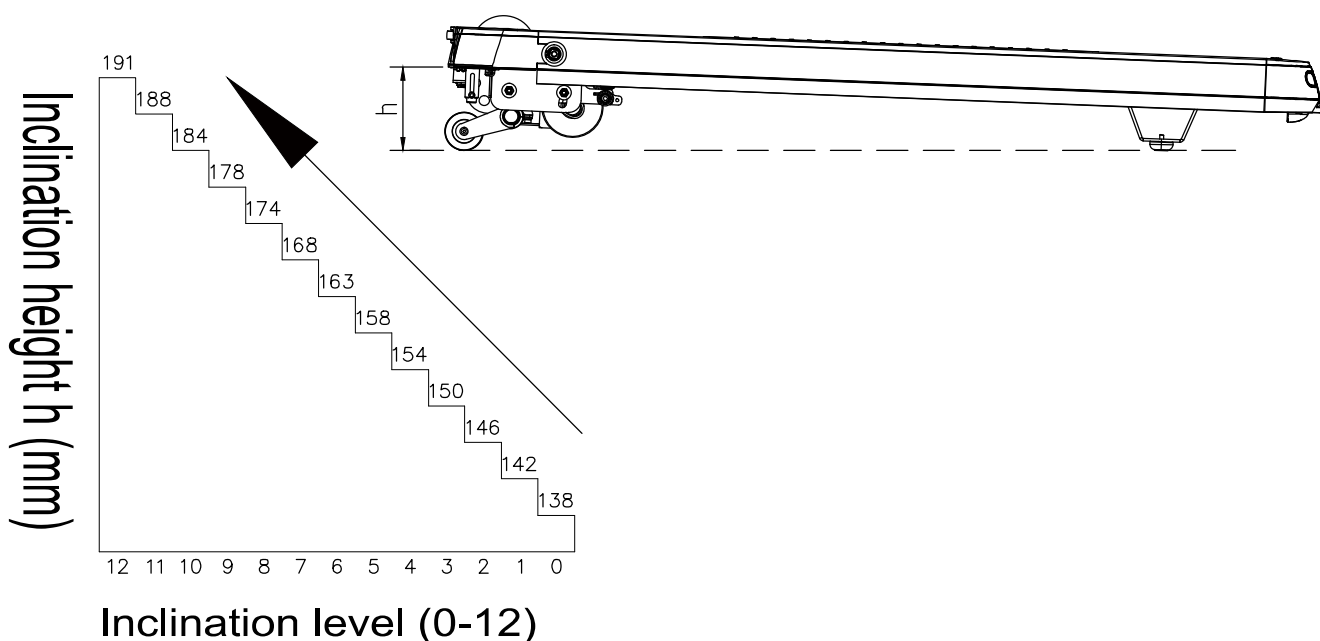



- c. Press the stop button to make the treadmill slow down to a stop.
- d. To measure pulse, hold the pulse sensors for 5 seconds, and the pulse icon will light up.

 **Pulse**/ **Calorie** displays the pulse data.

Manual Mode:

a. In standby mode, press  **Start**, and the treadmill starts at 0.6 MI/H speed and 0% incline.



b. In standby mode, press  **Mode**, to enter time countdown.



 **Time**/ **Program** window displays “30:00” and flashes and the time icon will light up. Press the handrail buttons on either side to set exercise time: setting range is: 5:00-99:00.

c. At time countdown mode, pressing  **Mode** enters the distance countdown mode. 

Distance/ **Mode** window displays “3.1” and flashes, then the distance icon will light up. Press the handrail buttons on either side to set exercise distance: distance setting range is: 0.6-61.9.



d. At the distance countdown mode, pressing  **Mode** enters into calorie countdown mode,

 **Pulse**/ **Calorie** window display “100” and flashes, then the calorie light turns on. Press the handrail buttons on either side to set calorie: calorie setting range is: 20-990.

e. After setting one of the modes to countdown, press  **Start**, the treadmill will start to run after 3 seconds. When the countdown is finished, the treadmill will stop. You can also press  **Stop** to stop directly.

Built-in Automatic Programs:

This system has 8 built-in automatic programs P1 to P8, in the standby mode. Press 

Program,  **Time**/ **Program** window to display “P1” to “P8”, and the program light

turns on.  **Time**/ **Program** window flashes at the same time. Time light will turn on

and display preset time “30:00”, after pressing both sides of the handrail+- to set the exercise

time, press  **Start** to start the built-in program. The built-in program is divided into 10

segments: each program exercise time=set time/10. When you enter into the next segment, if

speed or incline is going to change, the system beeps three times. The system speed and

incline will change when the program segment changes. You can press the handrail buttons

to change the speed and incline during each segment. When the program enters the next

segment, it will go to the speed and incline of this segment. When the segment of the

program is finished, the system will beep three times, and the treadmill slow down steadily to



a stop.

PROGRAM \ TIME		1	2	3	4	5	6	7	8	9	10
P1	speed	0.6	2.5	1.9	2.5	1.9	3.1	2.5	1.3	3.1	1.9
	incline	1	2	3	3	1	2	2	3	2	2
P2	speed	0.6	3.1	2.5	3.8	2.5	3.8	2.5	1.3	2.5	1.3
	incline	1	2	3	3	2	2	3	4	2	2
P3	speed	0.6	3.1	2.5	3.1	2.5	3.1	2.5	1.3	1.9	1.3
	incline	1	2	2	3	1	2	2	2	2	1
P4	speed	0.6	3.8	4.4	3.1	5	3.1	5.6	3.8	2.5	1.9
	incline	2	2	3	3	2	2	4	6	2	2
P5	speed	0.6	3.8	4.4	3.1	5	3.8	4.4	3.8	2.5	1.9
	incline	1	2	4	3	2	2	4	5	2	1
P6	speed	0.6	5	3.8	2.5	3.1	5.6	4.4	3.1	2.5	1.9
	incline	2	2	6	2	3	4	2	2	2	1
P7	speed	0.6	3.8	4.4	2.5	2.5	4.4	2.5	1.3	2.5	1.3
	incline	4	5	6	6	9	9	10	12	6	3
P8	speed	0.6	2.5	3.8	5	4.4	5	3.8	1.3	1.9	1.3
	incline	3	5	4	4	3	4	4	3	3	2



User Customized Program

Beside from 8 built-in programs, there are also 3 user customized programs that allow users to set according to personal preferences: U1, U2, U3.

a. The setting of user customized program:

At the standby mode, press and hold  **Program** to set the user customized program (U1-U3). Press  **Mode** to confirm and enter setting, then set the first period. Use handrail speed button to set speed and use handrail incline button to set incline. Press  **Mode**, finish the first time setting and enter into the second time setting until finishing all 10 periods' setting. After finishing the settings, the data will be saved permanently until the next time. The data will not be lost because of a power outage.

b. Using user customized program.

- (1). Press  **Program** continually at the standby mode until you get to the user customized program (U1-U3), then set the operation time and press  **Start** to start.
- (2). After setting a user customized program and operation time, press  **Start** to start.

c. The user customized program setting instruction.

Every program divides the time into 10 segments. You will need to set the speed, incline, and time of the 10 segments before pressing the start button to start the treadmill.



Audio:

When the power is on, you can connect the MP3 wire to audio device to play music. When the treadmill powers down and enters sleep mode, the music will stop. Pressing any key will reactivate the treadmill.

USB Interface:

USB connection can only charge your device. It cannot be used to play music.

Metric/Imperial Unit Change:

Remove the safety key. Press and hold  **Start** button, then reconnect the safety key. Keep holding the  **Start** until all the display functions light up then release. Press either side of the handrail buttons to select Metric or Imperial system ("SI" signifies Metric system and "Eng" signifies Imperial system). After selecting, press the  **Start** button to confirm and return to standby mode.

Safety Key Function:

In any mode, pulling off the safety key can stop the treadmill from running immediately. When the treadmill stops immediately, the treadmill will make a beeping noise and the display panel displays "SAFE". At this moment, you cannot operate the treadmill except to turn it off. Insert the safety lock again and the treadmill will be in standby mode.

Incline Self-Adjustment:

At the standby state, press  **Stop** and  **Speed 5** to do a self-adjustment. After adjusting, you can return to standby state.

Power Saving Mode:

This system has power saving function in the standby mode. If there is no button command input within 4 minutes, the system will enter power saving mode and shut off the display automatically. Press any button to turn on the system.

Treadmill Error Codes:

If the treadmill displays error code, please contact Customer Service at support@sunnyhealthfitness.com.

Er1: Display panel couldn't receive the signal.

Er3: Over voltage.

Er4: IGBT short circuit (Over current).

Er5: Over load.

Er6: The motor is not connected, (only direct current).

Er7: The controller couldn't receive the signal.

Er8: Preventing reversing switch action.

Er13: Over current.

Er14: Over-loading; short-circuit.

A. Shutdown:

You can turn off the power to shut down the treadmill in any mode. This will not damage the treadmill.

B. Attention:

1. Check the power, safety key, and that the treadmill is in a valid mode before starting to exercise.
2. When encountering an emergency, pull off the safety key to stop the treadmill quickly. When you put the safety key back in, the system goes back to default and you can use the treadmill.

Maintenance Instructions

Cleaning

Please make sure the treadmill's power plug is unplugged before cleaning the machine. Keep the treadmill clean by dusting it regularly. Be sure to clean the exposed parts on both sides of the running belt. This can reduce the dust underneath. Make sure your shoes are clean to avoid any foreign material damaging the running belt and running board. The top of the belt needs to be cleaned with a wet, soapy cloth. Be careful and keep all liquids away from the electrical components and underneath the running belt.

WARNING

Remember to unplug the treadmill from the electrical outlet before removing the motor cover. Remove the motor cover and vacuum underneath at least once a year.

Running belt and the lubricant oil of the motorized treadmill:

This treadmill's running belt and board are already pre-lubricated. The belt/board friction may play a major role in the function and life of your treadmill, thus requiring periodic lubrication. We recommend a periodic inspection of the running board. If the running board is worn out, please contact our client service center.

We suggest you buy lubricant from local distributors or contact our company directly.

1. In order to maintain and prolong the life of your treadmill, we suggest you power it off for 10 minutes every 2 hours of use.
2. A loose running belt will slip off when running. The tightness of the running belt will affect the performance of the motor. The perfect state is when the running belt can be lifted from the running board about 50-75mm.

Adjusting Belt Centering and Tightness:

- a. If the **Running Belt (No. 25)** doesn't stop when you press it, the **Running Belt (No. 25)** and motor belt is positioned correctly.
- b. If the **Running Belt (No. 25)** stops when you press it, but the motor belt and the front roller don't stop, the **Running Belt (No. 25)** is loose. Adjust the **Running Belt (No. 25)** for safe use.
- c. If the **Running Belt (No. 25)** and motor belt stop when pressing the **Running Belt (No. 25)** and the motor still runs, the motor belt needs to be adjusted for the safe use.

It is necessary to adjust the **Running Belt (No. 25)** to the best condition for the better use of the treadmill.

1. Put the motorized treadmill on level ground. Let the treadmill run at the speed of 6-8 M/H, observe the **Running Belt (No. 25)** deviating condition.
2. If the **Running Belt (No. 25)** deviates to the right, pull off the **Safety Key (No. 128)** and unplug the power. Turn the right side adjusting bolt clockwise by 1/4 circle. Turn on the treadmill and watch the **Running Belt (No. 25)** to see if it is centered. Repeat the above steps, until the **Running Belt (No. 25)** is in the middle. Please refer to figure A.
3. If the **Running Belt (No. 25)** deviates to the left, pull off the **Safety Key (No. 128)**, unplug the power, turn the left adjusting bolt clockwise by 1/4 circle. Turn on the treadmill and watch the **Running Belt (No. 25)** to see if it is centered. Repeat the above steps, until the **Running Belt (No. 25)** goes to the middle. Please refer to figure B.
4. After the above adjustment or after multiple uses, **Running Belt (No. 25)** may become loose and needs adjustments. Pull off the **Safety Key (No. 128)**, turn off the power switch, and turn the left and right adjusting bolt clockwise by 1/4 circle. Turn on the treadmill, then stand on the treadmill to confirm the tightness of the **Running Belt (No. 25)**. Repeat above steps, until the **Running Belt (No. 25)** is moderate in tightness. Please refer to figure C.

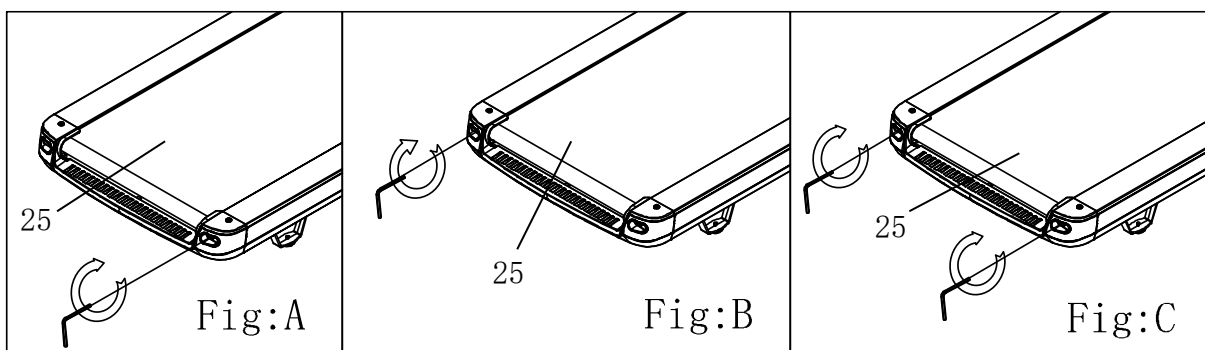

*IMPORTANT NOTE:

This treadmill does come pre-lubricated, but it is recommended to lubricate your treadmill before the first use.

RUNNING BELTS & TREADMILL LUBRICANT:

Lubricating the **Running Board (No. 24)** and **Running Belt (No. 25)** is essential as the friction between the two affects the life span and function of the treadmill. It is suggested that the **Running Board (No. 24)** and **Running Belt (No. 25)** be inspected regularly. Should you find any wear on the **Running Board (No. 24)**, please contact us at: support@sunnyhealthfitness.com.

WARNING:

Always unplug the treadmill from the electrical outlet before cleaning, lubricating, or repairing the unit.

HOW TO LUBRICATE:

Raise the **Running Belt (No. 25)** up on one side and apply lubricant to the **Running Board (No. 24)**. Use a rag to thoroughly wipe the lubricant over the **Running Board (No. 24)**. Repeat this process for the other side. The moving parts should turn freely and quietly. Abnormal moving parts will affect the safety of the equipment. Inspect and tighten bolts regularly.

To better maintain the treadmill and prolong its lifespan, it is suggested that maintenance be done on a regular basis. **DO NOT LOOSEN OR MAKE ANY ADJUSTMENTS TO THE RUNNING BELT WHILE APPLYING LUBRICANT.** A loose **Running Belt (No. 25)** will result in the runner sliding off during use, while too tight of a **Running Belt (No. 25)** will negatively affect the motor's performance and create more friction between the roller and **Running Belt (No. 25)**. The most suitable tightness for the **Running Belt (No. 25)** is when it is pulled out 50-75mm from the **Running Board (No. 24)**.

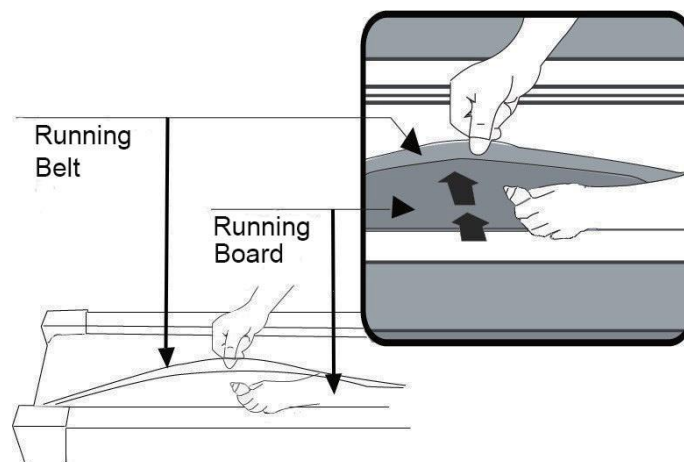

The following time table is recommended:

Light user (less than 3 hours/week)	every six months
Medium user (3-5 hours/week)	every three months
Heavy user (more than 5 hours/week)	every two months