

NINJA TOTAL

QUICK-START GUIDE



CONTENTS	I	PAGE #
Machine Registration		1
Installing Safety Shield		2
Powering Machine ON/OFF		3
Login/Password Entry		4
Important Machine Notices		5
Cut by Decode High Security		6-7
Cut by Code High Security		8-9
Using Ford AV12 Adaptor		10
Cut by Decode Dimple		11-13
Cut by Code Dimple		14-15
Cut by Decode Edge Cut		16-17
Cut by Code Edge Cut		18-19
Cutter Replacement		20-21
Tracer Replacement		22
Software Update Via Ethernet		23-25
Software Update Via USB		26-30
Favorites		31
Spare Parts List		32

**Watch the Ninja Total
Training Course for Free!**

www.keylineacademy.com



Where Customers Become Experts

*** IMPORTANT ***

REGISTERING YOUR MACHINE

Thank you for your purchase of the Keyline Ninja Total.

Before continuing with machine setup and use, please complete the following;

REGISTER YOUR MACHINE ON THE WEB

Visit **Customer Area** on www.keyline-usa.com then select the **Registration** section. Complete the online form and register each machine you own with the respective serial numbers. Once complete your profile will be set up.

PLEASE NOTE: YOU MUST REGISTER YOUR MACHINE ONLINE TO HAVE ACCESS TO SOFTWARE UPDATES, MANUALS & QUICK START GUIDES.

Registration Link: https://keyline-usa.com/en_US/user-auth/register

Or visit www.keyline-usa.com and press the "Register" link under the login area

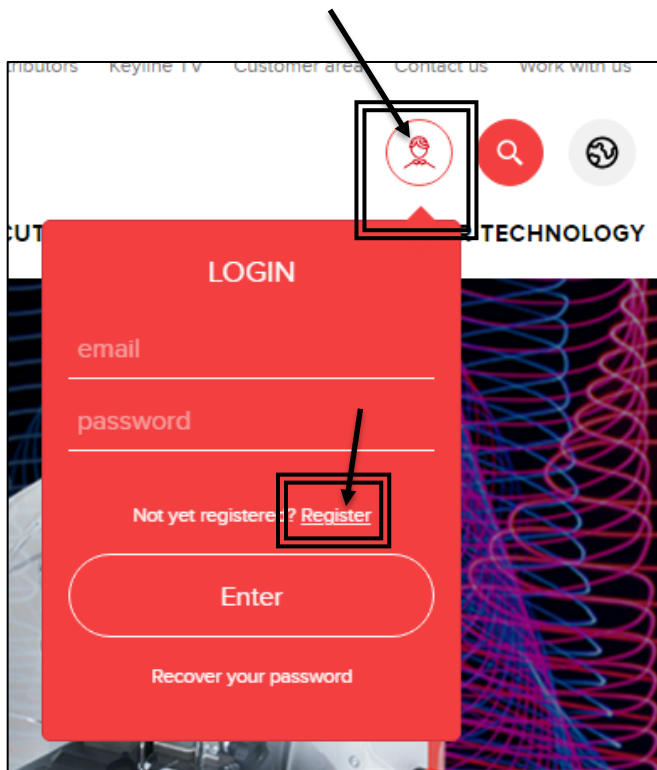

INSTALLING SAFETY SHIELD

Your Ninja Total safety shield is shipped separate from the machine in order to protect the shield in transit. Please follow the instructions for installing the shield upon receipt before initial use.



STEP 1:
Remove the Ninja Total and the shield from the box

Locate the 4mm allen wrench in the tool kit

STEP 2:
Remove the screws on each side of the Ninja Total and set aside



STEP 3:
Line up shield on machine so opening is directly over screw hole. Slots must be perpendicular to base.

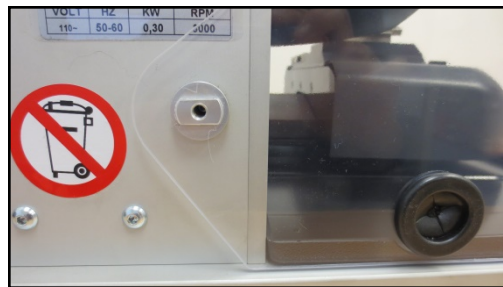

STEP 4:
Reinsert screws and tighten down with 4mm allen wrench on both sides. Machine is now ready for use.



POWERING MACHINE ON/OFF

Cable Connection & Powering Machine ON

***MOBILE USERS: YOU MUST USE A PURE SINE WAVE INVERTER WITH 2000 WATTS (or greater) TO POWER THE MACHINE OR MACHINE MOTOR WILL NOT WORK PROPERLY**

1. Attach the 9-pin connector cable to the port on the **LEFT SIDE** of the console **AND** to the back of the machine. **SECURE WITH ATTACHED SCREWS**. Also, connect the black cable to the console and the back of the machine.
2. Attach power cord to back of machine and plug into a properly grounded outlet.
3. Rotate the Emergency Stop button towards the back of the machine until it releases outward. The machine will now begin to start-up if the top ON/OFF button is pressed down.
4. Press down on the ON/OFF button which will illuminate to RED. **The boot up process can take up to 4 minutes**. Proceed with **LOGIN** (page 4).



Powering Machine OFF

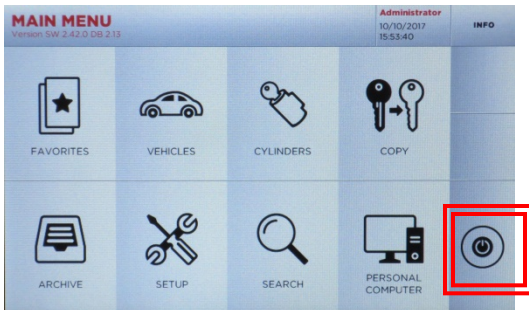

At **MAIN MENU**, select **Power** button

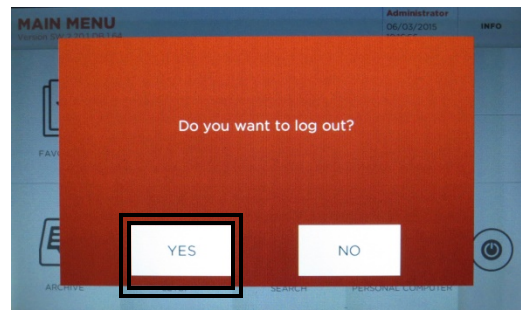

Select **YES** to log out, then select Power button again at Login screen

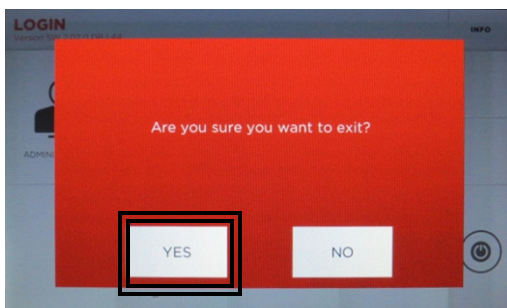

Select **YES** to exit



LOGIN / PASSWORD ENTRY

TIP: Use included stylus with touch screen to ensure accurate selections

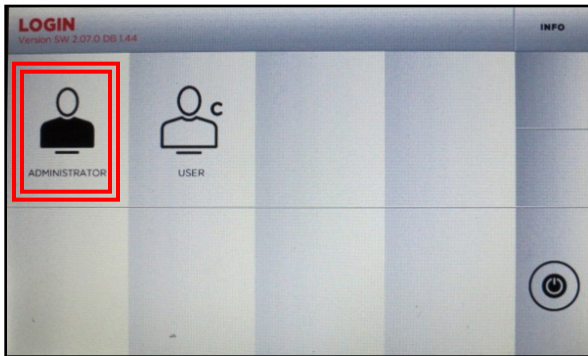

Select **ADMINISTRATOR**

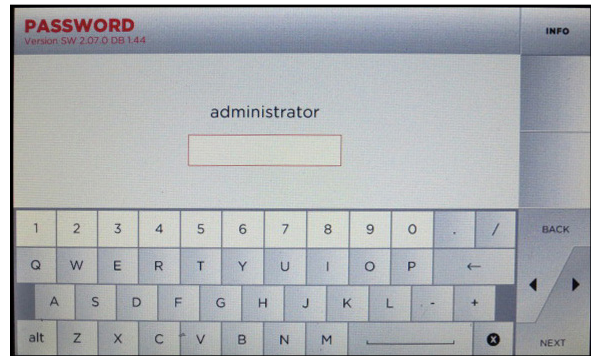

Leave password screen blank, no default password is set, Select **NEXT**. To create password, see below.

PASSWORD CREATION (OPTIONAL) -Skip this section if you do not want a password-

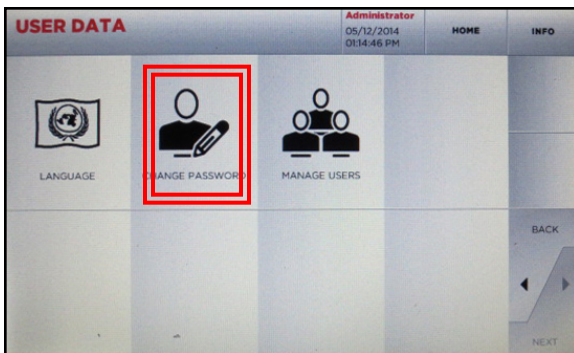
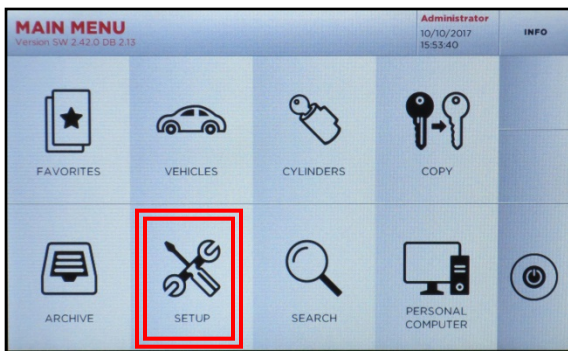

From Main Menu, Select **SETUP**, then **USERS** and then **CHANGE PASSWORD**. At the Change Password screen **enter in your new password and confirm** (leave Old Password line blank) then select **NEXT**. Administrator password is now set.

IMPORTANT

SAFETY SHIELD

The safety shield works in conjunction with the software prompts. The software, before starting some cut and decode procedures, requires the closing of the safety shield. If it is not closed when requested, it will continue to ask its closing. If the user opens the safety shield during an operating phase (for example, when the machine is cutting or decoding a key) it will stop immediately and, at the closing of the shield, the machine will reset the operation and go back to the beginning of the procedure. Make sure to complete all parts of the process at one time, then close the shield before proceeding to the next step. This will avoid having to replicate steps.

KEY MATERIAL

The Ninja Total defaults to cutting brass keys as the key material type. If you are cutting a different type of metal key, such as steel, nickel silver or aluminum, you can make the selection in the cutting screen. Please note the Ninja Total cannot cut or decode any type of plastic key, painted keys or keys made of non-conductive materials.

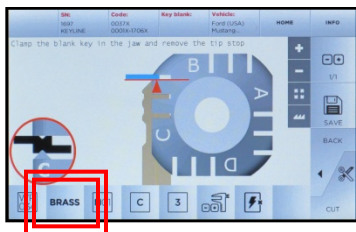

To change the material type, simply touch the BRASS icon on the screen until you reach the desired material; **BRASS**, **STEEL**, **NiSi** (Nickel Silver) or **ALU** (aluminum)

USE OF AFTERMARKET SPARE PARTS

Keyline machines require the use of factory original parts. Aftermarket cutters, tracers and adaptors are not recommended and may cause product damage that will void your machine warranty.

MACHINE PACKAGING

Please retain all machine packaging for transportation purposes. Packaging is specially designed to safely transport the machine and it's components. Keyline is not responsible for providing additional packing material if original boxes are lost, damaged or discarded.

WARRANTY INFORMATION

In Warranty (within 90 days of purchase): Customer will return machine and Keyline USA will the reimburse shipping charges. Keyline USA will pay the return shipping back to the customer

In Warranty (91+ days of purchase): Customer will pay to return the machine to Keyline USA. Keyline USA will pay the return shipping back to the customer

Out of Warranty: Customer will pay to return the machine to Keyline USA. Customer will pay the return shipping back to the customer

TEMPERATURE

Machine operating temperature is between 32 and 104 degrees Fahrenheit.

CUT BY DECODE – HIGH SECURITY

TIP: DO NOT DECODE PLASTIC KEYS! Only metal keys can be decoded and cut on the Ninja Total.

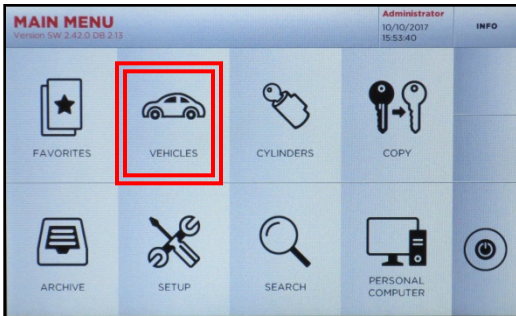

Select **VEHICLES**

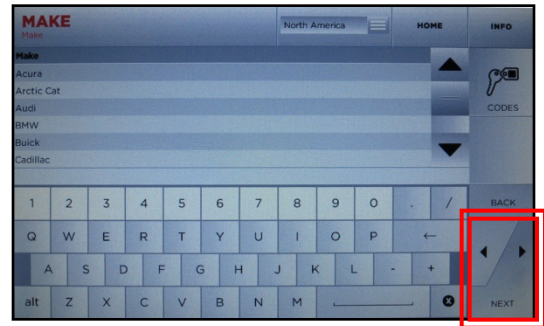

Select **MAKE**, then **NEXT**

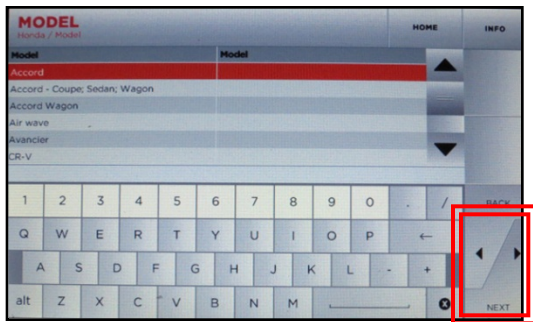

Select **MODEL**, then **NEXT**

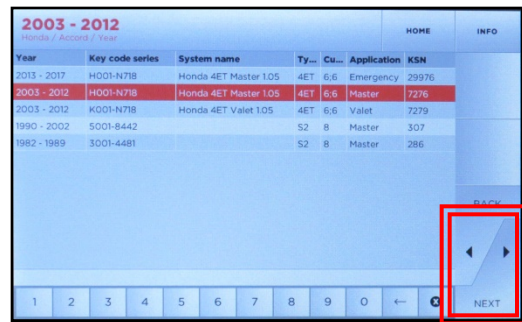

Select **YEAR RANGE**, then **NEXT**

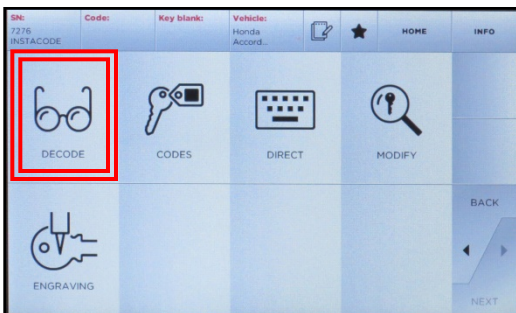

Select **DECODE**, then select **NEXT**

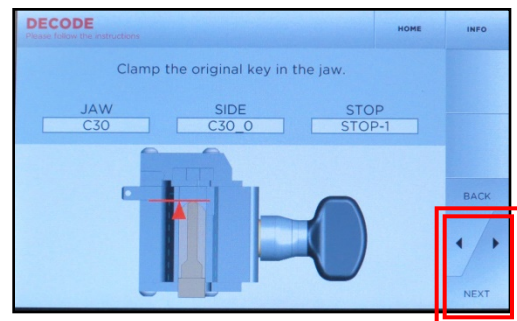

Insert key on jaw, clamp down jaw, remove tip stop and close shield, then select **NEXT**

CUT BY DECODE – H.S., cont.

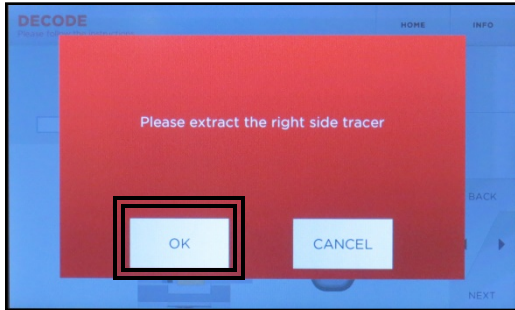

Extract the right side tracer, then select **OK**

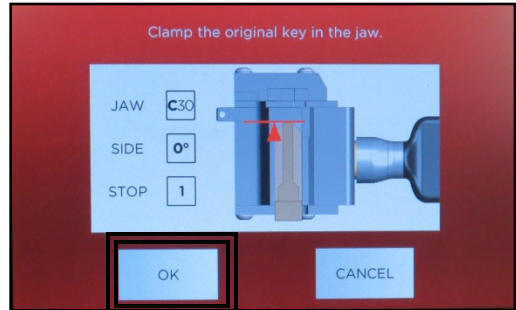

Confirm key is inserted correctly, then select **OK**

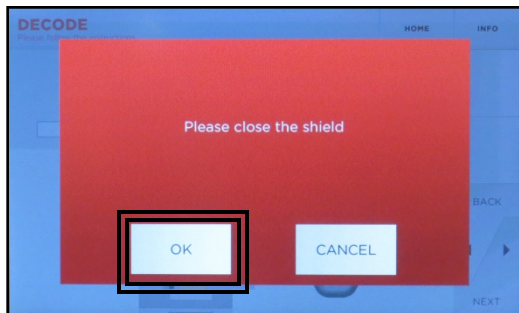

Close shield then select **OK**

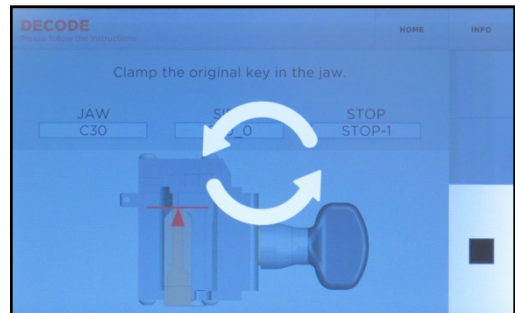

Decoding in process

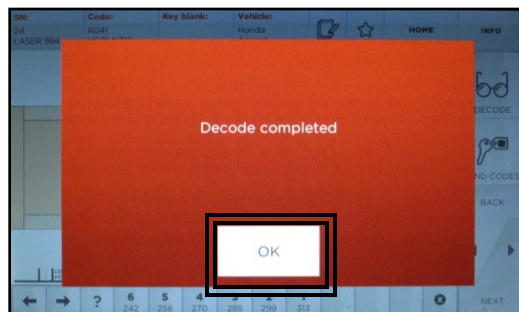

Decode complete; Select **OK**

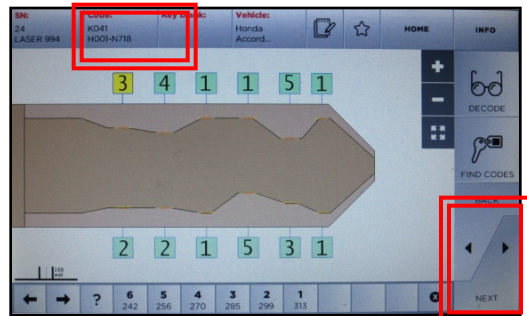

Depths and key code displayed

Select **NEXT**, then proceed with cutting the key by code (refer to Page 8 – CUT BY CODE-H.S., cont. to proceed with cutting)

CUT BY CODE – HIGH SECURITY

TIP: Cutting a test key is also recommended on first use to verify correct key cutting procedure.

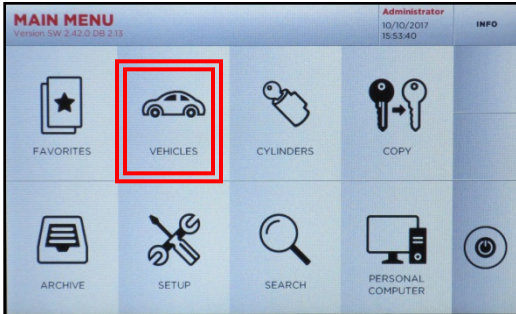

Select **CARS**

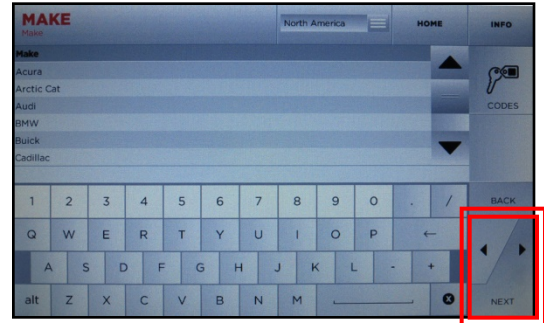

Select **MAKE**, then NEXT

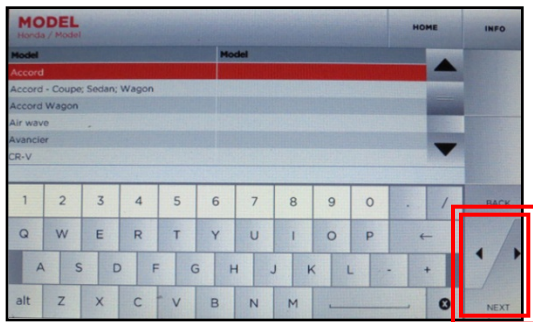

Select **MODEL**, then NEXT

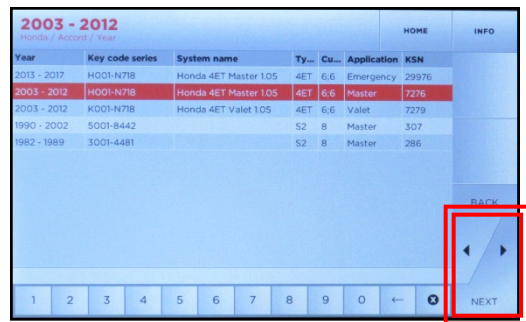

Select **YEAR RANGE**, then NEXT

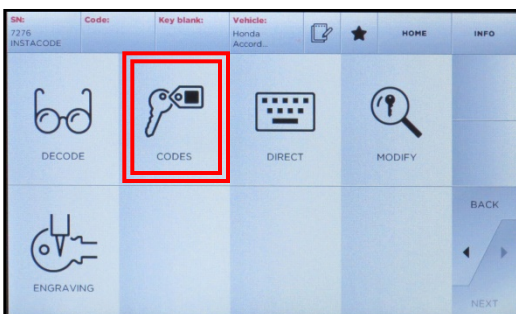

Select **CODES**, then select NEXT

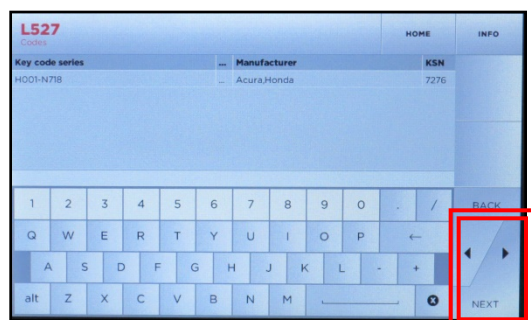

Enter code, (ex. L527), select NEXT

CUT BY CODE – HIGH SECURITY, cont.

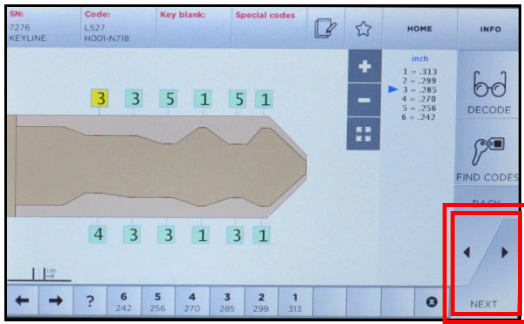

Key depths appear, select **NEXT**

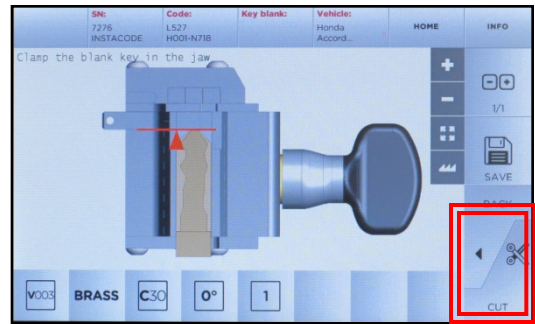

Insert key correctly on jaw as shown and lock down jaw. Then select **CUT**.

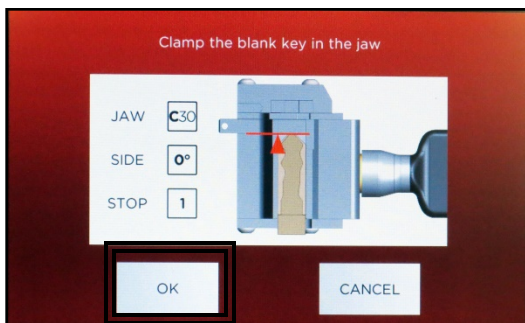

Select **OK**

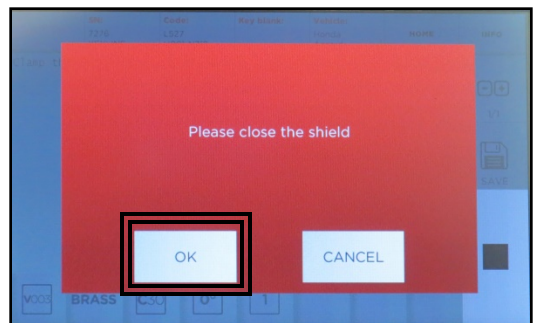

Close shield, then select **OK**

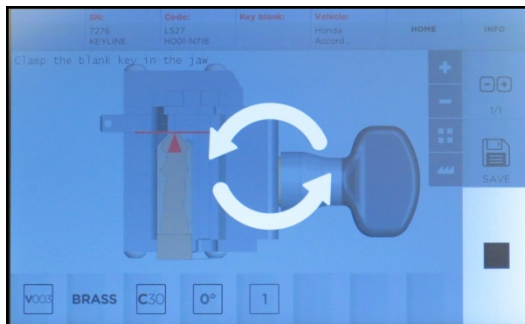

Key cutting begins

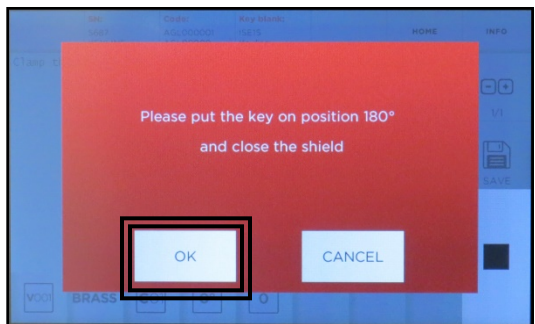

Rotate the key and tighten down jaw, close shield, then select **OK**

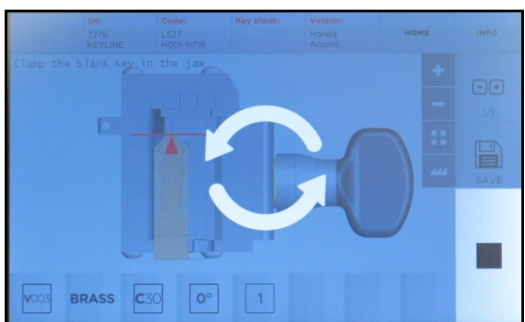

Key cutting begins

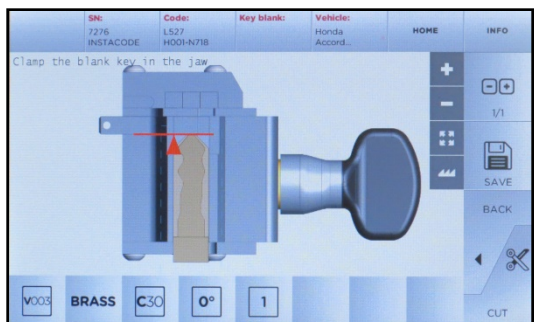

Select **CUT** to cut additional keys

USING FORD AV12 ADAPTOR

Follow steps for cutting by code or decode for high security keys and use adaptor when prompted. Instructions below for installation of AV12 adaptor which is required for certain Ford and Land Rover high security key blanks that use the FD40/HU101 keyway.

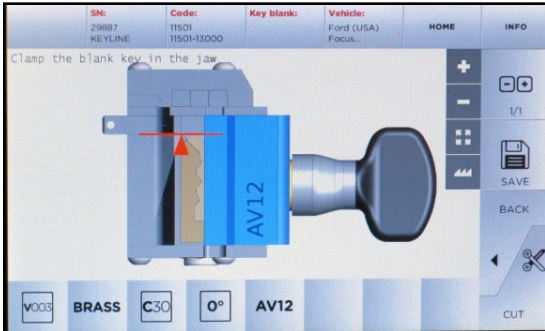

Screen shot will indicate when the AV12 adaptor is needed

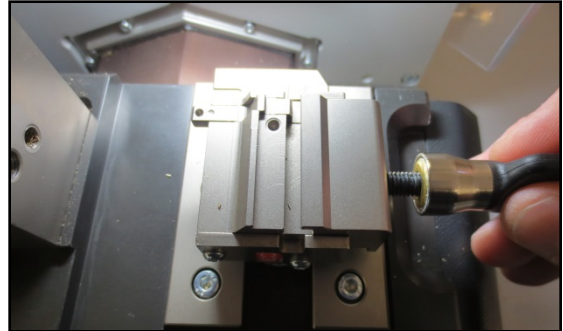

Remove the jaw handle

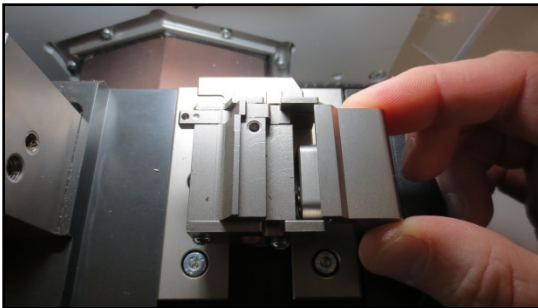

Remove the jaw plate

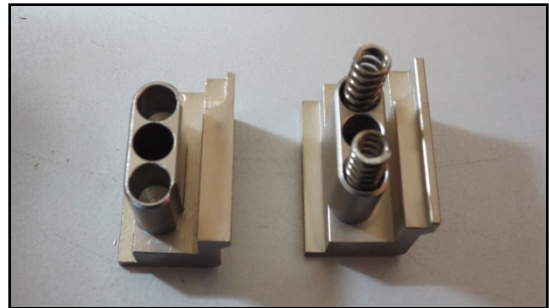

Set aside the original jaw plate (on left), remove the springs and insert onto AV12 adaptor (on right).

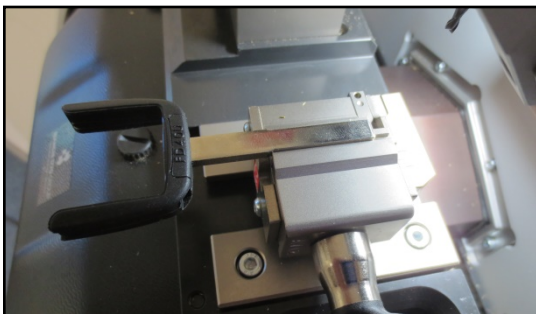

Install AV12 adaptor on jaw, tighten down jaw handle, then insert key

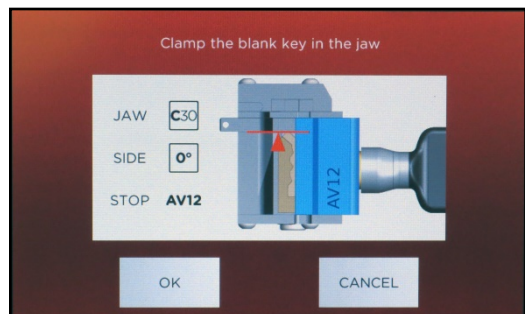

Confirm the key blank is correctly on the jaw and select OK

CUT BY DECODE – DIMPLE

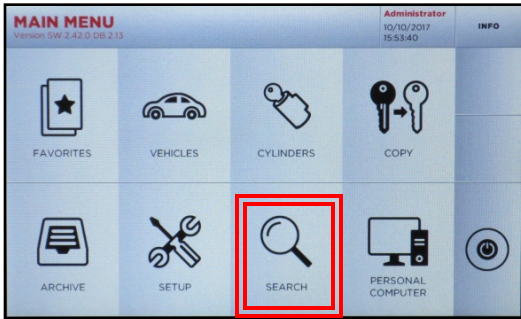

Select **SEARCH**

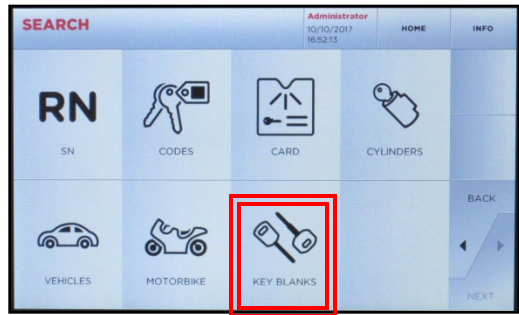

Select **KEY BLANKS**

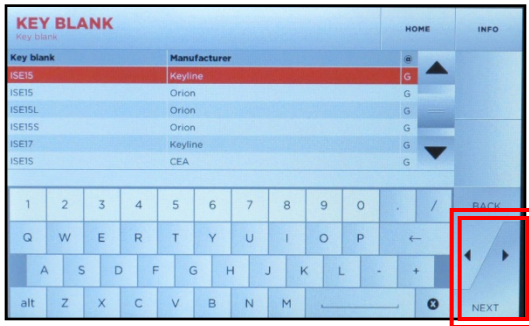

Select the key blank, then **NEXT**

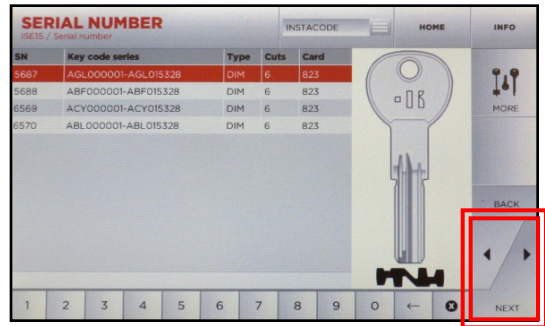

Select **SERIAL NUMBER**, then **NEXT**

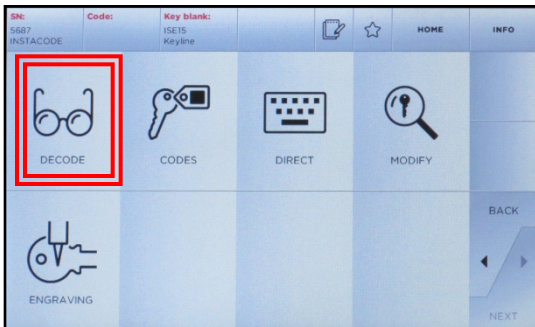

Select **DECODE**

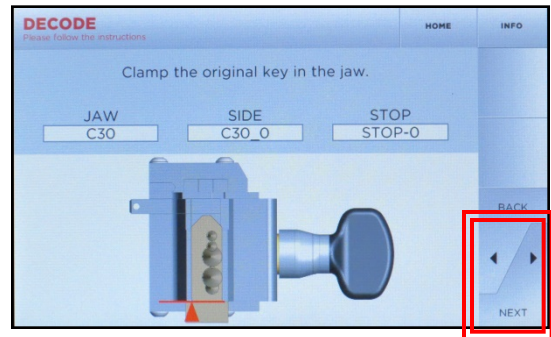

Only select **NEXT** to proceed

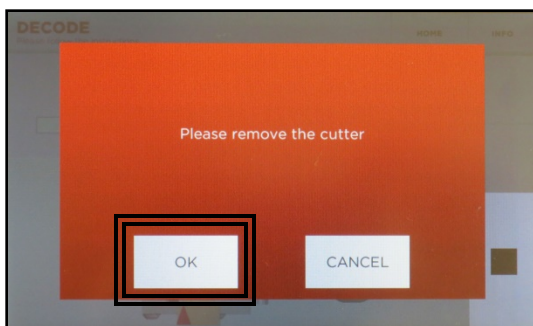

Remove current cutter installed, then select **OK**

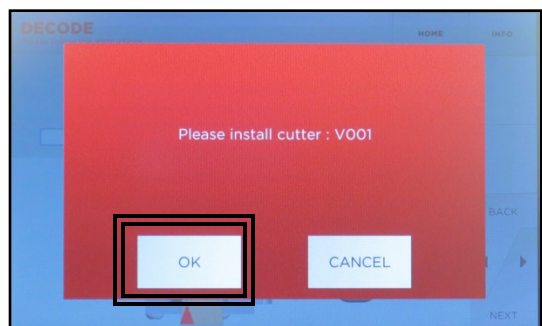

Install V001 cutter, then select **OK**

CUT BY DECODE – DIMPLE, cont.

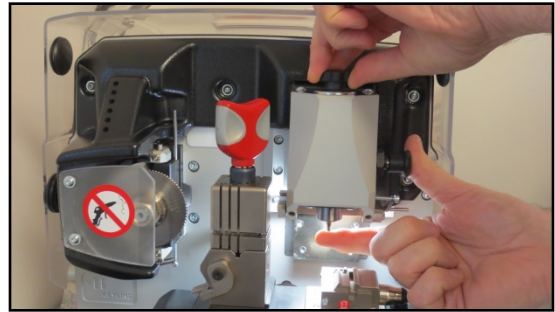
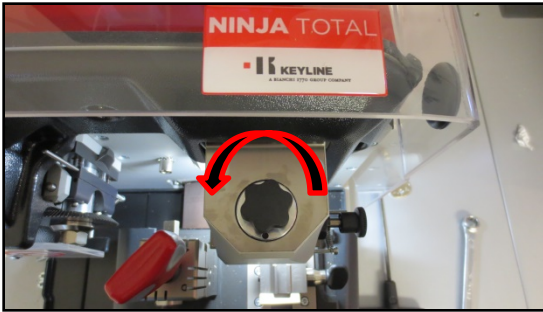

Remove the cutter by pushing in on the black knob on right, then rotate the black knob on the top ¼ turn counter-clockwise until the knob at right pushes in locking the spindle. Cutter will release to be removed.

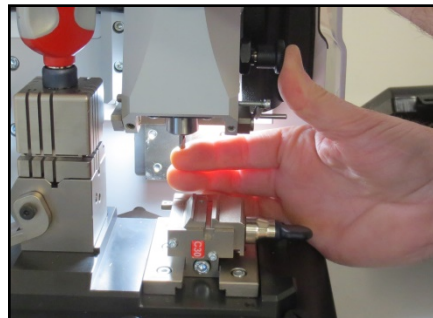
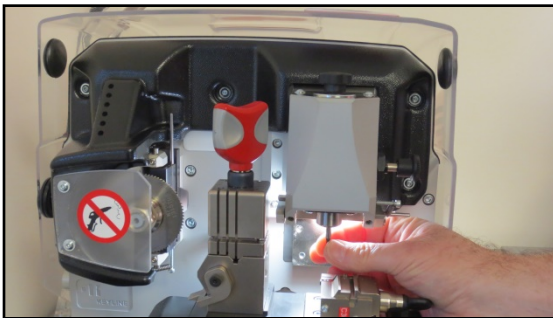

Remove the cutter, then install new cutter by inserting cutter into spindle while pressing in the black spring loaded button on the right

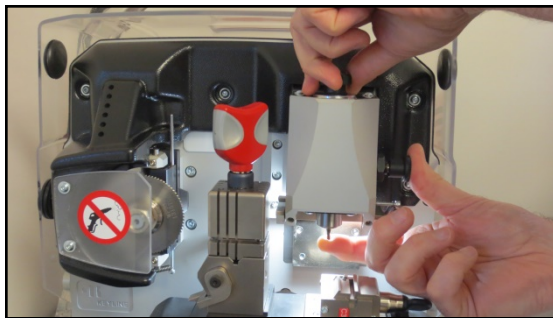

Tighten down black knob by rotating clockwise

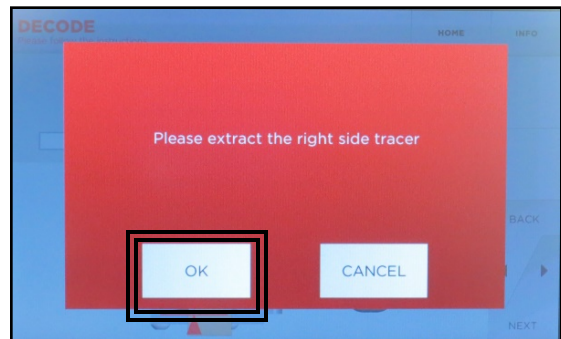
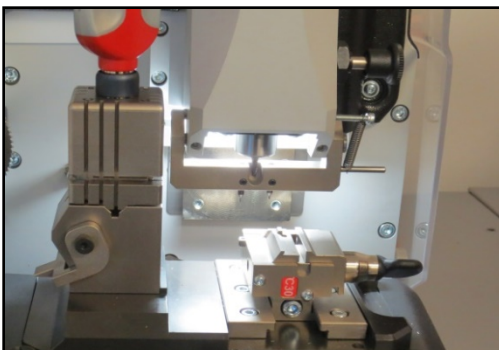

Extract tracer, then select **OK**

CUT BY DECODE – DIMPLE, cont.

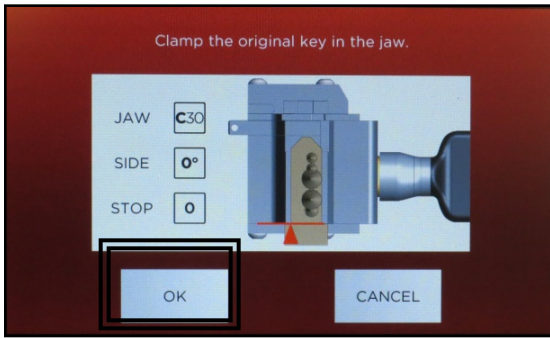

Clamp key on the jaw, then select **NEXT**

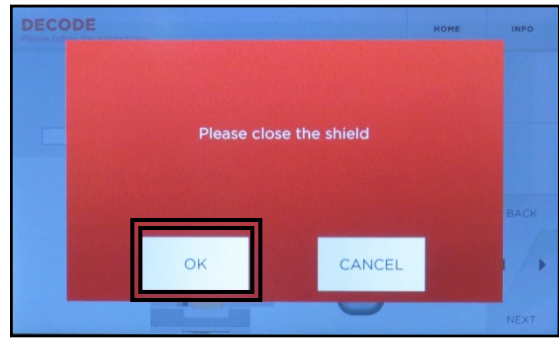

Close the shield, then select **OK**

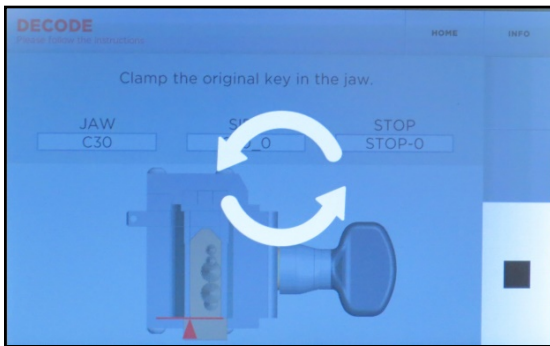

Decoding in process

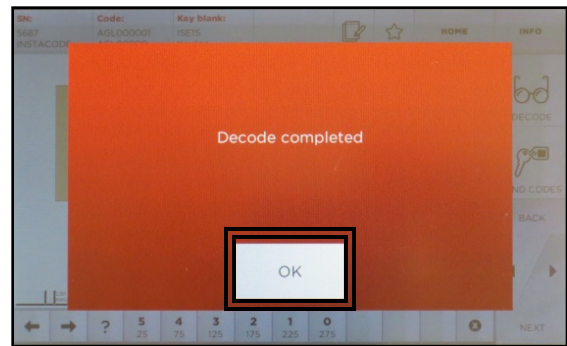

Decode complete; Select **OK**

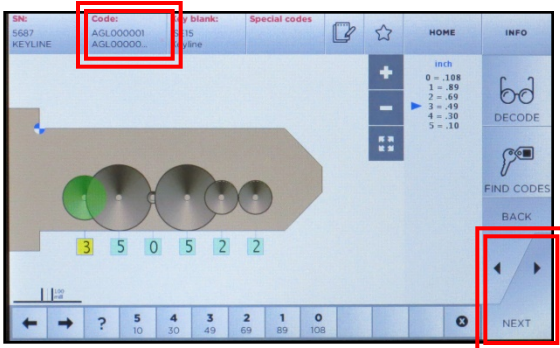

Code displayed, select **NEXT**

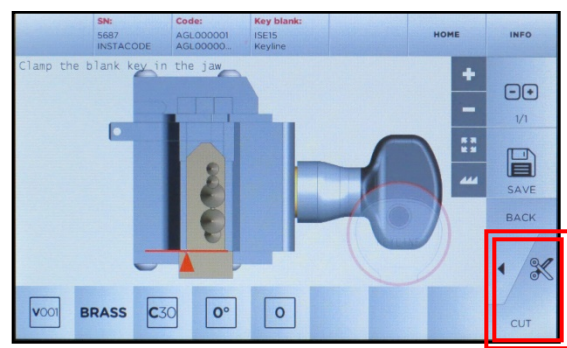

Clamp key blank in jaw, select **CUT**

Select **NEXT**, then proceed with cutting the key by code (refer to Page 13 – CUT BY CODE-DIMPLE., cont. to proceed with cutting)

CUT BY CODE - DIMPLE

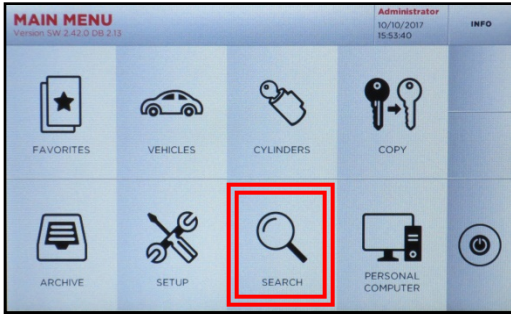

Select **SEARCH**



Select **KEY BLANKS**

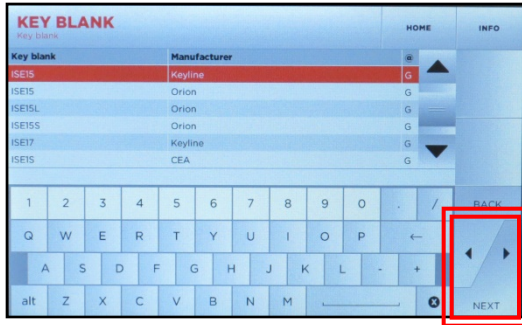

Select **KEY BLANKS**

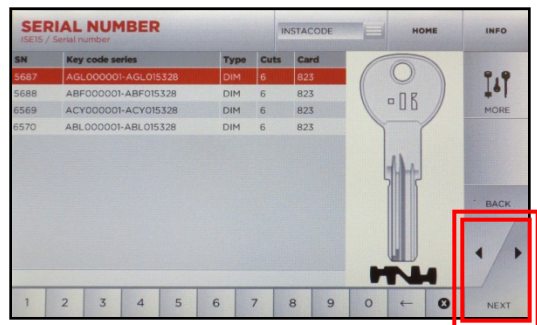

Select **SERIAL NUMBER**, then **NEXT**

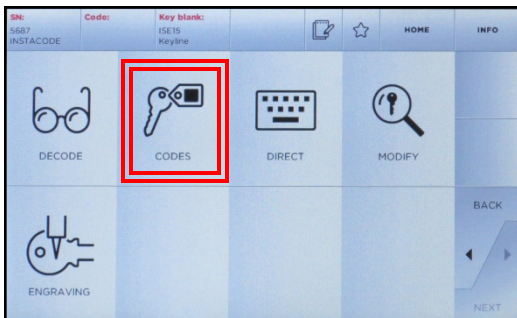

Select **CODES**

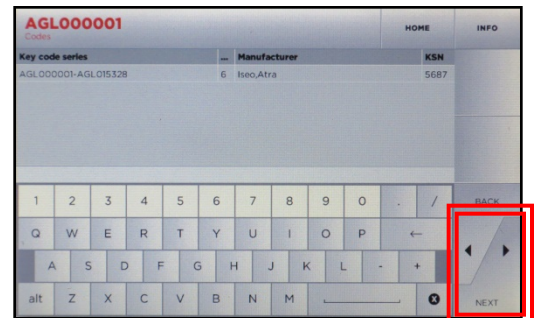

Input code, then select **NEXT**

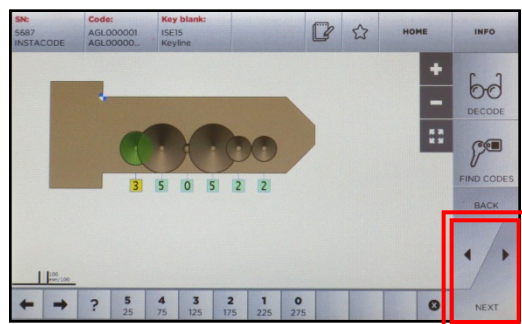

Depths appear, select **NEXT**

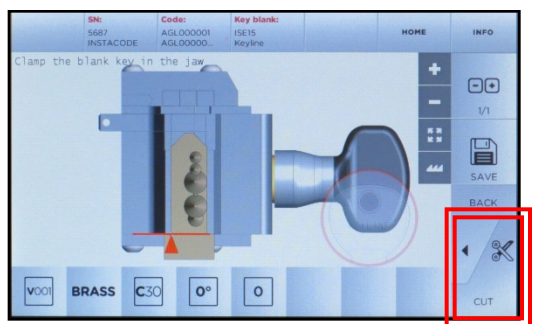

Clamp key blank in jaw, **close shield**

CUT BY CODE – DIMPLE, cont.

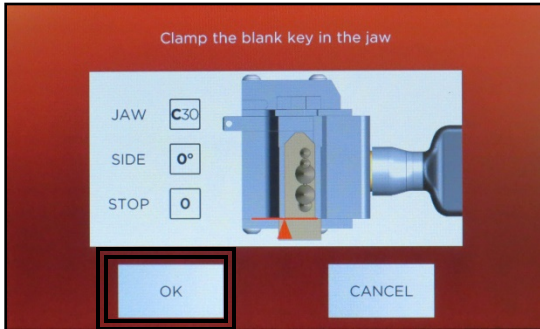

Confirm key is clamped, select **OK**

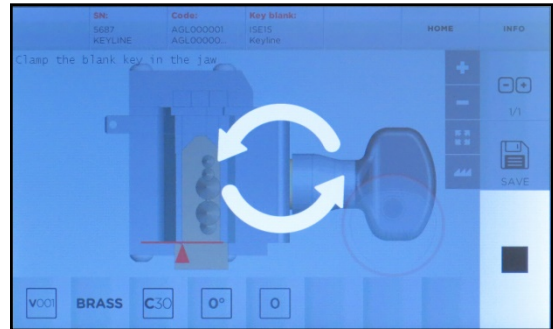

Key cutting in process

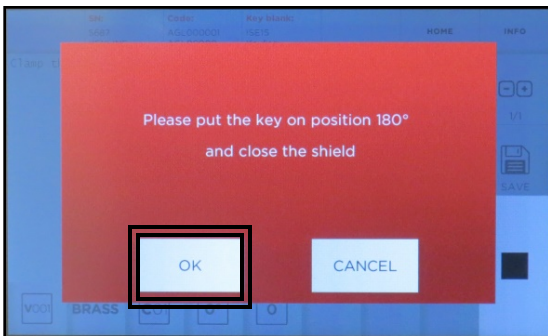

Rotate the key, then select **OK**

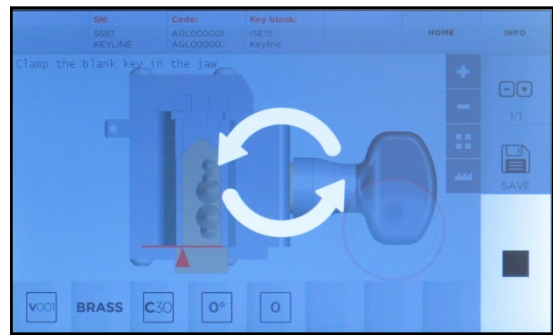

Key cutting in process

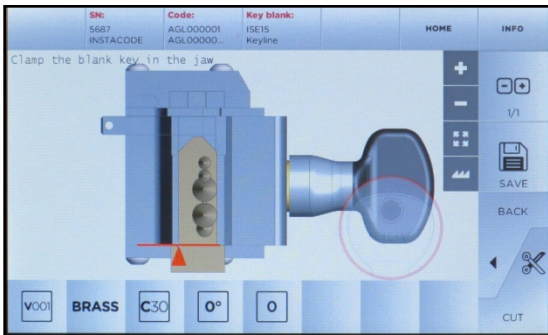

Key cutting complete.

Remove key and insert another key, then select **CUT** if you are making a duplicate of the same code. If finished, select **HOME** to go back to the Main Menu.

CUT BY DECODE – EDGE CUT

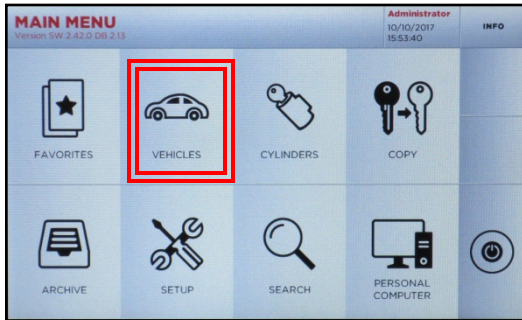

Select **VEHICLES**

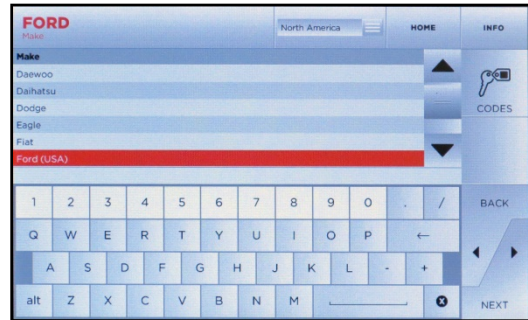

Select **MAKE**

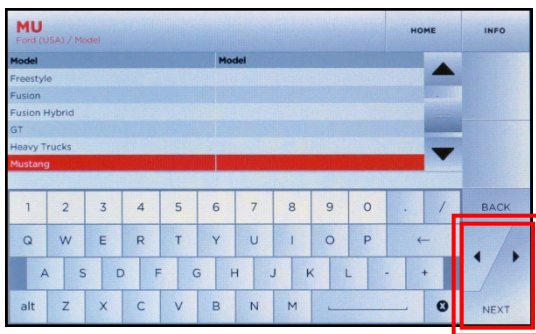

Select **MODEL**

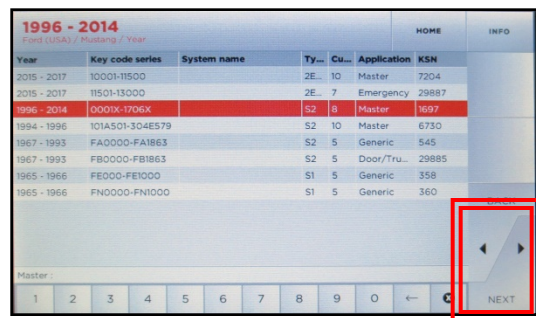

Select **YEAR**

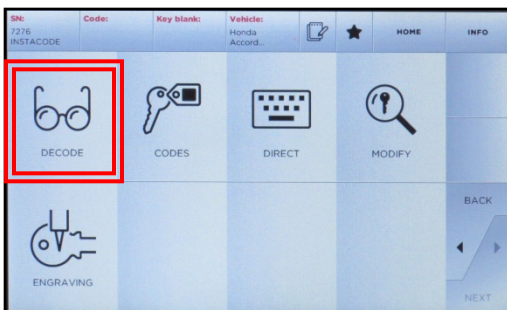

Select **DECODE**

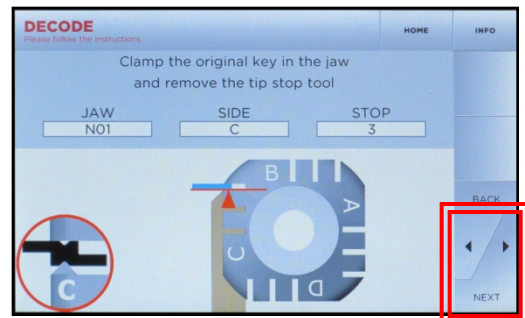

Insert key correctly on jaw, paying close attention to tip stop position (shown in **BLUE**). Tighten down key, then remove tip stop. **Close shield**. When key is ready, select **NEXT**

CUT BY DECODE – EDGE CUT, cont.

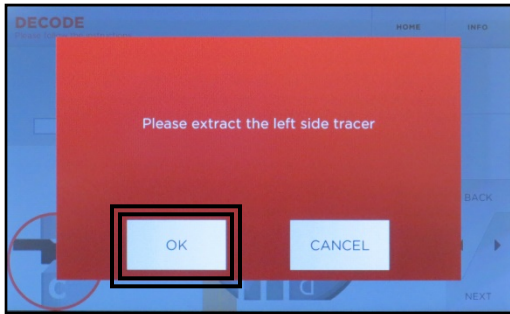

Extract left side tracer, then select **OK**

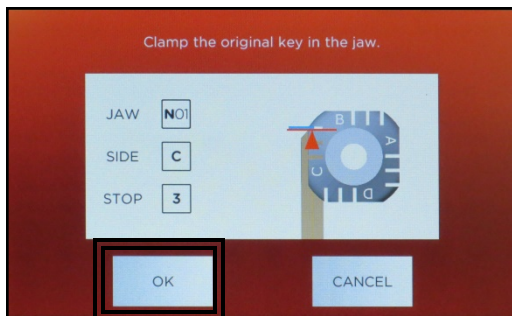

Select **OK**

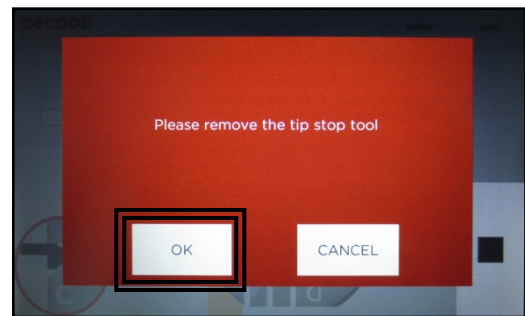

Confirm tip stop removal, select **OK**

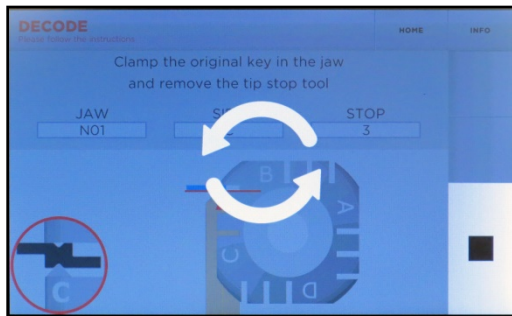

Decoding in process

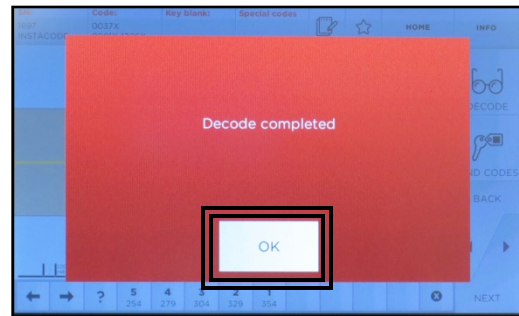

Decode complete; select **OK**

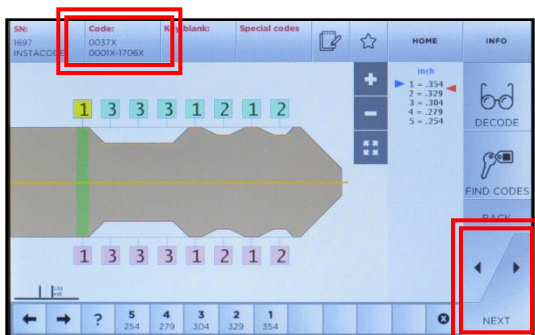

Depths and key code are displayed.

If proceeding to cutting, retract tracer, then select **NEXT** to proceed with cutting the key by code (refer to **Page 17 – CUT BY CODE-EDGE CUT**).

CUT BY CODE – EDGE CUT

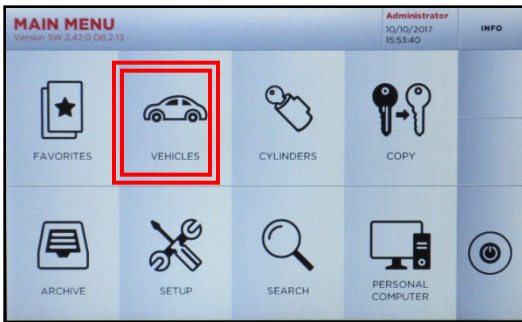

Select **VEHICLES**

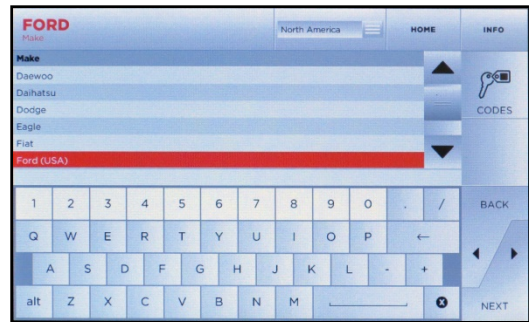

Select **MAKE**

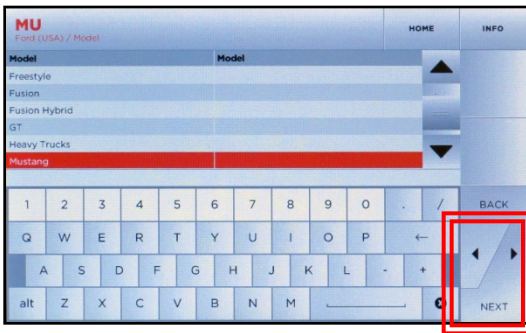

Select **MODEL**

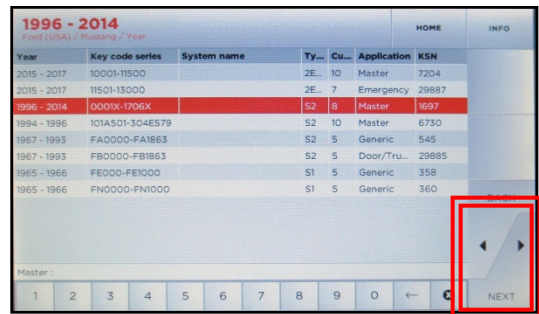

Select **YEAR**

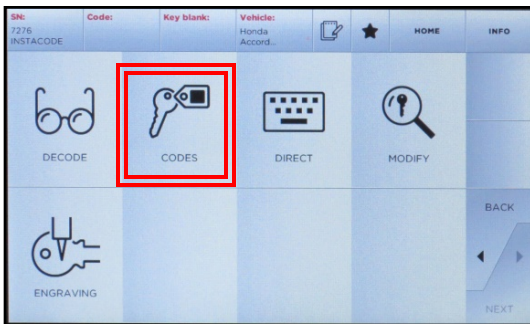

Select **CODES**

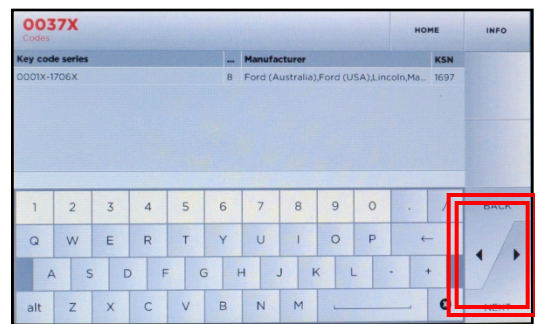

Enter code and select **NEXT**

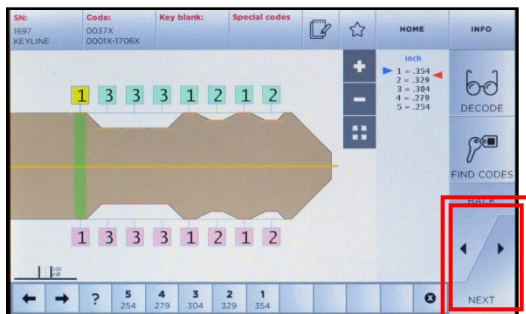

Key depths display, select **NEXT**

Select the correct jaw side as displayed on screen.

Jaw can be rotated by pulling up on the base of the jaw and rotating to correct side.

CUT BY CODE – EDGE CUT, cont.

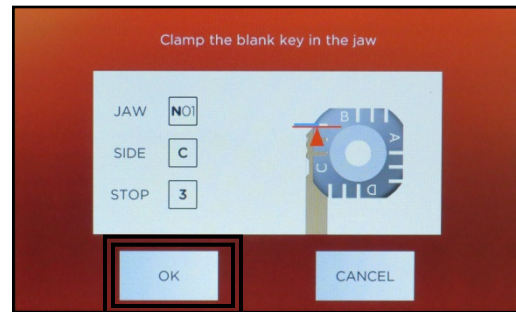
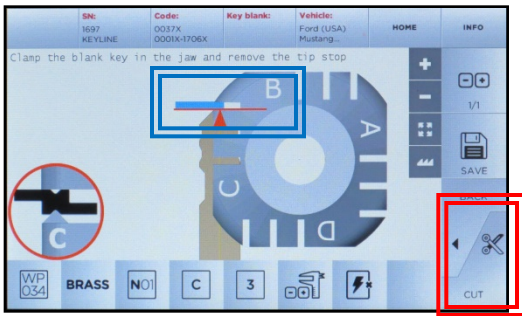

Insert tip stop and insert key to correct position as noted in **BLUE**. Tighten down jaw and remove tip stop. Select **CUT** once ready, then select **OK**.

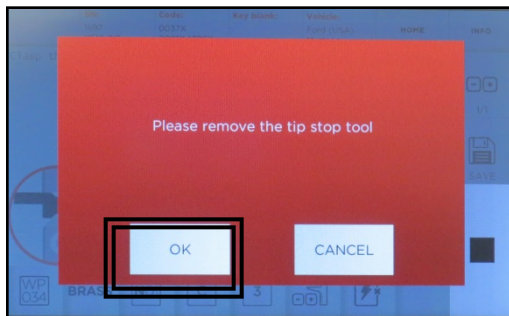

Confirm tip stop removal

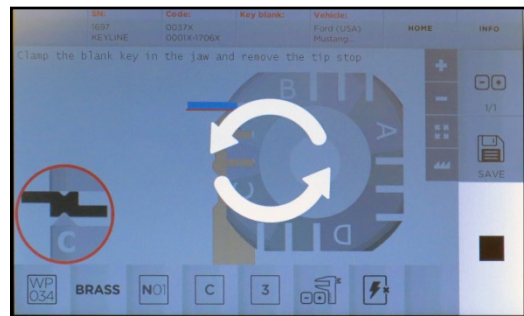

Key cutting begins

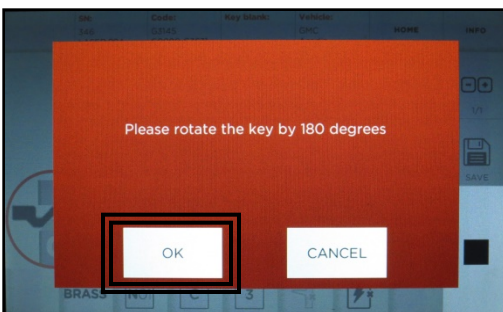

Rotate key and select **OK**

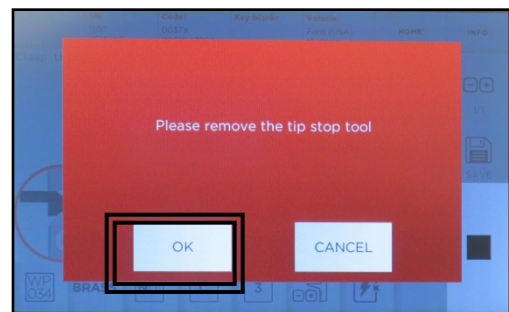

Confirm tip stop removal

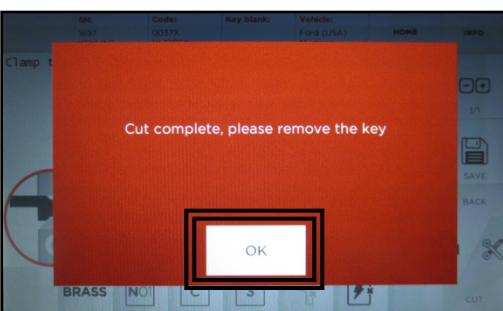

Cut complete, select **OK**

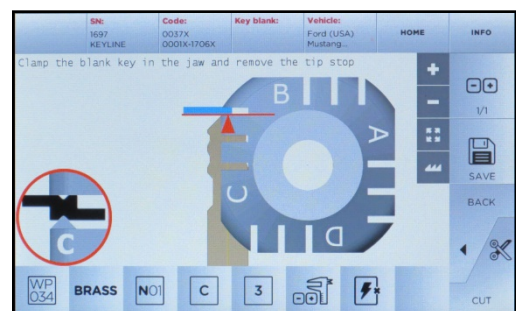

Insert additional key and select cut or select HOME for Main Menu

CUTTER REPLACEMENT

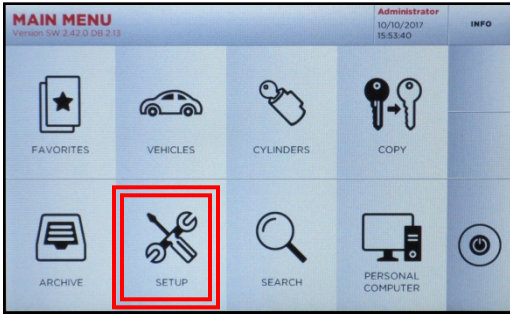

Select **SETUP**

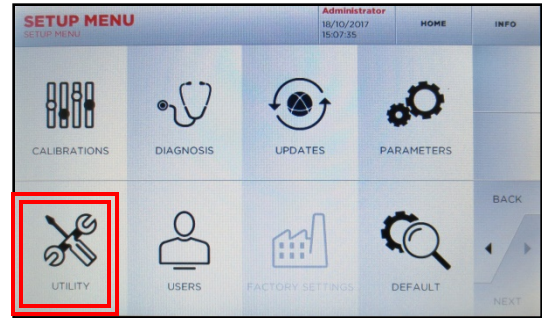

Select **UTILITY**

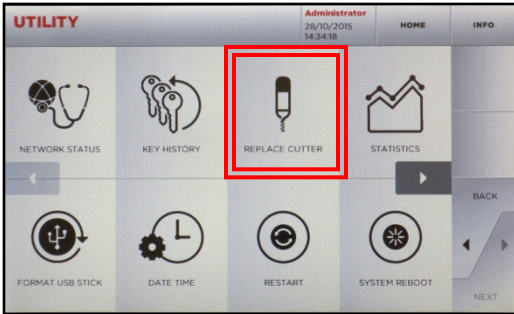

Select **REPLACE CUTTER**, make sure appropriate jaw is installed

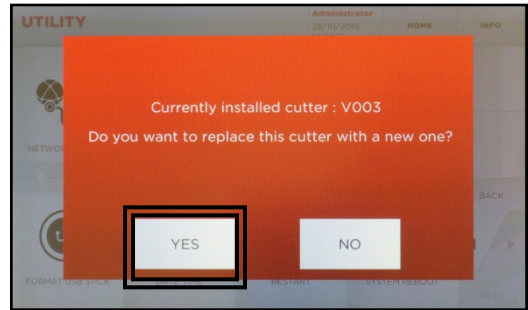

Current cutter installed displays, select **YES** to continue

TO REMOVE CUTTER:

1. Place your finger underneath the current cutter.
2. Press into black button on right side. Then turn the knob counterclockwise at the top ¼ turn until cutter is released.
3. Cutter will loosen from bottom and can be removed.

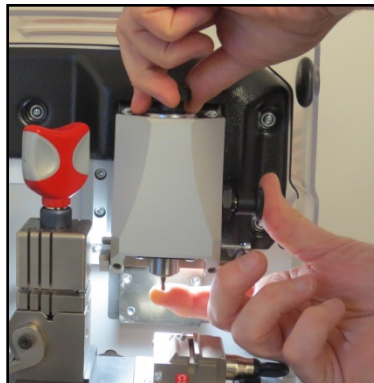
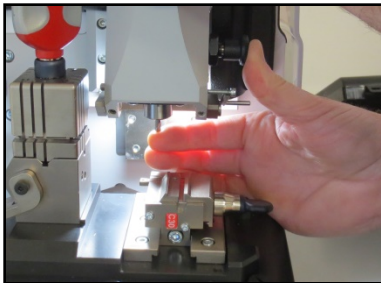

CUTTER REPLACEMENT, cont.

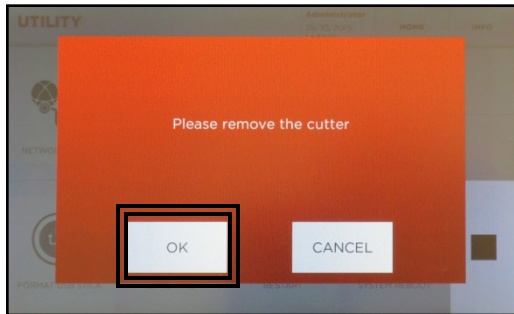

Once cutter is removed, select **OK**

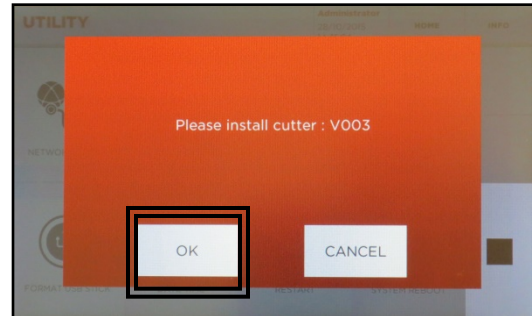

Install new cutter, then select **OK**

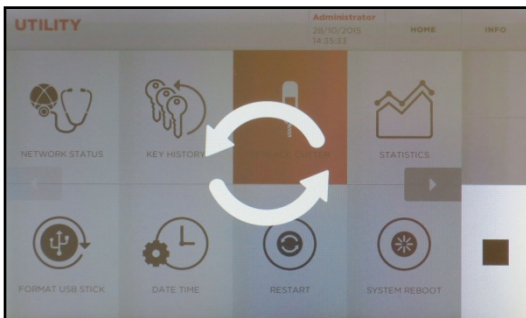

Machine checks that cutter is installed

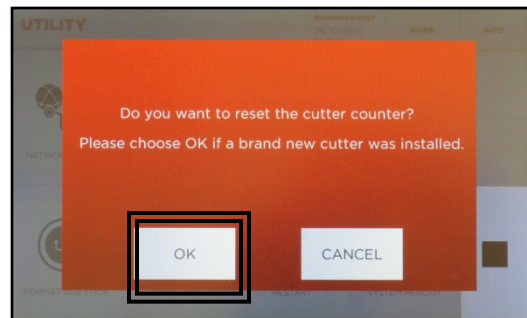

Select **OK** once complete

TO INSTALL NEW CUTTER:

1. Insert new cutter into cutter spindle holding in place.
2. Hold cutter in position with index finger while pressing black button on right, which prevents spindle from rotating .
3. Turn black knob clockwise until tight.
4. Cutter is now installed.

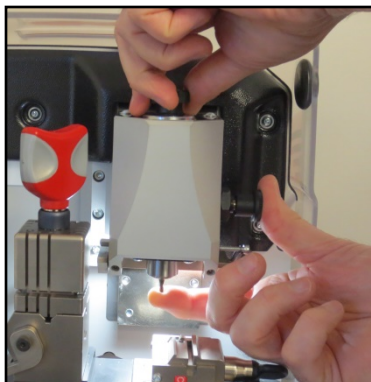
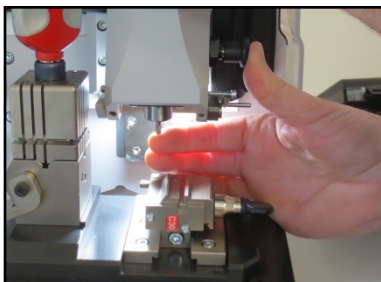

TRACER REPLACEMENT

TO INSTALL NEW TRACER:

1. Flip down tracer holder.
2. Using 1mm allen wrench, loosen set screw slightly until tracer can be removed.
3. Remove tracer.
4. Insert new tracer and tighten down set screw with 1mm allen wrench.
5. Tracer is now installed.

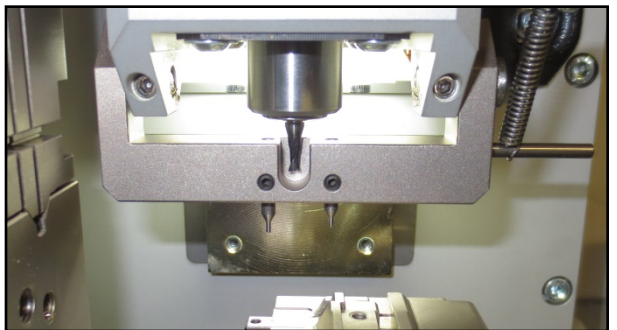
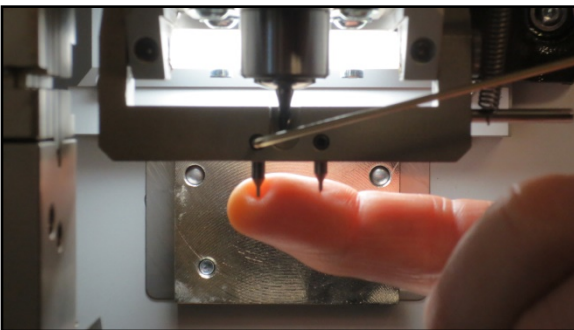
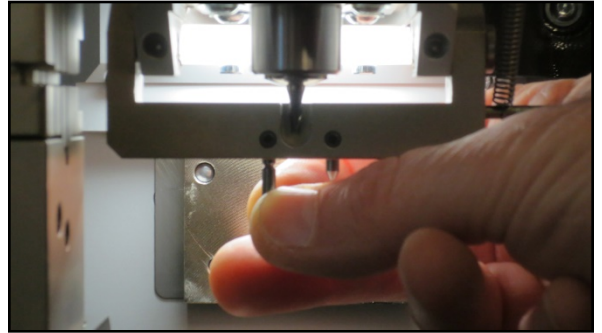
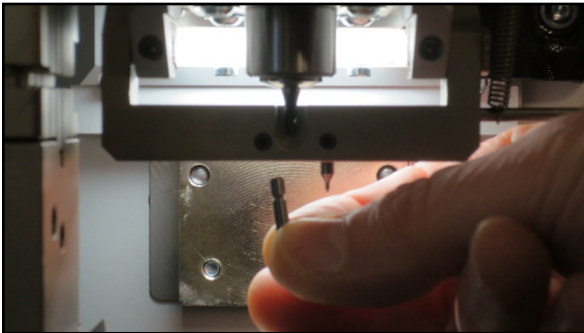
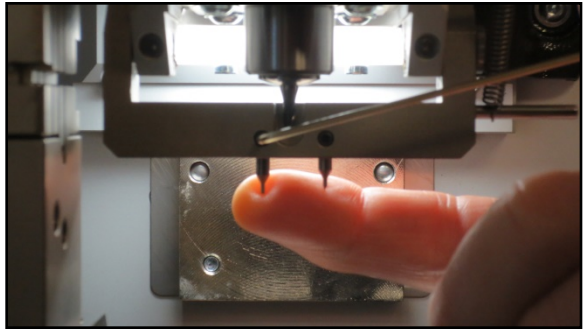
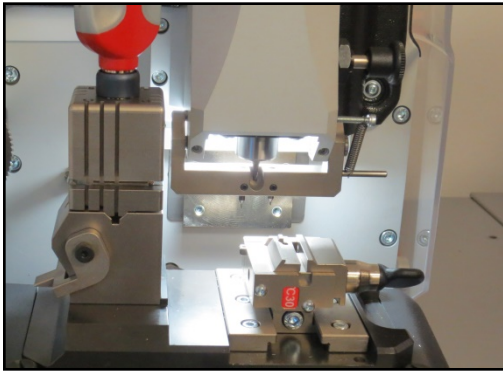

SOFTWARE UPDATE INSTRUCTIONS

SOFTWARE UPDATE VIA ETHERNET CABLE

WHAT YOU WILL NEED:



Console, Ethernet Cable and Internet Connection

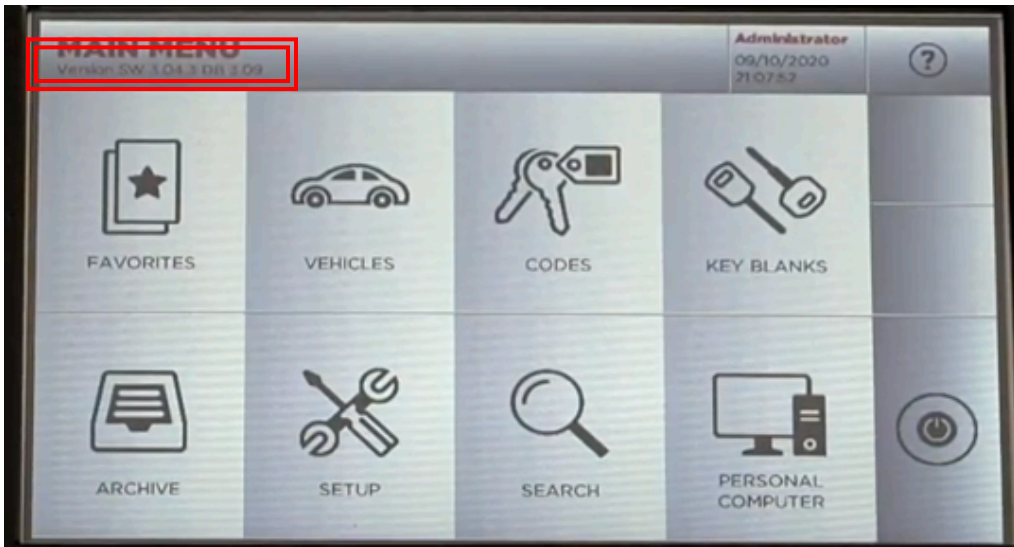

To check your current software version, see 'Version SW' below the Main Menu tab

STEP 1: Plug Ethernet Cable into Console from Internet

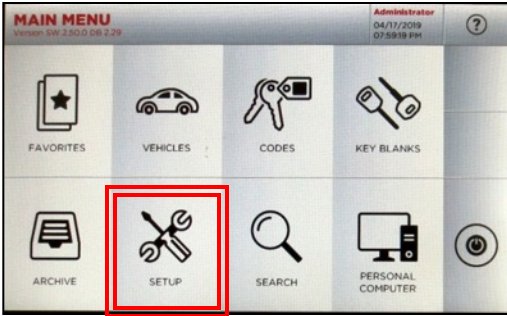

At **MAIN MENU**, select **SETUP**



At **SETUP MENU**, select **UPDATES**

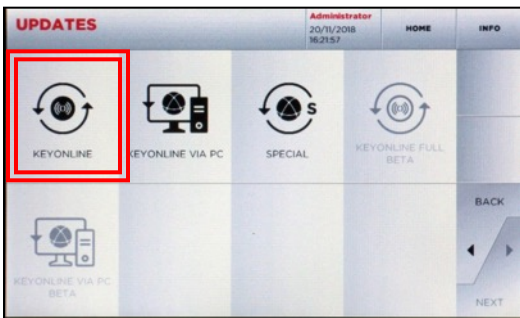

Then select **KEYONLINE**

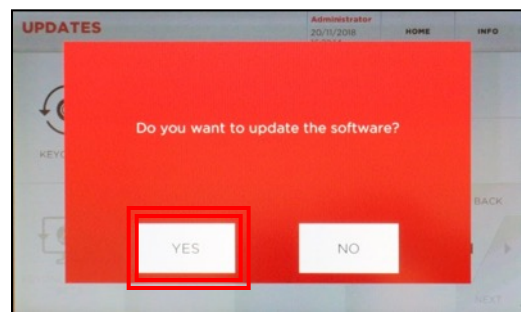

Select **YES** to update the software

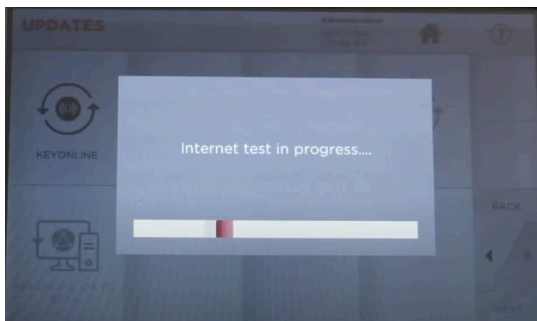

Internet test in progress

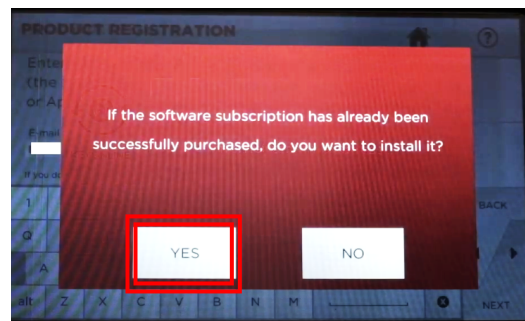

Select **YES**

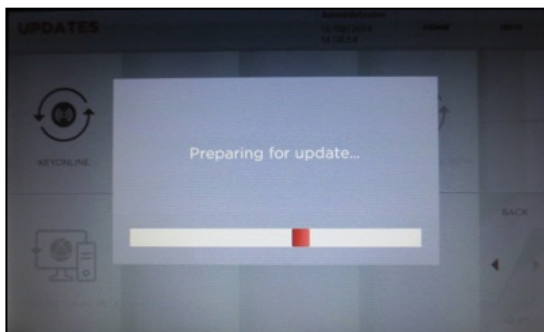

Console prepares software file

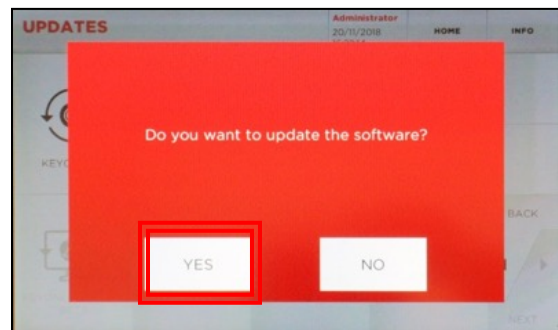

Select **YES** to update the software

STEP 2: Complete Software Installation on Console

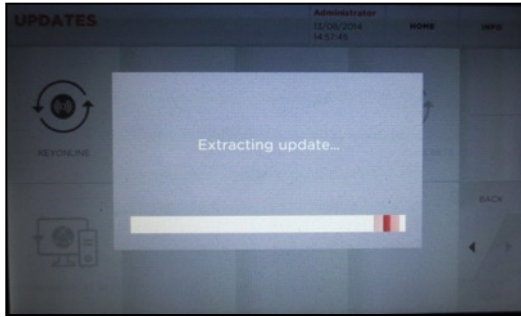

Wait for the update to finish



The system will reboot & finish the installation process

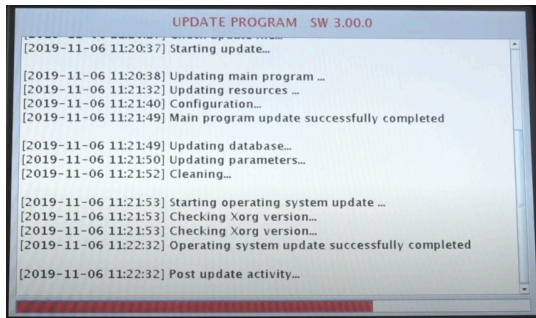

Update continues; progress bar on bottom

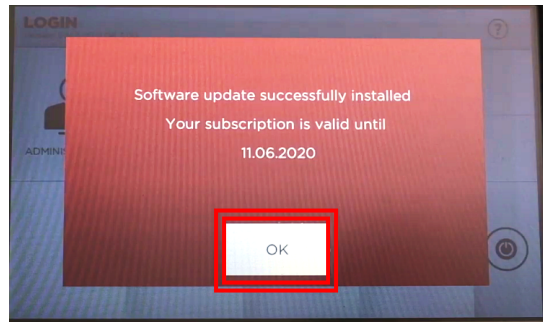

Update successful; select **OK**

SOFTWARE UPDATE INSTRUCTIONS

SOFTWARE UPDATE VIA USB MEMORY STICK & KEYONLINE WEBSITE

WHAT YOU WILL NEED:



Console, USB Memory Stick (included with machine), PC with Internet connection

NOTE: USB Memory Stick must be blank with no files on it

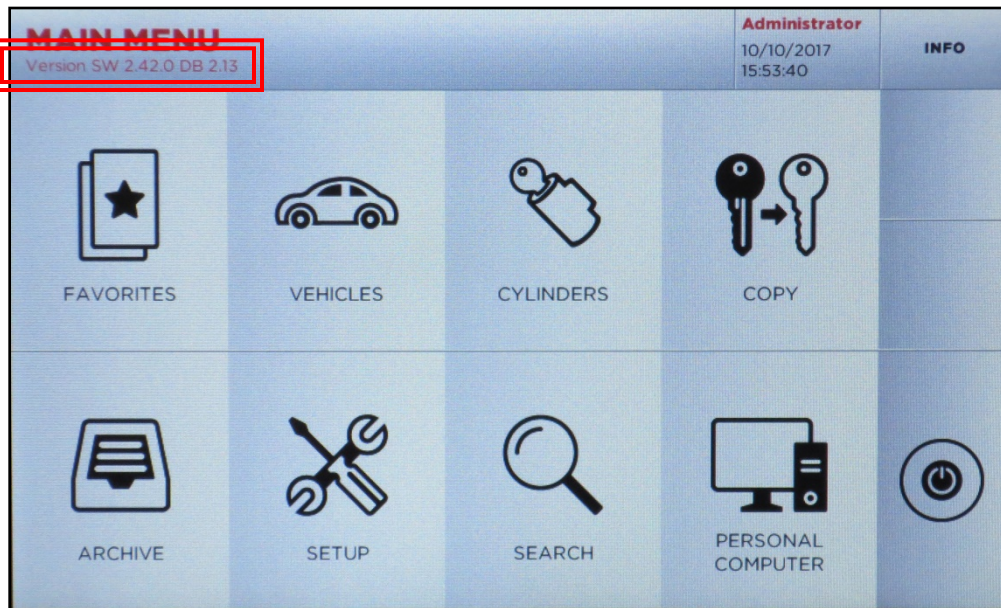

To check your current software version, see 'Version SW' below the Main Menu tab

STEP 1: Prepare USB Memory Stick with Update File

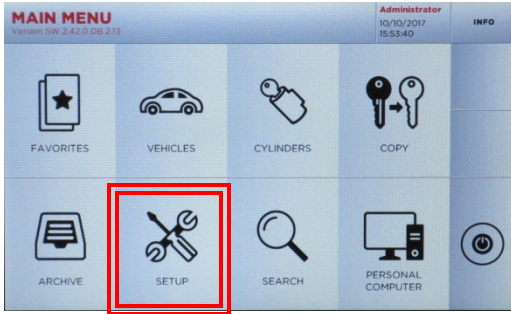

At **MAIN MENU**, select **SETUP**



At **SETUP MENU**, select **UPDATES**

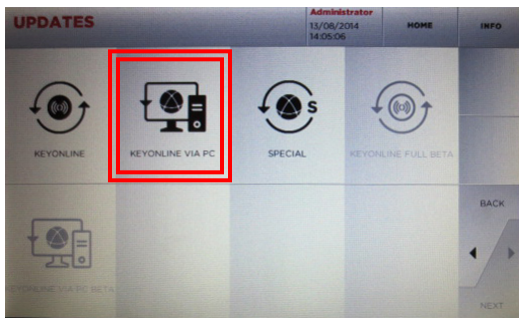

Then select **KEYONLINE VIA PC**

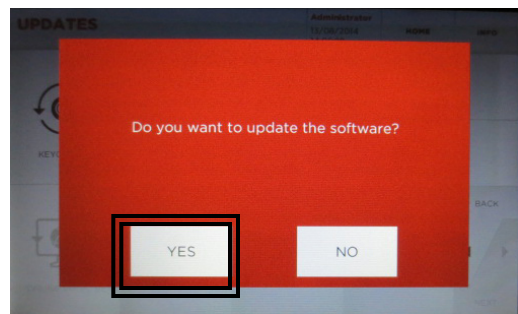

Select **YES** to Software Update

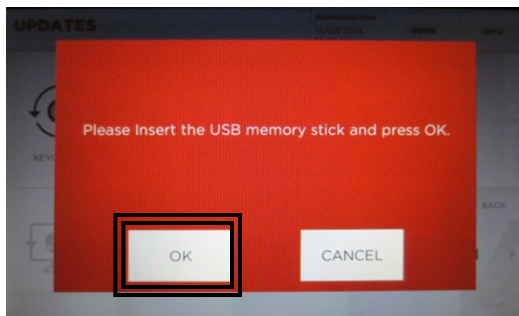

Insert USB Memory Stick, select **OK**



USB stick inserts on right side of console

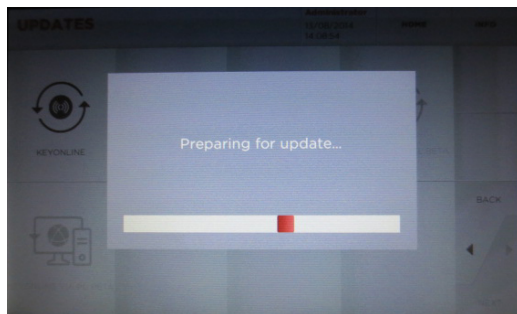

Console prepares software file

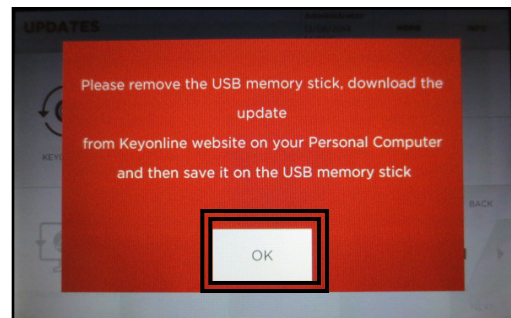

Remove USB stick, Select **OK**

STEP 2: Install Update File on USB from PC



Insert USB stick into USB port on PC then go to <http://keyonline.keyline.it>

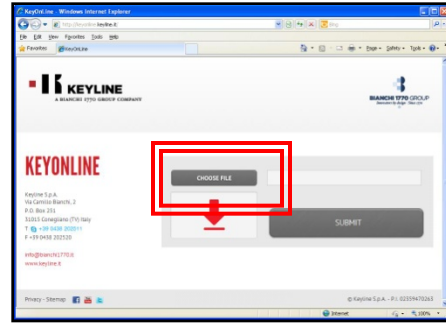

On site, double-click **CHOOSE FILE**

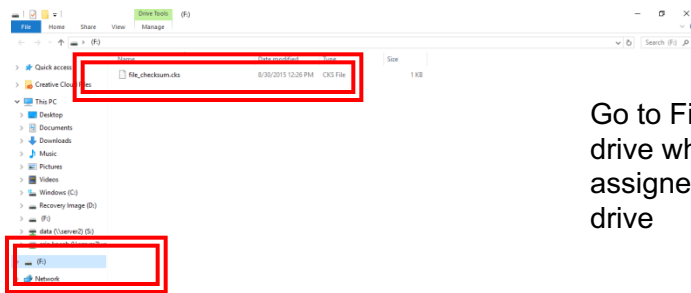

Go to File Explorer, locate the drive where the USB stick is assigned and double-click the drive

Highlight the '.cks' file listed and click **OPEN**

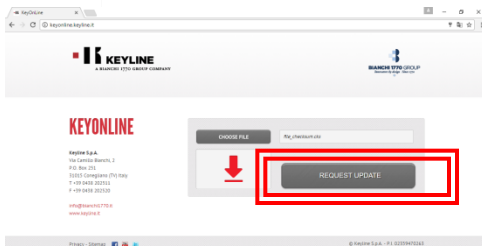

The '.cks' file now appears in the box on the Keyonline site, then click **REQUEST UPDATE**

A pop-up box will appear that says **"This action may take some time"**

Click **OK** when this message appears

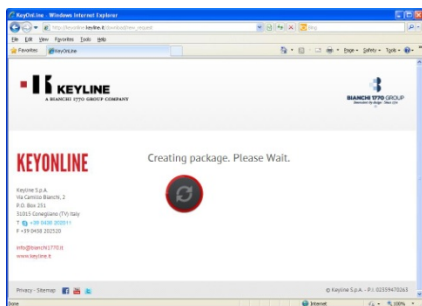

Software package creation will begin. This take up to a few minutes depending on your Internet speed.

STEP 2, cont: Install Update File on USB from PC

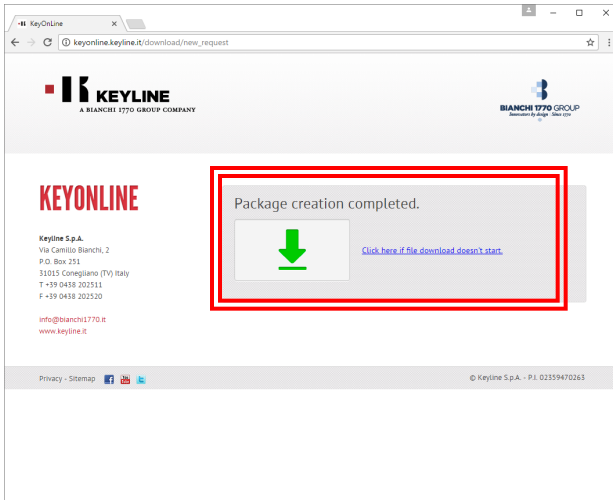

Package creation completed should appear. You will be prompted with a pop up at the bottom of the screen, that shows the downloaded file. Click on the drop down arrow to the right of the download file and select **OPEN IN FOLDER**

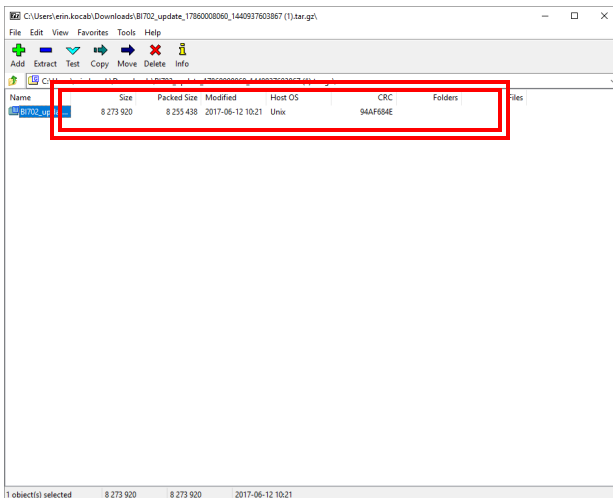

Once you have the downloaded file folder up, locate the USB drive with the original file you downloaded from the Ninja Laser console. Drag the new file that you created from Keyonline to the USB drive (NOTE: Do not extract the file – just drag and drop). The file will begin downloading to the USB stick.

Once the update file has finished installing you will then have two items on your USB stick. The original .cks file you downloaded from the USB and the file you downloaded from Keyonline.

Safely eject the Removable Disk from your drive. To eject, right click on the drive letter and select Eject. You can now take the USB memory stick back to your console to complete the software update.

STEP 3: Complete Software Installation on Console

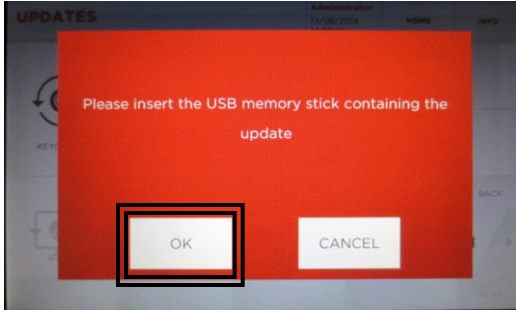

Insert USB into console and select **OK**

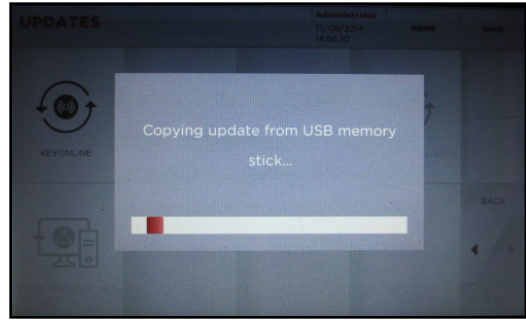

Update begins

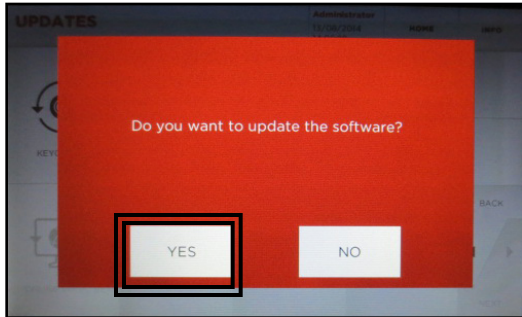

Select **YES** to confirm update

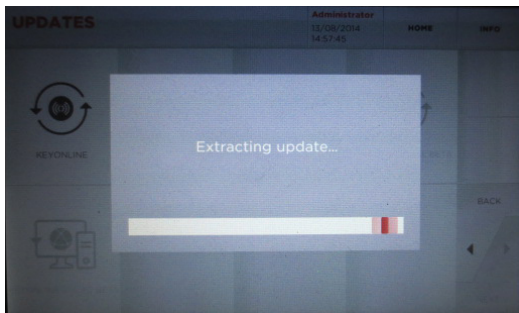
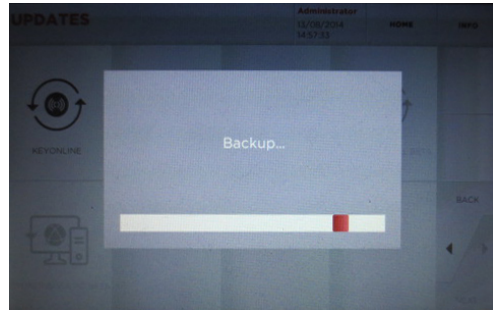

Machine will re-boot and power back up as update continues

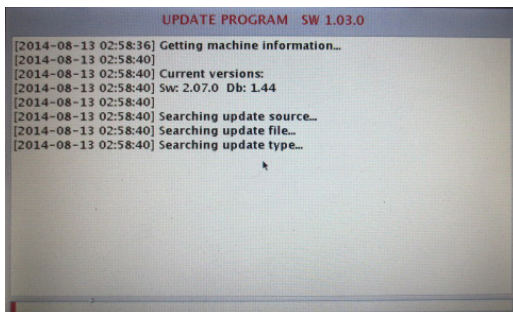

Update continues; progress bar on bottom

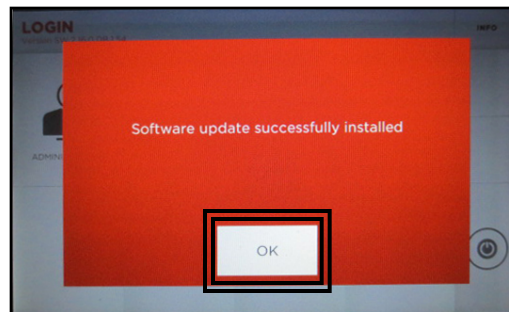

Update successful; select **OK**

FAVORITES

Selecting Favorites helps bypass Make, Model and Year selections that you most commonly use to get you right to the Code/Decode/Direct screen

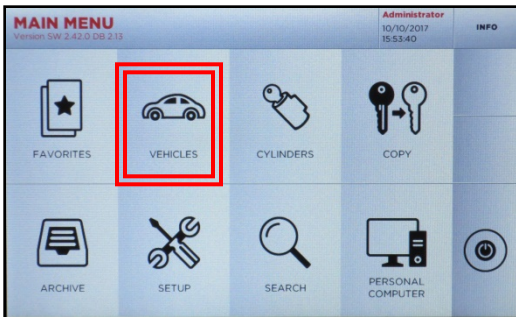

At Main Menu, select **Vehicles**

Go through the menu and select the Make, then the Model, then the Year and Code Series range of the vehicle you want to save a favorite for

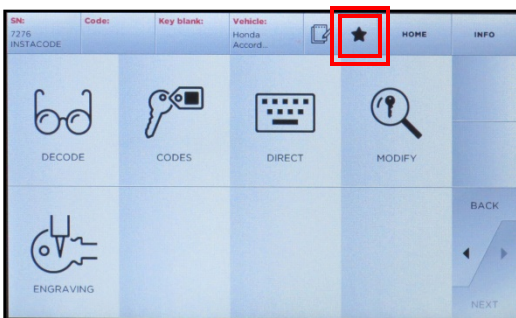

Select the Star icon from the top Menu bar

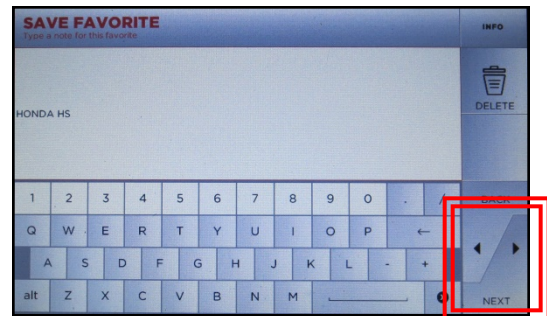

Enter the text for the Favorite you are adding, then select **Next**

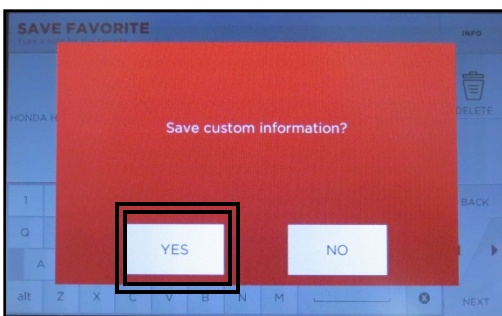

Select **YES** to save custom info

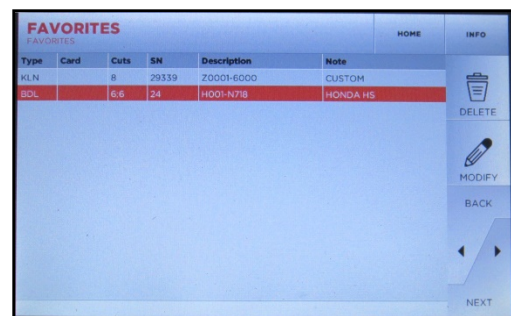

From the Main Menu select Favorites and the saved favorite will now be listed. This can be selected for future keys to bypass the Make, Model and Year selection and go right to Decode/Codes/Direct menu

NINJA TOTAL REPLACEMENT PARTS & ACCESSORIES

Description	Part Number
V001 Dimple Cutter	RIC05044B
T02 Dimple Tracer	RIC05352B
V003 High Security Cutter	RIC05048B
T01 High Security Tracer	RIC05348B
V000 Engraving Cutter	RIC05050B
63mm Carbide Cutter	RIC09168B
A02 Clamp – High Security	OPZ04873B
A03 Clamp – High Security [included]	OPZ04875B
A04 Clamp – High Security	OPZ04877B
C30 Clamp – High Security & Dimple [included]	OPZ10569B
C25 Clamp - Engraving	OPZ09335B
C34 Clamp – Tubular	OPZ10677B
C41 Clamp – Tibbe	OPZ10588B
Ford Adaptor (AV12) [included]	OPZ10582B
Infiniti/Mercedes Adaptor (AD05)	OPZ10269B
Lexus/Hyundai/Kia Adaptor (AD06)	OPZ10631B
Volvo Adaptor (AD09)	OPZ11008B
Cutter Belt	RIC09953B
4mm T-handle Wrench	RIC08684B
Console Arm Support for X style console	OPZ11120B
Anti-glare console screen protector	B9979
4GB USB Flash Drive for Software Updates	PROMO12-015