



SOFTWARE OPERATING GUIDE

FUTURA *EDGE*



vers. 1

Edition: April 2018

(c) 2018 SILCA S.p.A. - Vittorio Veneto

reserves the rights to alter the information without prior notice, except when they affect safety. This document or any of its parts cannot be copied, altered or reproduced without written authorization from the Manufacturer. Keep the manual and look after it for the entire life cycle of the machine. The information has been drawn up by the manufacturer in his own language (Italian) to provide users with the necessary indications to use the key-cutting machine independently, economically and safely.

IMPORTANT NOTE: in compliance with current regulations relating to industrial property, we hereby state that the trade-marks or trade names mentioned in our documentation are the exclusive property of authorized manufacturers of locks and users. Said trade-marks or trade names are nominated only for the purposes of information so that any lock for which our keys are made can be rapidly identified.

INDEX

• PROGRAM START	5
• CHOICE OF KEYBOARD	6
• CHANGE PROGRAM LANGUAGE	6
• MEASURING UNITS.....	6
• DROP-DOWN MENU	7
1 SEARCHES	8
1.1 STANDARD keys	8
1.2 VEHICLE keys.....	8
1.3 FULL KEY SEARCHING	8
1.4 TRASPONDER GUIDE	8
1.5 DATA CARD/SERIE info.....	12
1.6 Using a CUTTING DATA CARD	14
1.7 CUTTING STANDARD flat keys (cylinder and vehicle).....	22
2 COPY BY ORIGINAL.....	23
3 FAVORITE'S	25
4 QUEUE OF JOBS.....	26
4.1 "STANDARD" QUEUE OF JOBS	26
5 OPTIONS.....	27
5.1 INFO	27
5.2 CALIBRATION.....	28
5.2.1 STANDARD key clamp calibration	28
5.2.2 STANDARD key Adapter calibration	30
5.3 SETTINGS	31
5.3.1 Zero-point Calibration (STANDARD key)	31
5.3.2 Options.....	33
5.3.2.a General.....	33
5.3.2.b Preferences STANDARD key	35
5.3.3 USE	36
5.3.3.a ACCESS POINT mode (Wi-Fi connection between machine and Tablet)	36
5.3.3.b ETHERNET with connection to LAN and router	38
5.3.3.c TETHERING USB mode.....	39
5.3.3.d LOCAL NETWORK mode.....	41
5.4 MACHINE MAINTENANCE.....	45
6 MACHINE UPDATE and REGISTRATION	49
6.1 MACHINE REGISTRATION	49
6.2 MACHINE SOFTWARE UPDATE	55
6.2.1 Update by TABLET.....	55
6.2.2 Update by USB PEN	57
6.2.3 Update with LOCAL NETWORK connected to the internet.....	58
6.2.4 Update with SRS Program (Silca Remote Service)	60
6.3 APP UPDATE (Silca.apk and SilcaKeyboard.apk).....	62
7 BACKUP / RECOVERY	65
8 USER SERIES.....	66
9 CODE MAKER.....	70
10 TRASPONDER GUIDE	71
11 CHANGING TABLETS.....	73
12 FUTURA PROCEDURE TO CLEAR CACHE	76

• PROGRAM START



To start the program tap the icon  on the Tablet screen.

If the program does not start check the network settings/use (see Ch.5.3.3).

FUTURA EDGE

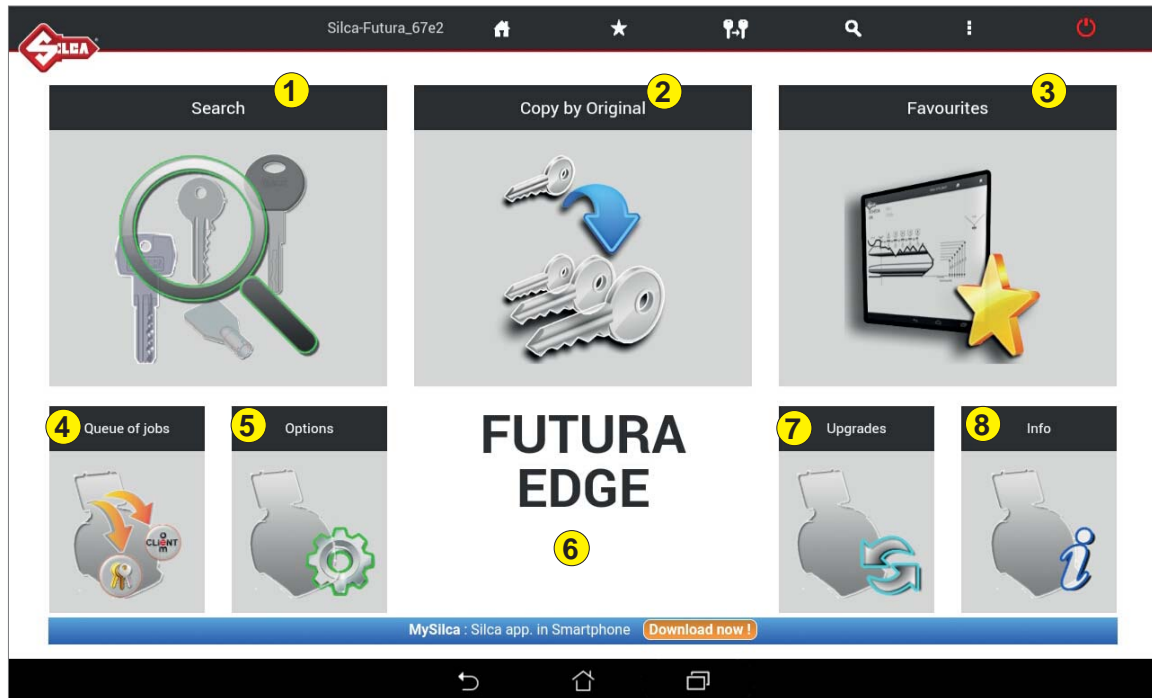

1- Search

Menu used to select a category of Series Searches.

5 - Options

Menu used to set up the machine.

2 - Copy by Original

Menu used to make a copy of a key by means of a laser reader (standard edge cut keys only).

6

The name of the machine model being used is shown.

3 - Favourites

Menu used to access a series of searches previously set up as favourites.

7 - Upgrades

Menu used to update machine software.







4 - Queue of jobs

Menu used to run the job queue previously created by the search menu.

8 - Info

Menu showing machine details.



- Silca-Futura_bbe3** **Machine ID:** shows the name of the FUTURA EDGE machine.
-  **Initial menu:** tap the symbol to go back to the initial menu.
-  **Favourites:** tap the symbol to view the data cards/series saved in the favorites menu.
-  **Copy by Original:** tap the symbol for direct access to the “Copy by Original” menu.
-  **Search menu:** tap the symbol for direct access to the “Search” menu.
-  **Information:** tap the symbol to view information about the FUTURA EDGE machine
-  **Turn off machine:** tap the symbol to turn off the FUTURA EDGE machine without affecting the software; wait until the green light goes out and then turn off the machine with the ON/Emergency push button.

• **CHOICE OF KEYBOARD**

When the FUTURA program is started you are required to choose the type of keyboard you will use for entering data.

SILCA Keyboard: smaller keyboard specially designed for the FUTURA program.

ASUS Keyboard: standard Android Tablet keyboard.



If you have chosen the Silca keyboard you can go back to Android by hitting the key on the Silca keyboard.



• **CHANGE PROGRAM LANGUAGE**

The default program language is English. To change language go to the **Options** menu (Ch.5), select **Settings** -> **Options** -> **General** -> **Language** and choose the language you require.

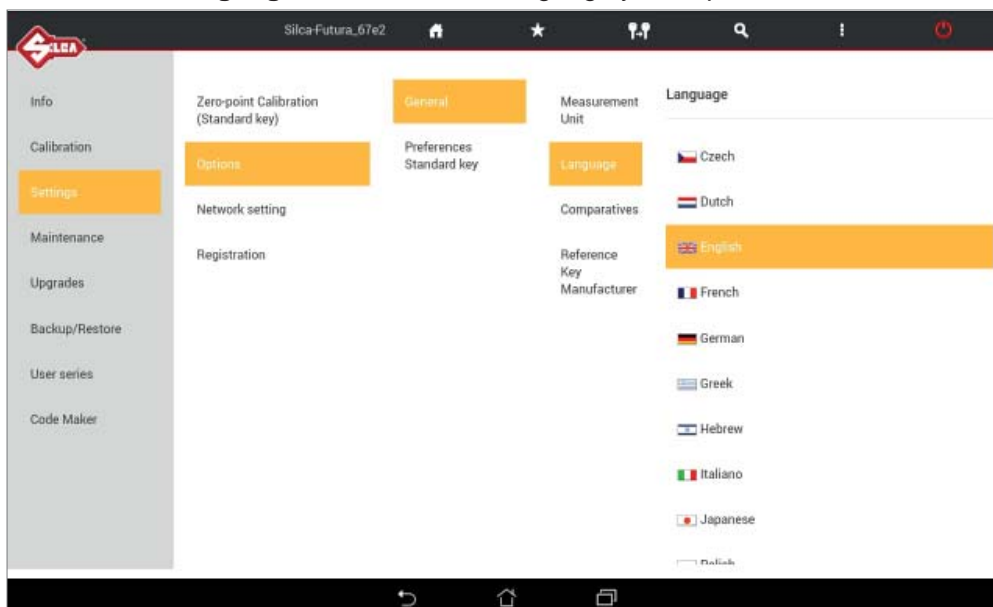

• **MEASURING UNITS**

All the values given in the program for the technical measurements of keys and clamps are expressed in hundredths of a millimetre (default) or thousandths of an inch, according to the measuring unit chosen from the “Options” menu.

• DROP-DOWN MENU

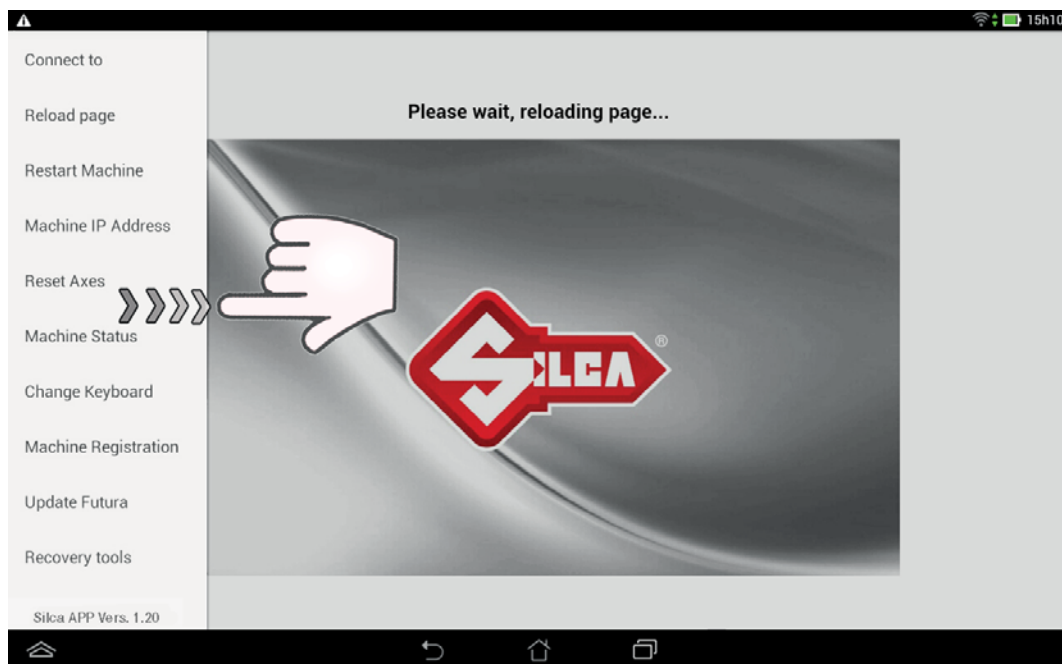

To view this menu on the Tablet scroll from left to right to open the list:

Connect to: used to find the Futura Edge machine, if there is a LAN connection or Wi-Fi ACCESS POINT.

Reload page: used to reload the page if it is not properly viewed/activated.

Restart Machine: used to restart the machine.

Machine IP address: used to enter the Futura Edge IP address manually (default is 192.168.0.1).

Reset Axes: used to clear the axes on the machine.

Machine Status: used to see connection status between the machine and Tablet.

Change Keyboard: used to select and set the type of keyboard to be used (Silca or ASUS keyboard)

Machine Registration: used to register the machine when the Tablet is connected to a Wi-Fi network with internet access.

Update FUTURA: used to download new updates for the machine:

- by tablet connected to a Wi-Fi network with access to the internet (Ch.6.2.1).
- by USB PEN DRIVE and PC with access to the internet (Ch.6.2.2).

Recovery tools: this function is protected by a password and is for the exclusive use of Silca personnel.

In addition, the Silca App version installed on the Tablet is shown below.

1 SEARCHES

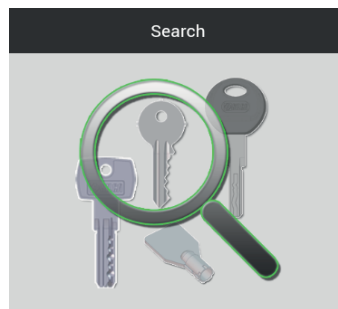

When the Searches menu is opened, the following window appears:



1.1 STANDARD keys

Menu used to make a search restricted to the category flat keys only (e.g.: CS207 - YA31 - UL050 ...).

1.2 VEHICLE keys

This menu is used to restrict a search to the category of standard edge cut vehicle keys only (e.g.: GT15R - YM28T2 ...)

1.3 FULL KEY SEARCHING

This menu is used to make extended searches not restricted to categories.

1.4 TRASPONDER GUIDE

The Transponder Guide contains all the transponder key copying solutions provided by Silca (Ch.9).

See example of STANDARD keys search flow:

When you enter the STANDARD keys category the following window appears for you to enter the search parameters.

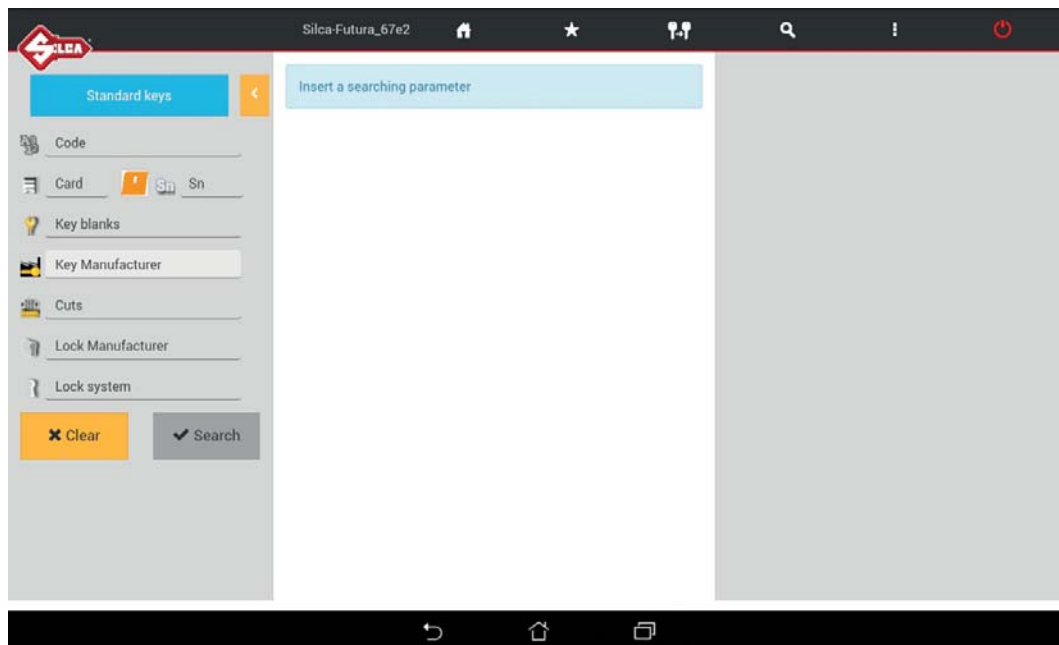
**SEARCH Parameters**

Code: enter the indirect key-cutting code.

Card / Sn: enter the card number or serial number assigned by Silca.



Instacode icon: it's possible to search for a card into Instacode program.

This function is enabled in some versions. For all others it can be requested as optional.

Key blanks: enter the Silca/Ilco key blank code or comparative.

Key manufacturer: enter name of key manufacturer.

Cuts: enter number of cuts for the key to be included in the search.

Lock Manufacturer: enter the brand of lock to be included in the search.

Lock system: enter the name of the lock system.

Press "**Clear**" to delete the entered fields.

After entering one or more parameters, tap the "**Search**" button to start the search. This operation will show the data relating to the lock systems found and information about the Silca/Ilco key blank, if applicable.

Tap  on the left-hand side of the page to re-open the Search Parameters window.

See example of VEHICLE keys search flow:

When you enter the VEHICLE keys category the following window appears for you to enter the search parameters.

Tap “VEHICLE MAKE”; a guided procedure appears to simplify your search.

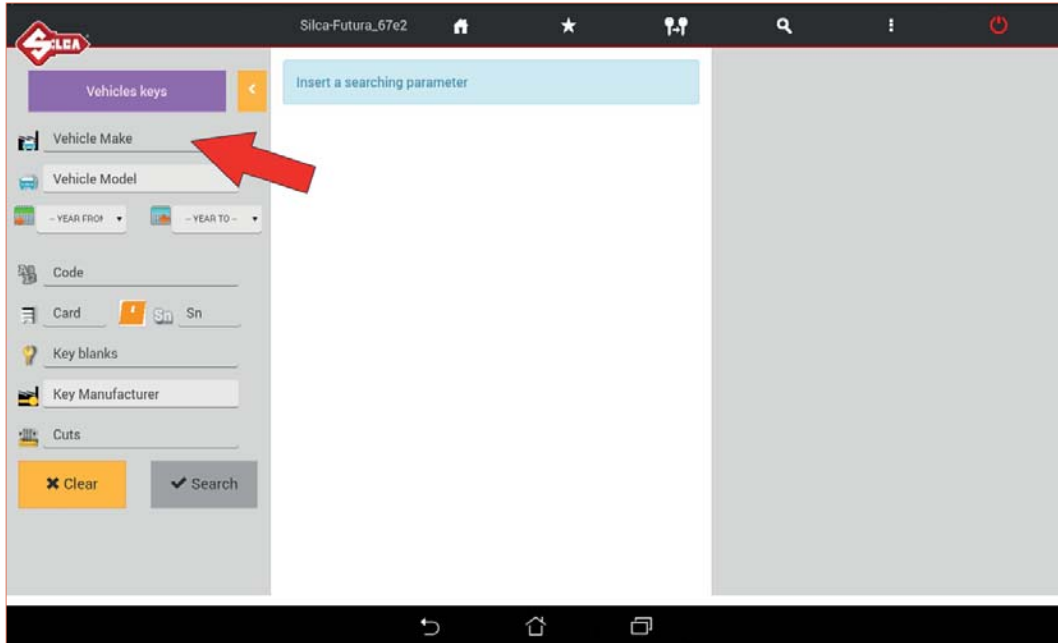

Enter the first letters of the MAKE and select the one you require.

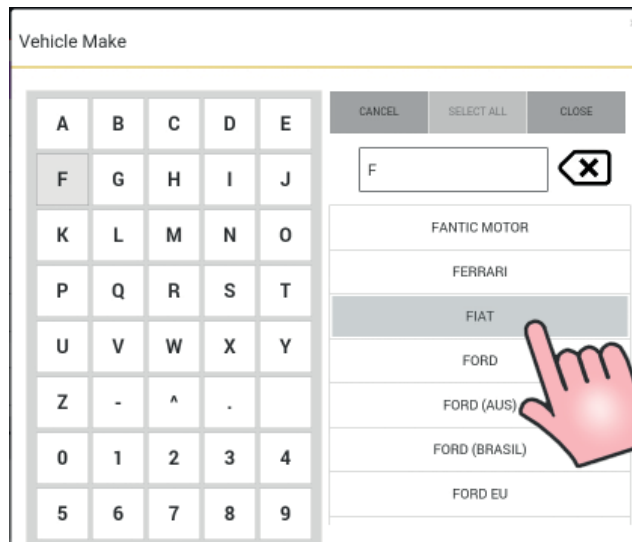

Enter the first letters of the VEHICLE MODEL and select the one you require.

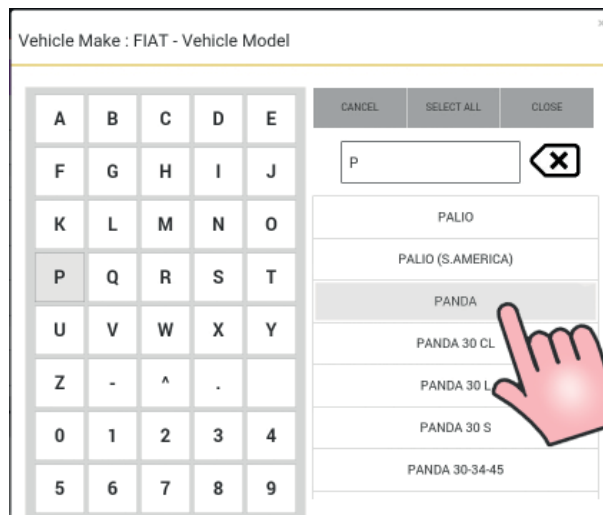

Select the YEAR.



Select the CARD key to access the cutting data card.

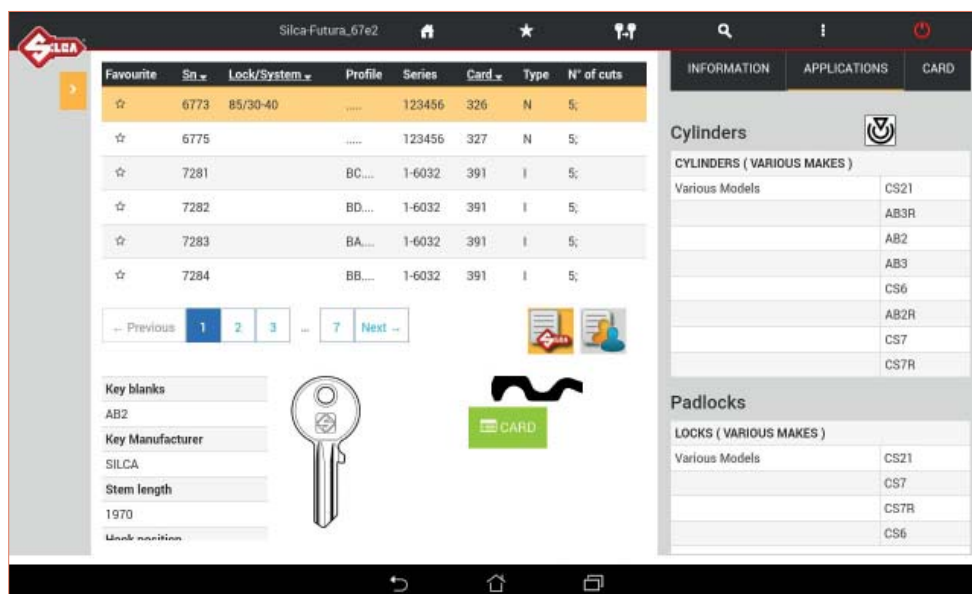



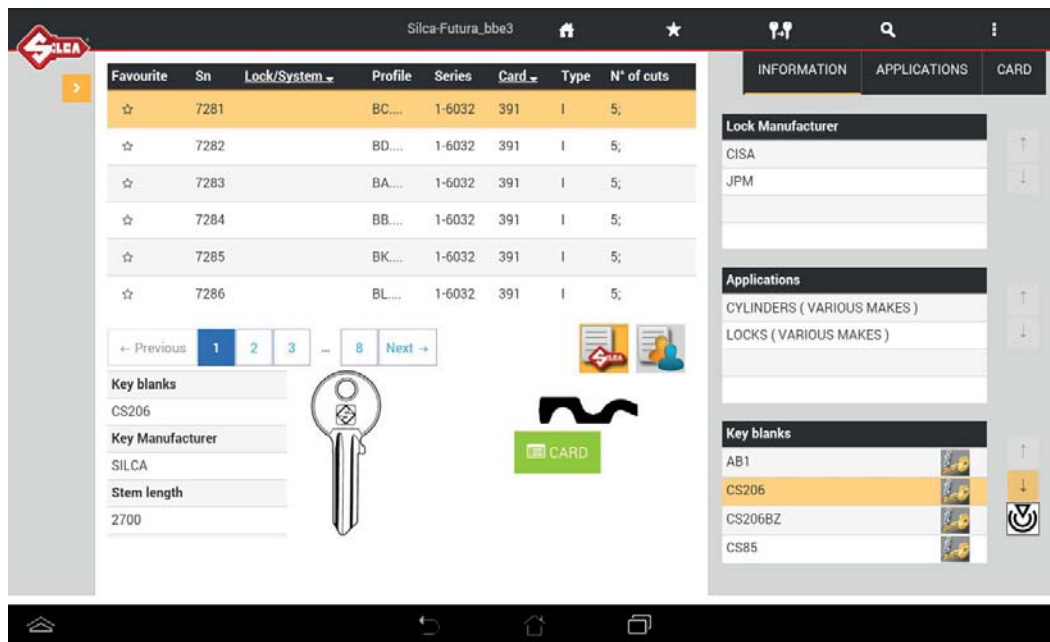

1.5 DATA CARD/SERIE info



To access the cutting card select the relevant line and tap the “OPEN CUTTING CARD” button.

In the section of the window showing the search results

Favourite	Sn	Lock/System	Profile	Series	Card	Type	N° of cuts
-----------	----	-------------	---------	--------	------	------	------------

- Order searches by tapping the arrow next to the relative fields.
- Select a series from those shown, or search for it on the next pages: 
-  Tap this icon to access the “Transponder Guide” (for vehicle keys).
- Select the “Silca” or “User” series:
 -  “Silca” is the default icon for viewing Silca series.
 -  tap “User” to view the existing user series (Ch.8) associated to the selected card.
- Tap the special field to enter the Hook position: it is automatically saved when the keyboard is turned off.

There are “3 folders” on the right of the screen:

INFORMATION: shows information about the lock make, applications and Silca/Ilco key blank. Info about a key can be viewed by tapping the field relating to the key blank.

APPLICATIONS: shows the applications for which this key blank is used: locks, cylinders, vehicle model, etc.

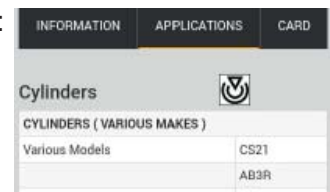

CARD: shows information relating to cutter and clamp needed for cutting keys with the Futura Edge key-cutting machine.



KEY BLANK

To gain access to additional information regarding the Silca key blank simply tap on the following icon 

- List of other Silca key blanks that can be used
- List of comparative key blanks
- List of Brand names linked to the Silca key blank.

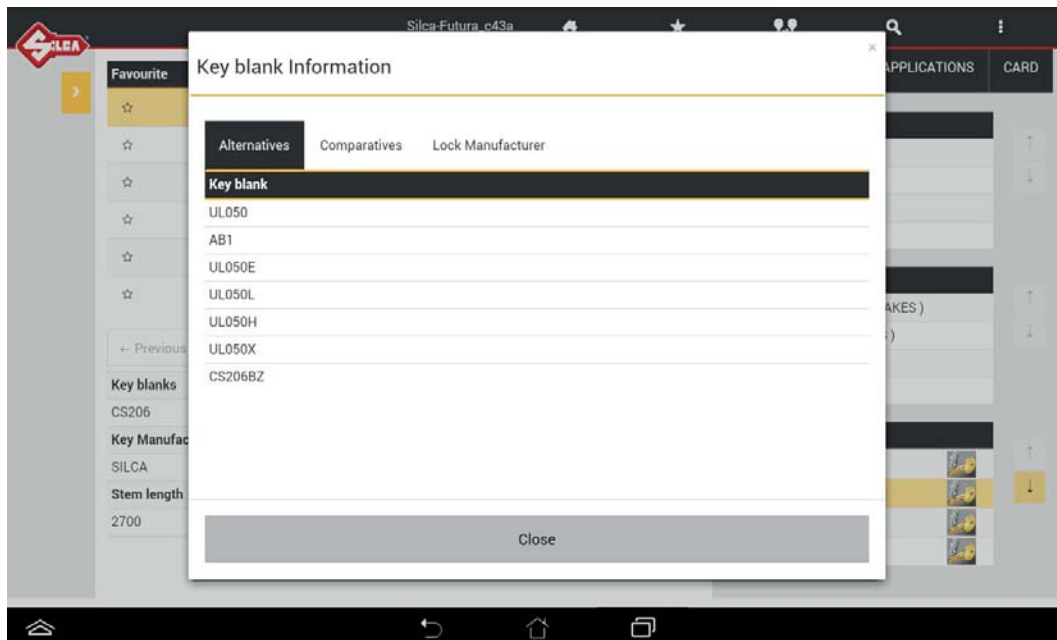

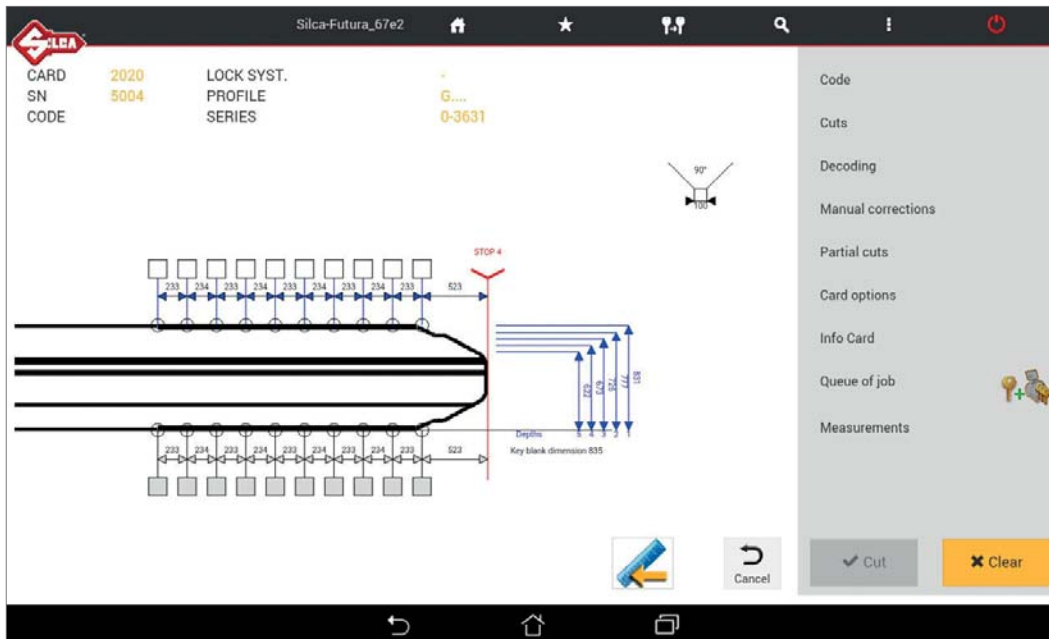

1.6 Using a CUTTING DATA CARD

Example:



The screen shows all the technical details relating to the selected cutting card (e.g. **Card, SN, Profile, Series, Spaces, Depth, Cutting angle**).

Tap the  Cancel key to go back to the previous screen.

Tap  to edit the way to view depths on the card:

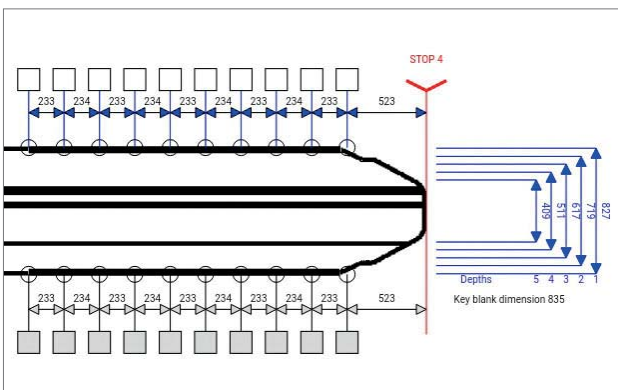

Fig. 1

Depths referring to the “key axis”

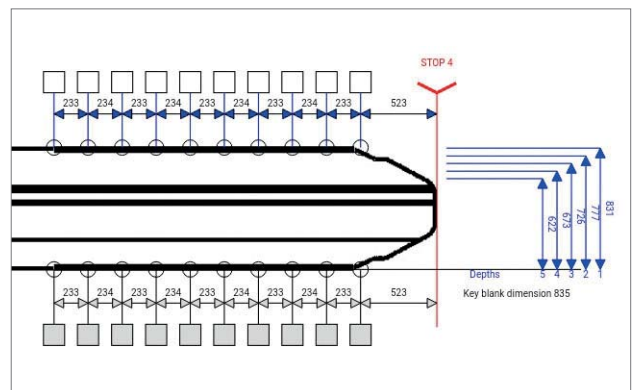

Fig. 2

Depths referring to “key back”
(i.e. the plate/bottom of the clamp)

Note: this function is only available for two sided symmetrical keys (standard and vehicles).

The list on the right contains the functions listed below:

- **CODE:** enter the indirect code for cutting the key.
- **CUTS:** this function is used to enter direct cuts.

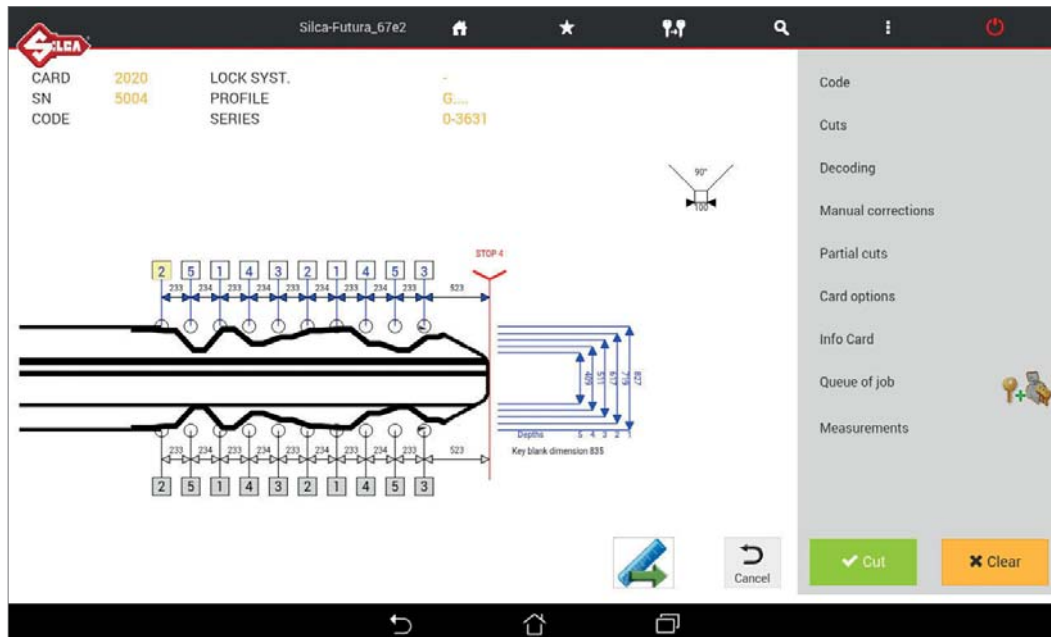

- **QUEUE OF JOB:** If the cut is filled and correct you can save your job in “Queue of Job” by tapping the following icon  (the job can then be done afterwards).

Tap on “Queue of Job” to display the list of jobs available.

- **DECODING:** used to decode the cuts on the original key.

ATTENTION: make sure the key to be decoded is clean.

Tap “Decoding”: information appears regarding the position of the key in the clamp.

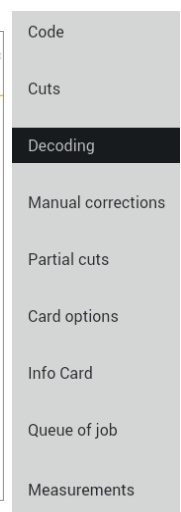
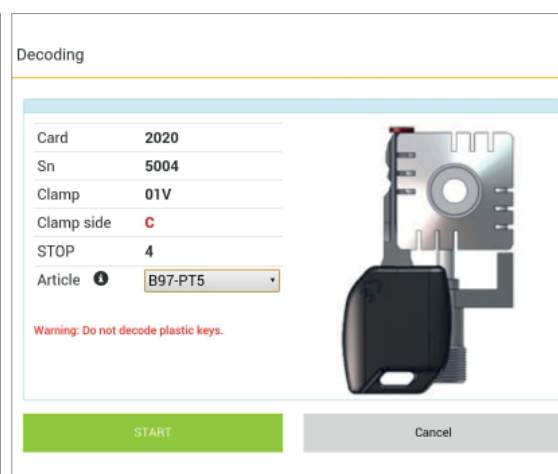
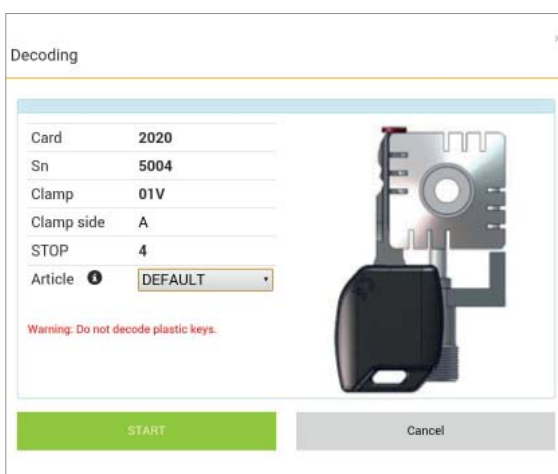

SELECT ARTICLE: to solve installation difficulties encountered with symmetrical vehicle keys on side A or B of the standard clamp, the user may select the key blank before decoding the key. In this way the machine will indicate the best side of the clamp (C or D) on which to fit the key and can run the decoding operation successfully.

To continue tap START and perform the operations described on the screen. At the end of the operation tap OK.

To view the decoded measurements and the measurements read on the key, tap “Decoded Values” on the bottom of the screen.

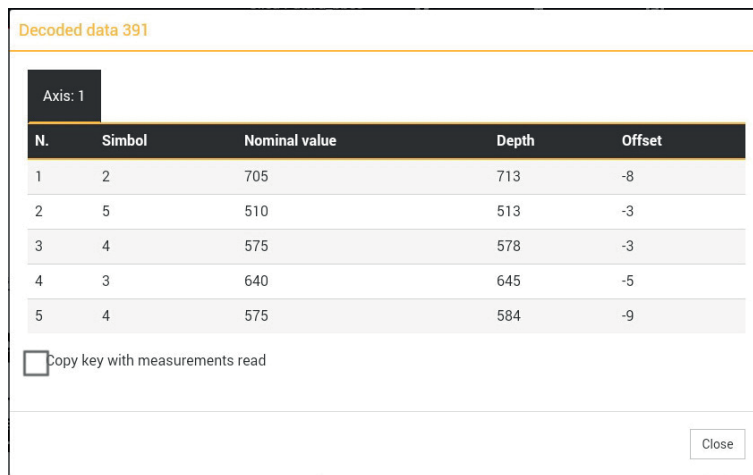

Decoded data 391

Axis: 1

N.	Symbol	Nominal value	Depth	Offset
1	2	705	713	-8
2	5	510	513	-3
3	4	575	578	-3
4	3	640	645	-5
5	4	575	584	-9

Copy key with measurements read

Close

Then tap “CUT” to cut the key using the combination provided by the previous operation.

Copy key with measurements read: after decoding a key the cuts can be verified and compared to the keys original cuts. If the cuts “Offset” values are significant, it’s possible to cut the key by using the measurements just read (not the keys original cuts nominal values that are in the card) by inserting a check “flag” in the appropriate box.

NOTE: when decoding standard keys, you must use the clamp side designated by the software as well as the stop position designated in order to decode the key properly. Use of other clamp positions or stop positions will result in a misread key. Once decoded, should you receive the message “key blank not allowed” or “bad permutation”, the key may not have been positioned properly. As a result the software will not recognize the key blank or the depths read will not correspond with any of the codes in the code series database. If you are sure that the proper card and key blank were used, reposition your key and try again.

- **MANUAL CORRECTIONS:** to enter manual adjustments in the relative fields for X axis and Y axis, activate the “Use corrections” flag, tap “Save” and then “Close”.

Adjustments: from -30 to +30 hundredths of mm (+/- 118 thousandths of an inch)

Close the window after it has shown an OK message.

An icon  indicates when the manual adjustment is active.

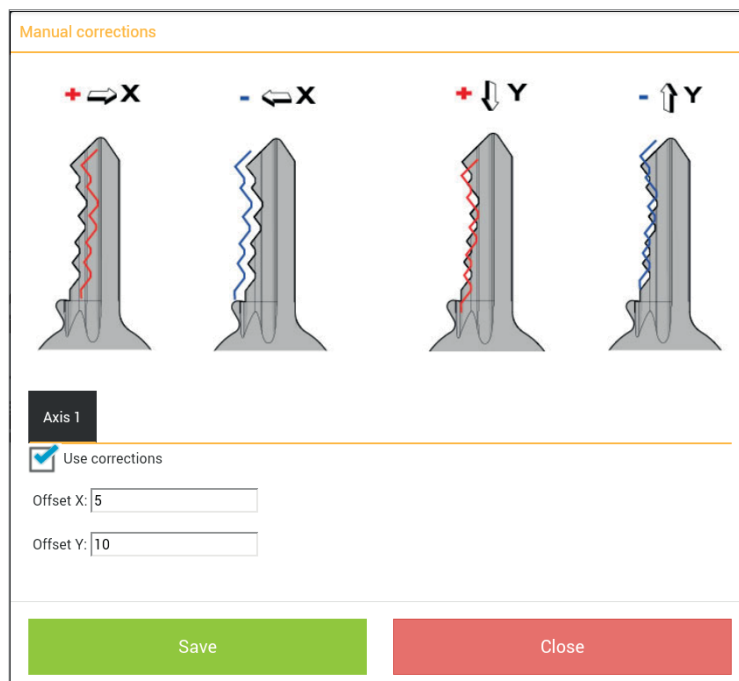

Code
Cuts
Decoding
Manual corrections
Partial cuts
Card options
Info Card
Queue of job
Measurements

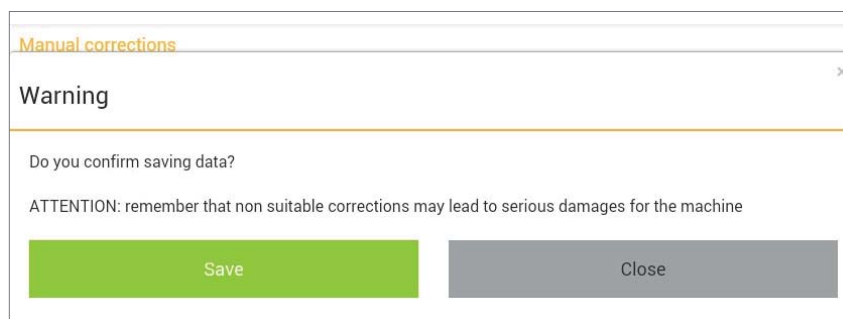

Confirm with “Save”.

- **PARTIAL CUTS:** used to make a search for correspondence with the code table (if applicable): enter the known cuts and tap “Search”.

Partial Cuts

Symbols

Axis	Permutation
1	5 2 3

Code	Quantity	Axis 1
BC782	1	5; 2; 3; 1; 1
BC783	1	5; 2; 3; 1; 2
BC784	1	5; 2; 3; 1; 3
BC785	1	5; 2; 3; 1; 4

- Code
- Cuts
- Decoding
- Manual corrections
- Partial cuts**
- Card options
- Info Card
- Queue of job
- Measurements

Cutting tree: function accessible only from “Partial cuts” and enabled only for Data cards/Series with code tables available. Tap the “Cutting Tree” key to continue.

Cutting Tree

N° key blanks required: **4**
Codes selected: **Key n° 1**

Code	Cuts
Key n° 1	
BC782	52311
BC783	52312
BC784	52313
BC785	52314
BC789	52324
BC790	52325
BC795	52335
BC796	52336
BC802	52346
BC803	52347
BC853	52357
BC858	52367
Key n° 2	
BC786	52321

- The list of keys shown in the cutting tree coincides with the list of keys shown in the “Partial cuts” window; however, here the keys are listed according to Groups, Code and Cuts in order to reduce to a minimum the number of key blanks to be used.
- The box at the top of the screen shows the maximum number of key blanks to be used for all the possible cut combinations listed.
- Each Group needs a new key blank to cover all the cut combinations it lists (work down from top). Select the group and/or single code and tap the QUEUE key to place them in the job queue.
- Tap Close, OK, and then Queue of Job.
- The jobs must be carried out in progressive order, starting from the key with the shallowest cuts to those with deeper cuts.

• CARD OPTIONS

Card options

Axis 1

Cut Type	M_NORMALE_FLAT_LFD ▾
Cutter	01F ▾
Clamp	01V ▾
Key blank dimension	840

- Code
- Cuts
- Decoding
- Manual corrections
- Partial cuts
- Card options**
- Info Card
- Queue of job
- Measurements

Cut type: alternative cutting methods can be chosen from Flat, Track, Normal, Normal Easy;

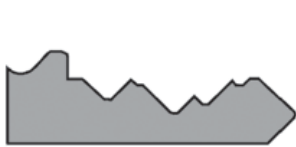

NORMAL (M_NORMALE_FLAT_LFD)

For conventional car and door keys.



FLAT (M_PIANO_FLAT_LFD)

Mainly used for car keys where the cut edges are rounded to facilitate the movement of the blades when the key is put into the lock.



LASER (M_LASER_FLAT_LFD)

Conjunction of the cutting angles is determined automatically by the machine, allowing cuts to be made with variable angles; this facilitates the smooth entry of the key into the lock, prolonging the working life of the key.



NORMAL EASY (M_EASY_FLAT_LFD)

Concerns traditional automotive and door lock keys, the edges of the cuts are removed (when possible) by a defined value of around 30 hundredths of a millimeter. Likewise even for the keys tip.

Key blank dimension: used with the “Use any clamp” function.

With keys that have SYMMETRIC CUTS the following window would appear:

Card options

Axis 1

Cut Type: M_LASER_FLAT_LFD

Cutter: 01F

Clamp: 01V

Key blank dimension: 810

Ok

- Code
- Cuts
- Decoding
- Manual corrections
- Partial cuts
- Card options**
- Info Card
- Queue of job
- Measurements

- **INFO CARD:** views information about the clamp, side and stop to be used, cutter and key blank.

Tap the relevant icons ⓘ to see images and part code.

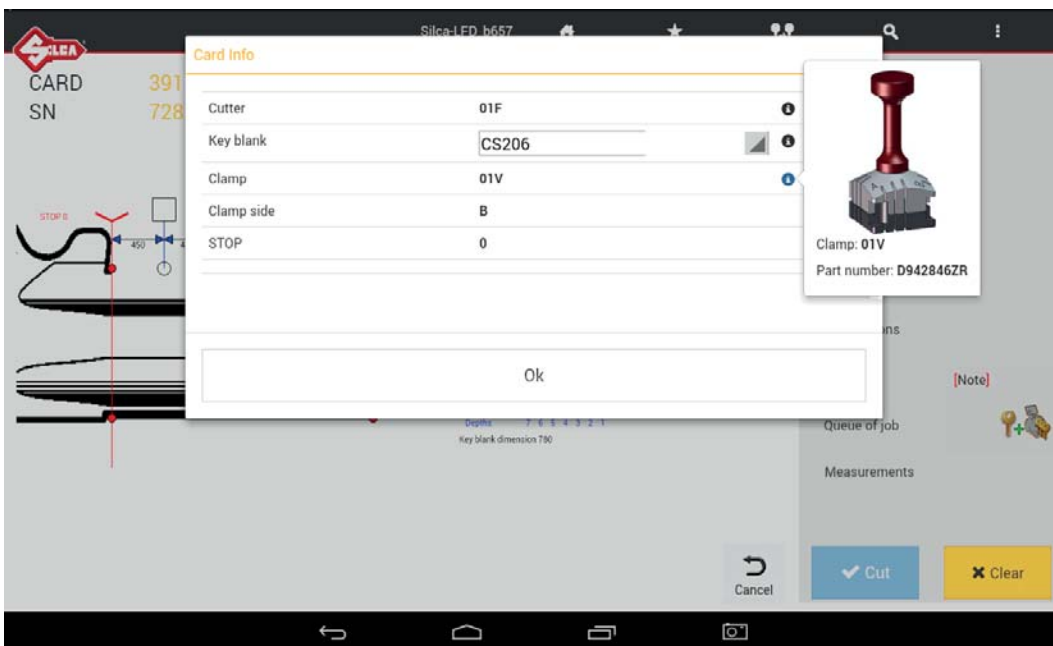

- Code
- Cuts
- Decoding
- Manual corrections
- Partial cuts
- Card options
- Info Card**
- Queue of job
- Measurements

- **[Note]:** tap “Note” (when shown) to view data card notes, i.e. further specific information relating to the position of the key or an accessory, etc.

- **MEASUREMENTS:** view information regarding the measurements of SPACES and DEPTH on the card.

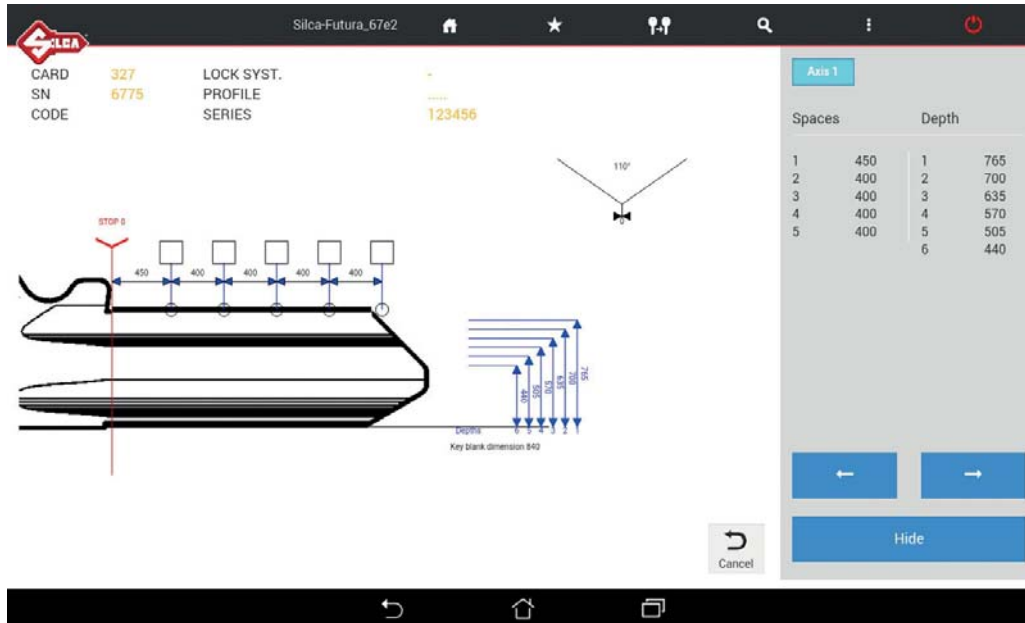

- Code
- Cuts
- Decoding
- Manual corrections
- Partial cuts
- Card options
- Info Card
- Queue of job
- Measurements**

1.7 CUTTING STANDARD flat keys (cylinder and vehicle)

To make a cut on the key, tap CUT  : information is shown about the position of the key in the clamp.

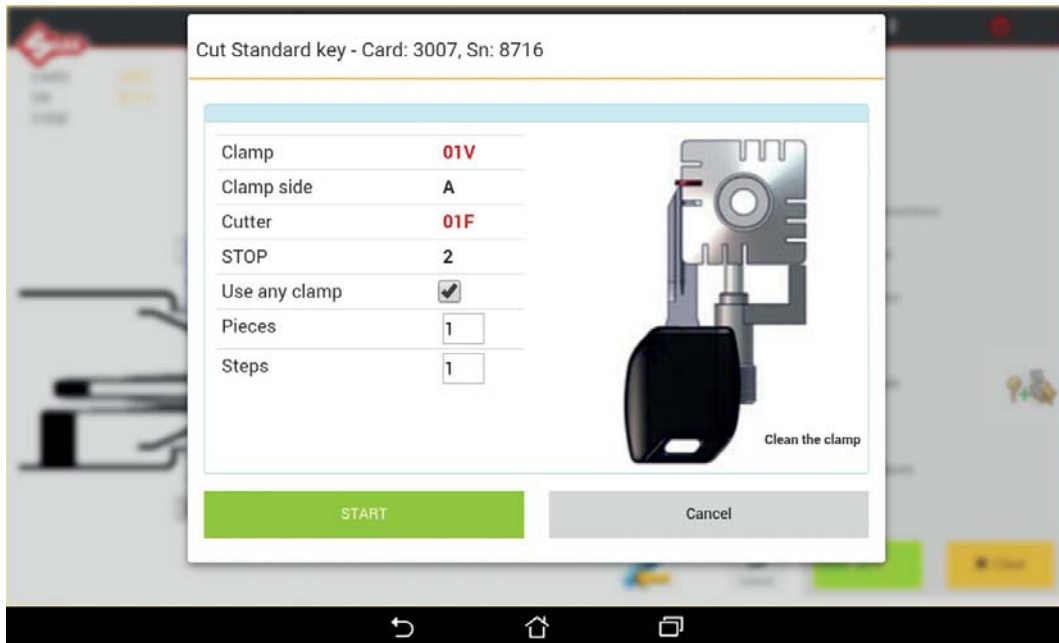

The following can be set:

Use any clamp: if this function is enabled the key to be cut can be positioned on a clamp side different from default. The function is used to acquire the measurement of the key blank (stem width) in order to adapt cuts to the key blank being used. It is applied automatically only to keys with double symmetrical sides.

ATTENTION: option valid for **CUTTING** only (**NOT DECODING**).

NOTE: activating the “Use any clamp” allows the user to clamp the key in any jaw position (i.e. clamping the keys profile on side C or D) when cutting a key by code. Regardless of the jaw position used, the stop position designated by the software must be used. This function is only available when cutting two symmetrical sided standard keys. When this function is enabled cuts cannot be repeated on a key already cut.

Pieces: indicates how many keys you wish to cut.

Steps: used to edit the default number of passes during key cutting (max +2). The value is memorised once it has been edited.

2 COPY BY ORIGINAL

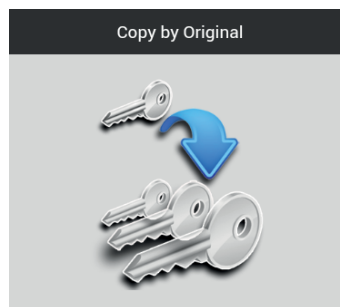

Tap **“Copy by Original”** to start the procedure for copying an original key using the laser reader as an optic reader device.

This operation can be used only for the types of keys cut on clamp 01V.

The “Copy” procedure is divided into two steps: first load the original key to be read into the clamp 01V, once the key has been read, remove the original and load the key blank to be cut.

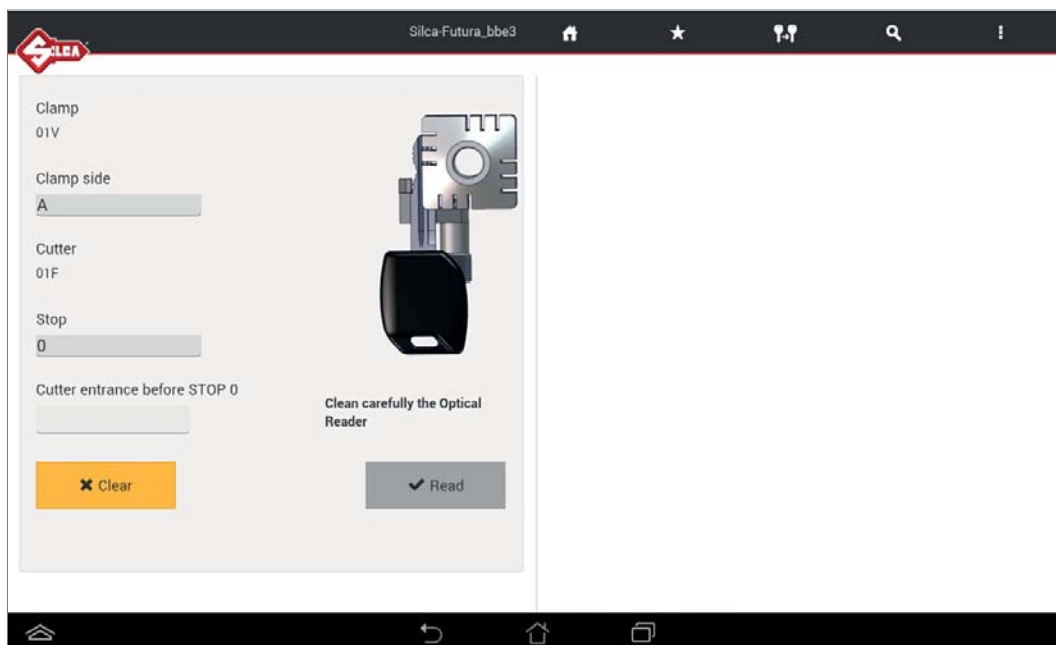

In the Left-hand Part of the screen:

- Select the clamp side (A-B-C-D) to be used for reading and cutting the key.
- Select the type of Stop involved (0-1-2-3-4)
 - in the case of Stop 0 the gauge is used to align the key stop
 - with Stops (1-2-3-4) a bar is used to align the stop with the key tip.
- The Distance field is used when the stop selected is 1-2-3-4 and there is an indication of the point at which the optic reader will start reading the original key. Normally this point equals Stop 0 which refers to the position of the gauge/key stop.

Range [0 / -400 hundredths of mm] => insert only NEGATIVE value.

NOTE: clean the optic reader carefully with the brush provided before starting the “Copy by Original” procedure.

When the key has been read, the following can be set:

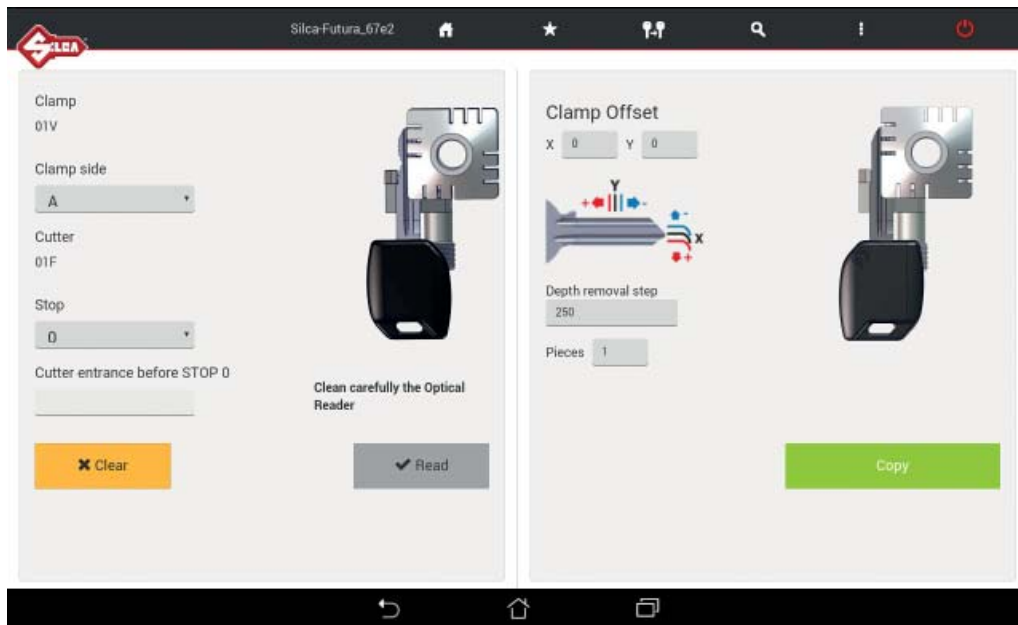

Manual adjustments

Manual adjustments can be made to Y and X only if strictly necessary.

Positive value of Y: move cut closer to stop.

Negative value of Y: move cut away from stop.

Positive value of X: lower the cut.

Negative value of X: raise the cut.

Adjustments admitted: -30 to +30 hundredths of a millimetre. Press "Save" to confirm.

Pieces: indicates how many keys will be cut.

Remove the key just read from the clamp and load the key blank to be cut, positioning with the same Stop and Clamp Side used during the reading process.

Tap "Copy" to start key cutting.

NOTE: the Copy by Original function will cut the key exactly as read if no manual adjustments are made. If you are copying a worn key and do not make manual adjustments, the cut key will be an exact duplicate of the original worn key. To copy a worn key back to OEM specifications you should use the "Search" function to identify the card or code series used for the original key. Once the proper card is opened, select "Decoding" on the right side of the card menu. This will measure the cuts based on the depth data used by the OEM and the software will make adjustments to the depths measured and cut the duplicate key back to OEM specifications.

3 FAVORITE'S

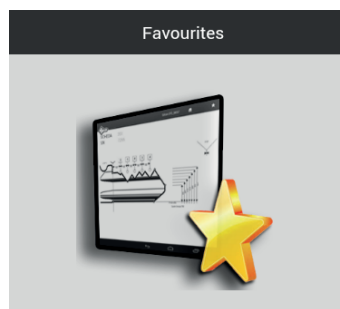

The FAVORITES menu contains the data cards that have been selected in the Search menu (Standard keys, Vehicle keys). Saving data cards to the favorites menu will eliminate the time spent searching for frequently used cards.

For each data card a description can be written in the special field in the “User Note” column.

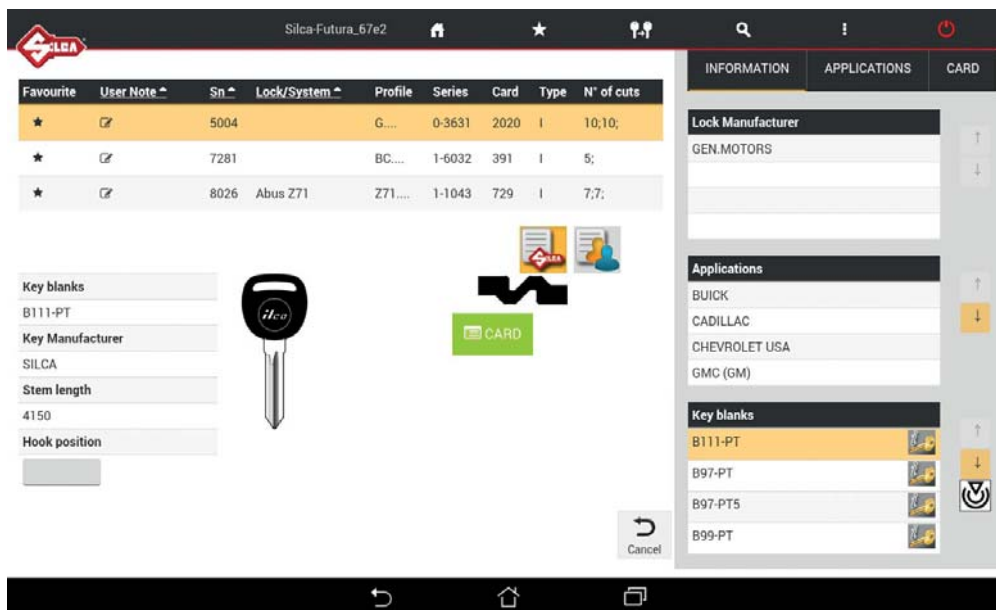

To select data cards to be included in the Favorite's menu tap the star symbol ☆ in the first left-hand column of the Search menu; the symbol will be highlighted in black.

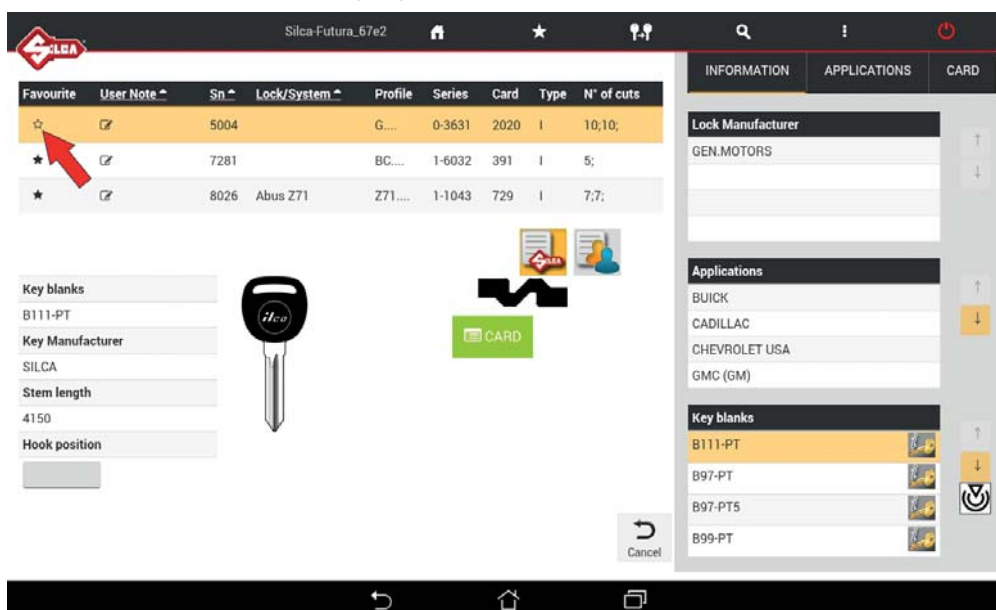



To remove a data card in the Favorite's menu, tap the relevant star symbol, which will go back to white.

4 QUEUE OF JOBS

The “Queue of Jobs” collects all the jobs (the keys) the user prefers to do later. See on page 15 how to move a job in this “Queue of Jobs”.

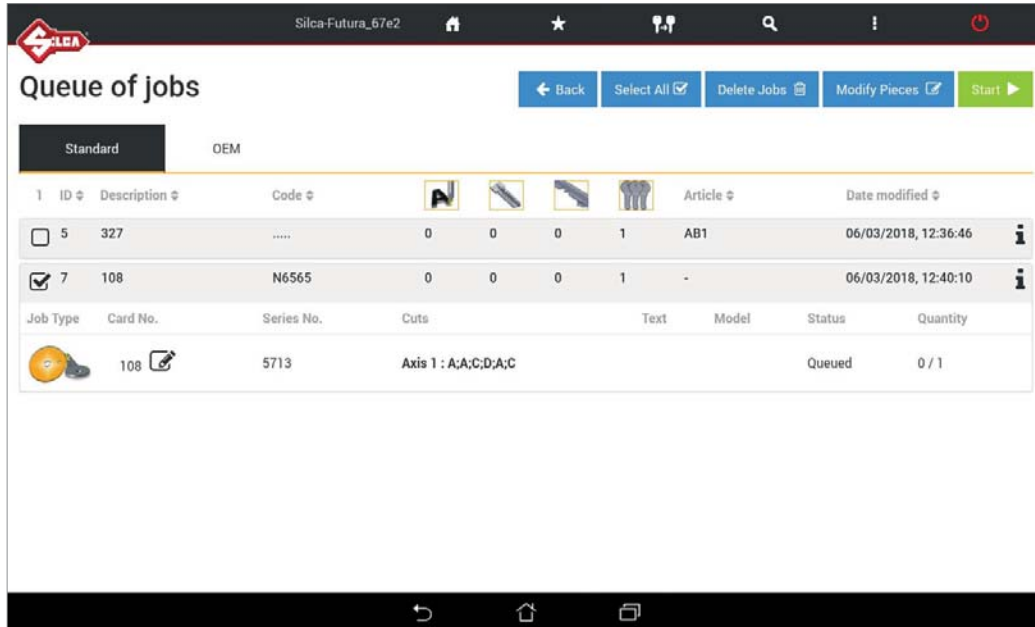
4.1 “STANDARD” QUEUE OF JOBS



- Select one or more jobs using the “Select All” button, or tap the  box.
- To see other job details, tap the single row.
- To delete the selected jobs, tap “Delete Jobs”.
- To edit the number of keys to be cut in the selected jobs, tap “Modify Pieces”.
- To start cutting the selected jobs, tap “Start”.

ICON LEGEND



Total number of keys to be cut



Number of STANDARD cuts already made



Identifies STANDARD cuts



Extra information

5 OPTIONS



Options contains the following menus:

- **Info**
- **Calibration**
- **Settings**
- **Machine maintenance**
- **Upgrades**
- **Backup/Restore**
- **User series**
- **Code Maker (optional - see ch.9)**

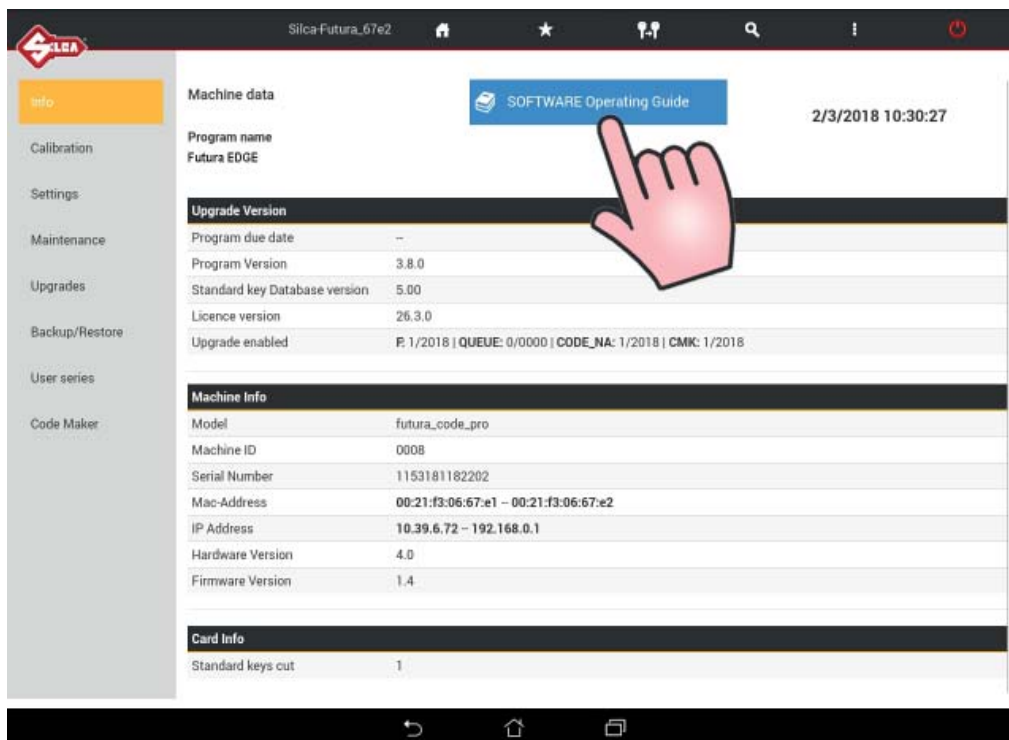

5.1 INFO

This window shows the main data for the Futura Edge machine (e.g. SW update version, serial number, number of keys cut, etc.).

Tap the appropriate icon to view the “SOFTWARE OPERATING GUIDE”.

5.2 CALIBRATION

Calibration includes:

- **Clamp Standard keys**
- **Standard key Adapter**

5.2.1 STANDARD key clamp calibration

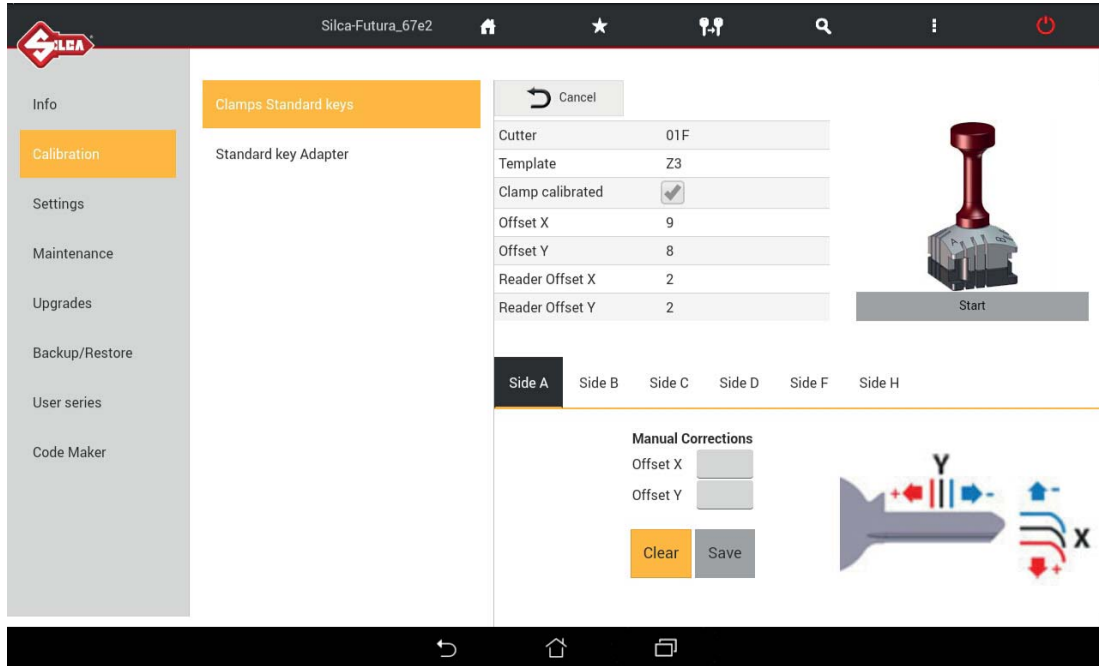

Tap **START** to begin calibration.
Fit template Z3 into the 01V clamp, as illustrated.

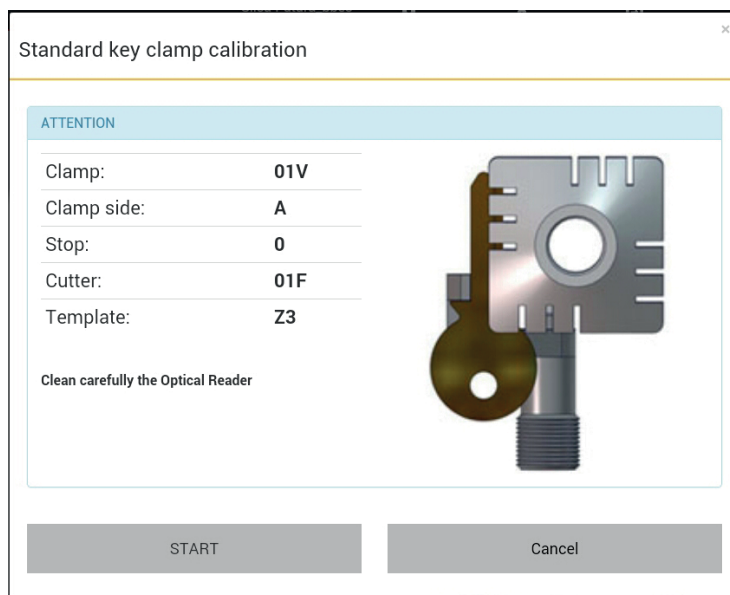

When the message “Clean carefully the Optic Reader and key without removing it” appears, lift the safety shield and carry out the required operations.

Close the safety shield and press START to continue.

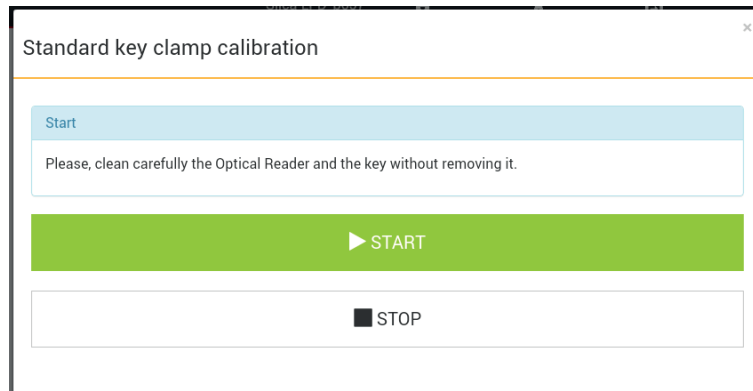

At the end of the operation you are required to save the data entered.

Tap “Yes” to confirm.

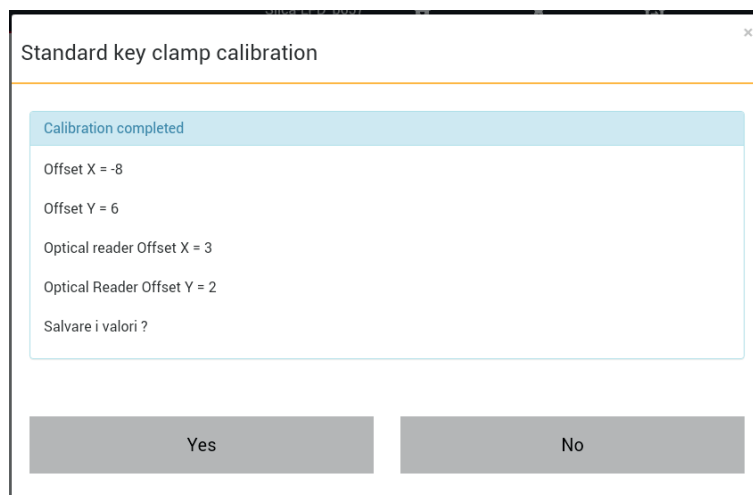

The 01V clamp is calibrated only for Side A.

Only Manual corrections of Y (spaces) e X (depth) can be entered on sides B, C and D.

Positive value of Y: takes cut closer to stop.

Negative value of Y: takes cut away from stop.

Positive value of X: lowers the cut from the axis.

Negative value of X: raises the cut from the axis.

Adjustments: from -30 to +30 hundredths of mm (+/- 118 thousandths of an inch).

Tap “Save” to confirm.

5.2.2 STANDARD key Adapter calibration

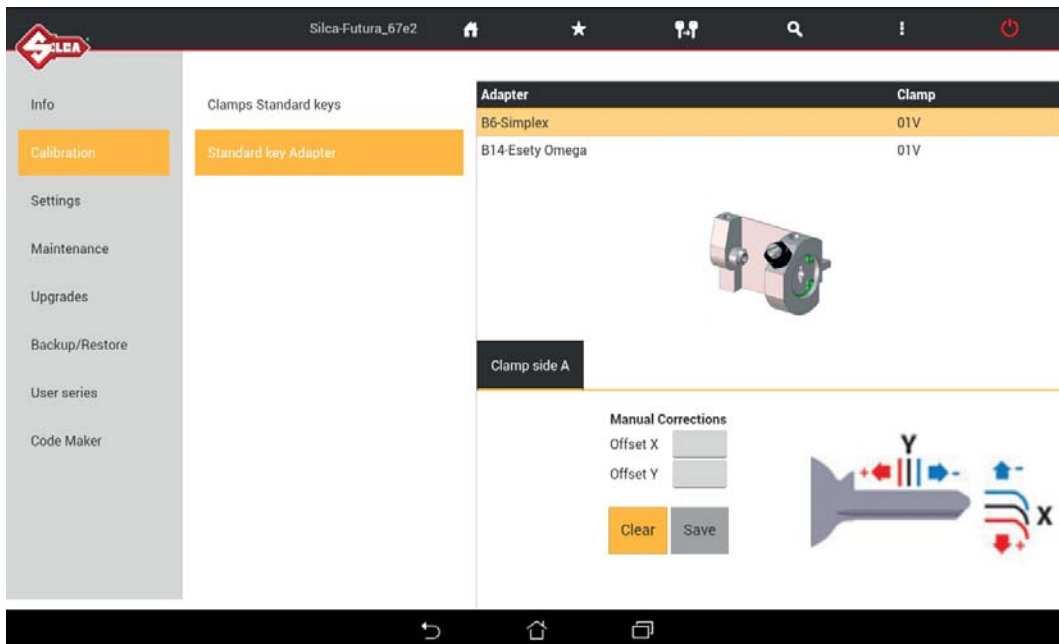

Adjustments to X (spaces) and Y (depths) can be made manually.

Positive value of Y: takes cut closer to stop.

Negative value of Y: takes cut away from stop.

Positive value of X: lowers the cut from the axis.

Negative value of X: raises the cut from the axis.

Adjustments: from -30 to +30 hundredths of mm (+/- 118 thousandths of an inch). Tap "Save" to confirm.

5.3 SETTINGS

The Settings menu contains:

- **Zero-point Calibration (STANDARD key)**
- **Options**
- **Network setting**

5.3.1 Zero-point Calibration (STANDARD key)

Tap START and follow the instructions on the screen.

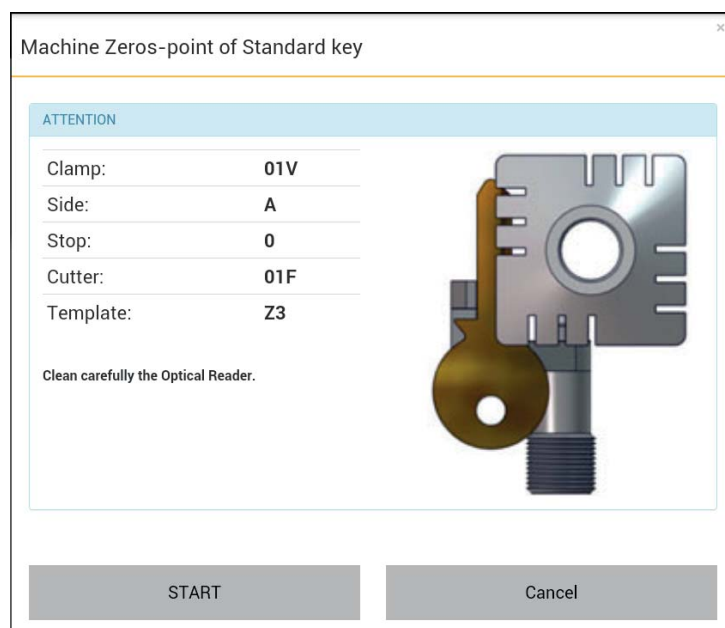
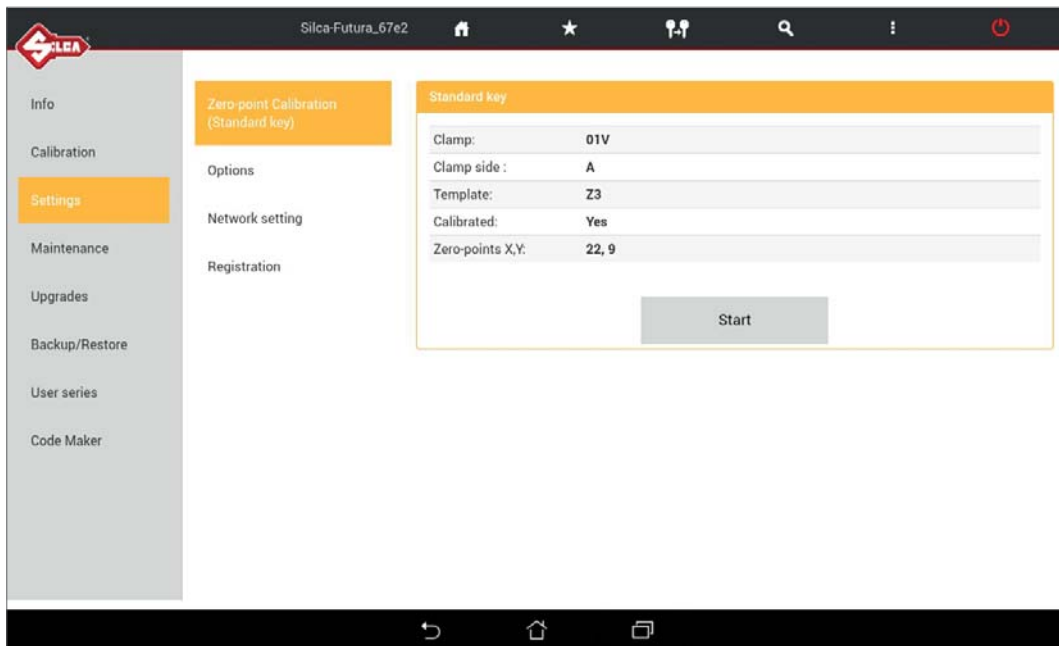

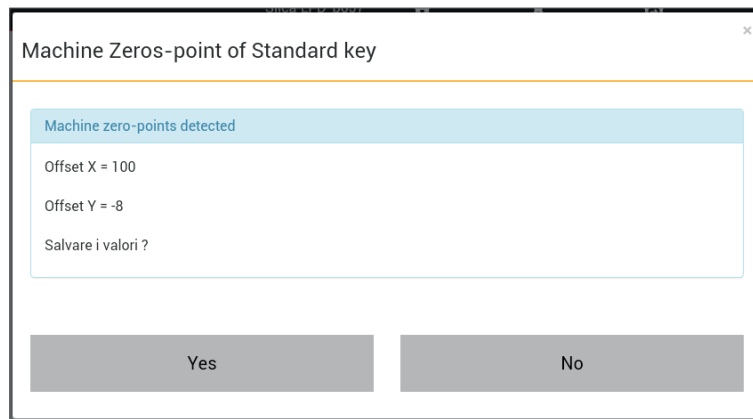
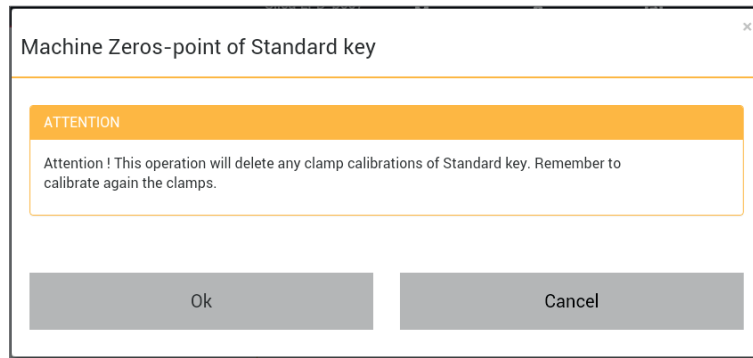

At the end of the operation you are required to save the data entered.
Tap "Yes" to confirm.

5.3.2 Options

The Options menu contains:

- **General**
- **Preferences STANDARD key**

5.3.2.a General

The following parameters can be modified:

- **Measurement Unit** (millimeters or inches)

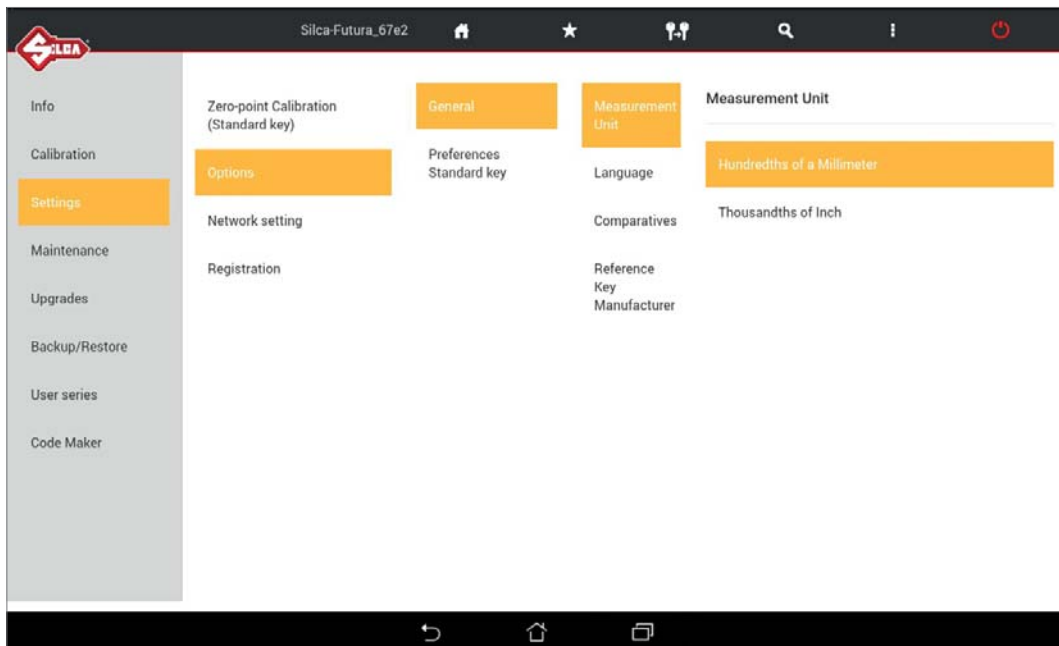

- **Language**

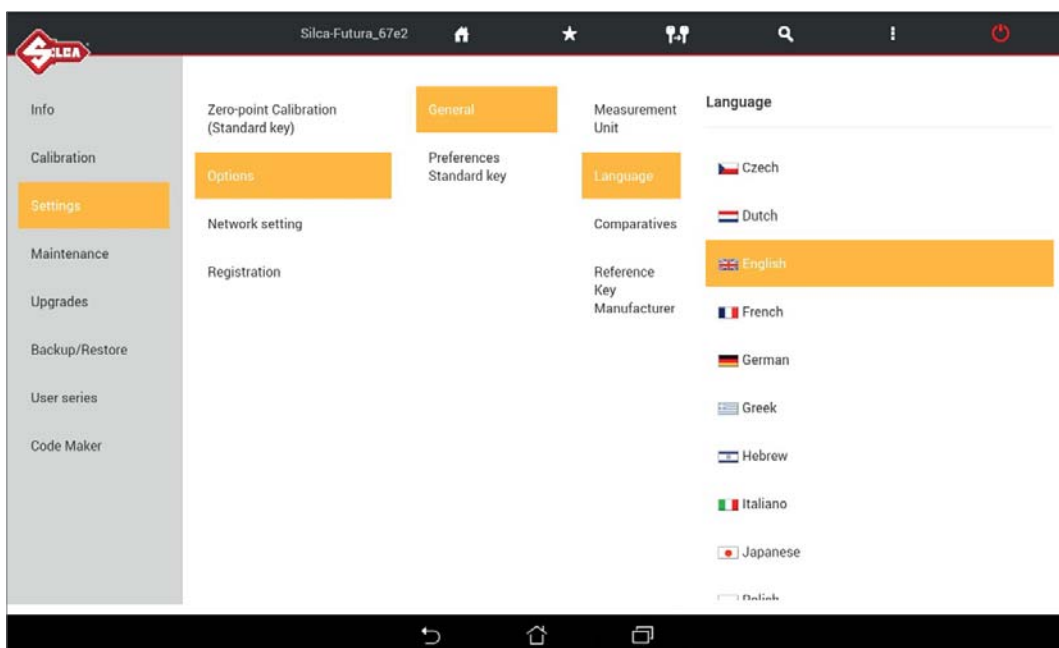

- **Comparatives** (comparative brands to visualize for key research)

It's possible to pick and/or unpick brands that can be seen after a research of comparatives articles. In the comparative list Silca is activated by default.

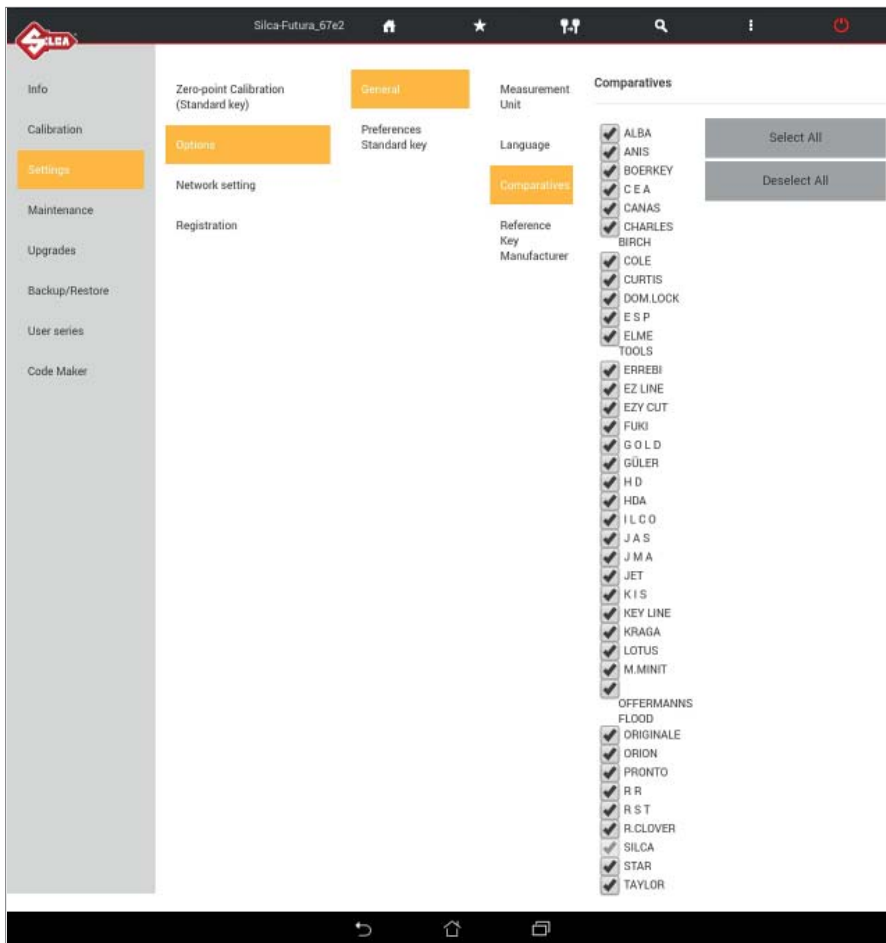

- **Reference Key Manufacturer**

After a key search... the key to be duplicated will always (with exception*) be the Silca reference by default. ILCO can also be set as a reference by default.

* keys that are not produced by Silca (copyright - obsolete - new keys)

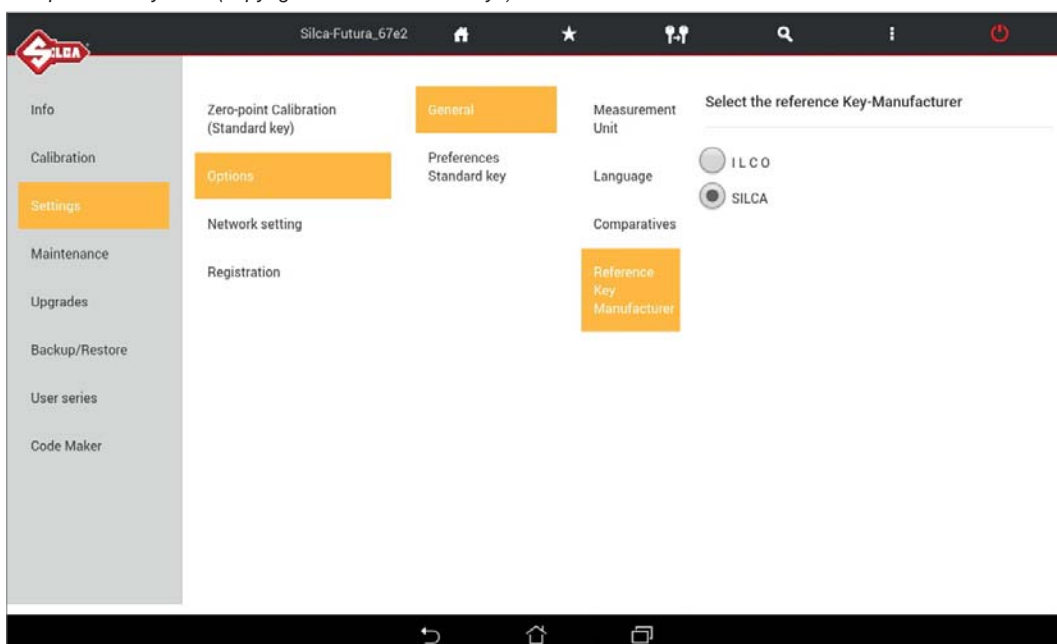

5.3.2.b Preferences STANDARD key

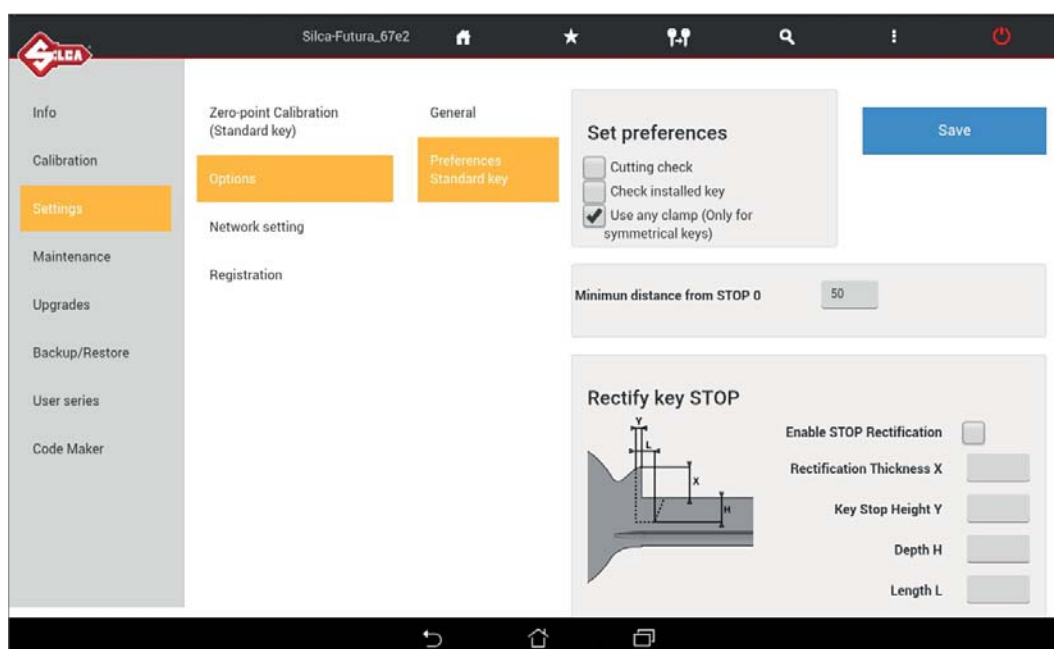

Cutting check: in simple terms ...MACS protection (Maximum Adjacent Cut Specification). When enabled this function prevents the machine from accepting user input of direct cuts that would result in a combination of cuts not included in the data cards.

Check installed key: when enabled this function checks whether the second side of the key is properly aligned in the clamp. Any alignment errors (taper) will be offset. This function is used only for keys with cuts on both sides.

Use any clamp: if this function is enabled the key to be cut can be positioned on a clamp side different from default. The function is used to acquire the measurement of the key blank (stem width) in order to adapt cuts to the key blank being used. It is applied automatically only to keys with double symmetrical sides.

ATTENTION: option valid for **CUTTING** only (**NOT DECODING**).

Rectify key STOP: when enabled adjusts the key stop as per instructions on the screen.

Minimum distance from stop: the range [50-90] (hundredths of a millimeter); 197-354 thousandths of an Inch)

Interval for parameters involved (in hundredths of a millimeter):

X	0 - 99
Y	0 - 400
H	0 - 400
L	0 - 500

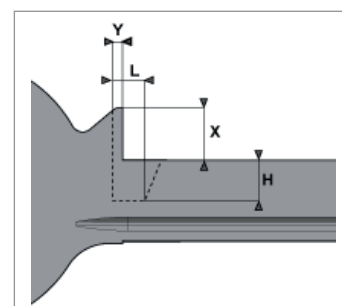

5.3.3 USE

The machine can be set up in one of the 4 modes below:

- 1) **ACCESS POINT** through Wi-Fi (factory configuration)
- 2) **ETHERNET** with connection to LAN and router (to connect the machine to the internet)
- 3) **TETHERING USB** (for connecting tablet and machine via cable)
- 4) **LOCAL NETWORK (LAN)** (to connect the machine to the internet)

MODE	ACCESS TO INTERNET	TABLET - MACHINE Connection 	Recommended
ACCESS POINT	NO	Wi-Fi	YES
ETHERNET with connection to LAN	YES via CABLE	Wi-Fi	YES
TETHERING USB	NO	USB cable	YES
LOCAL NETWORK	YES via Wi-Fi	Wi-Fi	-

5.3.3.a ACCESS POINT mode (Wi-Fi connection between machine and Tablet)

In this mode the Tablet connects directly to the machine.
The machine is set on this mode in our workshops.



Fig. 3

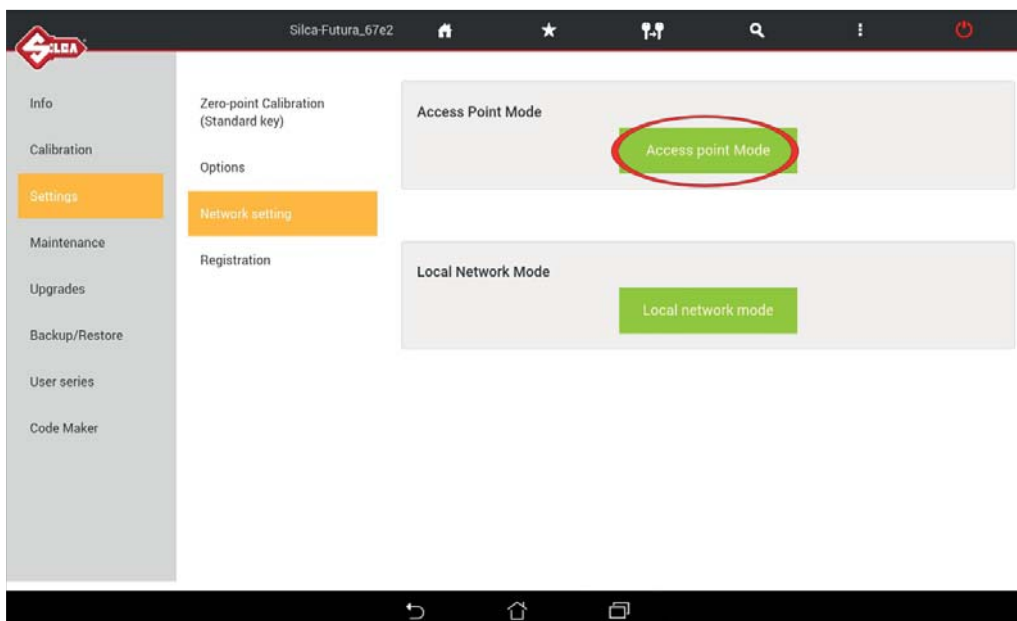

When the machine and Tablet are switched on the connection automatically activates in around two minutes; if not, check the Wi-Fi connection from your Tablet to see if the machine is included in the Wi-Fi networks that are found; the machine will appear as **Silca-Futura_....**

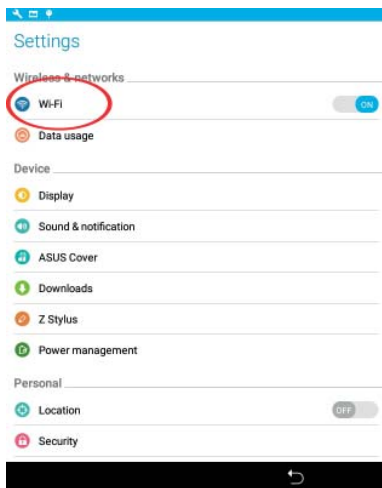

If it is not connected pick “Silca-Futura_...” and input the password which correspond to the machine serial number (made up of 13 numbers).

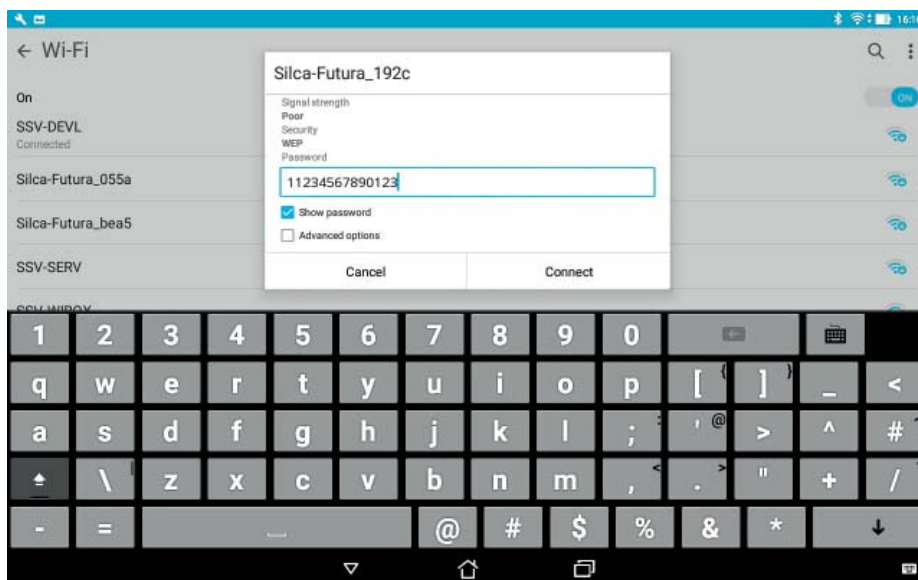

The option to change the Wi-Fi channel is used in cases when the (point to point) communication cannot be properly connected since there are too many devices tuned to the same channel. It also permits the user to adapt to the rules and restrictions of Wi-Fi channel use in their country. To change the channel one must first be connected, select the new channel and then reboot the machine.

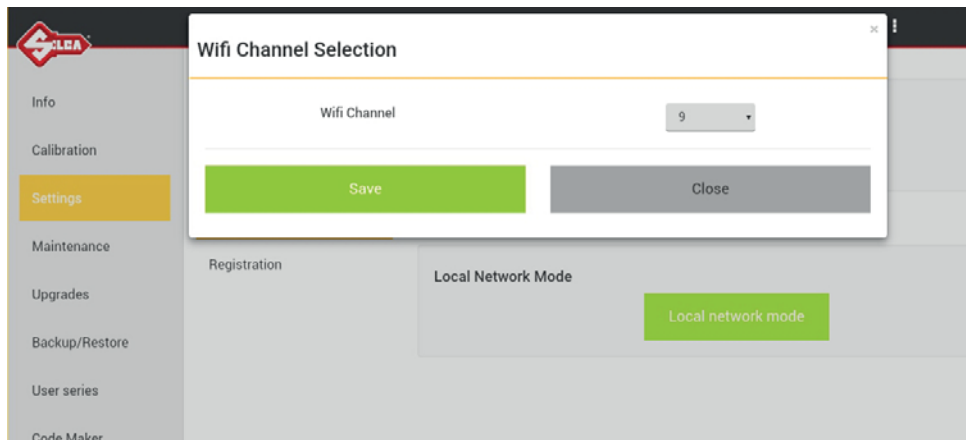

5.3.3.b ETHERNET with connection to LAN and router

To connect the Futura Edge machine to the internet through your LAN:

- Set the machine on ACCESS POINT and connect the tablet in Wi-Fi to the machine (factory configuration).
- Connect your LAN ethernet cable to the machine (Fig. 4).

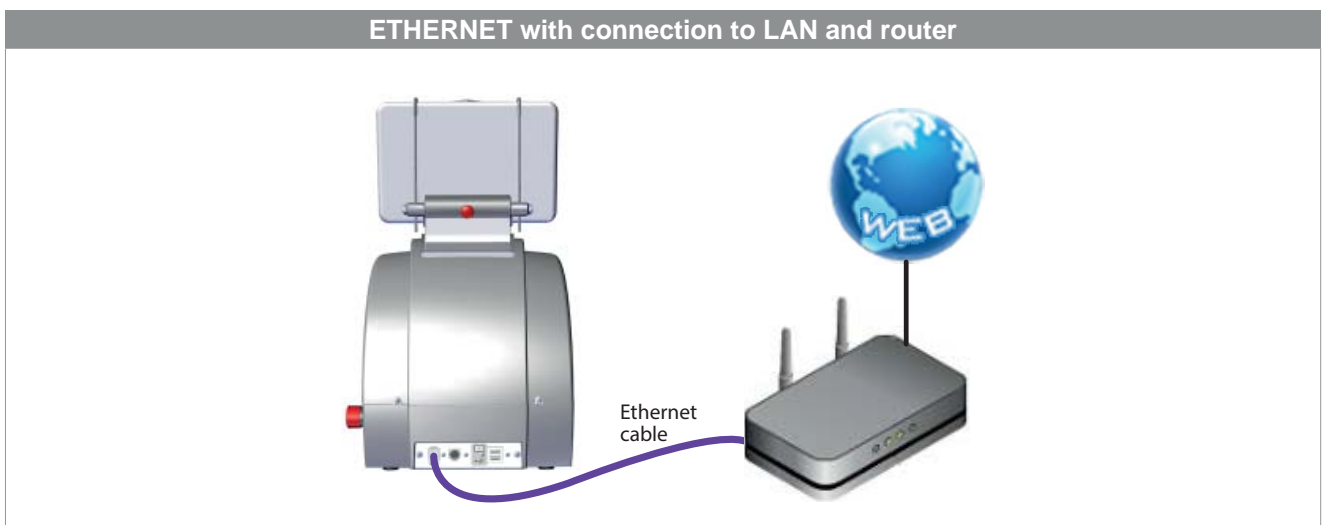

Fig. 4

5.3.3.c TETHERING USB mode

This method is used to connect the machine to a Tablet by means of a USB cable. Use the power cable provided with the Tablet.

Attention! This control is active and can be selected only if:

- the Tablet Wi-Fi network is disabled (OFF).
- the USB cable is connected to the Tablet and machine (Fig. 5).
- an Ethernet cable is not connected to the machine port.

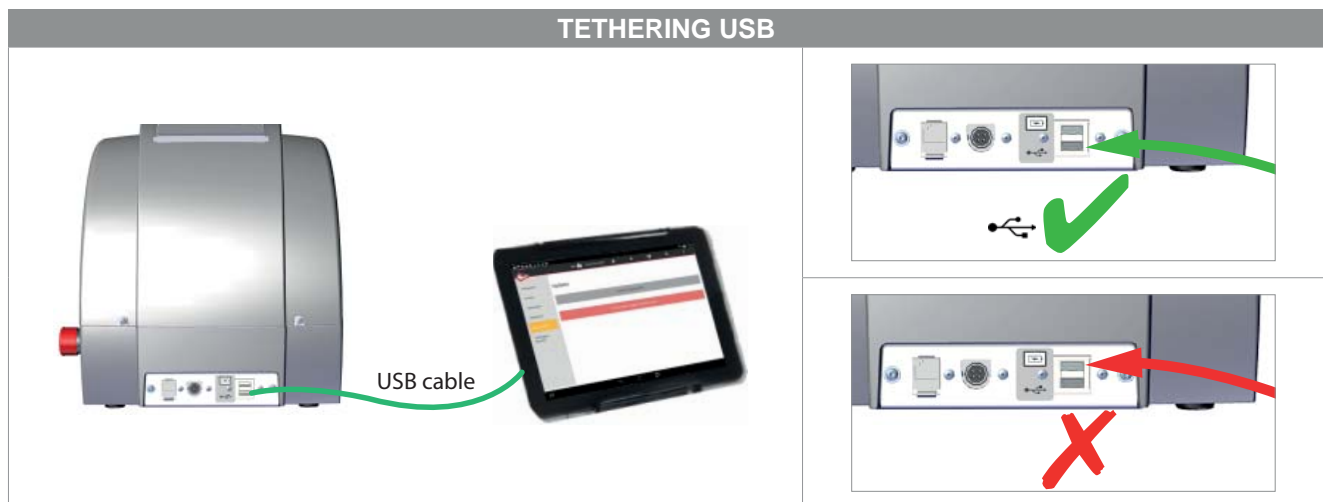

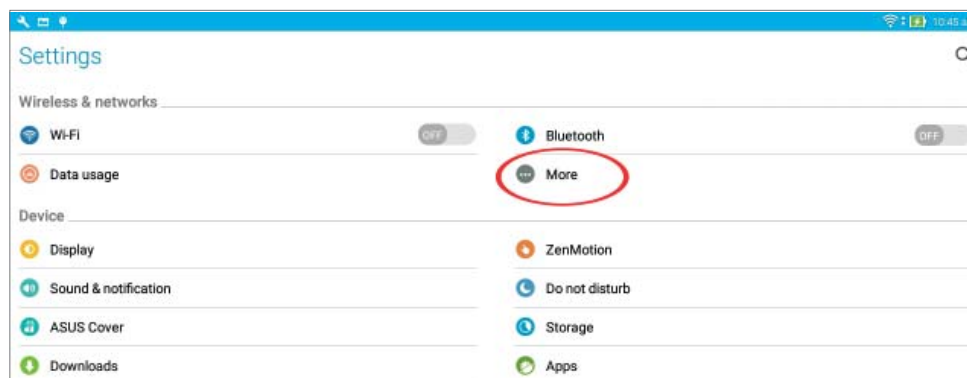

Fig. 5

- 1) Connect the USB cable to the machine and Tablet (Fig. 5).
- 2) Access “Settings”  on the Tablet.
- 3) Set “OFF” to disable the Wi-Fi.
- 4) In the Tablet “Settings” tap the “More...” icon and select the item “Tethering & Portable hotspot”.



- 5) Tick “USB Tethering” or select “ON” to enable.

When this item is enabled a green light on the machine will flash for a few seconds. It may take 10-20 seconds for this to happen.

Start the Silca Futura APP and open the drop-down menu.
Select "Connect to" to find the machine.

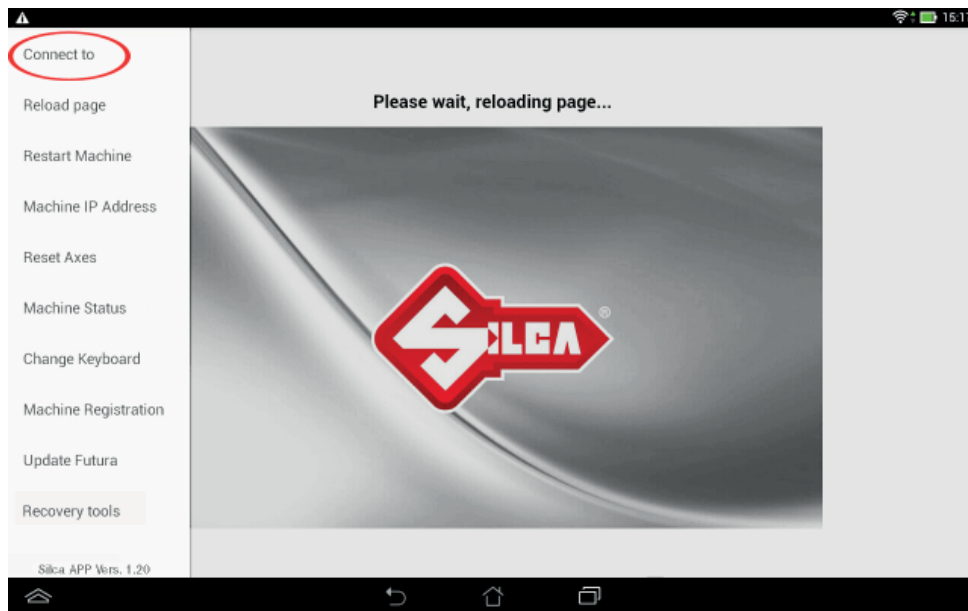

When the machine has been found, hit to select and establish connection.

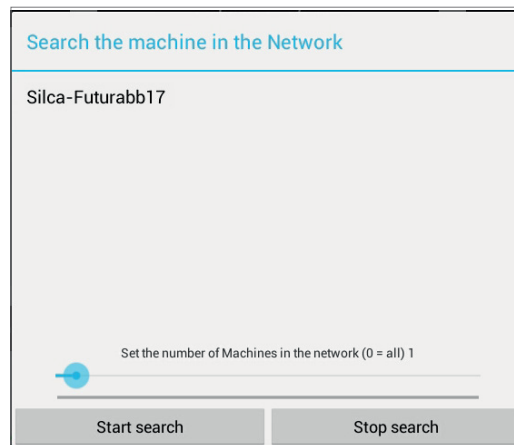

NOTE: if the Tablet and machine have been turned off, when turning on the USB connection must be made again, in the way described above, if you wish to work with the Tethering USB mode.

NOTE: when the machine-tablet connection has been made, if necessary you can re-boot the tablet Wi-Fi connection to connect to the internet.

5.3.3.d LOCAL NETWORK mode

This mode is useful to connect the tablet and machine, sharing the internet access provided by the router. If this is required we suggest in any case using the “Ethernet with connection to LAN” configuration, as described in Chapter 5.3.3.b as it performs better.



Fig. 6

To access this method of use, go to the Options > Settings menu, select “Network setting” and hit the LOCAL NETWORK mode icon.

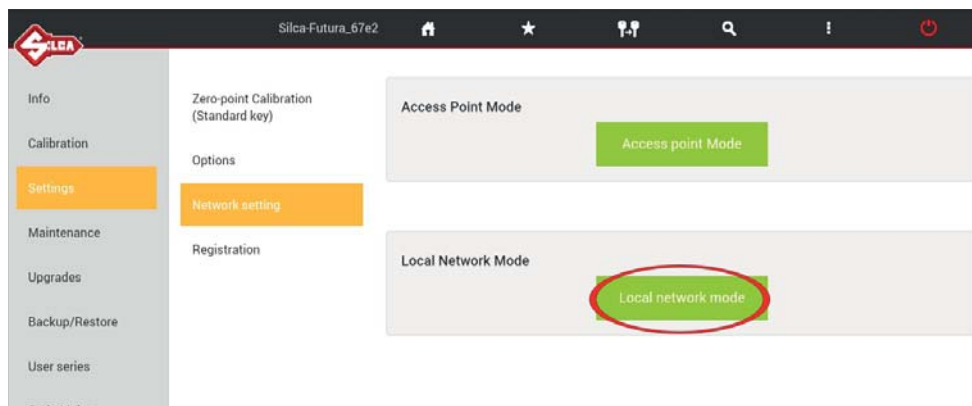

Perform the following operations to activate this method:

1) FUTURA EDGE CONNECTION TO A WI-FI ROUTER

Pick the network to which you want to connect by tapping the SSID field and then inserting the network’s password.

Tap “Save” to reboot the machine in Local Network. The machine should initially reboot with a flashing white and blue light, to then end with two flashing blue lights that indicate the connection to the local network was successful.

If the inserted password was incorrect the machine would reboot in ACCESS POINT mode with an intermitted flashing blue light.

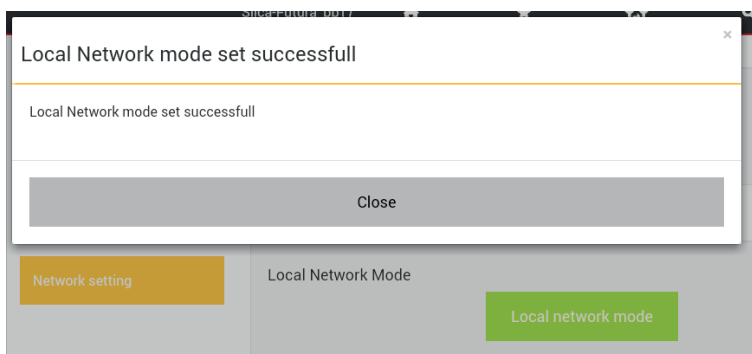
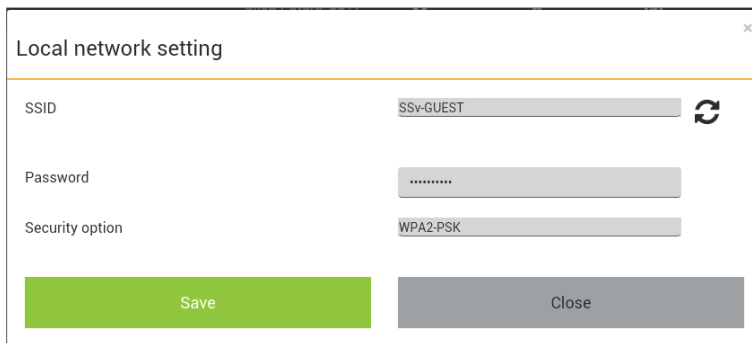
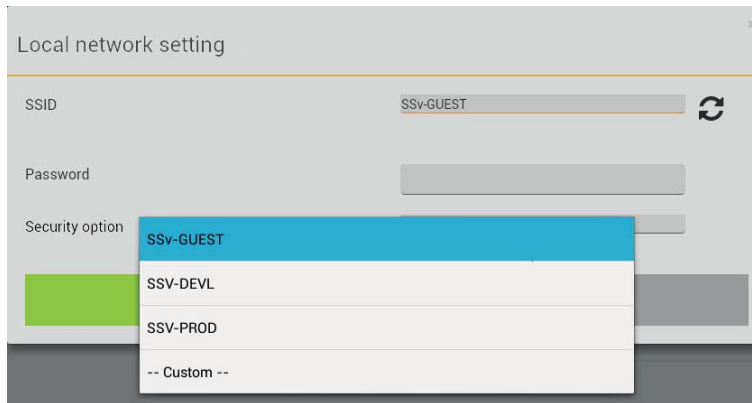

2) CONNECTING TABLET TO A WI-FI ROUTER

From the Tablet's "Settings" menu  tap on the desired network to connect.

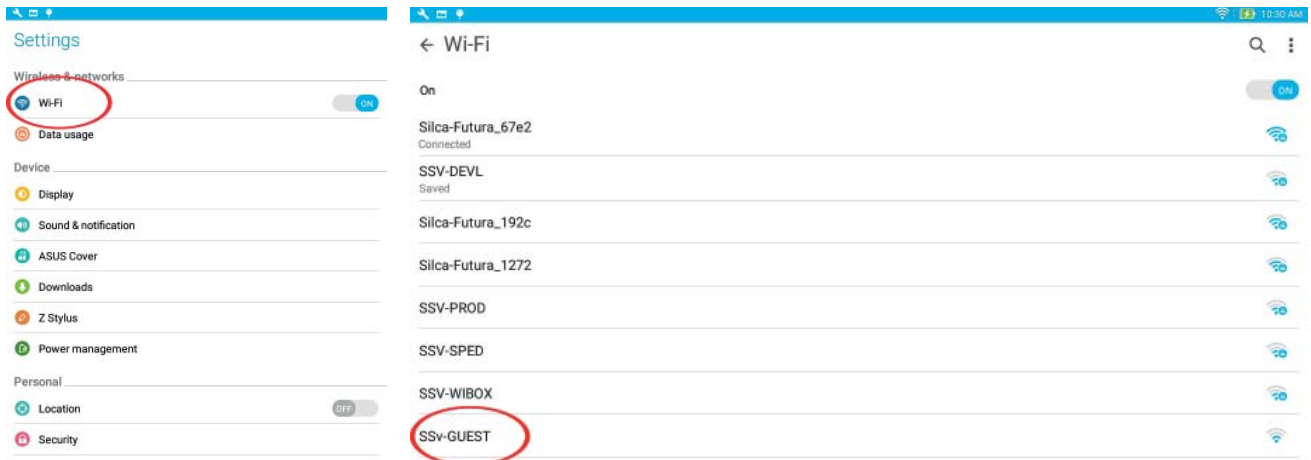

3) REBOOTING THE FUTURA'S APPS

Open the drop-down menu and select "Connect to".

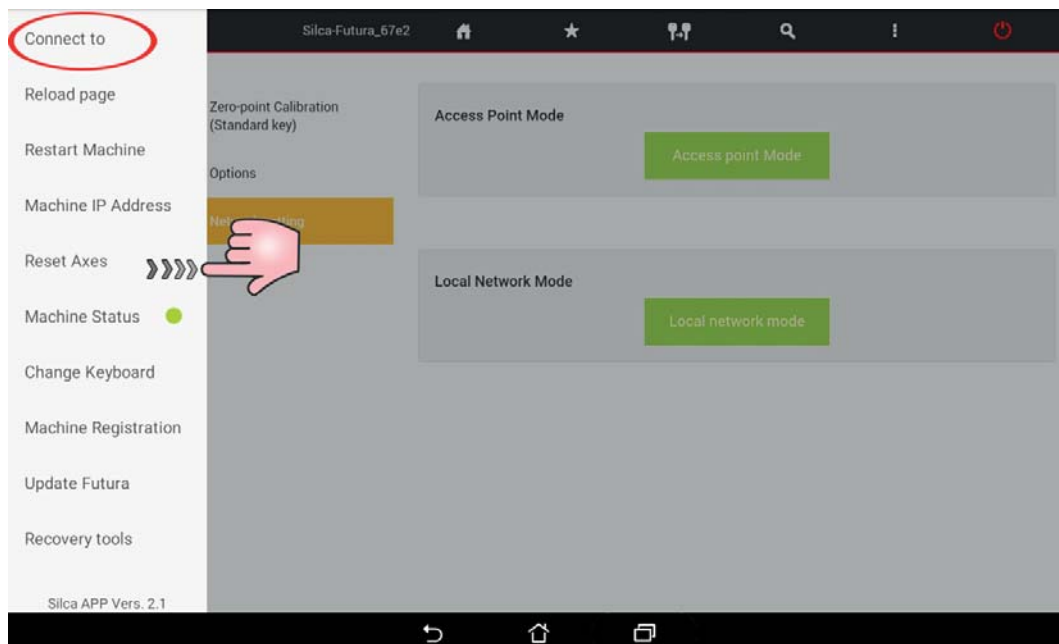

Tap on “Start Search” in the following window.

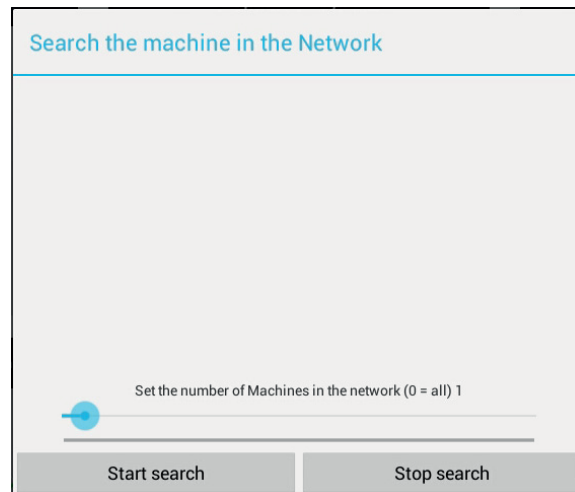

Tap on “Silca-Futura...” in the following window to obtain a connection between the Futura’s **APPS Silca.apk** and the machine.

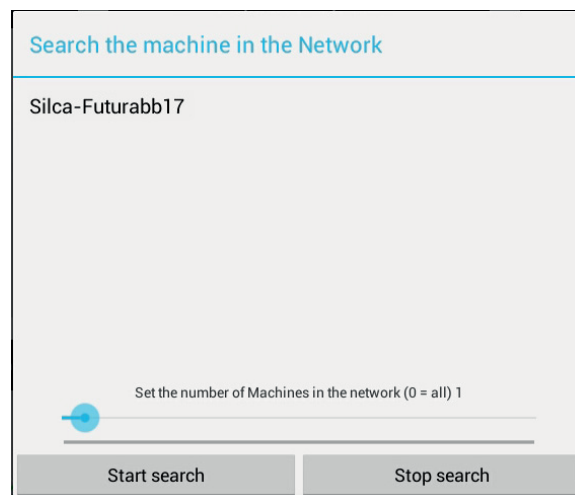

NOTE: the last mode setting will be automatically saved by the machine at each successive reboot; if the last set mode was LOCAL NETWORK and this mode is not recognized within a certain time frame the Futura Edge will automatically go to ACCESS POINT mode.

5.4 MACHINE MAINTENANCE

• Digital Inputs

This function is used to test operation of the digital inputs on the electronic board to which they are connected: screen micro, gauge position sensor, electrical contact, etc.

To perform the test carry out the movement described for each item and check that the relative signal changes color from red to green.

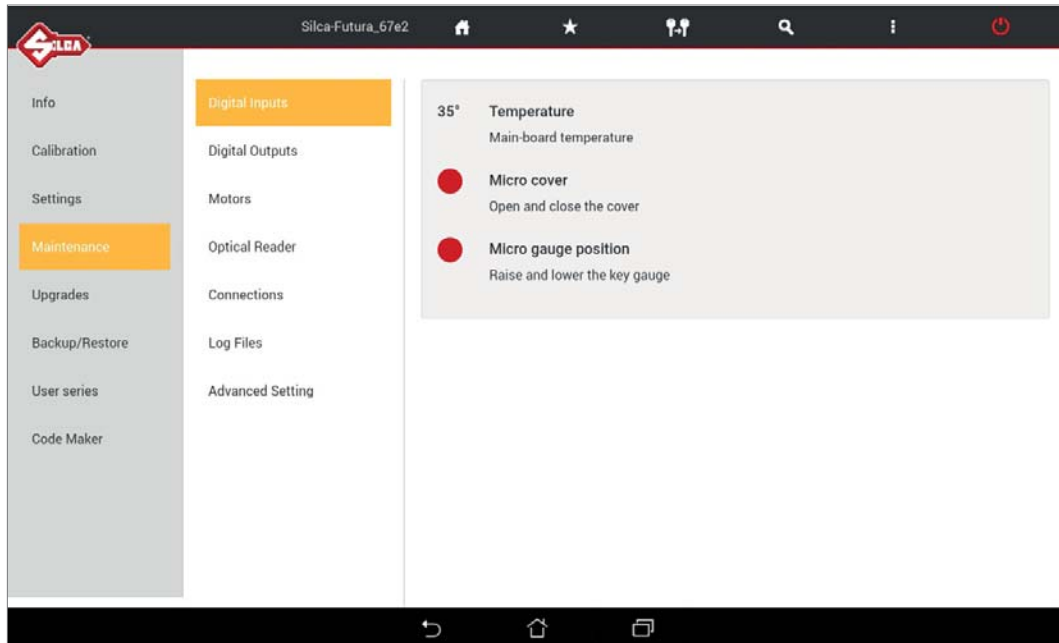

• Digital Outputs

This function is used to test operation of the digital outputs on the electronic board and relative devices connected to it. To perform the test tap ON on the screen.

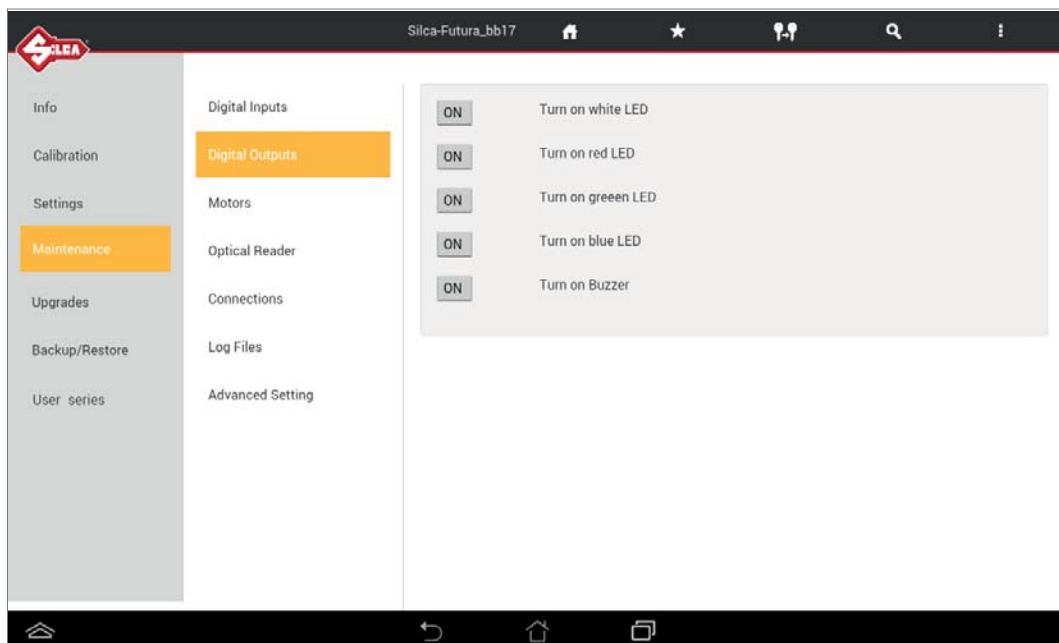

• **Motors**

This function is used to test operation of the 3 step motors for the X, Y and Z axes (at the moment the B axis is not used). To perform the test tap “+” for the axis involved.

Note: The carriage must not reach and hit the end of its run.

The Reset key homes the axes.

NOTE: tap “-” only when the value shown in the “Working position” field is positive.

Axis clearance sensor: the ring becomes green when activated.

• **Cutter motors**

To perform the test tap the button for the motor to be tested: check that the cutter turns for 5 seconds.

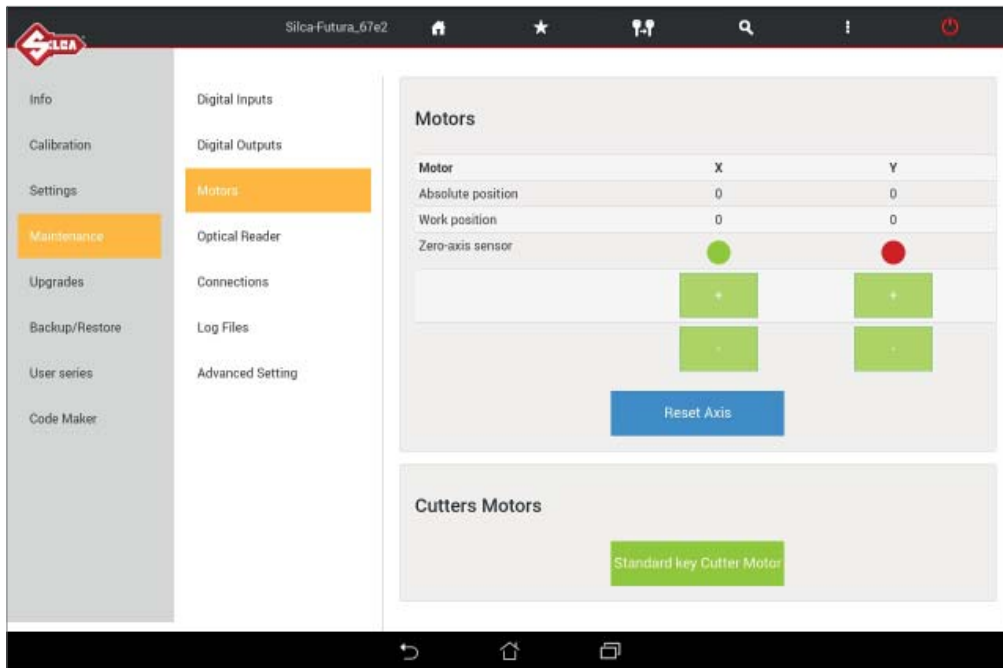

• **Optical Reader**

Perform the Optical reader threshold test to verify if the optical reader is active.

- Tapping on the “Read laser threshold” switches the optical reader from “-” to “0”.

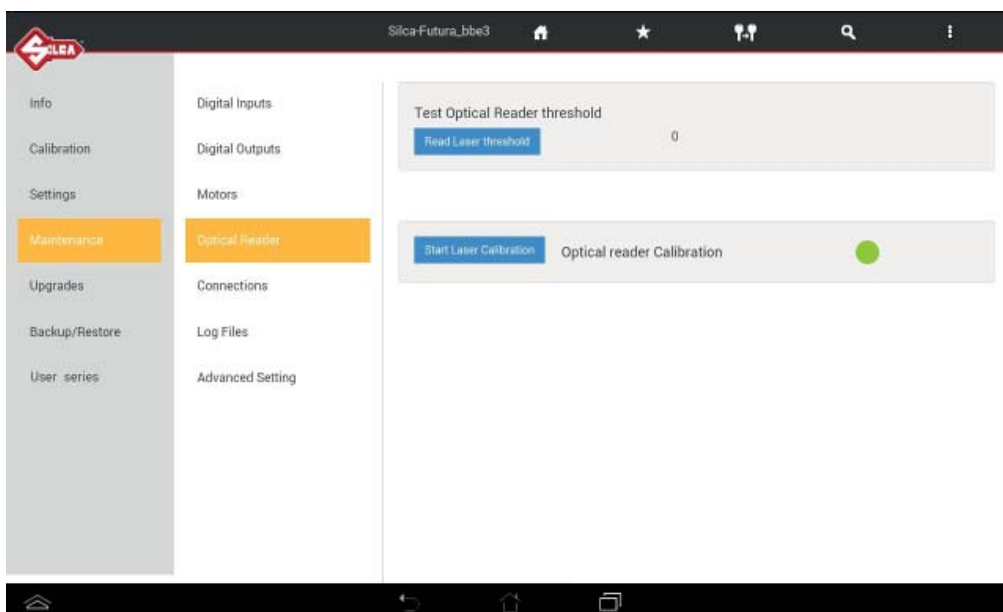

- Perform the Optical reader threshold test only if encountering anomalies when reading and/or decoding keys.
- Thoroughly clean the optical reader's glass, close the protective shield.
- Tap on "Optical reader calibration":
 - the green ball indicates that the optical reader is calibrated.
 - the red ball indicates that you must thoroughly clean the optical readers lens and re-calibrate the reader.

ATTENTION: after the Optical reader calibration proceed with the machine zero points calibration (standard flat keys) then with the standard flat keys clamp calibration.

• Connections

This function shows all the machine connections that are available.

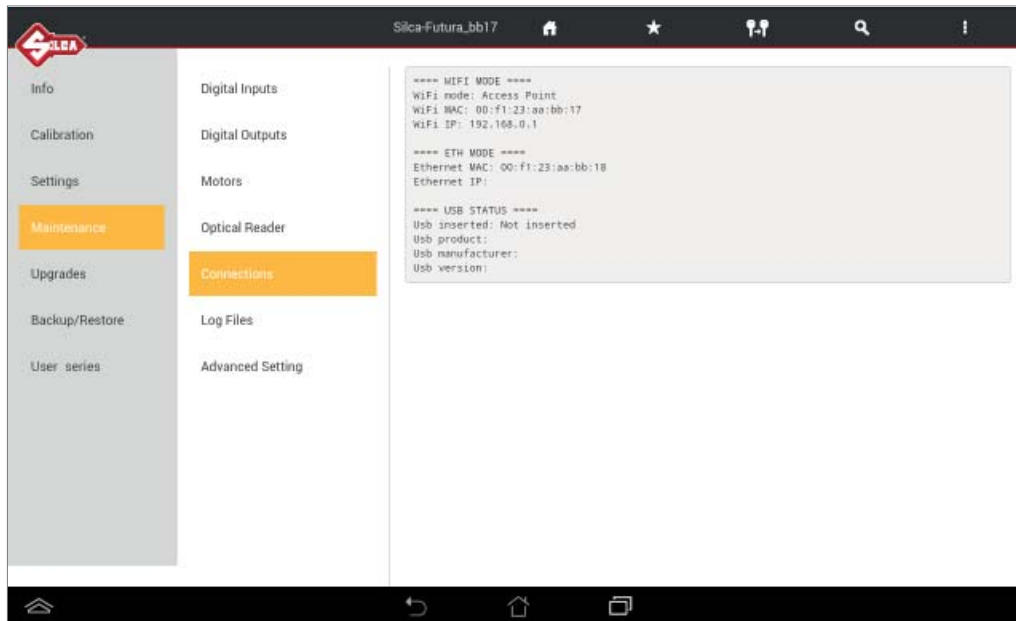

• Log Files

The Log file is requested by Silca when on board machine software anomalies are encountered. This function permits to create and save a log file:

- on a USB key connected to the machine's USB port (Fig. 7).
- or directly to Silca's Server (with the machine connected to a local network) Wi-fi or LAN cable connection).

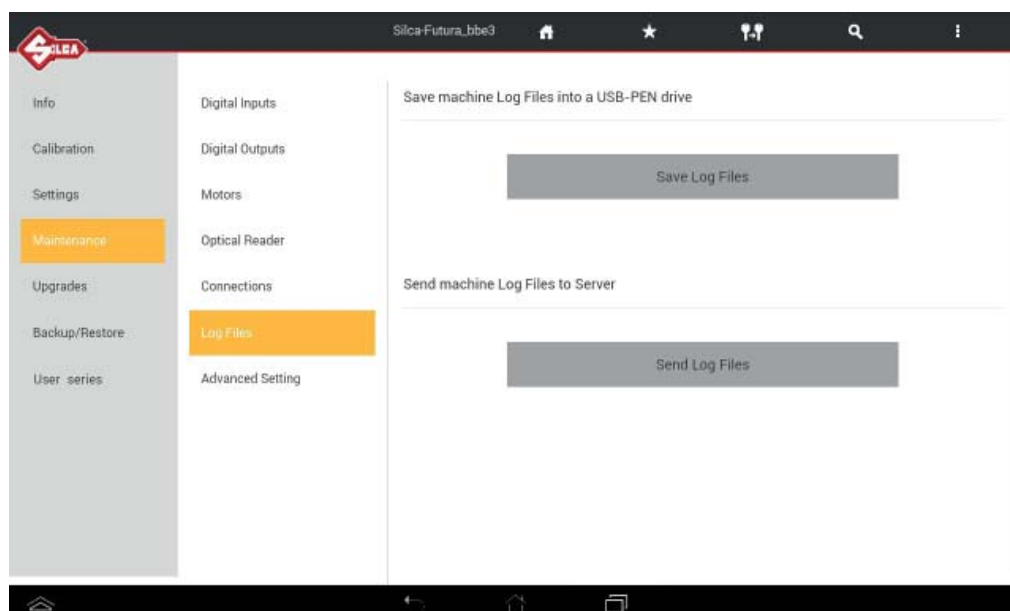

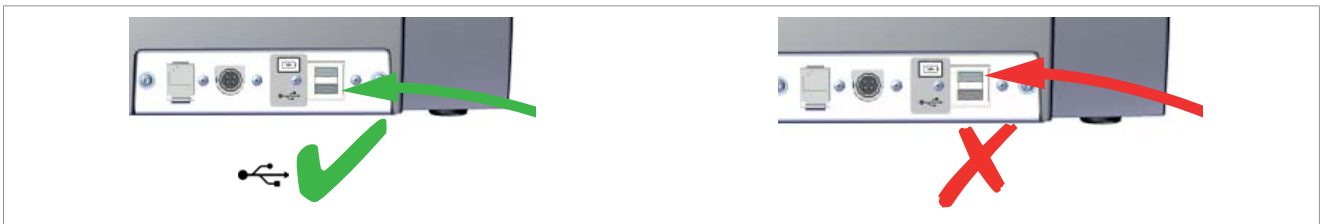
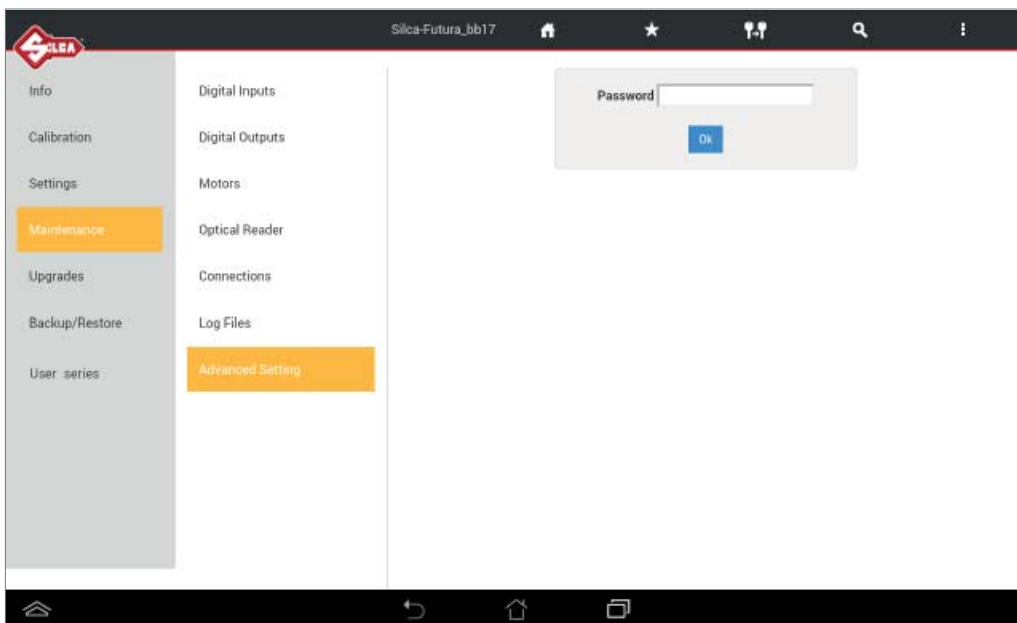

Fig. 7

- **Advanced Setting**

Function for Silca internal use.



6 MACHINE UPDATE AND REGISTRATION

6.1 MACHINE REGISTRATION

To download the machine software updates you must be registered on the SILCA WEB FUTURA server. **This operation is required only on first access.**

After cutting at least 50 keys you are required to register the machine (only if not yet done) on the Silca FUTURA web server.

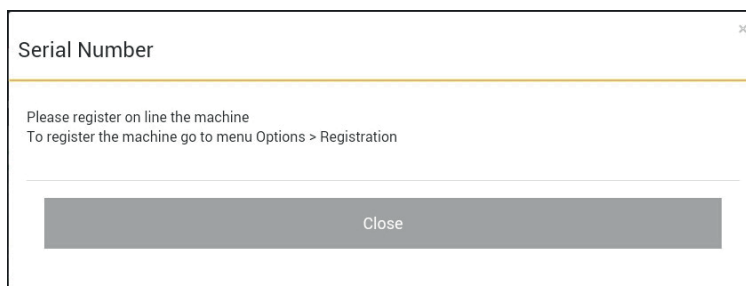

- If the machine is not registered now, the same message will appear every time Futura Edge is started.
- If the machine is not registered it will not be possible to download software updates.

There are 4 ways to register:

Method 1: Futura Edge machine with access to the internet

Method 2: Futura Edge tablet with access to the internet

Method 3: Using the Silca Remote Service (SRS) program

Method 4: Using a browser on a PC/tablet connected to the internet

Method 1

Futura Edge machine with access to the Internet

- Start the FUTURA program; tap the icon OPTIONS -> Settings -> Registration
- Enter the data into the fields shown (those with * are required) and then tap Register and wait for a message communicating that the machine has been registered. Tap Close.

NOTE: Tap  to view the registration method for FUTURA EDGE machines.

A message confirming registration will arrive at the address given.

Use your mail program to open the e-mail from Silca and click on “Validating email”.

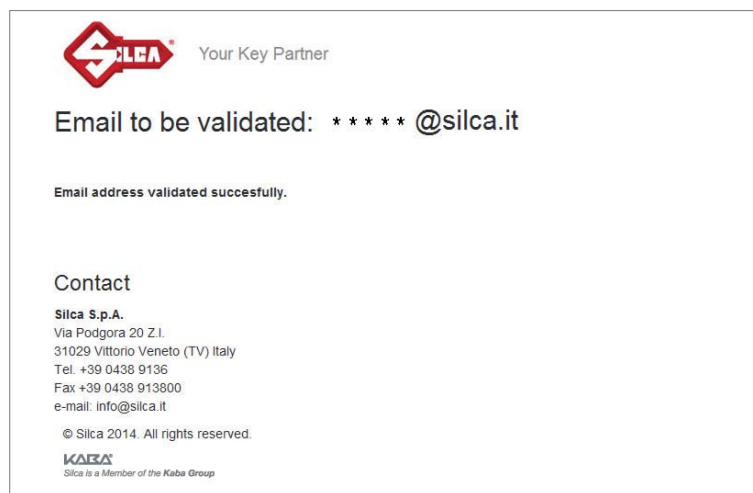
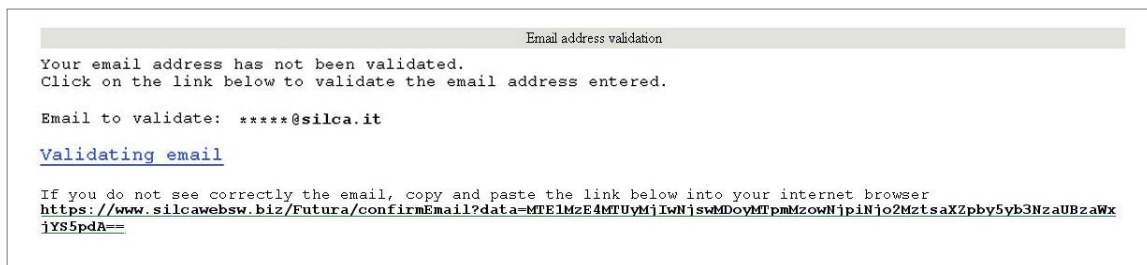

At the end, tap “Close” and then “Check” to conclude the registration procedure on the Tablet.

Method 2

Futura Edge tablet with access to the internet

NOTE: the Tablet must be taken where there is a Wi-Fi connection with internet access.

Connect a tablet to your local Wi-Fi network and connect to the internet to start the Silca FUTURA APP. Scroll from left to right to open the drop-down menu, as shown below.



Tap “Machine Registration”.

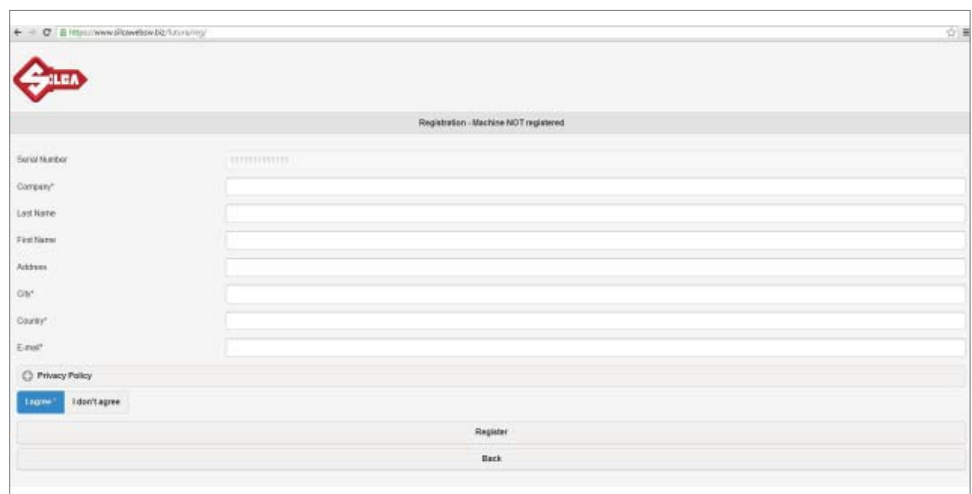
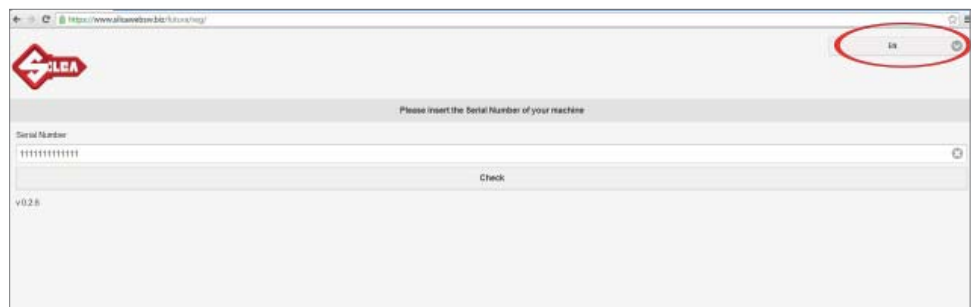

- If the serial number is not read, digit its thirteen numerical characters and press “Check”.
- Enter the data into the fields shown (those with * are required) then tap Register.

- A message confirming registration will arrive at the address given. Use your mail program to open the e-mail from Silca and click on “Validating email”.

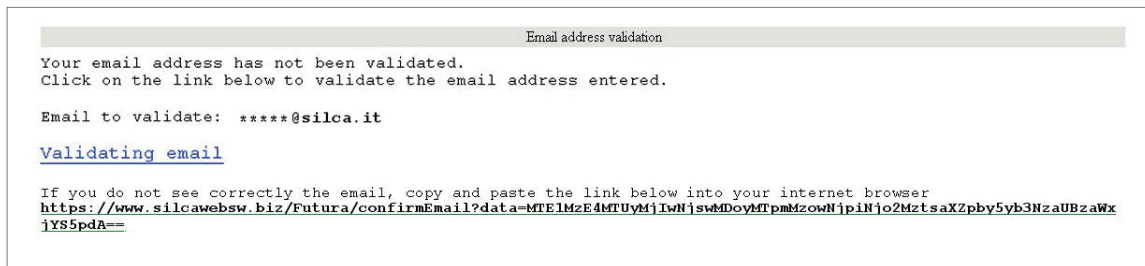

- Go back to the Futura Edge machine and re-connect in ACCESS POINT mode.

NOTE: when the machine is updated for the first time registration data will be transmitted by the Futura WEB server to the machine.

Method 3

Using the Silca Remote Service (SRS) program

Futura Edge machine and Tablet connected in ACCESS POINT mode

Install the “**Silca Remote Service**” program on your PC. The program can be downloaded from the Silca website www.silca.biz, by selecting the Products menu -> Silca Key Programs -> SKP Modules -> Silca Remote Service.

Products Silca Key Programs SKP Modules **Silca Remote Service**

Silca Remote Service



Utility for updating programs on board devices in the RW (copying transponder keys) and Optika families, Futura and Easy Scan over the Internet.

[Silca Remote Service Module \(PDF\)](#)

↓ Download

- Start the program and select the Futura Edge machine model, select the “Next” button and then “Register”: a dedicated web page will appear.
- If the machine has not already been registered, enter the data in the relevant fields (fields marked * are required) and then tap “Register”.
- A message will be sent to the given email address to confirm registration. Use your mail program to open the email from Silca and click on “**Validating email**”.

Email address validation

Your email address has not been validated.
Click on the link below to validate the email address entered.

Email to validate: *****@silca.it

[Validating email](#)

If you do not see correctly the email, copy and paste the link below into your internet browser
<https://www.silcawebsw.biz/Futura/confirmEmail?data=MTE1MzE4MTUyMjIwNjswMDoyMTpmMzowNjpiNjo2MztsaXZpbj5yb3NzaUBzaWxjYS5pdA==>



Your Key Partner

Email to be validated: *****@silca.it

Email address validated successfully.

Contact

Silca S.p.A.
 Via Podgora 20 Z.I.
 31029 Vittorio Veneto (TV) Italy
 Tel. +39 0438 9136
 Fax +39 0438 913600
 e-mail: info@silca.it

© Silca 2014. All rights reserved.

 Silca is a Member of the Kase Group

The machine is now registered.

6.2 MACHINE SOFTWARE UPDATE

Silca periodically releases Software and Data Updates for the machine. To check for new updates use one of the connection methods available.

ATTENTION: Do not insert a USB modem sticks for the transfer of data in the machine USB port.

NOTE: before starting, check that the machine is registered (shown on the Machine Registration screen - on the Tablet scroll from left to right to open the drop-down menu).

Futura Edge can be updated in one of the following ways:

- 1) Update by TABLET
- 2) Update by USB PEN DRIVE
- 3) Update through LOCAL NETWORK
- 4) Update by SRS (Silca Remote Service) program

6.2.1 Update by TABLET



Fig. 8

ATTENTION: Make sure there is no USB PEN in the Futura Edge machine USB port during updating.

- 1) Take the tablet to a place with a Wi-Fi network and internet connection and connect.
- 2) Start the Silca Futura APP and follow the instructions on the screen:
 - On the Tablet scroll from left to right to open the drop-down menu.
 - Tap “Machine registration” (Fig. 9).
 - Enter the machine serial number (13 digits) and then tap “Check”.

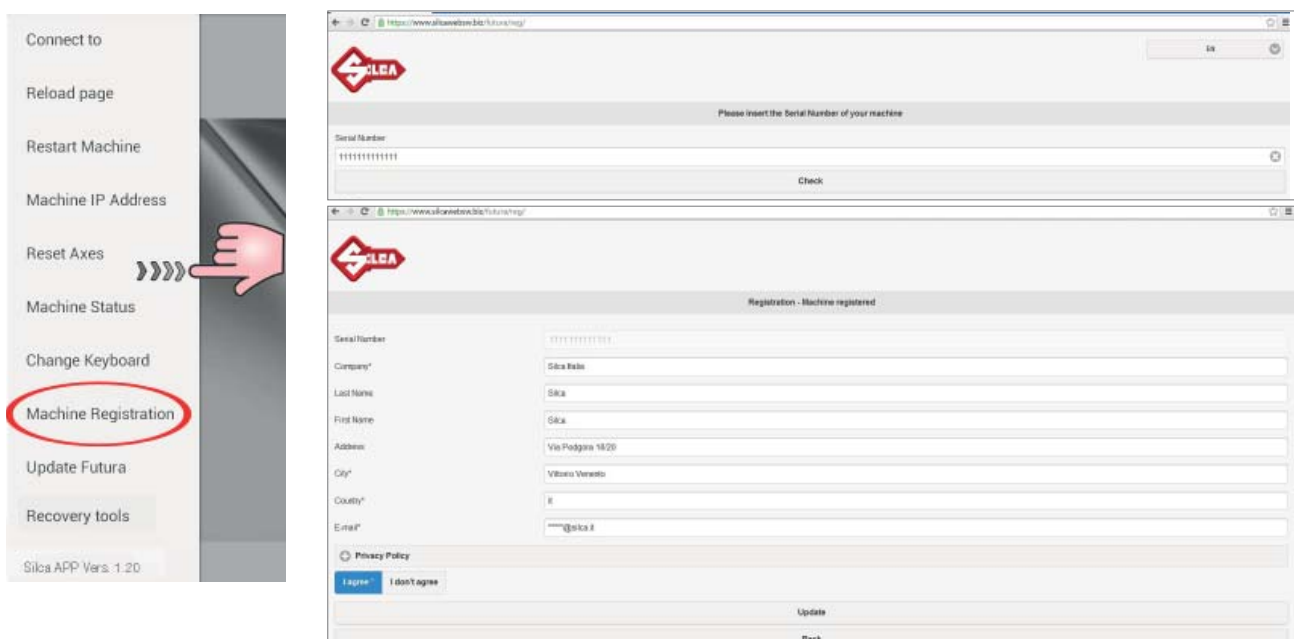

Fig. 9

- On the Tablet scroll from left to right to open the drop-down menu
- Tap “Machine update”; the following screen will appear:

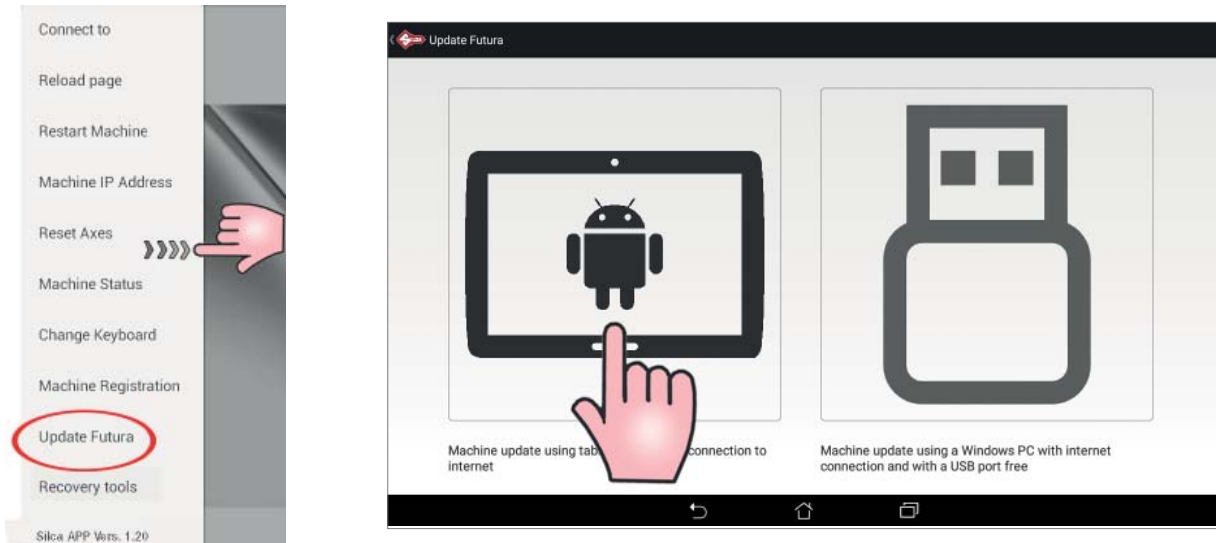

Fig. 10

- Click on the tablet image (Fig.10) and follow the guided procedure (if the tablet is not connected to a Wi-Fi network you will see a screen from which a Wi-Fi network can be selected).
- When the new update has been downloaded you will be asked to re-start the machine so that the update will be applied automatically.
- Press the “Re-start machine” button and wait a few minutes. The tablet will automatically connect to Futura Edge.

6.2.2 Update by USB PEN

This update procedure is used to update the Futura Edge machine using a PC connected to the internet and a USB PEN.

- 1) Select “Machine update” from the drop-down menu and tap the USB PEN image (Fig. 11). Insert the USB PEN DRIVE into the machine and follow the instructions on the screen.

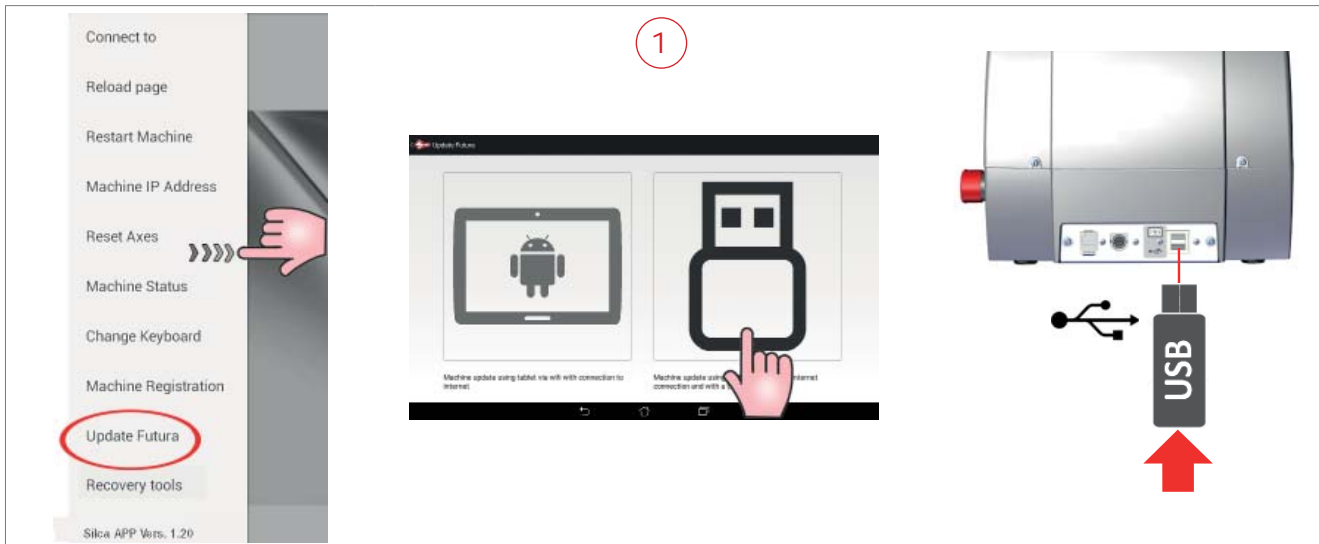

Fig. 11

- 2) Insert the USB PEN DRIVE into a PC connected to the internet (Fig. 12).
 - Open the USB PEN DRIVE, click on the file “FuturaUpgrade.exe” and wait for the “operation successful” message to appear on the screen.
 - Remove the USB PEN DRIVE from the PC (safe hardware removal).

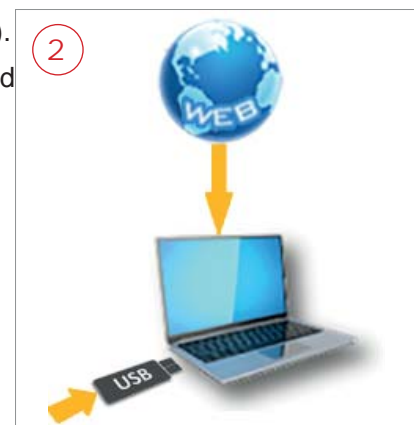

Fig. 12

- 3) Insert the USB PEN DRIVE into the special port on FUTURA EDGE (Fig. 13). Follow the instructions on the screen: tap the “RE-START FUTURA” button to re-start the FUTURA EDGE machine.
 - Wait a few minutes until the white light flashes regularly.
 - Remove the USB PEN DRIVE from the machine (without turning it off). Wait for Futura Edge to re-start (regularly flashing blue light).
 - Start the FUTURA APP from your tablet.

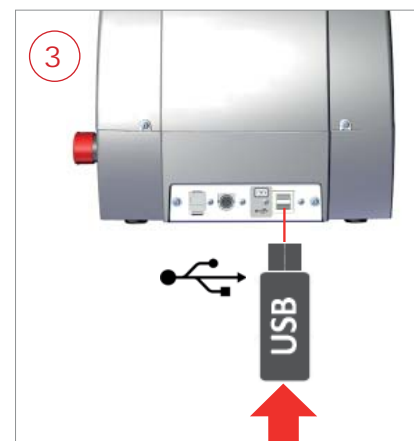

Fig. 13

6.2.3 Update with LOCAL NETWORK connected to the internet



Fig. 14

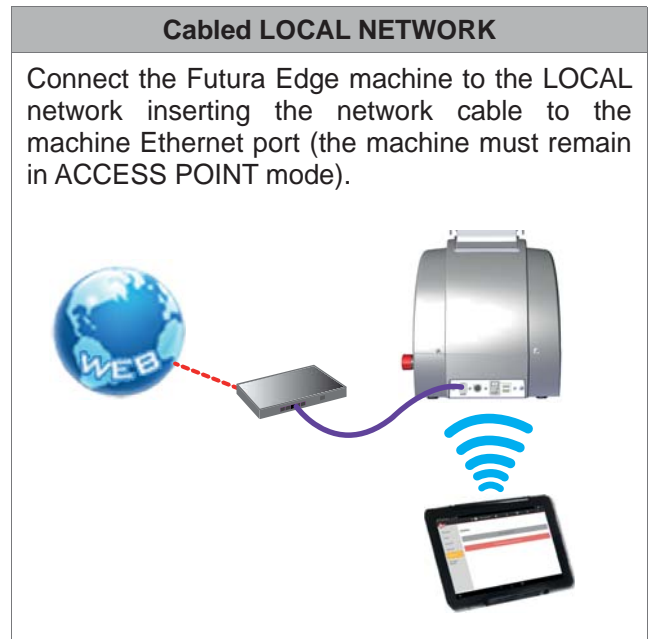

Fig. 15

ATTENTION: Make sure there is no USB PEN in the Futura Edge machine USB port during updating.

To upgrade the FUTURA EDGE machines software in manual mode, follow the steps indicated below.

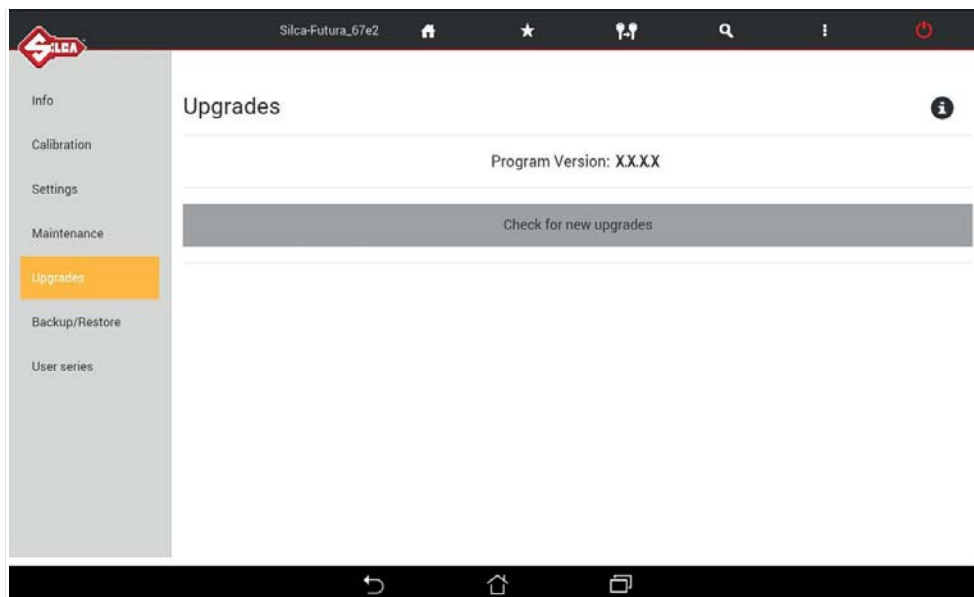



Fig. 16

NOTE: tap  to view machine update methods.

- Tap on “Check for Updates” to get a list of what will be downloaded with the update.

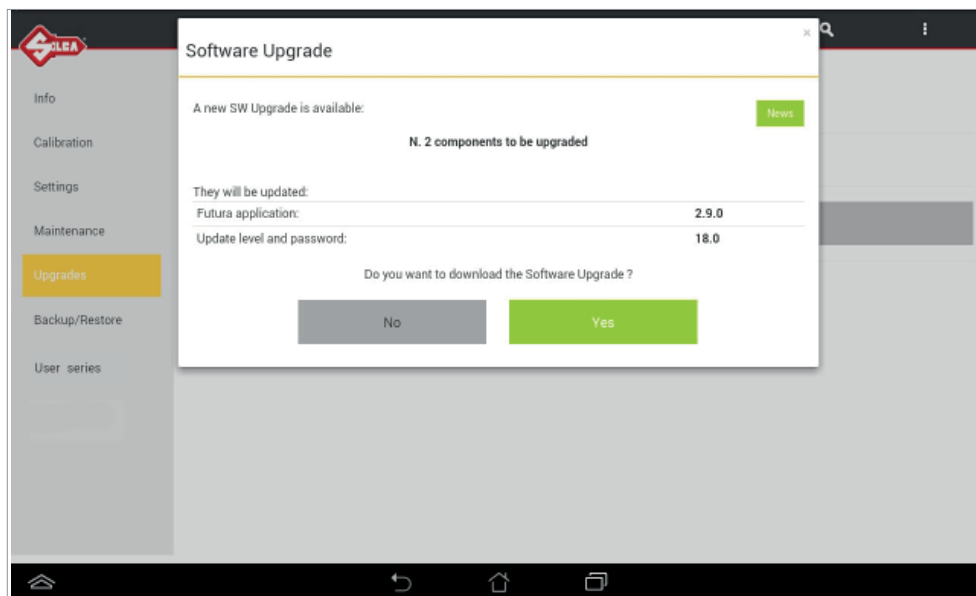

Fig. 17

- Tap “News” to see information about the update to be installed on the machine.
- Tap on “Yes” to start downloading.
- When download is over, you will be asked to restart the FUTURA EDGE machine (procedure run by the software). Follow the on-screen instructions.

6.2.4 Update with SRS Program (Silca Remote Service)



Fig. 18

Install the “Silca Remote Service” program on your PC. The program can be downloaded from the Silca website www.silca.biz, by selecting the Products menu -> Silca Key Programs -> SKP Modules -> Silca Remote Service



The machine can be updated in the following ways:

Method 1 (QUICK update)

QUICK update saves time as it downloads only the files needed.

ATTENTION: you need a blank FAT32/NTFS format USB PEN.

- Fit a blank format FAT32/NTFS USB PEN into the Futura Edge machine and open the machine software; go to the Diagnostics menu -> Log File and press “Save log file” on the USB PEN.
- Fit the USB PEN into the PC on which the SRS program is installed, go to the SRS program screen regarding **QUICK update** preparation and wait for the update file to be saved on the machine. If the machine is not registered you will be required to register using the special website page.
- Ensure that the Futura Edge machine is off (red push button) and that the FUTURA APP on the Tablet is closed.
- Fit the USB PEN into the machine USB port (on the rear of the machine - Fig. 7, page 48).
- Start the Futura Edge machine and wait a few minutes until the white light flashes regularly. Remove the USB PEN (without turning off the machine). Wait for Futura Edge to re-boot (blue light flashing regularly). Start the Futura APP from your Tablet.

ATTENTION: do not unplug or turn off Futura Edge during updating.

Method 2 (TOTAL update)

TOTAL update will download all the files on the machine

Start the program  and select the Futura Edge machine.

ATTENTION: you need a blank FAT32/NTFS format USB PEN.

- Enter the Futura Edge machine serial number into the SRS program screen regarding update preparation and then fit a USB PEN into the PC. Wait for the **TOTAL update** file to be saved on the USB PEN. If the machine is not registered you will be required to register using the special website page.
- Ensure that the machine is off (red push button) and that the FUTURA APP on your Tablet is closed.
- Fit the USB PEN into the machine USB port (on the rear - Fig. 7, page 48).
- Start the Futura Edge machine and wait a few minutes until the white light flashes regularly. Remove the USB PEN (without turning off the machine). Wait for Futura Edge to re-boot (blue light flashing regularly). Start the Futura APP from your Tablet.

ATTENTION: do not unplug or turn off Futura Edge during updating.

6.3 APP UPDATE (Silca.apk and SilcaKeyboard.apk)

After you updated the Futura Edge machine's software, when the program starts up, you may see the following screen indicating that a new version of the **Silca.apk** or **SilcaKeyboard.apk** is available.

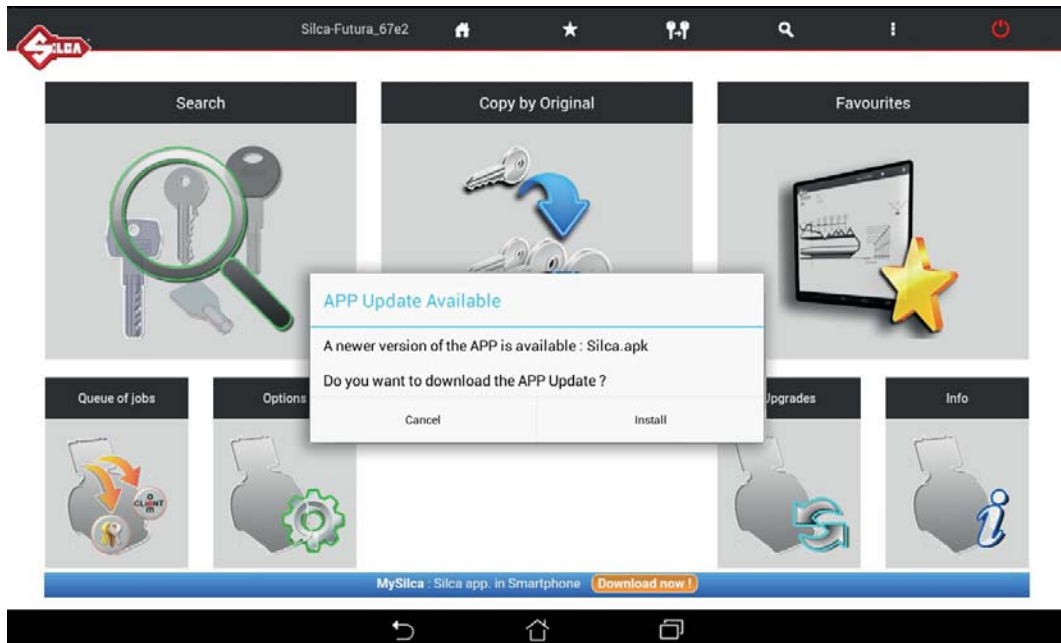

Fig. 19

Tap on “Install” and proceed with updating the APP.

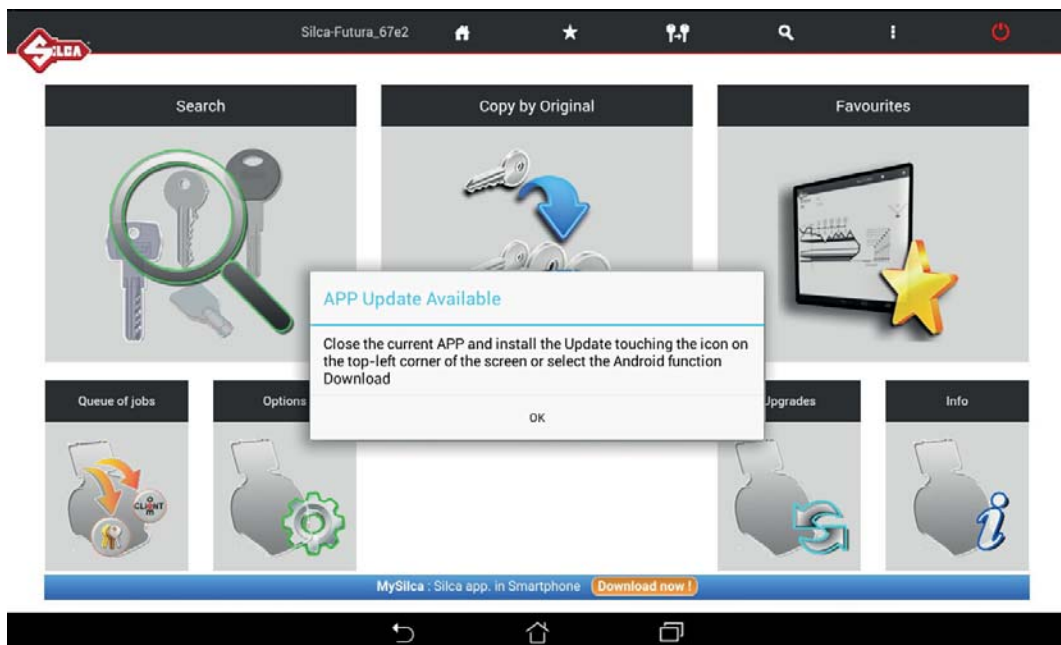

Fig. 20

Close the application that is opened by tapping on  and dragging the Futura APP downwards off the screen (see Fig. 21).

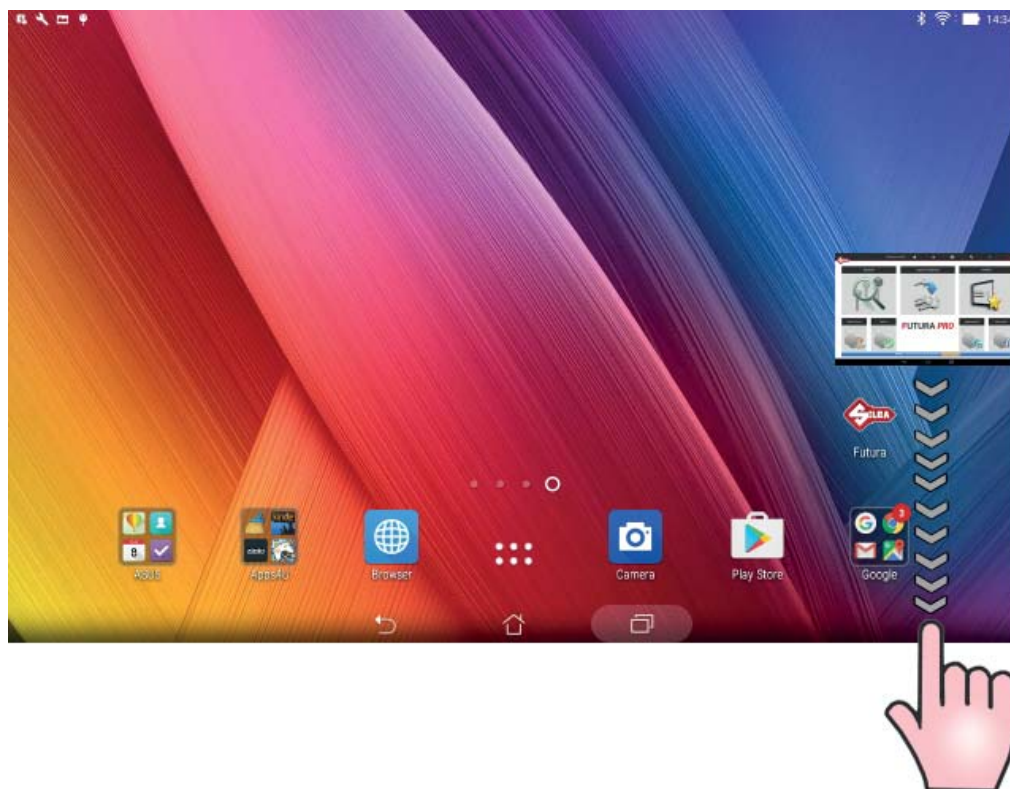

Fig. 21

Select "Downloads" from the tablet "Setting" menu  (Fig. 22).

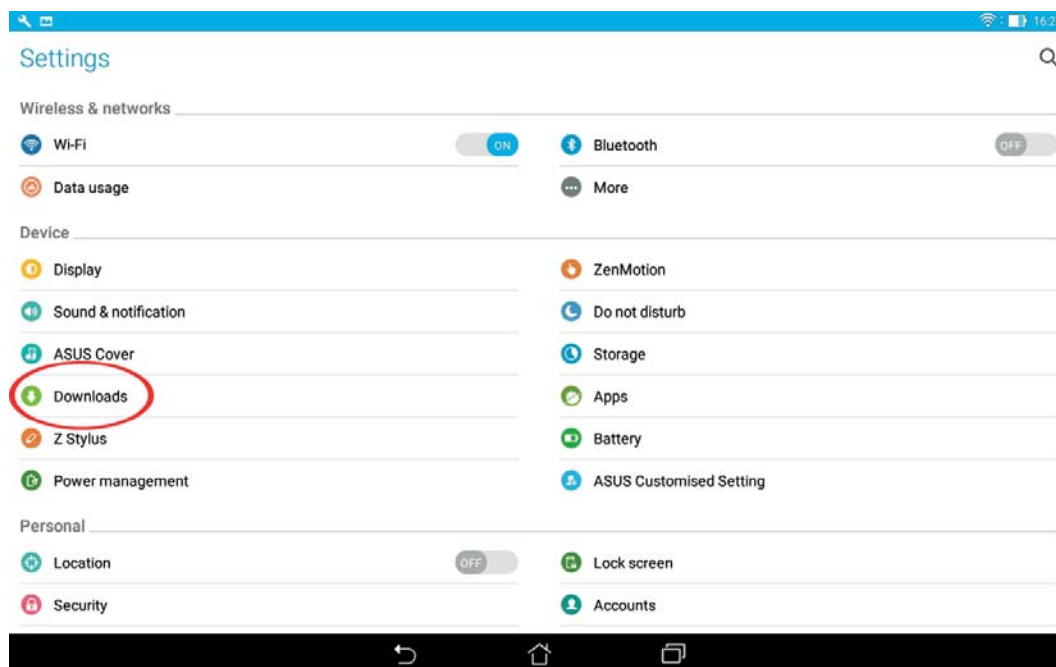

Fig. 22

Select **Silca.apk** and tap on “Install” (Fig. 23).

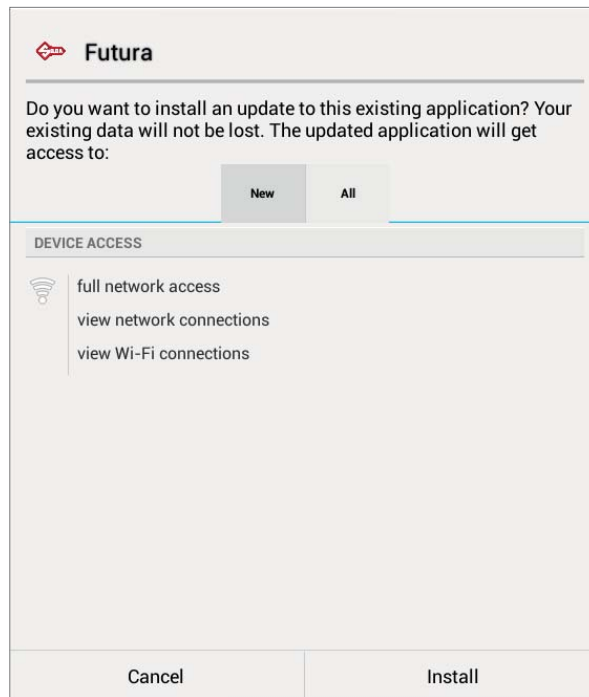

Fig. 23

Wait for the update to finish.

Do the same for upgrading the **SilcaKeyboard.apk**.

7 BACKUP / RECOVERY

This function permits to create and save a backup (backup User database) file in a USB pen that can be connected the machine's USB port (Fig. 7, page 48).

Also provided is the recovery (Restore User database) function always using the USB pen with the last file that was saved on it.

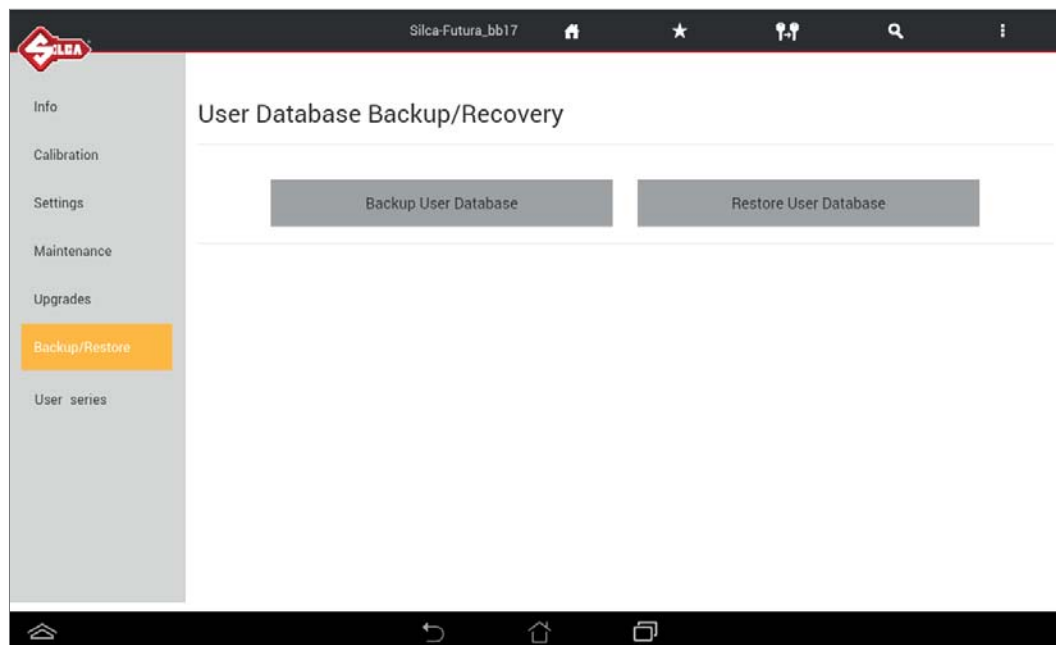

8 USER SERIES

Function accessible from “Options => User Series”.

This function is available to the user to import a code table in XML-Keso, CSV, TXT format, associating it to a data card and thereby creating a new user series.

- Use a USB-PEN, FAT32/NTFS format, and copy onto it the file (or files) with the table to be imported. **Note: the file must not be in a folder.**
- Insert the USB-PEN into the Futura Edge USB port (Fig. 7, page 48).

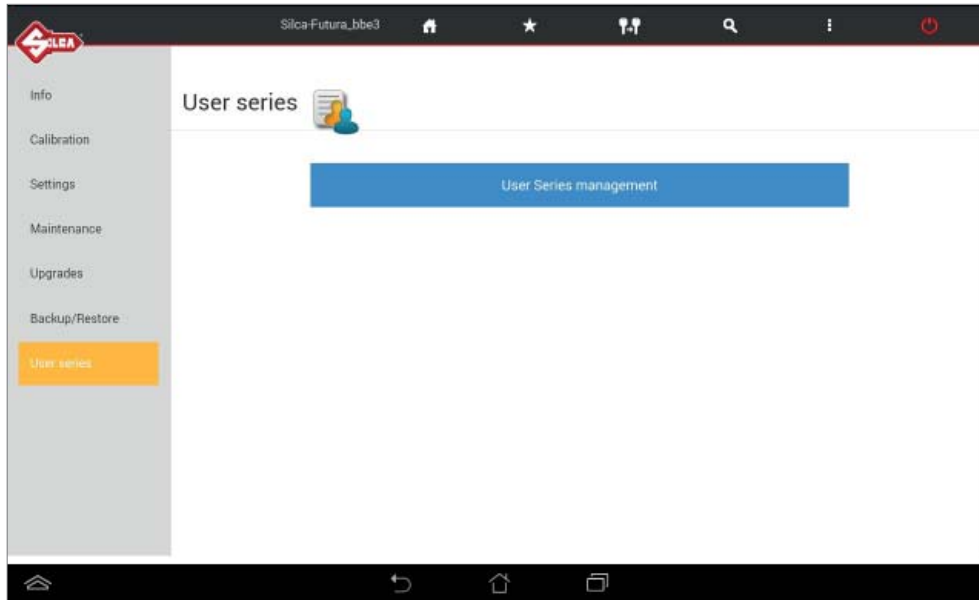

To create the user series, tap “User Series Management”.

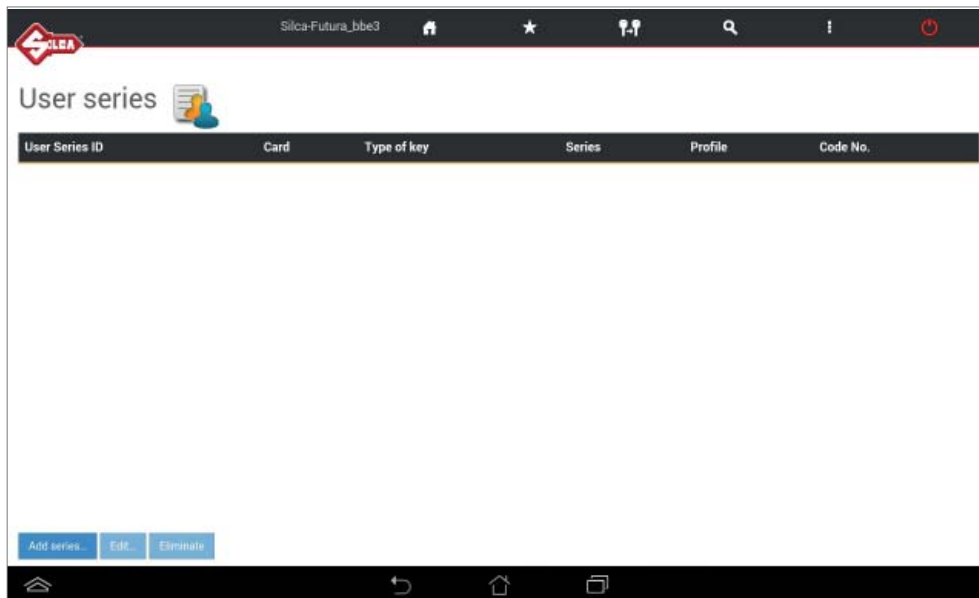

Tap “Add Series” to import the new file.

When the User Series exists and is selected/highlighted you can:

- Tap the “Edit” key to vary certain parameters associated to the series.
- Tap the “Eliminate” key to erase the selected series.

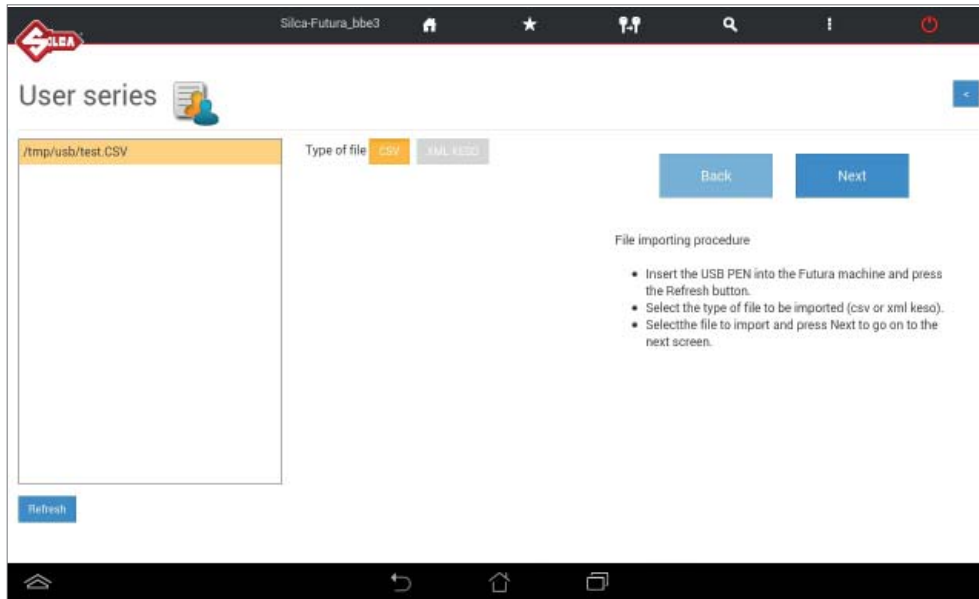

- Follow the instructions on the Tablet page. During guided import you will be required to enter or select certain parameters to associate to the new series (e.g. Data card number, Profile, Series, Makes, Applications and Key blank).
- Tap “Next” to continue.

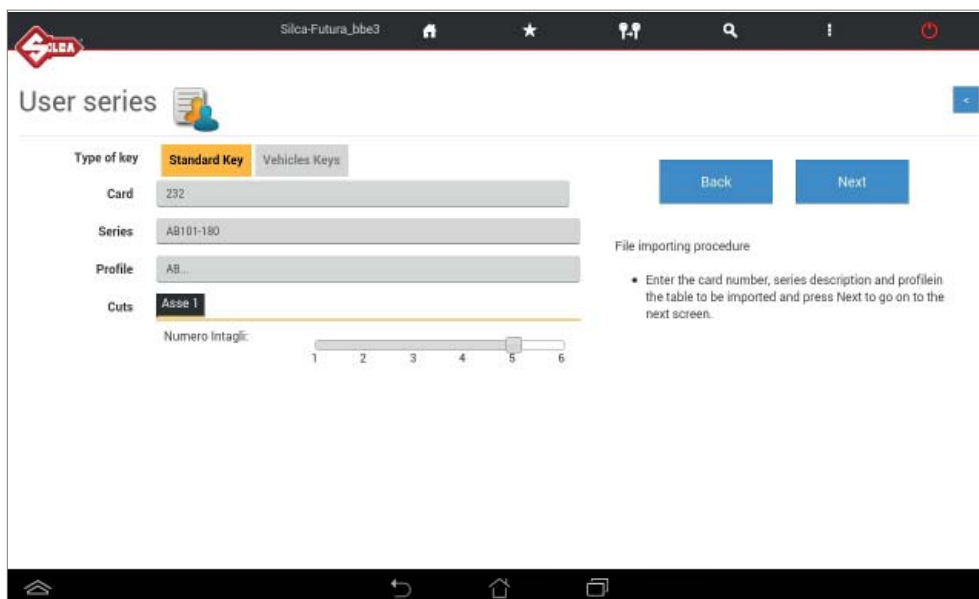

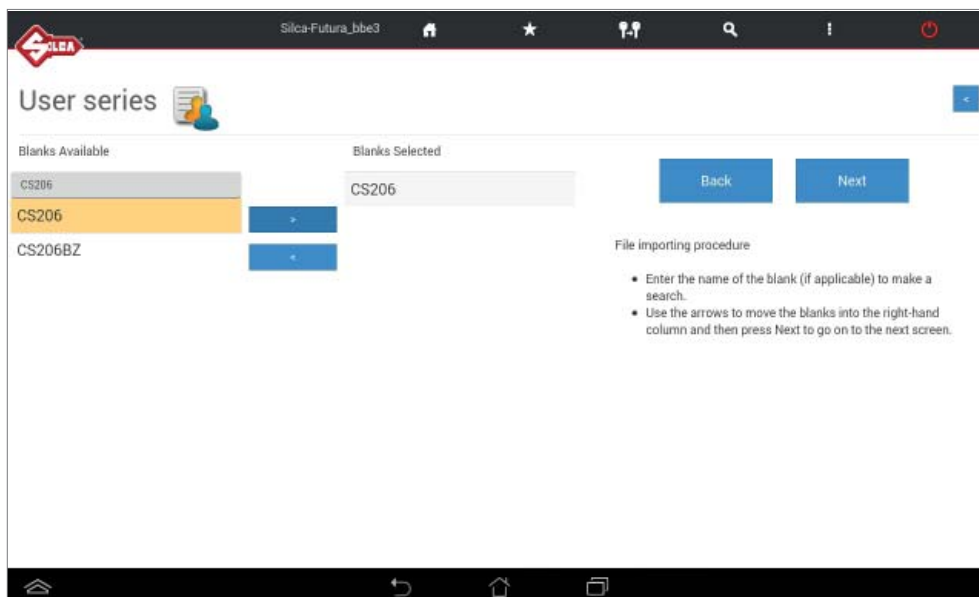
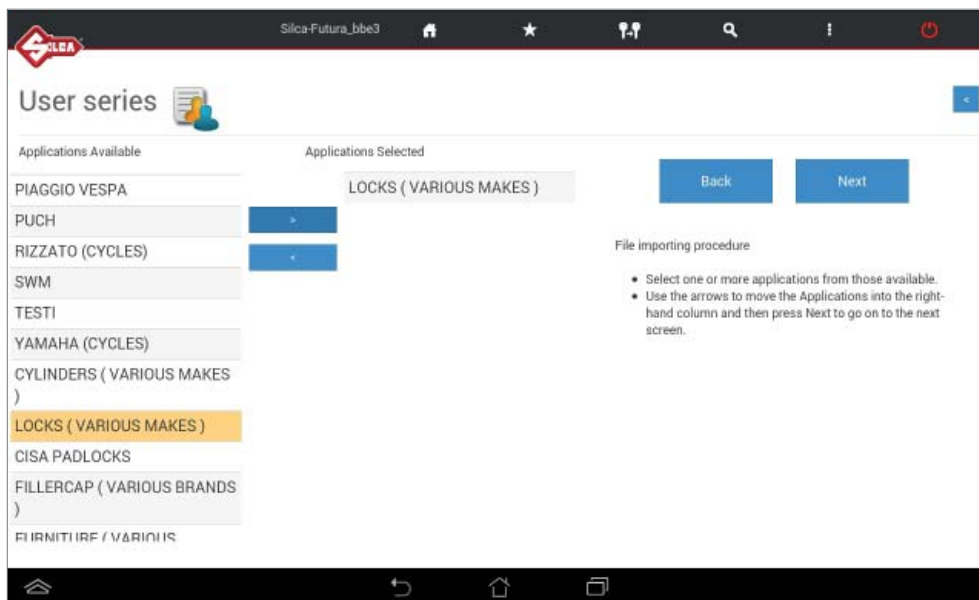
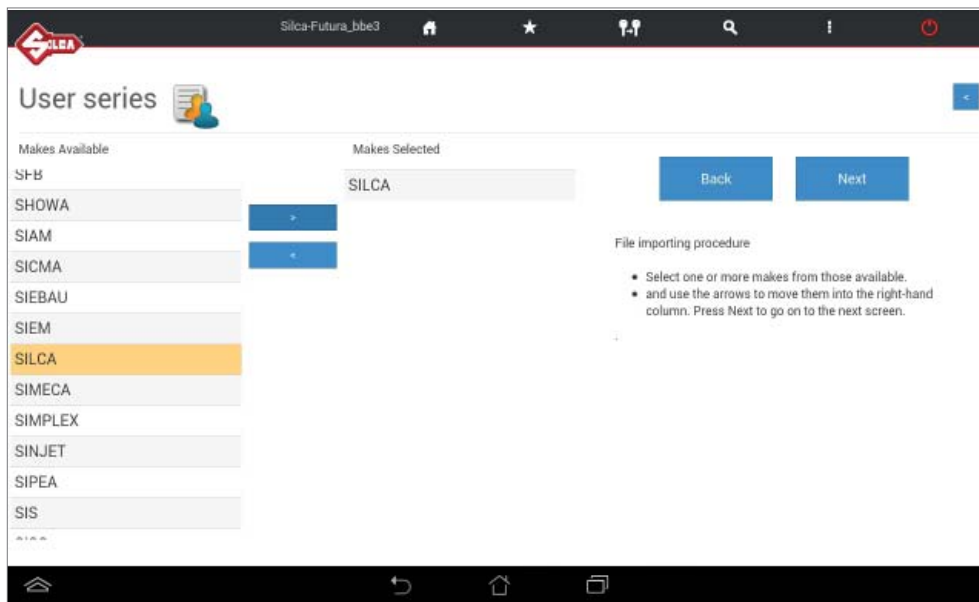

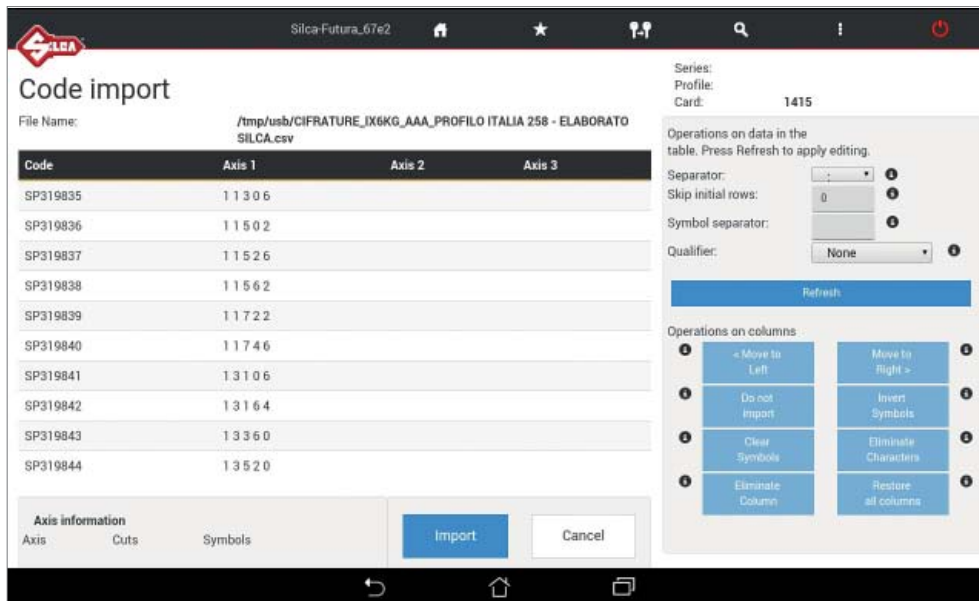

- Tap "Import" to import the file directly without editing.

NOTE: only if necessary, before terminating table import you can edit certain parameters using the menu on the right (Operation on data in the table and/or Operations on columns).

NOTE: tap  to view information about the field.

- After editing the parameters "Operation on data in the table" tap the "Refresh" key".
- After carrying out operations in the columns, tap the "Import" button to start importing the files.

At the end of the operations the following screen will appear:

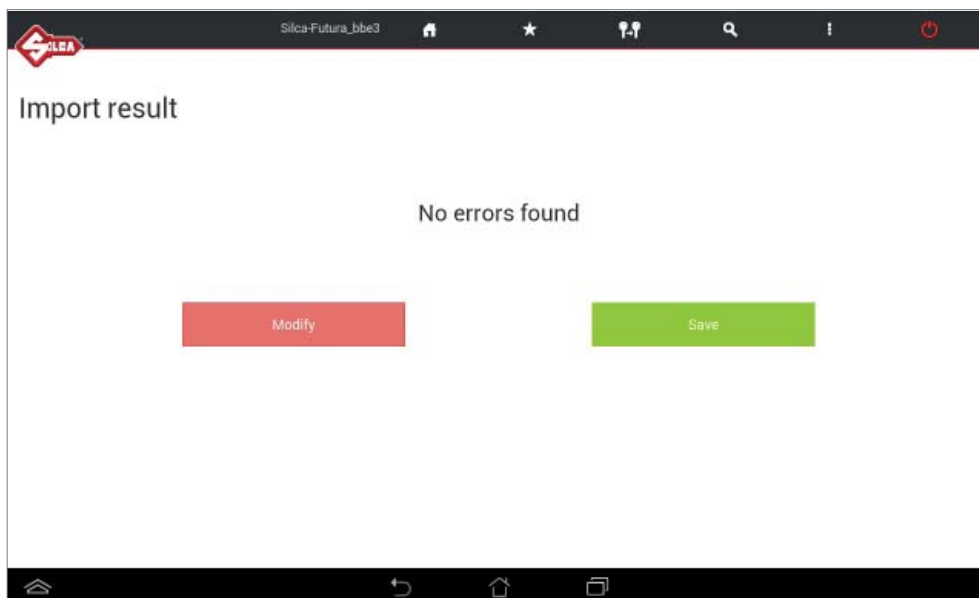

- Tap "Save" to save the new User series.
- Tap "Modify" to make changes.

9 CODE MAKER

The Code Maker function (option to buy) is used to create a new data card with user-definable cutting parameters.

An explanation of how to use the data card parameters is given in the User Data Card guided creation procedure.

When the data card has been created the program proposes the creation of a User Series which also serves as a link to a personal code table.

Note: new data cards can be created using the accessories, cutters and clamps listed below:

Data cards for FLAT/STANDARD keys

Clamp to be used: **01V** or **01VJ**

Cutter to be used: **01F**

Note: Code Maker may use other accessories in the future.

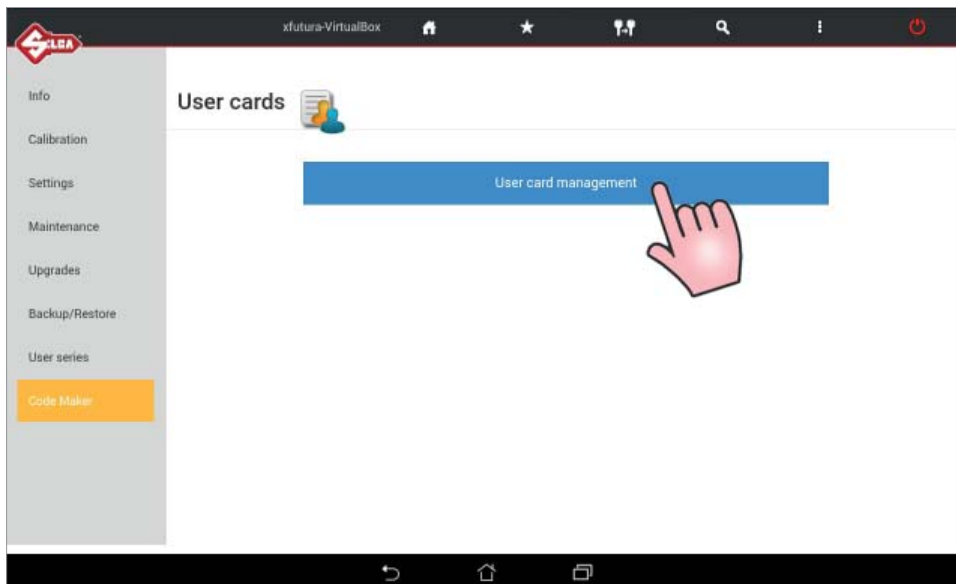

10 TRANSPONDER GUIDE



The Transponder Guide contains all the transponder key copying solutions provided by Silca. Open the Transponder Guide MENU - the search window will appear. Enter into the fields the known information about the vehicle or transponder key to view data relating to identification, copying, storage and the procedures provided by Silca:

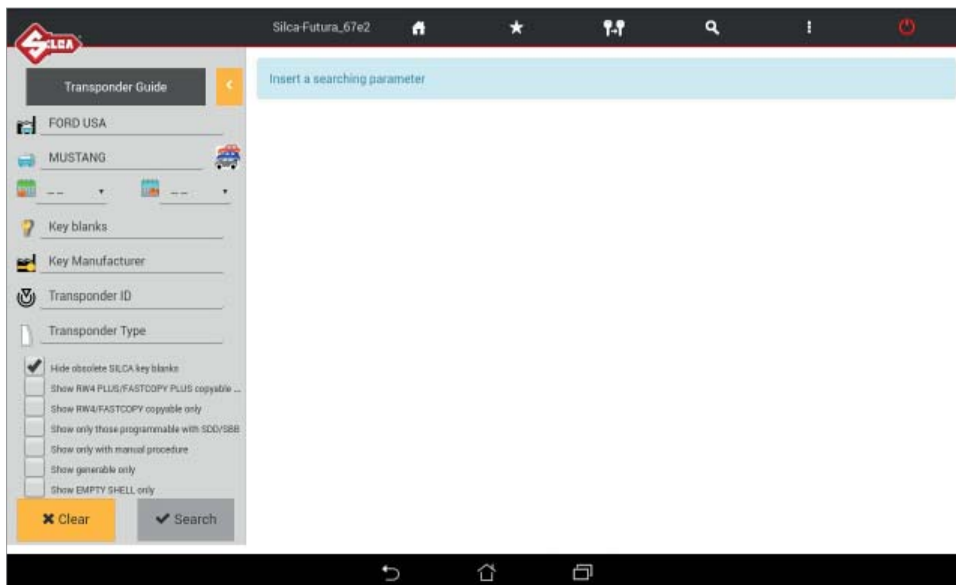

IMPORTANT:

- tap the column icon to learn the meaning of each column
- press the orange arrow  to make a new search or go back

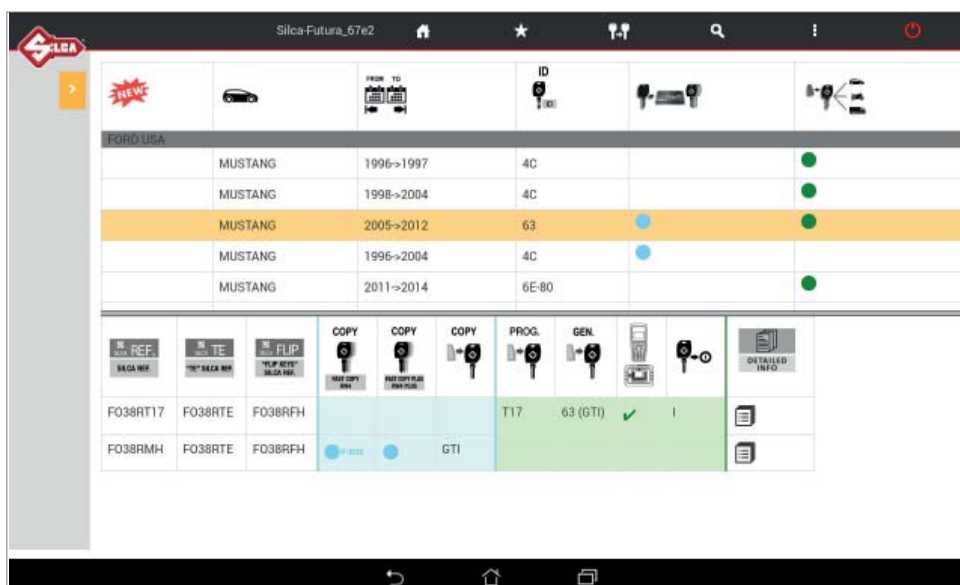

Fig. 24

Select the required car model at the top of the window.

The bottom part of the window will show detailed information about the different possibilities:

Blue section

- use one of the Silca keys indicated in the first 3 columns to create a clone of the original transponder key, i.e. a key ready for use.

Green section

- use one of the Silca keys indicated in the first 3 columns to get a key that can be programmed on the vehicle by diagnostics or manual procedure. If there is no solution with Silca keys, when programming by diagnostics or manual procedure, if available, the copy must be made from an original key.



column indicating a Silca key blank complete with transponder or ORIGINAL



column indicating a Silca key blank without transponder



column indicating a Silca FLIP key blank without transponder

Example Fig. 24

In this case the user may:

Blue section => to clone the original key with RW devices

- use FO38RMH
- use FO38RTE or FO38RFH with GTI transponder

Green section => to programme a key on the vehicle with original diagnostics (sd = see dealer)

- use FO38RT17
- use FO38RTE or FO38RFH with GTI transponder programmed as ID63 or with T17 transponder

Get further details or access “manual programming” procedures by hitting  (see Fig. 24).

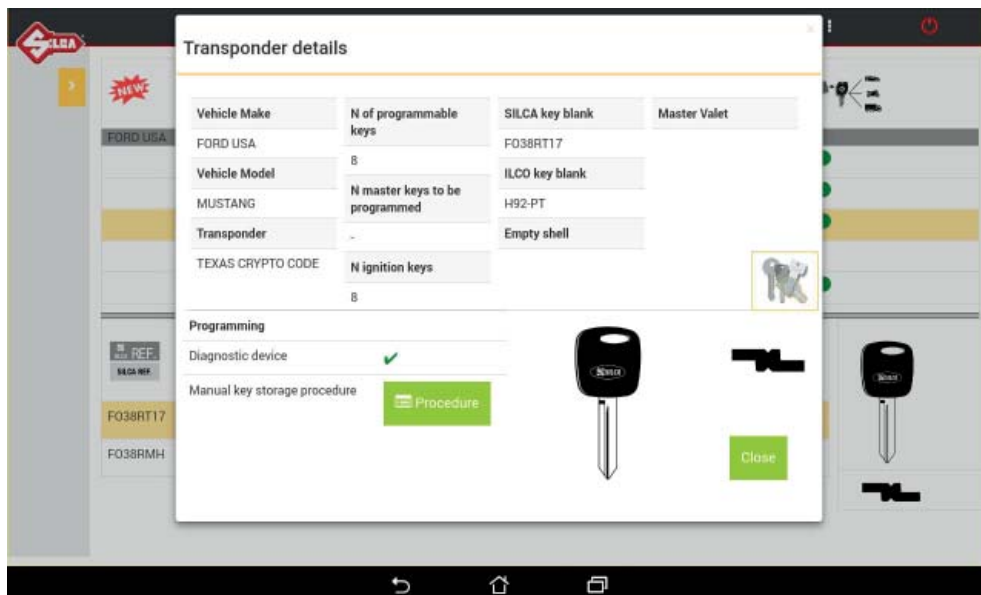



Tap icon  to make a search in the key-cutting section to find the data cards for the Silca key blank selected.

11 CHANGING TABLETS

If a new Tablet is to replace the previous one, download/install the Futura APP. and the customized “Silca Keyboard”.

Proceed as follows:

- 1) Connect the tablet <=> FUTURA in ACCESS POINT mode (Ch.5.3.3.a).
- 2) Open the browser CHROME  (the CHROME icon is in the APPS page ) and enter the following addresses:
192.168.0.1/Silca.apk to download the APP
192.168.0.1/SilcaKeyboard.apk to download the keyboard



- 3) Tap the center bottom “Open all Apps screen” icon 



4) Select “Downloads” from the tablet “Settings” menu .

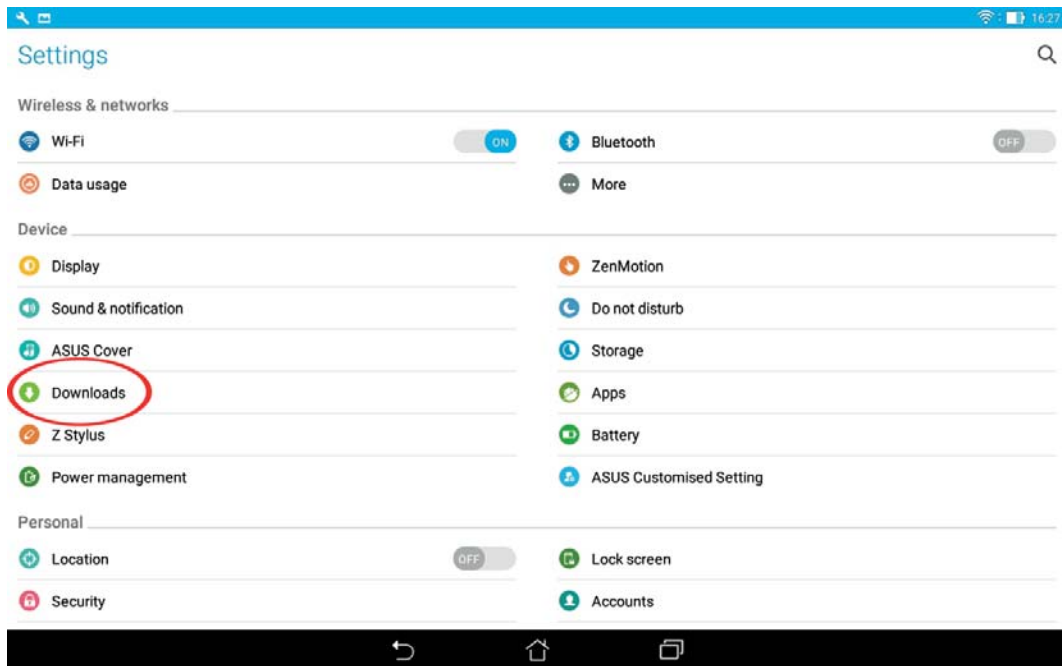

5) Tap on the 2 apps just downloaded for installation.

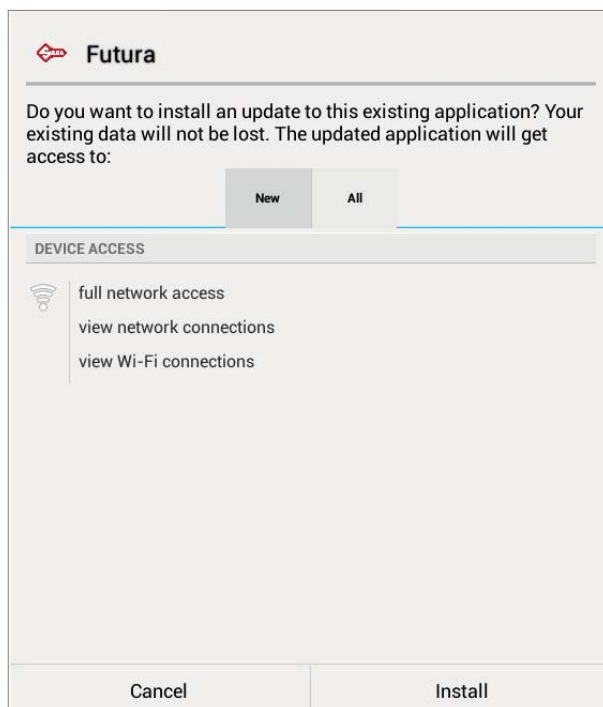

After you install the new FUTURA APP you should move the Silca FUTURA application icon  to the main screen:

- 1) Tap the center bottom “Open all APPS screen” icon 



- 2) Search for “Futura” icon 

- 3) Tap and hold (keep pressing) the Silca Futura application icon and drag it to the main screen.

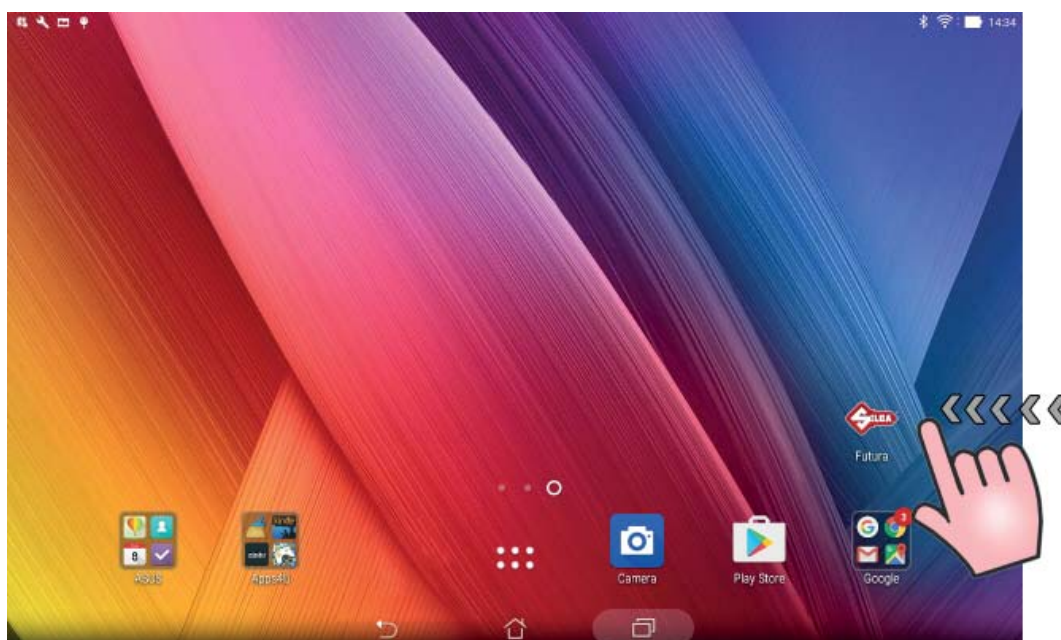

12 FUTURA PROCEDURE TO CLEAR CACHE

Clearing the FUTURA APP Cache is recommended to improve the performance of the FUTURA APP.

1) Entering the Android Tablet Settings .

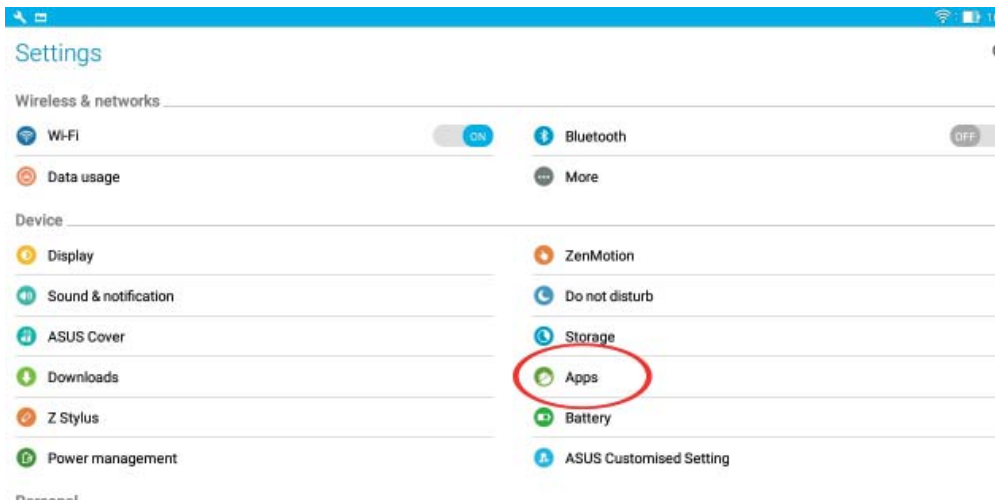

2) Tap on "APPS" and then "FUTURA".



3) Tap on "Clear Cache".

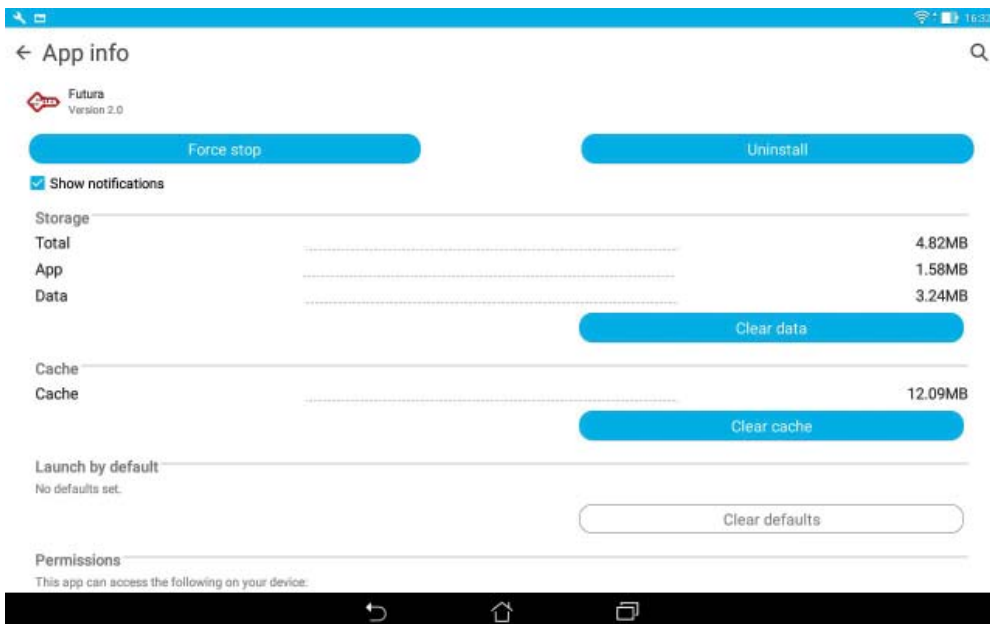

GNU GENERAL PUBLIC LICENSE

This product includes partly software owned by Silca and partly open source software. Below is the original text of the official license for open source software.

On request Silca will provide a DVD with the GPL code included in the FUTURA product.

To make the request contact SILCA at the following address:

SILCA S.p.A.

Via Podgora 20
31020 Vittorio veneto
Italy

Email: service@silca.it

The GPL code used on this product is distributed WITHOUT A WARRANTY and is subject to copyright for one or more writers.

This product also includes software developed by OpenSSL Project for use by the OpenSSL Toolkit.

GNU GENERAL PUBLIC LICENSE

Version 2, June 1991

Copyright (C) 1989, 1991 Free Software Foundation, Inc., 51 Franklin Street, Fifth Floor, Boston, MA 02110-1301 USA

Everyone is permitted to copy and distribute verbatim copies of this license document, but changing it is not allowed.

Preamble

The licenses for most software are designed to take away your freedom to share and change it. By contrast, the GNU General Public License is intended to guarantee your freedom to share and change free software--to make sure the software is free for all its users. This General Public License applies to most of the Free Software Foundation's software and to any other program whose authors commit to using it. (Some other Free Software Foundation software is covered by the GNU Lesser General Public License instead.) You can apply it to your programs, too.

When we speak of free software, we are referring to freedom, not price. Our General Public Licenses are designed to make sure that you have the freedom to distribute copies of free software (and charge for this service if you wish), that you receive source code or can get it if you want it, that you can change the software or use pieces of it in new free programs; and that you know you can do these things.

To protect your rights, we need to make restrictions that forbid anyone to deny you these rights or to ask you to surrender the rights. These restrictions translate to certain responsibilities for you if you distribute copies of the software, or if you modify it.

For example, if you distribute copies of such a program, whether gratis or for a fee, you must give the recipients all the rights that you have. You must make sure that they, too, receive or can get the source code. And you must show them these terms so they know their rights.

We protect your rights with two steps: (1) copyright the software, and (2) offer you this license which gives you legal permission to copy, distribute and/or modify the software.

Also, for each author's protection and ours, we want to make certain that everyone understands that there is no warranty for this free software. If the software is modified by someone else and passed on, we want its recipients to know that what they have is not the original, so that any problems introduced by others will not reflect on the original authors' reputations.

Finally, any free program is threatened constantly by software patents. We wish to avoid the danger that redistributors of a free program will individually obtain patent licenses, in effect making the program proprietary. To prevent this, we have made it clear that any patent must be licensed for everyone's free use or not licensed at all.

The precise terms and conditions for copying, distribution and modification follow.

GNU GENERAL PUBLIC LICENSE

TERMS AND CONDITIONS FOR COPYING, DISTRIBUTION AND MODIFICATION

0. This License applies to any program or other work which contains a notice placed by the copyright holder saying it may be distributed under the terms of this General Public License. The "Program", below, refers to any such program or work, and a "work based on the Program" means either the Program or any derivative work under copyright law: that is to say, a work containing the Program or a portion of it, either verbatim or with modifications and/or translated into another language. (Hereinafter, translation is included without limitation in the term "modification".) Each licensee is addressed as "you".

Activities other than copying, distribution and modification are not covered by this License; they are outside its scope. The act of running the Program is not restricted, and the output from the Program is covered only if its contents constitute a work based on the Program (independent of having been made by running the Program).

Whether that is true depends on what the Program does.

1. You may copy and distribute verbatim copies of the Program's source code as you receive it, in any medium, provided that you conspicuously and appropriately publish on each copy an appropriate copyright notice and disclaimer of warranty; keep intact all the notices that refer to this License and to the absence of any warranty; and give any other recipients of the Program a copy of this License along with the Program.

You may charge a fee for the physical act of transferring a copy, and you may at your option offer warranty protection in exchange for a fee.

2. You may modify your copy or copies of the Program or any portion of it, thus forming a work based on the Program, and copy and distribute such modifications or work under the terms of Section 1 above, provided that you also meet all of these conditions:

- a) You must cause the modified files to carry prominent notices stating that you changed the files and the date of any change.
- b) You must cause any work that you distribute or publish, that in whole or in part contains or is derived from the Program or any part thereof, to be licensed as a whole at no charge to all third parties under the terms of this License.
- c) If the modified program normally reads commands interactively when run, you must cause it, when started running for such interactive use in the most ordinary way, to print or display an announcement including an appropriate copyright notice and a notice that there is no warranty (or else, saying that you provide a warranty) and that users may redistribute the program under these conditions, and telling the user how to view a copy of this License. (Exception: if the Program itself is interactive but does not normally print such an announcement, your work based on the Program is not required to print an announcement.)

These requirements apply to the modified work as a whole. If identifiable sections of that work are not derived from the Program, and can be reasonably considered independent and separate works in themselves, then this License, and its terms, do not apply to those sections when you distribute them as separate works. But when you distribute the same sections as part of a whole which is a work based on the Program, the distribution of the whole must be on the terms of this License, whose permissions for other licensees extend to the entire whole, and thus to each and every part regardless of who wrote it.

Thus, it is not the intent of this section to claim rights or contest your rights to work written entirely by you; rather, the intent is to exercise the right to control the distribution of derivative or collective works based on the Program.

In addition, mere aggregation of another work not based on the Program with the Program (or with a work based on the Program) on a volume of a storage or distribution medium does not bring the other work under the scope of this License.

3. You may copy and distribute the Program (or a work based on it, under Section 2) in object code or executable form under the terms of Sections 1 and 2 above provided that you also do one of the following:

- a) Accompany it with the complete corresponding machine-readable source code, which must be distributed under the terms of Sections 1 and 2 above on a medium customarily used for software interchange; or,
- b) Accompany it with a written offer, valid for at least three years, to give any third party, for a charge no more than your cost of physically performing source distribution, a complete machine-readable copy of the corresponding source code, to be distributed under the terms of Sections 1 and 2 above on a medium customarily used for software interchange; or,
- c) Accompany it with the information you received as to the offer to distribute corresponding source code. (This alternative is allowed only for noncommercial distribution and only if you received the program in object code or executable form with such an offer, in accord with Subsection b above.)

The source code for a work means the preferred form of the work for making modifications to it. For an executable work, complete source code means all the source code for all modules it contains, plus any associated interface definition files, plus the scripts used to control compilation and installation of the executable. However, as a special exception, the source code distributed need not include anything that is normally distributed (in either source or binary form) with the major components (compiler, kernel, and so on) of the operating system on which the executable runs, unless that component itself accompanies the executable.

If distribution of executable or object code is made by offering access to copy from a designated place, then offering equivalent access to copy the source code from the same place counts as distribution of the source code, even though third parties are not compelled to copy the source along with the object code.

4. You may not copy, modify, sublicense, or distribute the Program except as expressly provided under this License. Any attempt otherwise to copy, modify, sublicense or distribute the Program is void, and will automatically terminate your rights under this License.

However, parties who have received copies, or rights, from you under this License will not have their licenses terminated so long as such parties remain in full compliance.

5. You are not required to accept this License, since you have not signed it. However, nothing else grants you permission to modify or distribute the Program or its derivative works. These actions are prohibited by law if you do not accept this License. Therefore, by modifying or distributing the Program (or any work based on the Program), you indicate your acceptance of this License to do so, and all its terms and conditions for copying, distributing or modifying the Program or works based on it.

6. Each time you redistribute the Program (or any work based on the Program), the recipient automatically receives a license from the original licensor to copy, distribute or modify the Program subject to these terms and conditions. You may not impose any further restrictions on the recipients' exercise of the rights granted herein. You are not responsible for enforcing compliance by third parties to this License.

7. If, as a consequence of a court judgment or allegation of patent infringement or for any other reason (not limited to patent issues), conditions are imposed on you (whether by court order, agreement or otherwise) that contradict the conditions of this License, they do not excuse you from the conditions of this License. If you cannot distribute so as to satisfy simultaneously your obligations under this License and any other pertinent obligations, then as a consequence you may not distribute the Program at all. For example, if a patent license would not permit royalty-free redistribution of the Program by all those who receive copies directly or indirectly through you, then the only way you could satisfy both it and this License would be to refrain entirely from distribution of the Program.

If any portion of this section is held invalid or unenforceable under any particular circumstance, the balance of the section is intended to apply and the section as a whole is intended to apply in other circumstances.

It is not the purpose of this section to induce you to infringe any patents or other property right claims or to contest validity of any such claims; this section has the sole purpose of protecting the integrity of the free software distribution system, which is implemented by public license practices. Many people have made generous contributions to the wide range of software distributed through that system in reliance on consistent application of that system; it is up to the author/donor to decide if he or she is willing to distribute software through any other system and a licensee cannot impose that choice.

This section is intended to make thoroughly clear what is believed to be a consequence of the rest of this License.

8. If the distribution and/or use of the Program is restricted in certain countries either by patents or by copyrighted interfaces, the original copyright

holder who places the Program under this License may add an explicit geographical distribution limitation excluding those countries, so that distribution is permitted only in or among countries not thus excluded. In such case, this License incorporates the limitation as if written in the body of this License.

9. The Free Software Foundation may publish revised and/or new versions of the General Public License from time to time. Such new versions will be similar in spirit to the present version, but may differ in detail to address new problems or concerns.

Each version is given a distinguishing version number. If the Program specifies a version number of this License which applies to it and “any later version”, you have the option of following the terms and conditions either of that version or of any later version published by the Free Software Foundation. If the Program does not specify a version number of this License, you may choose any version ever published by the Free Software Foundation.

10. If you wish to incorporate parts of the Program into other free programs whose distribution conditions are different, write to the author to ask for permission. For software which is copyrighted by the Free Software Foundation, write to the Free Software Foundation; we sometimes make exceptions for this. Our decision will be guided by the two goals of preserving the free status of all derivatives of our free software and of promoting the sharing and reuse of software generally.

NO WARRANTY

11. BECAUSE THE PROGRAM IS LICENSED FREE OF CHARGE, THERE IS NO WARRANTY FOR THE PROGRAM, TO THE EXTENT PERMITTED BY APPLICABLE LAW. EXCEPT WHEN OTHERWISE STATED IN WRITING THE COPYRIGHT HOLDERS AND/OR OTHER PARTIES PROVIDE THE PROGRAM “AS IS” WITHOUT WARRANTY OF ANY KIND, EITHER EXPRESSED OR IMPLIED, INCLUDING, BUT NOT LIMITED TO, THE IMPLIED WARRANTIES OF MERCHANTABILITY AND FITNESS FOR A PARTICULAR PURPOSE. THE ENTIRE RISK AS TO THE QUALITY AND PERFORMANCE OF THE PROGRAM IS WITH YOU. SHOULD THE PROGRAM PROVE DEFECTIVE, YOU ASSUME THE COST OF ALL NECESSARY SERVICING, REPAIR OR CORRECTION.

12. IN NO EVENT UNLESS REQUIRED BY APPLICABLE LAW OR AGREED TO IN WRITING WILL ANY COPYRIGHT HOLDER, OR ANY OTHER PARTY WHO MAY MODIFY AND/OR REDISTRIBUTE THE PROGRAM AS PERMITTED ABOVE, BE LIABLE TO YOU FOR DAMAGES, INCLUDING ANY GENERAL, SPECIAL, INCIDENTAL OR CONSEQUENTIAL DAMAGES ARISING OUT OF THE USE OR INABILITY TO USE THE PROGRAM (INCLUDING BUT NOT LIMITED TO LOSS OF DATA OR DATA BEING RENDERED INACCURATE OR LOSSES SUSTAINED BY YOU OR THIRD PARTIES OR A FAILURE OF THE PROGRAM TO OPERATE WITH ANY OTHER PROGRAMS), EVEN IF SUCH HOLDER OR OTHER PARTY HAS BEEN ADVISED OF THE POSSIBILITY OF SUCH DAMAGES.

END OF TERMS AND CONDITIONS

How to Apply These Terms to Your New Programs

If you develop a new program, and you want it to be of the greatest possible use to the public, the best way to achieve this is to make it free software which everyone can redistribute and change under these terms.

To do so, attach the following notices to the program. It is safest to attach them to the start of each source file to most effectively convey the exclusion of warranty; and each file should have at least the “copyright” line and a pointer to where the full notice is found.

<one line to give the program's name and a brief idea of what it does.>

Copyright (C) <year> <name of author>

This program is free software; you can redistribute it and/or modify it under the terms of the GNU General Public License as published by the Free Software Foundation; either version 2 of the License, or (at your option) any later version.

This program is distributed in the hope that it will be useful, but WITHOUT ANY WARRANTY; without even the implied warranty of MERCHANTABILITY or FITNESS FOR A PARTICULAR PURPOSE. See the GNU General Public License for more details.

You should have received a copy of the GNU General Public License along with this program; if not, write to the Free Software Foundation, Inc., 51 Franklin Street, Fifth Floor, Boston, MA 02110-1301 USA.

Also add information on how to contact you by electronic and paper mail.

If the program is interactive, make it output a short notice like this when it starts in an interactive mode:

Gnomovision version 69, Copyright (C) year name of author

Gnomovision comes with ABSOLUTELY NO WARRANTY; for details type `show w'. This is free software, and you are welcome to redistribute it under certain conditions; type `show c' for details.

The hypothetical commands `show w' and `show c' should show the appropriate parts of the General Public License. Of course, the commands you use may be called something other than `show w' and `show c'; they could even be mouse-clicks or menu items--whatever suits your program.

You should also get your employer (if you work as a programmer) or your school, if any, to sign a “copyright disclaimer” for the program, if necessary. Here is a sample; alter the names:

Yoyodyne, Inc., hereby disclaims all copyright interest in the program `Gnomovision' (which makes passes at compilers) written by James Hacker.

<signature of Ty Coon>, 1 April 1989 Ty Coon, President of Vice

This General Public License does not permit incorporating your program into proprietary programs. If your program is a subroutine library, you may consider it more useful to permit linking proprietary applications with the library. If this is what you want to do, use the GNU Lesser General Public License instead of this License.

