

Major

MANUFACTURING, INC.

1825 VIA BURTON
ANAHEIM CA 92806
714-772-5202 / FAX 714-772-2302
EMAIL: MAIL@MAJORMFG.COM
WEB: WWW.MAJORMFG.COM

INSTRUCTIONS FOR HIT-45 MORTISE LOCK INSTALLATION

WHEN USING POWER TOOLS
ALWAYS WEAR
EYE AND EAR PROTECTION!!

Use the HIT-45
clamp system to
route faceplate
openings in
wood doors.



PREPARE YOUR HIT-45 CLAMP

Using your left hand (if you are right handed) squeeze together the spring loaded jaws of the HIT-45 clamp to release the spring pressure.



Loosen the black plastic knob until you can rotate the vise block 180 degrees, this will allow it to rotate freely. Repeat this procedure with the other end of the clamp.



The clamp heads will now spin left to right. This will allow the clamp to align to the door bevel.



Attach the bevel blocks both top and bottom on the inside of the HIT-45 clamp with the supplied 10-32 x 1/2" flat head socket screws. These blocks pick up the door bevel.

THE BLOCKS MUST BE REMOVED WHEN DRILLING THE LOCK FUNCTION HOLES LATER OR IF USING THIS CLAMP ON ALUMUNUM DOORS! FAILURE TO REMOVE THEM WILL CAUSE THE LOCK BACKSET TO BE MIS-DRILLED.



Thread the pointer in the center hole of the five tapped holes as shown.

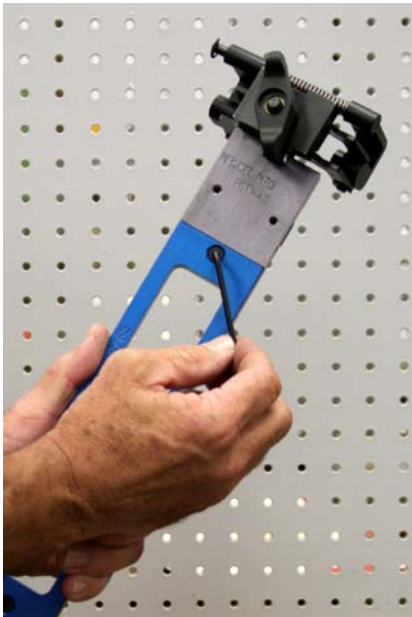

Install the HIT-45AR5 template using the supplied 10-32 x 1/2" long flat head socket screws. Using a 5/8" router template guide and a 1/2" router bit, this template will route a 1-1/4" wide x 8" tall faceplate.

SET UP YOUR ROUTER



Set up your router by installing a 5/8" outside diameter template guide and a 1/2" diameter router bit. Start by extending the router bit 1-1/16" past the base plate and test. This will be very close to the proper depth. It is best to test on a scrap wood block prior to installation. By measuring the distance from the router base to the end of the router bit, this set up can now be duplicated at any time.



To center the template we must find the center of the lock mortise. Using a combination square, make a pencil line at the top and bottom of the mortise as shown.



Pencil mark at top of lock mortise, mark the bottom the same way.



Measure the distance between the top and bottom of the mortise and divide by two.



Make a mark at this point, this will be the center of the mortise pocket and the center of the mortise faceplate.



Hold the HIT-45 to the door with the locating pointer pointing to the center line, allow the bevel blocks to conform the door bevel and tighten clamps. Double check the pointer is located to center and remove the pointer.

Failure to remove the pointer will result in it being struck by the router bit.



ROUTE THE OPENING

With the router bit adjusted to the proper depth and the HIT-45 clamp and template properly located, place the router in the template guide with the bit extending into the mortise pocket. Using both hands for control, turn on the router and route the opening in a clockwise direction. **When completed, let the router come to a complete stop before removing it from the template. FAILURE TO DO SO MAY CAUSE DAMAGE TO YOUR TEMPLATE, THE DOOR OR INJURY TO YOURSELF.** Check the work area and make a clean up pass if needed.



When completed, remove the clamp from the door and square the corners with a chisel.

Shown is the use of a corner squaring chisel.



Use a standard chisel to finish removing the round corners and final cleanup.



Finished faceplate ready for the mortise lock installation.

That's all there is to it!

If using your HIT-45 clamp for drilling the function holes, don't forget to remove the bevel blocks and turn the clamp blocks back to the locked position.

Visit our web site at www.majormfg.com for more information or router recommendations, template guides and other templates to make your installations easier and faster. While there sign up for our newsletter and we will email new product information directly to you.

Using the HIT-45 clamping system to install mortise locks.

The HIT-45 modular clamping system utilizes a unique design that is both self aligning and self centering on all types of doors. The HIT-45 uses two internal locating studs that always assures that the backset is located from the center of the door edge regardless of the door type or the door edge encountered (flat, beveled or radius door edge). With the appropriate templates installed, the HIT-45 can be used to route lock openings in aluminum frames or install mortise locks on wood and hollow metal doors. To setup your job simply attach the appropriate templates to the HIT-45 modular clamp and tighten the assembly to the door. Remember, clamping pressure is always positive and therefore moderate clamping torque applied to the clamping knobs is all that is needed.



This is the HIT-45 clamp that will be used to install a mortise lock. It can be used to install a variety of hardware using interchangeable templates.

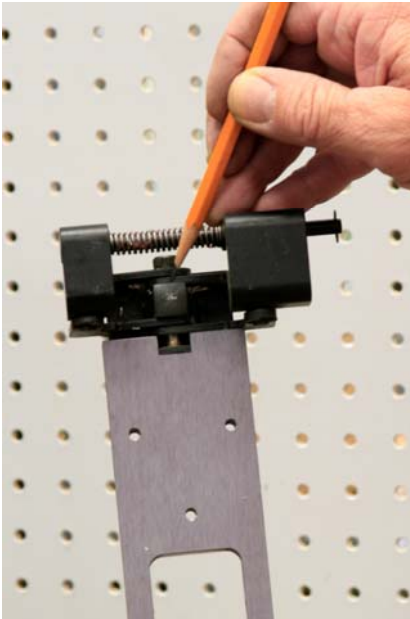

There is a backset stud located in the center of the top and bottom clamp. It will set the correct backset calculated from the center of the door regardless of door bevel.

NOTE: IF YOU HAVE USED THIS CLAMP TO ROUTE THE FACEPLATE—BE SURE TO REMOVE THE BEVEL BLOCKS, FAILURE TO DO SO WILL RESULT IN A MIS-DRILLED DOOR.



When attaching the mortise lock template to the clamp, be sure the center hole of the template is fastened to the center hole of the clamp.



Shown is the HIT-45ML1 alignment fixture. This is used to align the function holes used by the mortise lock to the correct location in the mortise pocket. It will work with any of our mortise lock templates that use a 1-1/4" wide by a 8" tall faceplate.



One half of the template will screw to the face of the HIT-45 clamp as shown. Be sure to use the shorter (1/2" long) of the screws supplied.



The second half of the template will attach to the faceplate area. Use a self centering drill to locate the screw holes required by the mortise lock. This will help with alignment and prevent binds when the lock is installed. Use the factory supplied screws to attach to the door.





To attach the clamp, just slide over the post and tighten to the door.



Working from one side of the door, drill all holes that are required for the lock function you are using. Drill holes that go through the door only half way. The back of this manual will identify hole locations and sizes. All large holes will be piloted with a 1/4" drill bit and enlarged with a hole saw once the clamp is removed.

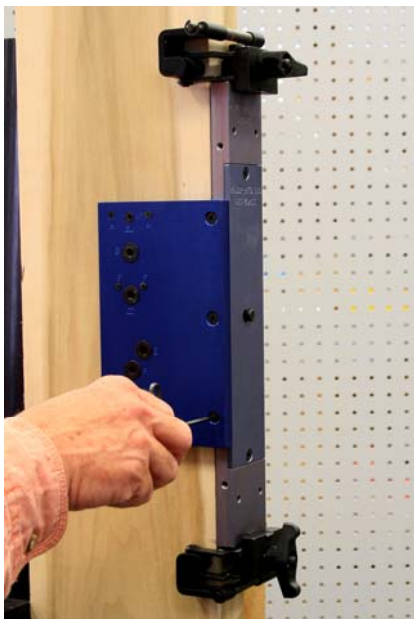

This clamp can be used with one or two templates. If using only one template prep one side of the door and with the clamp still in position, remove the template and install on the other side.



Once all holes and pilot holes have been drilled, enlarge per the mortise lock specifications. In this example the spindle hole is being enlarged from the 1/4" pilot hole to the required 1-1/8" size. Drill all other holes in the same manner.

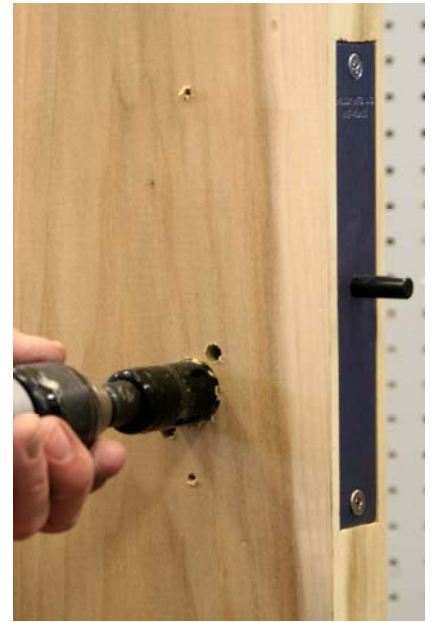

Remove HIT-45ML1 guide from the faceplate pocket.



Completed installation, install mortise lock per factory instructions.

That's all there is to it!!

ALARM LOCK MORTISE LOCK HIT-45AL1 TEMPLATE GUIDE

FOR USE WITH ALARM LOCK DL3500 MORTISE LOCK

USE MARKED HOLES AS FOLLOWS:

(A) FOR THRU BOLT HOLES.

Drill half way from both sides of door. Template hole size: 3/8"
Total of six holes to be drilled.

(B1) FOR WIRE HARNESS - NON FIRE RATED DOOR

(B2) FOR WIRE HARNESS - FIRE RATED DOOR

Drill half way from both sides of door. Template hole size: 1/4".
Enlarge hole to 3/4" with a hole saw after all holes are drilled and
HIT-45 has been removed from door.

(C) FOR MORTISE CYLINDER HOLE. DRILL ONLY ON OUTSIDE OF DOOR.

Drill to mortise pocket only. Template hole size: 1/4". Enlarge
hole to 1-1/4" with a hole saw after all holes are drilled and HIT-45
has been removed from door.

(D) TURNPIECE HOLE DB MODEL ONLY.

Drill only on inside of door to mortise pocket only.
Template hole size: 1/2".

(E) FOR LEVER SPINDLE HOLE

Drill to mortise pocket from both sides of door.
Template hole size: 1/4".
Enlarge hole to 1-1/4" with a hole saw after all holes are drilled and
The HIT-45 has been removed from door.



ALWAYS WEAR EYE AND EAR PROTECTION WHEN USING POWER TOOLS!

IMPORTANT: If using HIT-45 Clamp for faceplate routing you must remove bevel blocks prior to drilling function holes. Failure to do so will result in incorrect backset.

Major

MANUFACTURING, INC. (714) 772-5202 FAX (714) 772-2302

ARROW MORTISE LOCK HIT-45AW3 TEMPLATE GUIDE

FOR ARROW AM & BM SERIES MORTISE LOCKS WITH THRU-BOLTED ESCUTCHEON, WROUGHT AND ROSE TRIM, USED IN CONJUNCTION WITH FACTORY PAPER TEMPLATE AND DIRECTIONS.

USE MARKED HOLES AS FOLLOWS:

(A) FOR ESCUTCHEON TRIM.

Drill only if using H escutcheon trim.
Template hole size: 3/8", drill half way from both sides of door.

(B) FOR MORTISE CYLINDER

Drill only on side of door with a mortise cylinder.
Template hole size: 1/4", drill only to mortise pocket.
Enlarge hole to 1-1/4" with a hole saw.

(C) FOR THUMB TURN

Drill only on side of door with a thumb turn.
Template hole size: 1/4", drill only to mortise pocket.
Enlarge hole to 5/8" for rose trim or to 13/16" for escutcheon trim.
Hole "C" is also used on outside door if installing 02 privacy function.
Template hole size: 1/4", drill only to mortise pocket.
Enlarge hole to 5/8" with a hole saw.

(D) FOR KNOB OR LEVER THRU-BOLT HOLES

Drill only on side of door with a knob or lever.
Template hole size: 3/8", drill only to mortise pocket.

(E) FOR KNOB OR LEVER SPINDLE HOLE

Drill only on side of door with a knob or lever.
Template hole size: 1/4", drill only to mortise pocket.
Enlarge hole to 7/8" with a hole saw.

(F) FOR SURFACE APPLIED WROUGHT TRIM.

Match trim to drill guide. Drill only if using wrought trim.
Drill template size is 1/16". Redrill to proper diameter for wood or Steel door. In wood door drill only to the length of screw used.



ALWAYS WEAR EYE AND EAR PROTECTION WHEN USING POWER TOOLS!

IMPORTANT: If using HIT-45 Clamp for faceplate routing you must remove bevel blocks prior to drilling function holes. Failure to do so will result in incorrect backset.

Major

MANUFACTURING, INC. (714) 772-5202 FAX (714) 772-2302

BEST MORTISE LOCK HIT-45BE7 TEMPLATE GUIDE

FOR USE WITH BEST 30H MORTISE LOCKS
WITH "M" AND "N" STYLE FORGED TRIM

USE MARKED HOLES AS FOLLOWS:

1) FOR MORTISE CYLINDER

Drill only using the side of the door that has a mortise cylinder.
Template hole size: 1/4", drill only to mortise pocket.
Enlarge hole to 1-1/4" with a hole saw.

(2) FOR THUMB TURN OR EMERGENCY ENTRANCE

Drill only on side of door with a thumb turn or emergency entrance.
Template hole size: 1/4", drill only to mortise pocket.
Enlarge hole to 1/2" with a twist drill.

(4) FOR KNOB OR LEVER SPINDLE

Drill only on side of door with a knob or lever.
Template hole size: 1/4", drill only to mortise pocket.
Enlarge hole to 7/8" with a hole saw.

(5) FOR THRU-BOLT HOLES

Drill only on side of door with a knob or lever.
Template hole size: 13/8", drill to mortise pocket.

(6) FOR FORGED ESCUTCHEON TRIM

Drill only if using escutcheon trim.
Template hole size: Top hole 5/32", bottom hole 1/4". Drill
half way from both sides of door. Enlarge both holes to
9/16" with a hole saw,

(7) FOR "J" SERIES WROUGHT TRIM

Drill only if using "J" wrought trim.
Template hole size: 5/32", drill half way from both sides of door.
Enlarge hole to 3/8" with a twist drill.

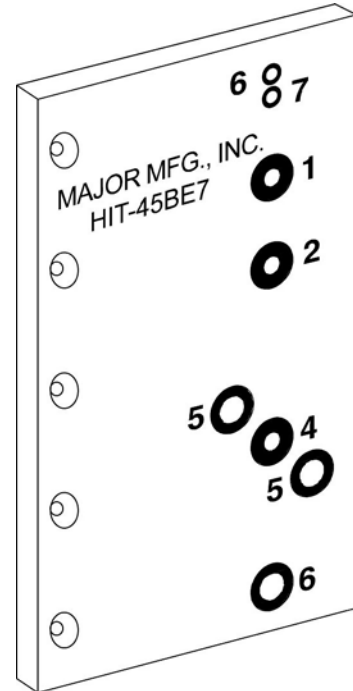

ALWAYS WEAR EYE AND EAR PROTECTION WHEN USING POWER TOOLS!

NOTE: THE NUMBERS ON THIS TEMPLATE CORRESPONDS TO BEST ACCESS SYSTEMS (formerly Best Lock Corporation) HOLE PATTERN CHART FOR 30H MORTISE LOCKS. TEMPLATE #HO4.

VISIT OUR WEBSITE!

www.majormfg.com

Major

MANUFACTURING, INC. (714) 772-5202 FAX (714) 772-2302

BALDWIN MORTISE LOCK HIT-45BH1 TEMPLATE GUIDE

FOR USE WITH TRIM AS INSTALLED WITH BALDWIN SUPPLIED PAPER TEMPLATE FORM #PK-1076B (6-93)
EXCLUDING MORTISE LOCK SERIES 8550, 8555 AND 8560. REFER TO BALDWIN SUPPLIED BLUE INSTALLATION TEMPLATE
GUIDE CHART FORM #PK-1076C (10-93) TO DETERMINE HOLE PATTERN TO DRILL ON DOOR.

NOTE: THIS TEMPLATE WILL DRILL HOLES AT FOUR DIFFERENT BACKSETS. BE SURE TO CHECK THE BACKSET OF THE LOCK YOU ARE INSTALLING. WHEN CHANGING THE TEMPLATE FROM ONE SIDE OF THE DOOR TO THE OTHER BE SURE TO USE SAME BACKSET AS USED ON THE OTHER SIDE. FAILURE TO DO SO WILL RESULT IN A MISDRILLED DOOR. THE HOLES USED TO ATTACH BACKSETS 1-1/2" AND 2-1/2" ARE NOT ALL LOCATED IN A STRAIGHT LINE ON THE TEMPLATE. THEY ARE OFFSET AND USE THE TWO BOTTOM HOLES OF THE HIT-45 CLAMP. ALL BACKSETS ARE MARKED AND LINES CONNECT THE CORRECT HOLES TO USE.

USE MARKED HOLES AS FOLLOWS:

1) FOR ESCUTCHEON TRIM

Drill only if using escutcheon trim.
Template hole size: 1/4", drill half way from both sides of door.
Enlarge hole to 1/2" after all other holes are drilled and HIT-45 clamp
Has been removed from door.

(2) FOR MORTISE CYLINDER

Drill only on side of door that has a mortise cylinder.
Template hole size: 1/4", drill only to mortise pocket.
Enlarge hole to 1-1/4" with a hole saw.

(3) FOR TURN-KNOB

Drill only on side of door with a turn knob.
Template hole size: 1/4", drill only to mortise pocket.
Enlarge hole to 5/8" with a hole saw.

(4) FOR KNOB OR LEVER SPINDLE

Drill to mortise pocket from both sides of door.
Template hole size: 1/4".
Enlarge to 3/4" with a hole saw.

(5) THUMB PIECE HOLE

Drill only on side of door with a thumb piece.
Template hole size: 1/4".
Enlarge to 1" with a hole saw.

CONTINUED.....

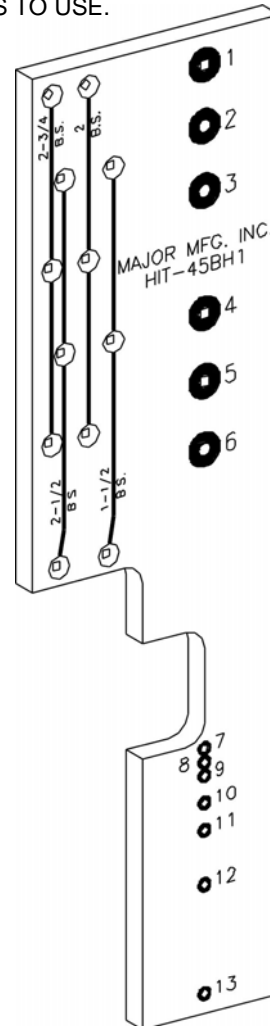

ALWAYS WEAR EYE AND EAR PROTECTION WHEN USING POWER TOOLS!

IMPORTANT: If using HIT-45 Clamp for faceplate routing you must remove bevel blocks prior to drilling function holes. Failure to do so will result in incorrect backset.

Major
ANUFACTURING, INC.

VISIT OUR WEBSITE!

(714) 772-5202 FAX (714) 772-2302

HIT-45BH1 TEMPLATE GUIDE (cont'd.)

6) TOP PULL THROUGH-BOLT, ESCUTCHEON TRIM HOLE OR THUMB PIECE COUNTER BORE.

Template hole size: 1/4".

For top pull through bolt; enlarge to 5/16" *ONLY AFTER DRILLING COUNTER BORE ON OUTSIDE OF DOOR, IF USING THUMB PIECE EQUIPPED TRIM.*

Drill counter bore with a 1" hole saw to a depth of 5/16", connect lines to the 1" thumb piece hole above and chisel area out to allow clearance for the thumb piece assembly.

For escutcheon trim, enlarge to 1/2" with a twist drill.

USE MARKED HOLES AS FOLLOWS:

(7 TO 13) THROUGH-BOLT HOLES FOR PULLS. Determine center-to-center distance by using blue trim chart supplied by Baldwin; or By measuring the distance on the actual lock.

Template hole size: 9/64" drill, drill halfway from both sides of the Door. Enlarge hole to 5/16" with the use of a twist drill. Center-to-Center dimensions for holes as follows:

- (7) 5-1/2" Center to center.
- (8) 5-3/4" Center to center.
- (9) 6" Center to center.
- (10) 6-1/2" Center to center.
- (11) 7" Center to center.
- (12) 8" Center to center.
- (13) 10" Center to center.

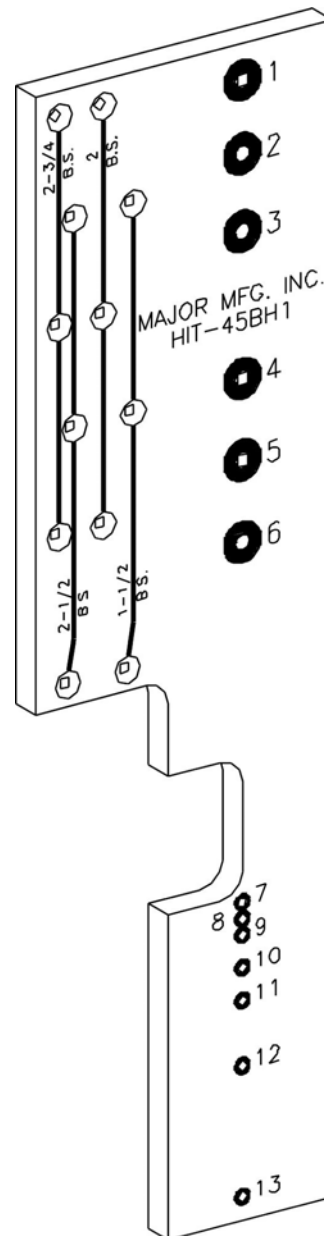

ALWAYS WEAR EYE AND EAR PROTECTION WHEN USING POWER TOOLS!

IMPORTANT: If using HIT-45 Clamp for faceplate routing you must remove bevel blocks prior to drilling function holes. Failure to do so will result in Incorrect backset.

VISIT OUR WEBSITE!

www.majormfg.com

Major
MANUFACTURING, INC.

(714) 772-5202 FAX (714) 772-2302

CORBIN/RUSSWIN MORTISE LOCK HIT-45CR1 TEMPLATE GUIDE

FOR ML220 SERIES MORTISE LOCKS WITH ROSETTE TRIM
OR "M" SERIES ESCUTCHEON TRIM. THIS TEMPLATE TO BE USED IN
CONJUNCTION WITH FACTORY PAPER TEMPLATE AND DIRECTIONS.

USE MARKED HOLES AS FOLLOWS:

(A) FOR ESCUTEON THRU BOLTS

Drill only using "M" series escutcheon trim.
Template hole size: 3/16".

(B) FOR MORTISE CYLINDER

Drill only on side of door that has cylinder
Template hole size: 1/4", drill only to mortise pocket.
Enlarge hole to 1-1/4" with a hole saw.

(C) FOR THUMB TURN MOUNTING HOLES

Drill only on side of door with turn thumb.
Template hole size: 1/16", drill only to mortise pocket.

(D) FOR THUMB TURN OR LOCK INDICATOR

Drill only on side of door with thumb turn or lock indicator.
Template hole size: 1/4", drill only to mortise pocket.

(E) FOR THRU BOLT HOLES

Drill only on side of door with a knob or lever.
Template hole size: 5/16", drill only to mortise pocket.

(F) FOR KNOB OR LEVER SPINDLE HOLE

Drill only on side of door with a knob or lever.
Template hole size: 1/4", drill only to mortise pocket.
Enlarge hole to 3/4" with a hole saw.

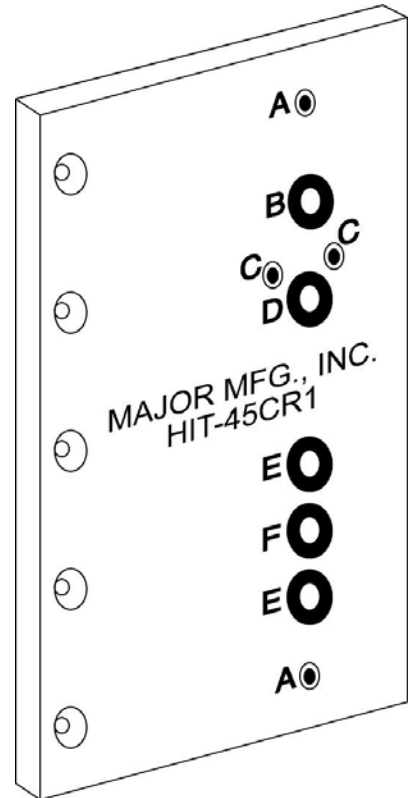

ALWAYS WEAR EYE AND EAR PROTECTION WHEN USING POWER TOOLS!

IMPORTANT: If using HIT-45 Clamp for faceplate routing you must remove bevel blocks prior to drilling function holes. Failure to do so will result in incorrect backset.

VISIT OUR WEBSITE!

www.majormfg.com

Major

MANUFACTURING, INC. (714) 772-5202 FAX (714) 772-2302

FALCON MORTISE LOCK HIT-45FL4 TEMPLATE GUIDE

FOR MORTISE LOCKS WITH LM, MM OR SM TRIM USED IN CONJUNCTION
WITH FACTORY PAPER TEMPLATE AND DIRECTIONS

USE MARKED HOLES AS FOLLOWS

(A) FOR ESCUTCHEON TRIM

Drill only for cast/forged escutcheon trim.

Template hole size: 1/4", drill half way from both sides of the door.

Enlarge hole to 19/32" with a hole saw.

(B) FOR MORTISE CYLINDER

Drill only on the side of the door that has cylinder.

Template hole size: 1/4", drill only to mortise pocket.

Enlarge hole to 1-1/4" with a hole saw.

(C) FOR THUMB TURN OR LOCK INDICATOR

Drill only on side of door with thumb turn or lock indicator.

Template hole size: 1/4", drill only to mortise pocket.

Enlarge hole to 1/2".

(D) FOR THRU BOLT HOLES

Drill only on side of door with a knob or lever.

Template hole size: 3/8". Drill only to mortise pocket.

(E) FOR KNOB OR LEVER SPINDLE HOLE

Drill only on side of door with a knob or lever.

Template hole size: 1/4", drill only to mortise pocket.

Enlarge hole to 1-1/8" with a hole saw.



ALWAYS WEAR EYE AND EAR PROTECTION WHEN USING POWER TOOLS!

IMPORTANT: If using HIT-45 Clamp for faceplate routing you must remove bevel blocks prior to drilling function holes. Failure to do so will result in Incorrect backset.

Major
MANUFACTURING, INC.

VISIT OUR WEBSITE!

www.majormfg.com

(714) 772-5202 FAX (714) 772-2302

HIT-45LN2 TEMPLATE GUIDE

FOR USE WITH LOCKNETICS CM5500
SERIES MORISE LOCKS

USE MARKED HOLES AS FOLLOWS FOR LH OR LHR DOORS:

(A) FOR THRU-BOLT STANDOFF

Template hole size: 3/8", drill half way from both sides of door.

(B) FOR WIRE HARNESS.

Template hole size: 1/4", drill half way from both sides of door.
Enlarge hole to 1" with a hole saw after all holes are drilled and
HIT-45 has been removed from door.

(C) FOR PRIVACY OPTION ONLY.

Template hole size: 1/4", drill only to a depth of 1" on inside of door
only to a depth of 1" on inside of door only. **DO NOT DRILL
THROUGH DOOR.** Enlarge hole to 3/4" with a hole saw to the
same depth after all holes are drilled and HIT-45 has been
removed from door. Using the 3/4" saw hole as a guide, remove
all wood inside with a chisel to form a pocket.

(D) FOR THRU-BOLT STANDOFF

Template hole size: 3/8".
Drill half way from both sides of door.

(E) LEVER HOLE

Drill to mortise pocket from both sides of door.
Template hole size: 1/4".
Enlarge hole to 3/4" with a hole saw after all holes are
drilled and HIT-45 has been removed from door.

(F) LOWER THRU-BOLT STANDOFFS

Template hole size: 3/8".
Drill half way from both sides of door.

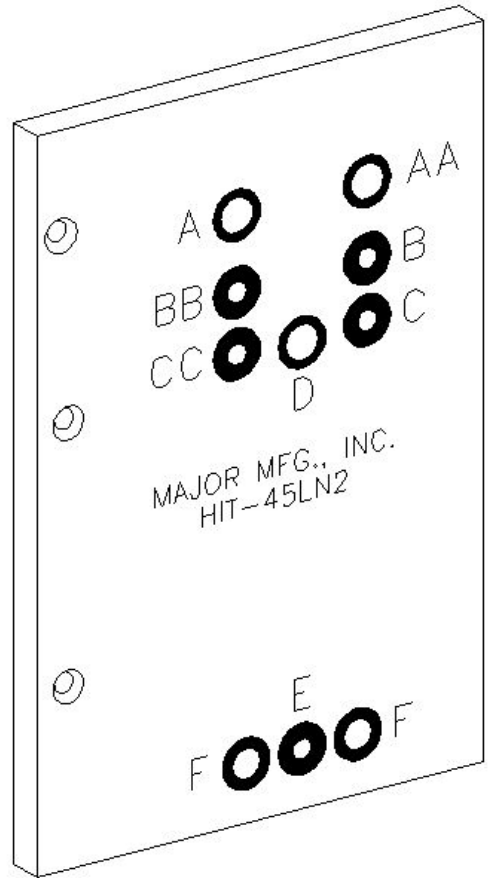

Continued.....

ALWAYS WEAR EYE AND EAR PROTECTION WHEN USING POWER TOOLS!

*IMPORTANT: If using HIT-45 Clamp for faceplate routing you must remove
bevel blocks prior to drilling function holes. Failure to do so will result in
Incorrect backset.*

Major
MANUFACTURING, INC.

VISIT OUR WEBSITE!

www.majormfg.com

(714) 772-5202 FAX (714) 772-2302

HIT-45LN2 TEMPLATE GUIDE (cont.'d)

FOR USE WITH LOCKNETICS CM5500
SERIES MORISE LOCKS

USE MARKED HOLES AS FOLLOWS FOR RH OR RHR DOORS:

(AA) FOR THRU-BOLT STANDOFF.

Template hole size: 3/8", drill half way from both sides of door.

(BB) FOR WIRE HARNESS.

Template hole size: 1/4", drill half way from both sides of door.
Enlarge hole to 1" with a hole saw after all holes are drilled and
HIT-45 has been removed from door.

(CC) FOR PRIVACY OPTION ONLY.

Template hole size: 1/4", drill only to a depth of 1" on inside of door
only to a depth of 1" on inside of door only. **DO NOT DRILL
THROUGH DOOR.** Enlarge hole to 3/4" with a hole saw to the
same depth after all holes are drilled and HIT-45 has been
removed from door. Using the 3/4" saw hole as a guide, remove
all wood inside with a chisel to form a pocket.

(D) FOR THRU-BOLT STANDOFF

Template hole size: 3/8".
Drill half way from both sides of door,

(E) LEVER HOLES.

Drill to mortise pocket from both sides of door.
Template hole size: 1/4".
Enlarge hole to 3/4" with a hole saw after all holes are drilled
and HIT-45 has been removed from door.

(F) LOWER THRU-BOLT STANDOFFS

Template hole size: 3/8".
Drill half way from both sides of door.

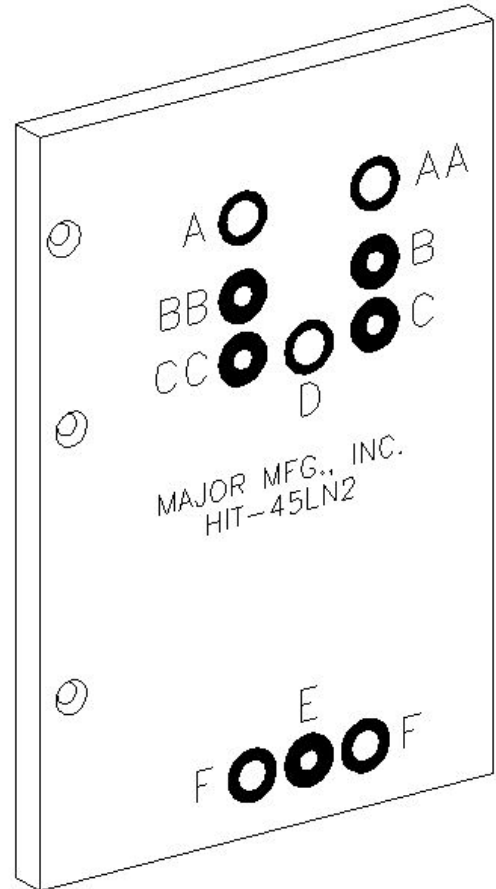

ALWAYS WEAR EYE AND EAR PROTECTION WHEN USING POWER TOOLS!

*IMPORTANT: If using HIT-45 Clamp for faceplate routing you must remove
bevel blocks prior to drilling function holes. Failure to do so will result in
Incorrect backset.*

Major
MANUFACTURING, INC.

VIST OUR WEBSITE!

www.majormfg.com

(714) 772-5202 FAX (714) 772-2302

MARKS MORTISE LOCK HIT-45MK5 TEMPLATE GUIDE

FOR USE WITH MARKS 5220, 5260, 5600, 5610, 5620, 5630, 5640, 5650, 5660, 5670, 5680, 5690, 5695,
NYC126 AND NYC131 SERIES KNOB OR LEVER ROSE TRIM MORTISE LOCKS

-OR-

5300, 5370, 5380, 5390, 5395, 5700 AND 5710 KNOB OR LEVER PLATE TRIM MORTISE LOCKS.

USE MARKED HOLES AS FOLLOWS

(A) FOR ESCUTCHEON TRIM

Drill only if using escutcheon trim.
Template hole size: 3/8", drill half way from both sides of door.

(B) FOR MORTISE CYLINDER

Drill only on the side of door that has a mortise cylinder.
Template hole size: 1/4", drill only to mortise pocket.
Enlarge hole to 1-1/4" with a hole saw.

(C) FOR THUMB TURN

Drill only on side of door with thumb turn.
Template hole size: 1/4", drill only to mortise pocket.
Enlarge hole to 1/2" for rose trim or to 7/8" for escutcheon trim.

(D) FOR ROSE MOUNTED THUMB TURN

Drill only on side of door with a rose mounted thumb turn.
Template hole size: 1/16", drill to a depth of 1/4". Not required
if using escutcheon trim.

(E) FOR ESCUTCHEON OR ROSE TRIM THRU-BOLT

For center thru-bolt of escutcheon trim or top thru-bolt hole of rose trim.
Template hole size: 3/8", drill half way from both sides of door.

(F) FOR KNOB OR LEVER SPINDLE HOLE.

Drill only on side of door with a knob or lever.
Template hole size: 1/4", drill only to mortise pocket.
Enlarge hole to 1" with a hole saw if installing rose trim or to
1-1/8" if installing escutcheon trim.

(G) FOR ROSE TRIM THRU-BOLT

Drill only if using rose trim.
Template hole size: 3/8", drill half way from both sides of door.

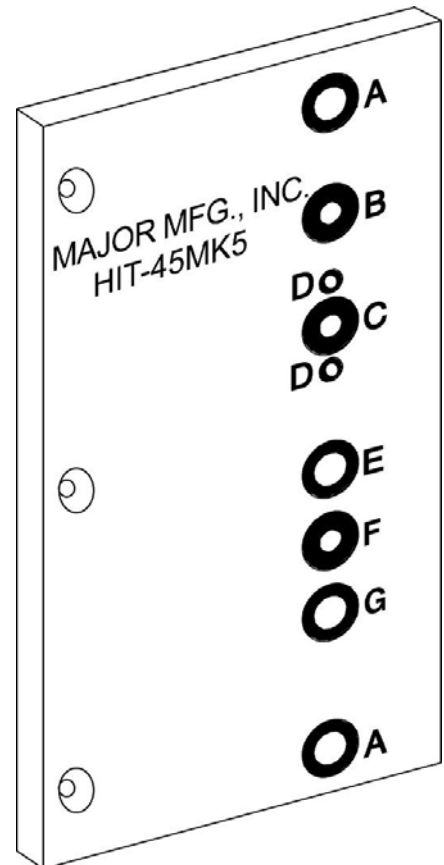

ALWAYS WEAR EYE AND EAR PROTECTION WHEN USING POWER TOOLS!

IMPORTANT: If using HIT-45 Clamp for faceplate routing you must remove bevel blocks prior to drilling function holes. Failure to do so will result in incorrect backset.

Major
MANUFACTURING, INC.

VISIT OUR WEBSITE!

www.majormfg.com

(714) 772-5202 FAX (714) 772-2302

PDQ MORTISE LOCK HIT-45PQ1 TEMPLATE GUIDE

FOR USE WITH PDQ MR CASE REVOLUTION MORTISE LOCKS
LETTERS ON HIT-45 TEMPLATE FOLLOW LETTERS ON PDQ
PAPER INSTALLATION TEMPLATE

USE MARKED HOLES AS FOLLOWS

(A) FOR THRU-BOLT ESCUTCHEON TRIM

Drill only if using thru-bolted escutcheon trim.
Template hole size: 1/4". Enlarge to 1/2" after all holes are drilled and HIT-45 has been removed from door.

(B) FOR MORTISE CYLINDER

Drill only on the side of door that has a mortise cylinder.
Template hole size: 1/4", drill only to mortise pocket.
Enlarge hole to 1-1/4" with a hole saw after all holes are drilled and HIT-45 has been removed from door.

(C) FOR TURNPIECE OR EMERGENCY TURNPIECE

Drill only on side of door that the turn piece or emergency turn piece is to be installed on.
Template hole size: 1/4", drill only to mortise pocket.
Enlarge hole to 9/16" with a hole saw after all holes are drilled and HIT-45 has been removed from the door.

(D) TURNPIECE OR EMERGENCY TURNPIECE MOUNTING SCREWS

Drill holes only if using trim that requires turn piece mounting holes.
Template hole size: 1/16". Enlarge hole to 7/64" with a twist drill after all holes are drilled and HIT-45 has been removed from door.

(E) FOR THRU-BOLT HOLES

Drill holes only if using thru-bolted trim.
Template hole size: 5/16". Drill to mortise pocket from both sides of door.

(F) LEVER HOLE

Drill to mortise pocket from both sides of door.
Template hole size: 1/4".
Enlarge hole to 1-1/8" with a hole saw after all holes are drilled and HIT-45 has been removed from door.

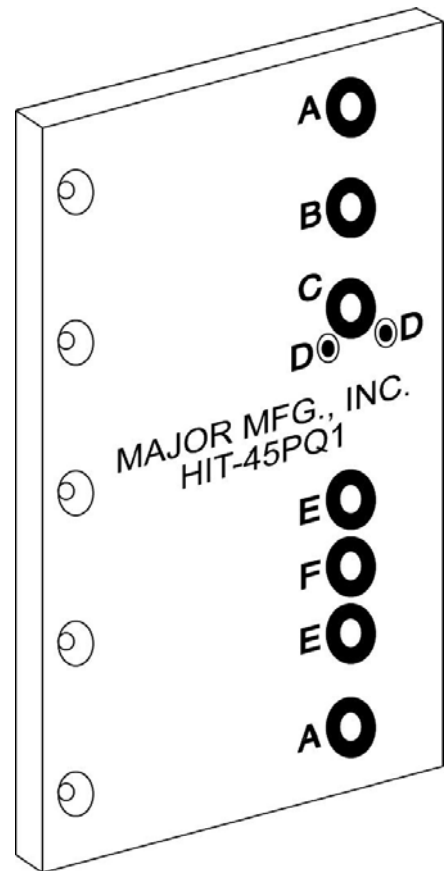

ALWAYS WEAR EYE AND EAR PROTECTION WHEN USING POWER TOOLS!

IMPORTANT: If using HIT-45 Clamp for faceplate routing you must remove bevel blocks prior to drilling function holes. Failure to do so will result in incorrect backset.

Major
MANUFACTURING, INC.

VISIT OUR WEBSITE!

www.majormfg.com

(714) 772-5202 FAX (714) 772-2302

SARGENT MORTISE LOCK HIT-45SA1 TEMPLATE GUIDE

FOR 8100 SERIES MORTISE LOCK WITH LE1, LE2, LE3, LE4, LW1 AND ROSETTE TRIM
USED IN CONJUNCTION WITH FACTORY PAPER TEMPLATE AND DIRECTIONS.

USE MARKED HOLES AS FOLLOWS

(A) FOR THRU-BOLT ESCUTCHEON TRIM

Drill only if using thru-bolted escutcheon trim.
Template hole size: 3/8", drill half way from both sides of door.

(B) FOR MORTISE CYLINDER

Drill only on the side of door that has a cylinder.
Template hole size: 1/4", drill only to mortise pocket.
Enlarge hole to 1-1/4" with a hole saw.

(C) FOR THUMB TURN MOUNTING PLATE

Drill only on side of door with thumb turn.
Template hole size: 1/16", drill to depth of 1/4".

(D) FOR THUMB TURN MOUNTING PLATE CLEARANCE HOLE

Drill only on side of door with thumb turn.
Template hole size: #20 drill, drill to depth of 1/8".

(E) FOR THUMB TURN

Drill only on side of door with thumb turn.
Template hole size: 1/14", drill only to mortise pocket.
Enlarge hole to 1/2".

(F) FOR LOCK INDICATOR

Drill only on side of door with indicator.
Template hole size: 1/4", drill to mortise pocket.
Enlarge hole to 3/4" with a hole saw.

(G) FOR THRU BOLT HOLES

Drill only on side of door with a knob or lever.
Template hole size: 1/4", drill to mortise pocket.

(H) FOR KNOB OR LEVER SPINDLE HOLE

Drill only on side of door with a knob or lever.
Template hole size: 1/4", drill to mortise pocket.
Enlarge hole to 3/4" with a hole saw.

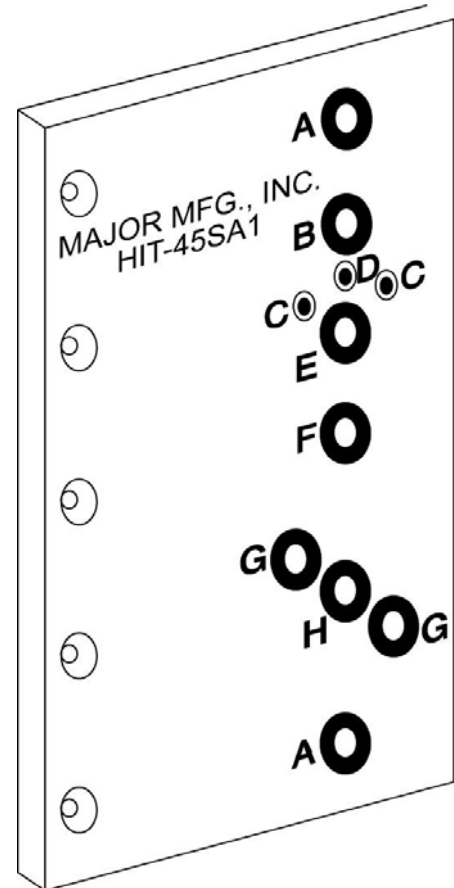

ALWAYS WEAR EYE AND EAR PROTECTION WHEN USING POWER TOOLS!

IMPORTANT: If using HIT-45 Clamp for faceplate routing you must remove bevel blocks prior to drilling function holes. Failure to do so will result in incorrect backset.

Major

MANUFACTURING, INC. (714) 772-5202 FAX (714) 772-2302

VIST OUR WEBSITE!

www.majormfg.com

SCHLAGE MORTISE LOCK HIT-45SL1 TEMPLATE GUIDE

FOR ML85 SERIES MORTISE LOCKS WITH ESCUTCHEON OR ROSETTER TRIM USED
IN CONJUNCTION WITH FACTORY PAPER TEMPLATE AND DIRECTIONS

USE MARKED HOLES AS FOLLOWS

(A) FOR ESCUTCHEON TRIM

Drill only for escutcheon trim.
Template hole size: 1/4", drill half way from both sides of door.
Enlarge hole to 5/8" with a hole saw.

(B) FOR MORTISE CYLINDER

Drill only on the side of door that has a cylinder.
Template hole size: 1/4", drill only to mortise pocket.
Enlarge hole to 1-1/4" with a hole saw.

(C) FOR THUMB TURN

Drill only on side of door with thumb turn.
Template hole size: 1/4", drill only to mortise pocket.
Enlarge hole to 5/8" with a hole saw.

(D) FOR THRU BOLT HOLES

Drill only on side of door with a Knob or Lever.
Template hole size: 3/8", drill to mortise pocket.

(E) FOR KNOB OR LEVER SPINDLE HOLE

Drill only on side of door with thumb turn.
Template hole size: 1/4", drill to mortise pocket.
Enlarge hole to 1" with a hole saw.

(F) FOR THUMB TURN MOUNTING HOLES

Drill only on side of door with thumb turn.
Template hole size: 1/16", drill to depth of 1/4".

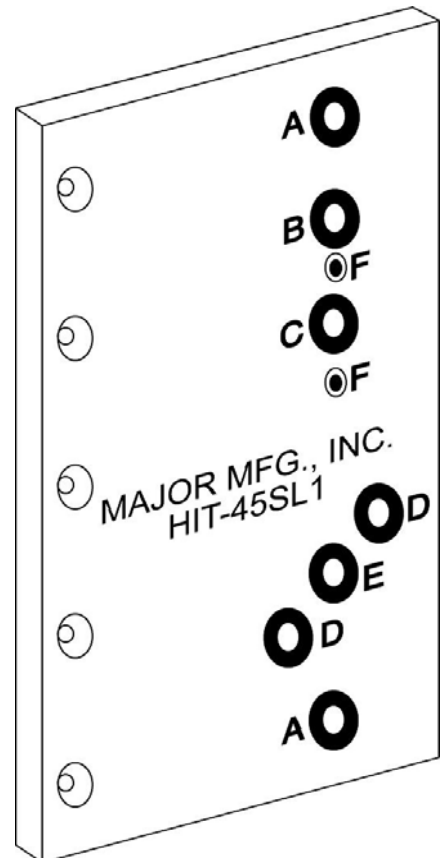

ALWAYS WEAR EYE AND EAR PROTECTION WHEN USING POWER TOOLS!

IMPORTANT: If using HIT-45 Clamp for faceplate routing you must remove bevel blocks prior to drilling function holes. Failure to do so will result in incorrect backset.

Major
MANUFACTURING, INC.

VISIT OUR WEBSITE!

www.majormfg.com

(714) 772-5202 FAX (714) 772-2302

UNICAN SOLITAIRE MORTISE LOCK HIT-45UN2 TEMPLATE GUIDE

FOR USE WITH 710/850/950 MORTISE LOCKS

USE MARKED HOLES AS FOLLOWS

(A) FOR THRU-BOLTED ESCUTCHEON TRIM

Drill only if using thru-bolted escutcheon trim.
Template hole size: 1/4", drill half way from both sides of door.
Enlarge hole to 7/16" after all holes are drilled and HIT-45 has been removed from door.

(B) FOR PASSAGE CABLE

Template hole size: 1/4", drill half way from both sides of door.
Enlarge hole to 1-1/4" with a hole saw after all holes are drilled and HIT-45 has been removed from door.

(C) FOR PRIVACY FUNCTION

Drill only on side of door that the turn piece or emergency turn piece is to be installed on.
Template hole size: 1/4", drill only to mortise pocket.
Enlarge hole to 7/8" with a hole saw after all holes are drilled and HIT-45 has been removed from door.

(D) FOR GUIDING POSTS FOR 710/850/950 ONLY

Drill holes only if using trim that requires mounting holes.
Not required on 710-11 to 715-11 series.
Template hole size: 1/4", drill to mortise pocket from both sides of door.

(E) LEVER HOLE

Drill to mortise pocket from both sides of door.
Template hole size: 1/4". Enlarge to 1-1/4" with a hole saw after all holes are drilled and HIT-45 has been removed from door.

(F) FOR MECHANICAL KEY CYLINDER OVERRIDE

Drill hole only when using mechanical key cylinder override on outside of door. Template hole size: 1/4". Enlarge to 1-3/8 x 1-1/4" deep with a hole saw after all holes are drilled and HIT-45 has been removed from the door.

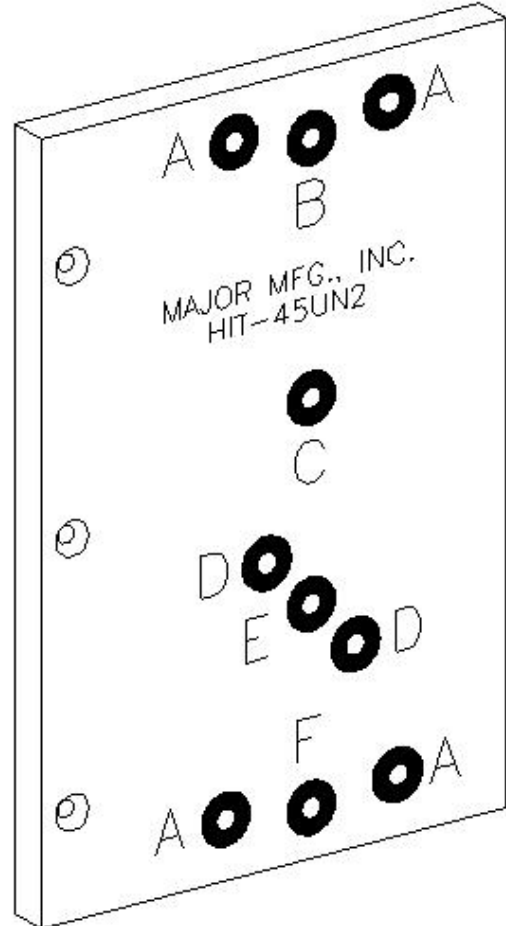

ALWAYS WEAR EYE AND EAR PROTECTION WHEN USING POWER TOOLS!

IMPORTANT: If using HIT-45 Clamp for faceplate routing you must remove bevel blocks prior to drilling function holes. Failure to do so will result in incorrect backset.

Major
MANUFACTURING, INC.

VISIT OUR WEBSITE!

www.majormfg.com

(714) 772-5202 FAX (714) 772-2302

HIT-45UN8 TEMPLATE GUIDE

FOR USE WITH UNICAN 8100 SERIES MORTISE LOCKS

USE MARKED HOLES AS FOLLOWS

(A) FOR UPPER LOCK MOUNTING SCREWS

Template hole size: 1/4", drill half way from both sides of door.

(B) FOR THUMB TURN FEATURE ACTUATOR

Template hole size: 1/4", drill to mortise pocket from both sides of door.

Enlarge hole to 1" with a hole saw after all template holes have been drilled and HIT-45 has been removed from door.

(C) FOR KEYWAY FEATURE ACTUATOR

Template hole size: 1/4", drill to mortise pocket from both sides of door,

Enlarge hole to 1" with a hole saw after all holes are drilled and HIT-45 has been removed from door.

TWO OPTIONS FOR DRILLING LEVER SPINDLE AND THRU-BOLT HOLES

OPTION #1 AS PER LOCK TEMPLATE

(D) LOCK SPINDLE AND THRU BOLT HOLES

Template hole size: 1/4", drill to mortise pocket from both sides of door.

Enlarge hole to 2-1/8" with a hole saw after all template holes have been drilled and HIT-45 has been removed from door. This hole will accept lock spindle and thru-bolts.

OPTION #2

(D) LOCK SPINDLE AND THRU BOLT HOLES

Template hole size: 1/4", drill to mortise pocket from both sides of door.

Enlarge hole to 2-1/8" **ON OUTSIDE OF DOOR ONLY** after all template holes have been drilled and HIT-45 has been removed from door.

Enlarge inside hole to 1" with a hole saw after all template holes have been drilled and HIT-45 has been removed from door. This hole will accept the lock spindle only.

(E) THRU-BOLT HOLES ON INSIDE OF DOOR

Template hole size: 5/16", drill to mortise pocket from inside of door.

After drilling all holes install lock per manufacturers directions and check for proper operation.

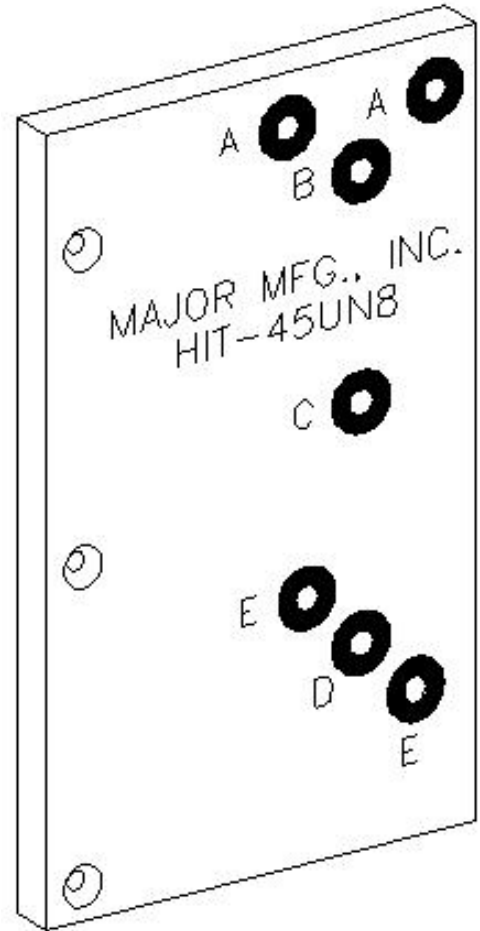

ALWAYS WEAR EYE AND EAR PROTECTION WHEN USING POWER TOOLS!

IMPORTANT: If using HIT-45 Clamp for faceplate routing you must remove bevel blocks prior to drilling function holes. Failure to do so will result in incorrect backset.

Major
MANUFACTURING, INC.

VISIT OUR WEBSITE!

(714) 772-5202 FAX (714) 772-2302

HIT-45YA2 TEMPLATE GUIDE

FOR USE WITH YALE 8800 SERIES MORTISE LOCKS

LETTERS ON HIT-45YA2 TEMPLATE FOLLOW LETTERS
ON PAPER YALE INSTALLATION TEMPLATE

USE MARKED HOLES AS FOLLOWS:

A. FOR KNOB OR LEVER SPINDLE HOLE.

Drill to mortise pocket from both sides of door. Template hole size: 1/4". Enlarge to 1-1/8" with a hole saw.

B. FOR MORTISE CYLINDER.

Drill only on the side of door that has a mortise cylinder. Template hole size 1/4", drill only to mortise pocket. Enlarge hole to 1-1/4" with a hole saw.

C. FOR THUMBTURN OR EMERGENCY KEY.

Drill only on side of door that the thumbturn or emergency key is to be installed on. Template hole size 1/4", drill only to mortise pocket. Enlarge hole to 3/4" with a hole saw.

D. HOTEL INDICATOR.

Drill only on side of door that the hotel indicator is to be installed on. Template hole size 1/4", drill only to mortise pocket. Enlarge hole to 3/4" with a hole saw.

E. THRU-BOLT HOLES FOR ROSE TRIM.

Drill holes only if using rose thru-bolted trim. Template hole size 5/16". Drill to mortise pocket from both sides of door.

F. THUMBTURN PLATE ATTACHING SCREWS.

Drill holes only if using sectional trim that requires a thumbturn plate. Template hole size 1/16" in wood door. If installing in metal door enlarge to #32 drill size after all holes are drilled and HIT-45 has been removed from door.

G. FOR THRU-BOLTED ESCUTCHEON TRIM.

Drill only if using thru-bolted escutcheon trim. Template hole size: 1/4". Enlarge to 1/2" after all holes are drilled and HIT-45 has been removed from door.

H. FOR SURFACE ESCUTCHEON TRIM.

Drill only if using surface mounted escutcheon trim. Template hole size 1/16" in wood door. If installing in metal door enlarge to #32 drill size after all holes are drilled and HIT-45 has been removed from door.

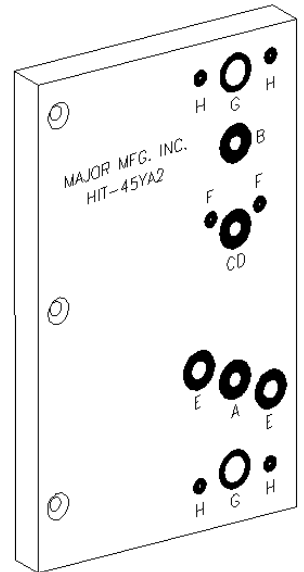

**ALWAYS WEAR
EYE AND EAR
PROTECTION
WHEN USING
POWER TOOLS.**

IMPORTANT: If using HIT-45 clamp for faceplate routing you must remove bevel blocks prior to drilling function holes. Failure to do so will result in incorrect backset.

Major
MANUFACTURING, INC.

1825 Via Burton, Anaheim, CA, 92806

714-772-5202 / Fax 714-772-2302 / Email / mail@majormfg.com / web www.majormfg.com

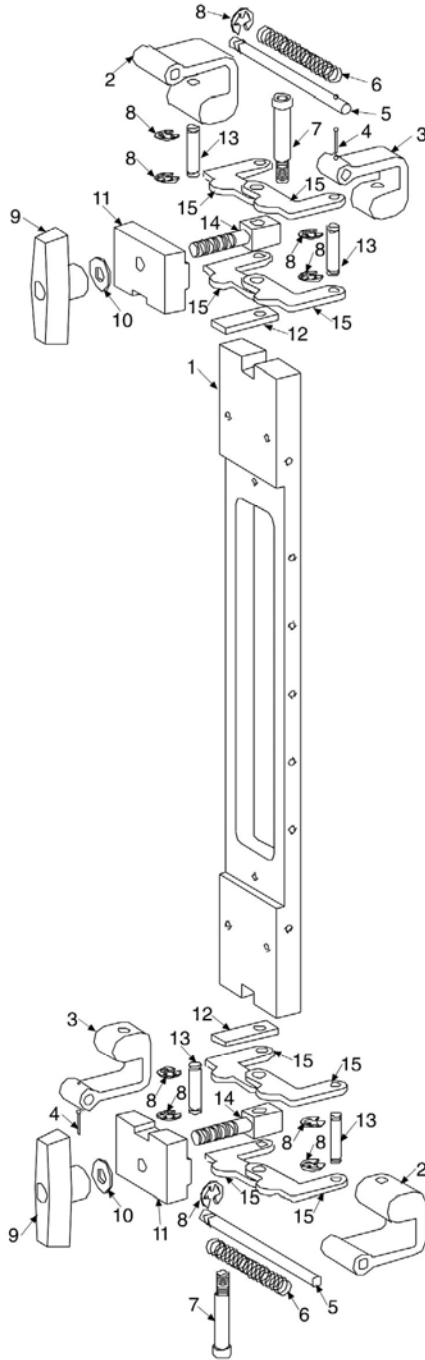

**TEMPLATE
MOUNTING SCREWS**

 25 4535 Flat Head Screw, 1/2" l

 26 4536 Flat Head Screw, 3/4" l

ITEM	PART NO.	DESCRIPTION	ITEM	PART NO.	DESCRIPTION	ITEM	PART NO.	DESCRIPTION
1	4501	Base	10	4515	Bearing Washer	24	4508	Button Head Screw
2	4528	R.H. Foot Bracket	11	4507	Block	25	4535	Flat Head Screw, 1/2" long
3	4529	L.H. Foot Bracket	12	4523	Support Locator	26	4536	Flat Head Screw, 3/4" long
4	4531	Roll Pin	13	4505	Clamp Pin			
5	4530	Shaft	14	4514	Stud Locator			
6	4532	Compression Spring	15	4506	Clamp			
7	4533	Shoulder Bolt	20	4511	Alignment Plate SC			
8	4504	E-Ring	22	4509	Locator SC			
9	4534	Knob	23	4526	Locator Stud			



MANUFACTURING, INC. (714) 772-5202 FAX (714) 772-2302

