

Heavy-Duty Latchbolt 112

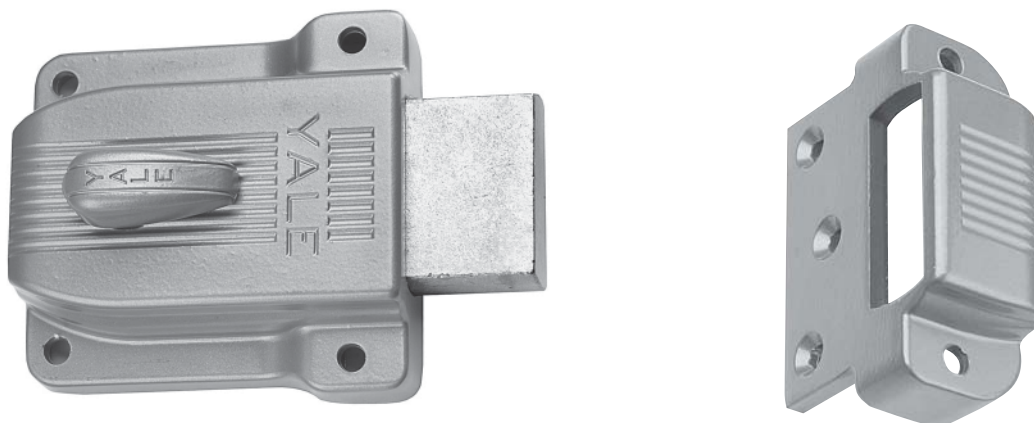

Operation

Outside: Furnished standard with 5-pin rim cylinder 1109E.

Inside: 180° turn of the thumbturn throws or retracts deadbolt. Also available with flat strike, model no. 112F (for outswinging doors).

Model Numbers	
112	Boxed
112F	Flat Strike, Boxed

Dimensions And Details

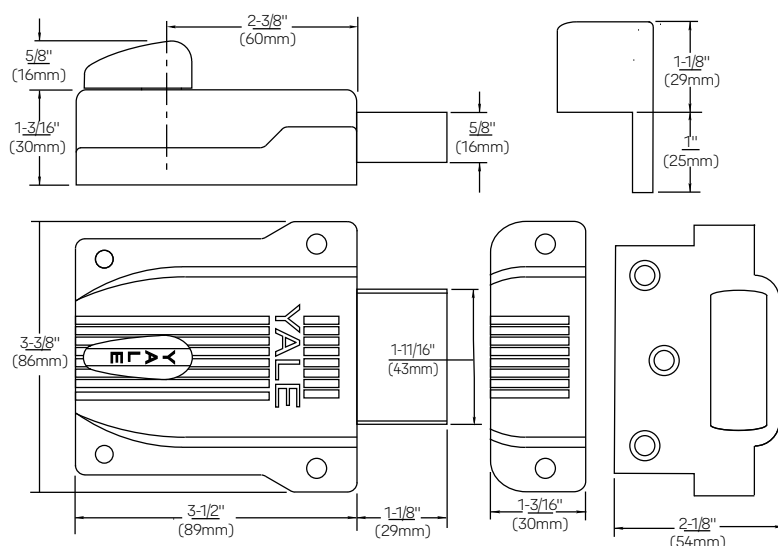

Technical Information

Description	112
Backset	2-3/8" (60mm)
Material	Zinc Alloy
Springbolt Length	1-1/8" (29mm)
Cylinder	1109E Brass 5-pin with anti-pick mushroom drivers
Case Finishes	Sprayed Brass only
Cylinder Finish	Brass
2 Keys	RB8
Door Thickness	1-3/8" to 2-1/4" (35mm-57mm)

Dimensions are shown in inches (millimeters).