

VON DUPRIN®

98/99  
Series

Exit devices



<b>How to order</b>	<b>4</b>
<b>Device types</b>	<b>5</b>
<b>Trim options</b>	<b>30</b>
<b>Mechanical options</b>	<b>42</b>
Dogging options	42
Classroom security/security indicators	43
Environmental options	44
Weatherized options	45
Accessibility options	46
Latches	46
Push pads	47
<b>Electrified options</b>	<b>48</b>
Latch retraction	48
Delayed egress	50
Switches	55
Alarm kit	56
Electrified mortise and electrified trim	57
Power supplies	58
Electrical and pneumatic power transfers	59
Allegion Connect	60
<b>Accessories</b>	<b>61</b>
Strikes	61
Door kits	63
Sex bolts	64
Mullions	65
Steel and aluminum mullions	66
<b>Additional information</b>	<b>67</b>
UL Listing for fire exit hardware	67
Function, grade and type options	68
Stile information	69
Lever styles and finishes	70
Device finish options	71

### Information and customer care



[us.allegion.com](http://us.allegion.com)



US 877.671.7011  
Canada 800.900.4734



[support@allegion.com](mailto:support@allegion.com)  
[Exits\\_TechProdSupport@allegion.com](mailto:Exits_TechProdSupport@allegion.com)



[www.youtube.com/VonDuprinSafety/](http://www.youtube.com/VonDuprinSafety/)

### Ordering



[allegion\\_orders@allegion.com](mailto:allegion_orders@allegion.com)



eFax: 1.800.999.0328

## Engineered for value and performance

Von Duprin® empowers its customers to embrace change by providing flexible solutions that can be modified over time, protecting your investment well into the future. Von Duprin 98/99 Series push pad devices have a universal center case design that is unique to the industry and provides superior flexibility—from adding trim, switching handing or adding new retrofit options, you can configure numerous variations in the field without replacing your device.

Von Duprin's exit devices offer durable solutions that are proven in the field to perform under heavy use and abuse and backed by a team of experts experienced in door hardware application and code compliance. Allegion stands behind every Von Duprin product we make with unparalleled customer support thanks to our team of experts based in the U.S. that average more than 15 years of experience, so you are assured to receive expert advice.

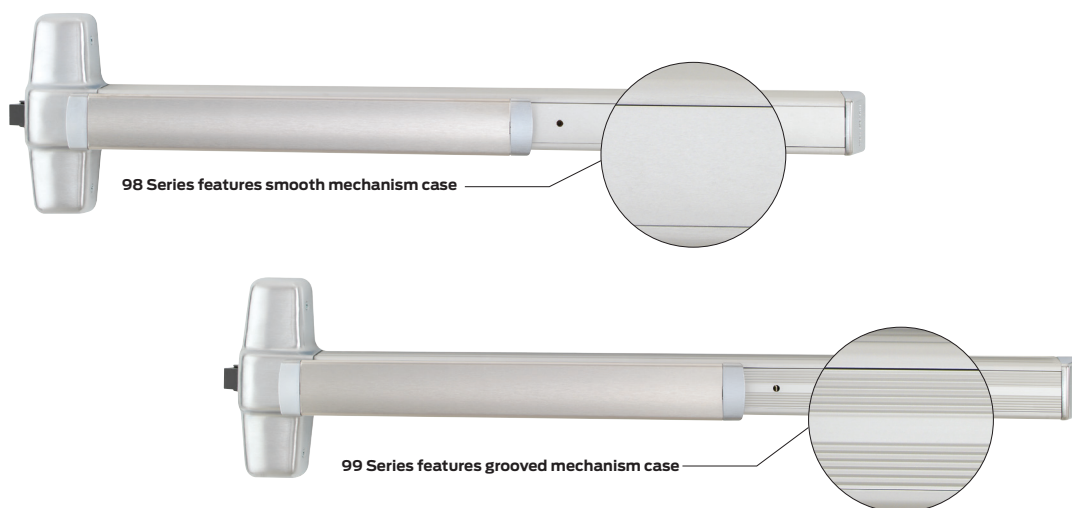

Von Duprin exit devices are available in two external surface styles, designated 98 and 99 Series.

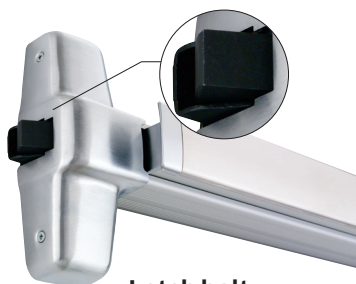

### Latch bolt

Deadlocking latch bolt provides security and improved performance at standard device cost.

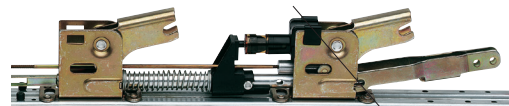

### The Quiet One®

A fluid damper decelerates the push pad on its return stroke and eliminates most noise associated with exit device operations. Furnished on all 98/99™ Series exit devices.

# Nomenclature – how to order

Prefix	Device series/type		Trim/rating		Suffix/finish		Door width	Handing	Less bottom rod/cable	Trim options/finish	Lever style	Accessories	Other information
1	2	3	4	5	6	7	8	9	10	11	12	13	14
QEL	- 98	- 27	- L	- F	-	- 626	- 3'	- RHR	- LBR	- 996/626	- 299F/06	- SNB	- HM

## Detail

### 1 Prefixes

<b>None</b>	Standard
<b>AX</b>	Accessible device
<b>CD</b>	Cylinder dogging - panic only
<b>CDSI</b>	Cylinder dogging with security indicator
<b>CI</b>	Cylinder dogging indicator
<b>CD-CX</b>	Chexit cylinder dogging
<b>CX</b>	Chexit
<b>DI</b>	Dogging indicator
<b>E</b>	Electric locking mortise/lever
<b>EL</b>	Electric latch retraction
<b>HDSI</b>	Hex dogging with security indicator
<b>HH</b>	Hurrican device
<b>LD</b>	Less dogging
<b>LX</b>	Latch bolt monitoring
<b>LX-LC</b>	Latch bolt monitoring, low current
<b>LX-RX</b>	Latch bolt monitoring, request to exit
<b>LX-RX-LC</b>	Latch bolt monitoring, request to exit low current
<b>PL</b>	Pullman latch
<b>PN</b>	Pneumatic latch retraction
<b>QEL</b>	Quiet electric latch retraction
<b>QM</b>	Quiet mechanical
<b>RX</b>	Request to exit
<b>RX2</b>	Double request to exit
<b>RX-AUX</b>	Request to exit, auxiliary
<b>RX-LC</b>	Request to exit, low current
<b>SD</b>	Special dogging -panic only
<b>SS</b>	Signal switch
<b>WP-RX</b>	Waterproof request to exit
<b>WS</b>	Windstorm (FEMA rated) surface vertical rod device
<b>XP</b>	Heavy protection - rim

### 2 Device series

<b>98</b>	Series 98-smooth
<b>99</b>	Series 99-grooved

### 3 Device type

<b>None</b>	Rim device
<b>27</b>	Surface mounted vertical rod device
<b>47</b>	Concealed vertical rod device
<b>47WDC</b>	Concealed vertical rod wood door device
<b>48</b>	Concealed vertical rod device
<b>49</b>	Concealed vertical cable device
<b>50WDC</b>	Concealed vertical cable wood door device
<b>52</b>	Rim device with remote trim input (pool exit hardware)
<b>57</b>	Three-point latch device
<b>75</b>	Mortise lock device

### 4 Trim functions

<b>EO</b>	For AD or CO locks, order the panic as Exit Only (EO)
<b>DT</b>	Dummy trim
<b>EO</b>	Exit only
<b>HL</b>	Hospital pull trim
<b>K</b>	Knob
<b>K-BE</b>	Knob - blank escutcheon
<b>K-DT</b>	Knob, rigid - dummy trim
<b>K-NL</b>	Knob, rigid - night latch
<b>L</b>	Lever (classroom)
<b>L-BE</b>	Lever - blank escutcheon
<b>L-DT</b>	Lever, rigid - dummy trim
<b>L-NL</b>	Lever, rigid - night latch
<b>NL</b>	Night latch
<b>NL-OP</b>	Night latch cylinder assembly, optional pull
<b>TL</b>	Turn lever
<b>TL-BE</b>	Turn lever - blank escutcheon
<b>TP</b>	Thumbpiece
<b>TP-BE</b>	Thumbpiece - blank escutcheon

### 5 Rating

<b>F</b>	Fire exit hardware
<b>Blank</b>	Panic exit hardware

### 6 Suffix

<b>-2</b>	Double cylinder (rim and mortise only)
<b>-2SI</b>	Double cylinder with security indicator (rim only)
<b>CON</b>	Connectors
<b>WH</b>	Weep holes

### 7 Finish

<b>605</b>	Bright Brass
<b>606</b>	Satin Brass
<b>612</b>	Satin Bronze
<b>619</b>	Satin Nickel
<b>622/711</b>	Matte Black/Matte Black, Anodized
<b>625</b>	Bright Chrome
<b>626</b>	Satin Chrome
<b>626AM</b>	Satin Chrome, Antimicrobial
<b>628</b>	Aluminum, Anodized
<b>630</b>	Satin Stainless
<b>630AM</b>	Satin Stainless, Antimicrobial
<b>643e</b>	Aged Bronze
<b>693</b>	Black Paint
<b>710</b>	Dark Brown, Anodized

### 8 Door width

<b>3'</b>	Standard default	1 3/4"	Standard
<b>4'</b>		2 1/4"	Optional
<b>2'</b>	Vertical only		

### Door thickness

### 9 Handing

<b>LHR</b>	Left hand reverse
<b>RHR</b>	Right hand reverse

### 10 Less bottom rod/cable

<b>LBR</b>	Less bottom rod
<b>LBL</b>	Less bottom latch
<b>LBR-AFL</b>	LBR with fire pin
<b>LBL-AFL</b>	LBL with fire pin

### 11 Trim options/finish

See trim options/finish for each device type

### 12 Lever style

<b>06</b>	Standard default (optional levers available)
-----------	--

### 13 Accessories

<b>CYL</b>	Cylinder
<b>GBK</b>	Glass bead kit
<b>SEC</b>	Security screws
<b>SLM</b>	SLM blocking
<b>SNB</b>	Sex bolts

### 14 Other information

#### Touchbar options

<b>BRaille</b>	Vision impaired touchpad, raised letter, and braille
<b>PUSH</b>	Touchbar trim embossed 'PUSH'
<b>RSS</b>	Red silk-screened lettered touchbar trim
<b>KN</b>	Knurled touchbar
<b>SG</b>	Safety glow

#### Miscellaneous

<b>CE</b>	CE labeled
<b>LCP</b>	Less cover plate
<b>IOWDA</b>	#IOWDA cover plate
<b>RAT REL</b>	Ratchet release assy

#### Door material

<b>AL</b>	Aluminum door
<b>HM</b>	Hollow metal
<b>WD</b>	Wood door
<b>CP</b>	Composite door
<b>INS2</b>	Insulclad - 1/2"
<b>INS4</b>	Insulclad - 1/4"
<b>SC</b>	Steelcraft, HH device only

#### Door application

<b>D</b>	Double egress
<b>P</b>	Pair of doors
<b>S</b>	Single door

Note: Not all options are listed. See the specific device type pages for complete options available.

## Device types

As the pioneer in the industry, Von Duprin continues to advance the industry through customer-centric innovation, which delivers solutions to the most challenging applications.

Backed by high quality standards, Von Duprin exit devices were among the first in the industry certified to ANSI/BHMA A156.3 (2014) Grade 1. Our exit devices are tested to the highest standards and proven in the field to perform under heavy use and abuse, giving you peace of mind both now and in the future.

The versatile design can be easily upgraded to connect to a larger electronic ecosystem, empowering you to adapt with flexible solutions. You can configure numerous variations in the field without replacing your device and protecting your investment. This makes upgrades easy and cost effective.

## Popular applications

### Single door applications

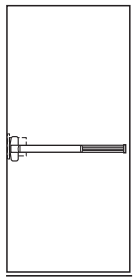

Single mortise lock device

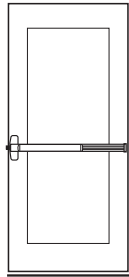

Single rim device

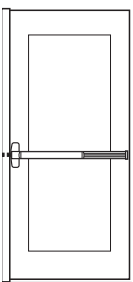

Single three-point latch device

### Double door applications

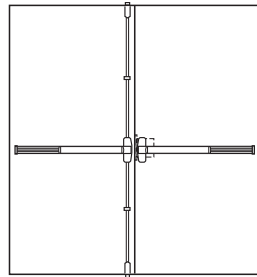

Mortise lock and surface mounted or concealed vertical cable/rod device combination—same direction

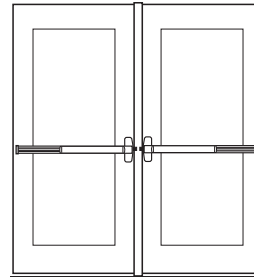

Two rim devices with mullion—same direction

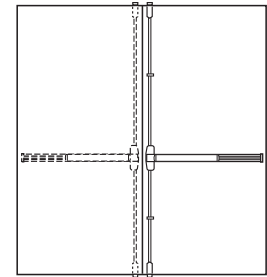

Two vertical rods—double egress  
Two surface/concealed rods or cables

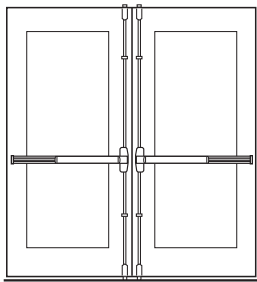

Two surface mounted vertical rod devices—same direction\*

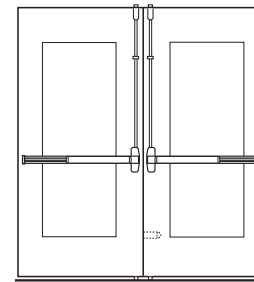

Two fire exit hardware vertical cables/rods with auxiliary fire latch-LBR option\*

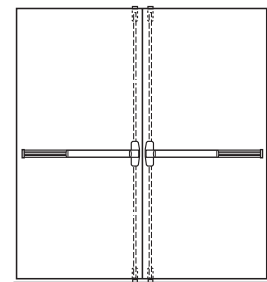

Two concealed vertical cables/rods\*

\* Do not use with overlapping astragals

## Door handing

Left hand-reverse orientation

Right hand-reverse orientation

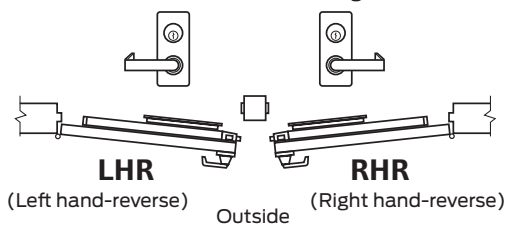

# 98/99 Rim exit device



98 and 99 rim exit devices for all types of single and double doors with mullion, UL listed for panic exit hardware. Devices are certified to ANSI/BHMA A156.3 2014, Grade 1. The 98 device has a smooth mechanism case and the 99 device has a grooved case. The rim device is non-handed except when the following device options are used: SD (special dogging), -2 (double cylinder) or SS (signal switch). Covers stock hollow metal doors with 86 or 161 cutouts on single doors (may cover cutouts on pairs – consult template).

### Specifications

Device functions	Device ships EO/DT/NL; Field selectable; For TP, K or L remove NL drive screw from device	
Device lengths	3' 2'4" to 3' (711mm to 914mm)	Door size
	4' 2'10" to 4' (864mm to 1219mm)	Door size
Device centerline from finished floor	39 <sup>13</sup> / <sub>16</sub> " (1011mm)	
	39 <sup>11</sup> / <sub>16</sub> " (1008mm) with mullion	
Center case	8" x 2 <sup>3</sup> / <sub>4</sub> " x 2 <sup>3</sup> / <sub>8</sub> " (203mm x 70mm x 60mm)	
Mechanism case	2 <sup>1</sup> / <sub>4</sub> " x 2 <sup>1</sup> / <sub>4</sub> " (57mm x 57mm)	
Projection	Pushbar neutral – 3 13/16" (97mm) Pushbar depressed – 3 1/16" (78mm)	
Latch bolt	Deadlocking, 3/4" (19mm) throw	
Finishes	605, 606, 612, 625, 626/626AM, 628, 710, 711 and 643e (619 and 630 available with 98 Series only)	
Fasteners and sex bolts (SNB)	Includes screw pack for 1 <sup>3</sup> / <sub>4</sub> " (44mm) and 2 <sup>1</sup> / <sub>4</sub> " (57mm) thick metal or wood doors (Optional 425 SNB available, see page 64 for quantities)	

### Features and options

#### Electrified options

- LX** Latch bolt monitor switch
- RX** Request to exit
- RX2** Double request to exit
- E** Electric locking and unlocking trim
- EL** Electric latch retraction
- QEL** Quiet electric latch retraction
- SS** Signal switch
- CX** Chexit delayed exit
- ALK** Alarm exit kit
- WP-RX** Waterproof request to exit
- CON** Allegion Connect

#### Mechanical options

- 2** Double cylinder
- 2SI** Double cylinder with security indicator
- AX** Accessible device
- GBK** Glass bead kit
- PN** Pneumatic latch retraction
- QM** Quiet mechanical
- SNB** Sex bolts
- SEC** Security screws
- WH** Weep holes
- XP** Extra protection

#### Dogging feature

Hex key dogging standard

#### Dogging options

- CD** Cylinder dogging
- CD-CX** Chexit cylinder dogging
- CDSI** Cylinder dogging with security indicator
- HDSI** Hex dogging with security indicator
- SD** Special center case dogging
- LD** Less dogging
- DI** Dogging indicator
- CI** Cylinder dogging indicator

#### Strikes

**299** – Dull black

### Accessories



#### 299 Strike

Ships standard, optional strikes available.



#### Hex key dogging

Comes standard on 98/99 rim exit devices.

## Device types

### 98-F/99-F Rim exit device



98-F and 99-F Rim fire exit devices are certified to ANSI/BHMA A156.3 2014, Grade 1 and UL listed for fire exit hardware. See page 67 for detailed information on UL fire exit hardware label and door opening size information. The 98-F device has a smooth mechanism case and the 99-F device has a grooved case. The rim device is non-handed except when the following device options are used: -2 (double cylinder) or SS (signal switch).

#### Specifications

Device functions	Device ships EO/DT/N; Field selectable; For TP, K or L remove NL drive screw from device
Device lengths	3' 2'4" to 3' (711mm to 914mm) Door size 4' 2'10" to 4' (864mm to 1219mm) Door size
Device centerline from finished floor	39 <sup>13</sup> / <sub>16</sub> " (1011mm) 39 <sup>11</sup> / <sub>16</sub> " (1008mm) with mullion
Center case	8" x 2 <sup>3</sup> / <sub>4</sub> " x 2 <sup>3</sup> / <sub>8</sub> " (203mm x 70mm x 60mm)
Mechanism case	2 <sup>1</sup> / <sub>4</sub> " x 2 <sup>1</sup> / <sub>4</sub> " (57mm x 57mm)
Projection	Pushbar neutral – 3 <sup>13</sup> / <sub>16</sub> " (97mm) Pushbar depressed – 3 <sup>1</sup> / <sub>16</sub> " (78mm)
Latch bolt	Deadlocking, <sup>3</sup> / <sub>4</sub> " (19mm) throw
Finishes	605, 606, 612, 626/626AM, 628, 710, 711 and 643e (619 and 630 available with 98 Series only)
Fasteners and sex bolts (SNB)	Includes screw pack for 1 <sup>3</sup> / <sub>4</sub> " (44mm) and 2 <sup>1</sup> / <sub>4</sub> " (57mm) thick metal or wood doors; Optional 425 SNB available for metal doors; 425 and 825 SNB required on wood doors without SLM blocking (See page 64 for quantities)

#### Accessories



##### 299F Strike

Ships standard, optional strikes available



##### 499F Strike

With 9854/9954 mullion

#### Features and options

##### Electrified options

<b>LX</b>	Latch bolt monitor switch
<b>RX</b>	Request to exit
<b>RX2</b>	Double request to exit
<b>E</b>	Electric locking and unlocking trim
<b>EL</b>	Electric latch retraction
<b>QEL</b>	Quiet electric latch retraction
<b>SS</b>	Signal switch
<b>CX</b>	Chexit delayed exit
<b>ALK</b>	Alarm exit kit
<b>WP-RX</b>	Waterproof request to exit
<b>CON</b>	Alliegion Connect

##### Mechanical options

<b>-2</b>	Double cylinder
<b>-2SI</b>	Double cylinder with security indicator
<b>AX</b>	Accessible device
<b>GBK</b>	Glass bead kit
<b>PN</b>	Pneumatic latch retraction
<b>QM</b>	Quiet mechanical
<b>SNB</b>	Sex bolts
<b>SEC</b>	Security screws
<b>SLM</b>	Special laminate material blocking
<b>WH</b>	Weep holes
<b>XP</b>	Extra protection

##### Dogging option

No mechanical dogging;  
EL and QEL options available

##### Strikes

**299F** – Dull black, 499F with mullions

## XP98/99 Rim exit device



XP98/99 Rim exit devices are designed for single and double doors with mullion that require increased security. The “smart” latch changes shape when subjected to external forces. This design enables the exit door to withstand an external attack and remain secure. Additionally, the patented latch bolt design provides greater, longer-lasting latch bolt to strike contact which is not easily affected by the twisting motion of a weakened frame, resulting in an opening that will remain strong. Devices are certified to ANSI/BHMA A156.3 2014, Grade 1 and UL listed for panic exit hardware. The rim device is non-handed except when the following device options are used: SD (special dogging) or -2 (double cylinder). Covers stock hollow metal doors with 86 or 161 cutouts on single doors (may cover cutouts on pairs – consult template).

### Specifications

Device functions	Device ships EO/DT/NL; Field selectable; For TP, K or L remove NL drive screw from device
Device lengths	3' 2'4" to 3' (711mm to 914mm) door size 4' 2'10" to 4' (864mm to 1219mm) door size
Device centerline from finished floor	39 13/16" (1011mm) 39 11/16" (1008mm) with mullion
Center case	8" x 2 3/4" x 2 3/8" (203mm x 70mm x 60mm)
Mechanism case	2 1/4" x 2 1/4" (57mm x 57mm)
Projection	Pushbar neutral – 3 13/16" (97mm) Pushbar depressed – 3 1/16" (78mm)
Latch bolt	Deadlocking, 3/4" (19mm) throw
Finishes	605, 606, 612, 625, 626/626AM, 628, 710, 711 and 643e (619 and 630 available with 98 Series only)
Fasteners and sex bolts (SNB)	Includes screw pack for 1 3/4" (44mm) and 2 1/4" (57mm) thick metal or wood doors (Optional 425 SNB available, see page 64 for quantities)

### Features and options

#### Electrified options

<b>LX-LC</b>	Latch bolt monitor switch, low current
<b>RX</b>	Request to exit
<b>RX2</b>	Double request to exit
<b>E</b>	Electric locking and unlocking trim
<b>EL</b>	Electric latch retraction
<b>QEL</b>	Quiet electric latch retraction
<b>CX</b>	Chexit delayed exit
<b>ALK</b>	Alarm exit kit
<b>WP-RX</b>	Waterproof request to exit
<b>CON</b>	Alliegion Connect

#### Mechanical options

<b>-2</b>	Double cylinder
<b>-2SI</b>	Double cylinder with security indicator
<b>AX</b>	Accessible device
<b>GBK</b>	Glass bead kit
<b>SNB</b>	Sex bolts
<b>SEC</b>	Security screws
<b>WH</b>	Weep holes

#### Dogging feature

Hex key dogging standard

#### Dogging options

<b>CD</b>	Cylinder dogging
<b>CD-CX</b>	Chexit cylinder dogging
<b>CDSI</b>	Cylinder dogging with security indicator
<b>HDSI</b>	Hex dogging with security indicator
<b>SD</b>	Special center case dogging
<b>LD</b>	Less dogging
<b>DI</b>	Dogging indicator
<b>CI</b>	Cylinder dogging indicator

#### Strikes

909 – Dull black

### Accessories



#### 909 Strike

Ships standard for single or double doors.



#### XP latch

Provides increased security with its two piece design.



#### Hex key dogging

Comes standard on 98/99 rim exit devices.



## Device types

### XP98-F/99-F Rim exit device



XP98/99 Rim fire exit devices are certified to ANSI/BHMA A156.3 2014, Grade 1 and UL listed for fire exit hardware. See page 67 for detailed information on UL fire exit hardware label and door opening size information. These are designed for single and double doors with 9954-XP mullion that require increased security. The “smart” latch changes shape when subjected to external forces. This design enables the exit door to withstand an external attack and remain secure. Additionally, the patented latch bolt design provides greater, longer-lasting latch bolt to strike contact which is not easily affected by the twisting motion of a weakened frame, resulting in an opening that will remain strong. The rim device is non-handed except when the following device option is used: -2 (double cylinder). Covers stock hollow metal doors with 86 or 161 cutouts on single doors (may cover cutouts on pairs – consult template).

#### Specifications

Device functions	Device ships EO/DT/NL; Field selectable; For TP, K or L remove NL drive screw from device
Device lengths	3' 2'¼" to 3' (711mm to 914mm) Door size 4' 2'10" to 4' (864mm to 1219mm) Door size
Device centerline from finished floor	39 13/16" (1011mm) 39 11/16" (1008mm) with mullion
Center case	8" x 2 3/4" x 2 3/8" (203mm x 70mm x 60mm)
Mechanism case	2 1/4" x 2 1/4" (57mm x 57mm)
Projection	Pushbar neutral – 3 13/16" (97 mm) Pushbar depressed – 3 1/16" (78 mm)
Latch bolt	Deadlocking, 3/4" (19mm) throw
Finishes	605, 606, 612, 625, 626/626AM, 628, 710, 711 and 643e (619 and 630 available with 98 Series only)
Fasteners and sex bolts (SNB)	Includes screw pack for 1 3/4" (44mm) and 2 1/4" (57mm) thick metal or wood doors. Optional 425 SNB available for metal doors. 425 and 825 SNB required on wood doors without SLM blocking (See page 64 for quantities)

#### Accessories



**909 Strike**  
Ships standard for single doors.



**XP latch**  
Provides increased security with its two piece design.



**954 Strike**  
For fire rated double doors and 9954XP mullion.

#### Features and options

##### Electrified options

<b>LX-LC</b>	Latch bolt monitor switch, low current
<b>RX</b>	Request to exit
<b>RX2</b>	Double request to exit
<b>E</b>	Electric locking and unlocking trim
<b>EL</b>	Electric latch retraction
<b>QEL</b>	Quiet electric latch retraction
<b>CX</b>	Chexit delayed exit
<b>ALK</b>	Alarm exit kit
<b>WP-RX</b>	Waterproof request to exit
<b>CON</b>	Alligion Connect

##### Mechanical options

<b>-2</b>	Double cylinder
<b>-2SI</b>	Double cylinder with security indicator
<b>AX</b>	Accessible device
<b>GBK</b>	Glass bead kit
<b>SNB</b>	Sex bolts
<b>SEC</b>	Security screws
<b>SLM</b>	Special laminate material blocking
<b>WH</b>	Weep holes

##### Dogging option

No mechanical dogging;  
EL and QEL options available

##### Strikes

**909** – Dull black, fire rated single doors  
**954** – Dull black, fire rated double doors

# 9875/9975 Mortise lock device



9875/9975 Mortise lock device for all types of single or double doors, UL listed for panic exit hardware. Devices are certified to ANSI/BHMA A156.3 2014, Grade 1. Fits stock hollow metal doors with 86 cutout and door stiles as narrow as 4 3/4" (121mm). The 9875 device has a smooth mechanism case and the 9975 device has a grooved case. The mortise lock device is non-handed except when the following device options are used: -2 (double cylinder) or SS (signal switch).

The 7500 Mortise lock is equipped with a 3/4" (19mm) anti-friction latch bolt which is field reversible without removing the lock from the door. It has a non-handed auxiliary bolt for deadlocking and a faceplate with an adjustable bevel.

### Specifications

Device functions	Device ships EO/DT/NL; Field selectable; For TP, K or L remove NL drive screw from device
Device lengths	3' 2'4" to 3' (711mm to 914mm) Door size 4' 2'10" to 4' (864mm to 1219mm) Door size
Device centerline from finished floor	39 13/16" (1011mm) 39 11/16" (1008mm) with mullion
Center case	8" x 2 3/4" x 2 3/8" (203mm x 70mm x 60mm)
Mechanism case	2 1/4" x 2 1/4" (57mm x 57mm)
Projection	Pushbar neutral – 3 13/16" (97mm) Pushbar depressed – 3 1/16" (78mm)
Finishes	605, 606, 612, 625, 626/626AM, 628, 710, 711 and 643e (619 and 630 available with 98 Series only)
Fasteners and sex bolts (SNB)	Includes screw pack for 1 3/4" (44mm) and 2 1/4" (57mm) thick metal or wood doors. (Optional 425 SNB available, see page 64 for quantities)

### Features and options

#### Electrified options

- RX** Request to exit
- RX2** Double request to exit
- E** Electric locking and unlocking trim/mortise lock
- EL** Electric latch retraction
- QEL** Quiet electric latch retraction
- SS** Signal switch
- CX** Chexit delayed exit
- ALK** Alarm exit kit
- WP-RX** Waterproof request to exit
- CON** Allegion Connect

#### Mechanical options

- 2** Double cylinder
- GBK** Glass bead kit
- PN** Pneumatic latch retraction
- SNB** Sex bolts
- SEC** Security screws
- WH** Weep holes

#### Dogging feature

Hex key dogging standard

#### Dogging options

- CD** Cylinder dogging
- CD-CX** Chexit cylinder dogging
- CDSI** Cylinder dogging with security indicator
- HDSI** Hex dogging with security indicator
- SD** Special center case dogging
- LD** Less dogging
- DI** Dogging indicator
- CI** Cylinder dogging indicator

#### Strikes

- 575** – Dull black

### Accessories

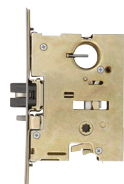

**7500 Mortise lock**



**575 Strike**



**Hex key dogging**  
Comes standard on 9875/9975 mortise lock exit devices.

## Device types

### 9875-F/9975-F Mortise lock fire exit device



9875-F/9975-F Fire exit mortise lock devices are certified to ANSI/BHMA A156.3 2014, Grade 1 and UL listed for fire exit hardware. See page 67 for detailed information on UL listed fire exit hardware label and door opening size information. Fits door stiles as narrow as 4 3/4" (121mm). The 9875-F device has a smooth mechanism case and the 9975-F device has a grooved case. The mortise lock device is non-handed except when the following device options are used: -2 (double cylinder) or SS (signal switch) devices.

The 7500 Mortise lock is equipped with 3/4" (19mm) anti-friction latch bolt which is field reversible without removing the lock from the door. It has a non-handed auxiliary bolt for deadlocking and a faceplate with an adjustable bevel.

#### Specifications

Device functions	Device ships EO/DT/NL; Field selectable; For TP, K or L remove NL drive screw
Device lengths	3' 2 1/4' to 3' (711mm to 914mm) Door size 4' 2'10" to 4' (864mm to 1219mm) Door size
Device centerline from finished floor	39 13/16" (1011mm) 39 11/16" (1008mm) with mullion
Center case	8" x 2 3/4" x 2 3/8" (203mm x 70mm x 60mm)
Mechanism case	2 1/4" x 2 1/4" (57mm x 57mm)
Projection	Pushbar neutral – 3 13/16" (97mm) Pushbar depressed – 3 1/16" (78mm)
Finishes	605, 606, 612, 625, 626/626AM, 628, 710, 711 and 643e (619 and 630 available with 98 Series only)
Fasteners and sex bolts (SNB)	Includes screw pack for 1 3/4" (44mm) and 2 1/4" (57mm) thick metal or wood doors. Optional 425 SNB available for metal doors. 425 and 825 SNB required on wood doors without SLM blocking. (See page 64 for quantities)

#### Accessories

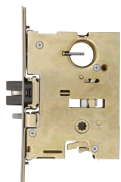

**7500  
Mortise lock**



**575 Strike**

#### Features and options

##### Electrified options

<b>RX</b>	Request to exit
<b>RX2</b>	Double request to exit
<b>E</b>	Electric locking and unlocking trim/mortise lock
<b>EL</b>	Electric latch retraction
<b>QEL</b>	Quiet electric latch retraction
<b>SS</b>	Signal switch
<b>CX</b>	Chexit delayed exit
<b>ALK</b>	Alarm exit kit
<b>WP-RX</b>	Waterproof request to exit
<b>CON</b>	Alligion Connect

##### Mechanical options

<b>-2</b>	Double cylinder
<b>GBK</b>	Glass bead kit
<b>PN</b>	Pneumatic latch retraction
<b>SNB</b>	Sex bolts
<b>SEC</b>	Security screws
<b>SLM</b>	Special laminate material blocking
<b>WH</b>	Weep holes

##### Dogging option

No mechanical dogging;  
EL and QEL options available

##### Strikes

**575** – Dull black

# 9827/9927 Surface mounted vertical rod device

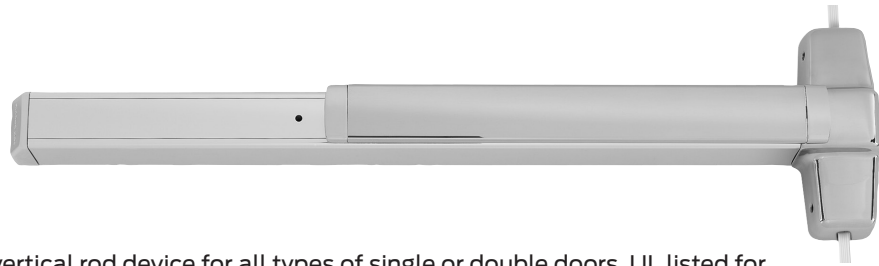

9827/9927 Surface mounted vertical rod device for all types of single or double doors, UL listed for panic exit hardware. Devices are certified to ANSI/BHMA A156.3 2014, Grade 1. Covers stock hollow metal doors with 86 or 161 cutouts. The 9827 device has a smooth mechanism case and the 9927 device has a grooved case. The surface vertical rod device is non-handed except when the following device options are used: SD (special dogging), SS (signal switch) or WS (tornado/hurricane). Vertical rod and latch guards are available to protect the bottom rod of the exit device from damage by impacts of carts or gurneys passing through doors.

### Specifications

Device functions	Device ships EO/DT/NL; Field selectable; For TP, K or L remove NL drive screw from device
Device lengths	2' 2' (610 mm) Door size 3' 2'4" to 3' (711mm to 914mm) Door size 4' 2'10" to 4' (864mm to 1219mm) Door size
Device centerline from finished floor	39 5/8" (1006 mm)
Center case	8" x 2 3/4" x 2 3/8" (203mm x 70mm x 60mm)
Mechanism case	2 1/4" x 2 1/4" (57mm x 57mm)
Projection	Pushbar neutral – 3 13/16" (97mm) Pushbar depressed – 3 1/16" (78mm)
Latch bolt	Deadlocking anti-friction top and bottom bolt, 5/8" (16mm) throw
Door undercut	1/4" (7mm) recommended
Top and bottom latch case	4 1/2" x 2 1/8" x 1 1/2" (114mm x 54mm x 38mm)
Vertical rods	1/2" square tubing, standard rods accommodate 7' (2134mm) doors. Top rod length: 34 15/16" (887mm); Bottom rod length: 31 1/2" (794mm). Extension rods available in 3' (914mm) for doors over 7'; One piece top rod is available for 8' (2438mm) and 10' (3048mm) doors
Finishes	605, 606, 612, 625, 626/626AM, 628, 710, 711 and 643e (619 and 630 available with 98 Series only)
Fasteners and sex bolts (SNB)	Includes screw pack for 1 3/4" (44mm) to 2 1/4" (57mm) thick metal or wood doors, and 325 SNB for top and bottom latch. (Optional 425 SNB available)

### Features and options

#### Electrified options

- LX** Latch bolt monitor switch
- RX** Request to exit
- RX2** Double request to exit
- E** Electric locking and unlocking trim
- EL** Electric latch retraction
- QEL** Quiet electric latch retraction
- SS** Signal switch
- CX** Chexit delayed exit
- ALK** Alarm exit kit
- WP-RX** Waterproof request to exit
- CON** Allegion Connect

#### Mechanical options

- AX** Accessible device
- GBK** Glass bead kit
- LBR** Less bottom rod
- PL** Pullman latch
- PN** Pneumatic latch retraction
- QM** Quiet mechanical
- SNB** Sex bolts
- SEC** Security screws
- WH** Weep holes
- WS** Tornado and hurricane tested

#### Dogging feature

Hex key dogging standard

#### Dogging options

- CD** Cylinder dogging
- CDSI** Cylinder dogging with security indicator
- HDSI** Hex dogging with security indicator
- SD** Special center case dogging
- LD** Less dogging
- DI** Dogging indicator
- CI** Cylinder dogging indicator

#### Strikes

- Top – 299 – Dull black**
- Bottom – 248L4 and 304L – Unfinished**

### Accessories



**299 Top strike**



**Top latch**

**Bottom latch**



**304L Bottom strike**



**248L4 Bottom strike**  
For use with flat threshold



**Hex key dogging**  
Comes standard on 9827/9927 devices.

## Device types

# 9827-F/9927-F Surface mounted vertical rod fire device



9827-F/9927-F Fire exit surface mounted vertical rod device are certified to ANSI/BHMA A156.3 2014, Grade 1 and UL listed for fire exit hardware. See page 67 for detailed information on UL fire exit hardware label and door opening size information. The 9827-F device has a smooth mechanism case and the 9927-F device has a grooved case. The surface vertical rod device is non-handed except when the following device options are used: SS (signal switch), and WS (tornado/hurricane). Vertical rod and latch guards are available to protect the bottom rod of the exit device from damage by impacts of carts or gurneys passing through doors. Rod and latch guards can be used on hollow metal or tin clad composite fire doors.

### Specifications

Device functions	Device ships EO/DT/NL; Field selectable; For TP, K or L remove NL drive screw from device
Device lengths	2' 2' (610 mm) Door size 3' 2'4" to 3' (711mm to 914 mm) Door size 4' 2'10" to 4' (864 mm to 1219 mm) Door size
Device centerline from finished floor	39 5/8" (1006 mm)
Center case	8" x 2 3/4" x 2 3/8" (203mm x 70mm x 60mm)
Mechanism case	2 1/4" x 2 1/4" (57mm x 57mm)
Projection	Pushbar neutral – 3 13/16" (97 mm) Pushbar depressed – 3 1/16" (78 mm)
Latch bolt	Deadlocking anti-friction top and bottom bolt, 5/8" (16mm) throw
Door undercut	1/4" (7mm) recommended
Top and bottom latch case	4 1/2" x 2 1/8" x 1 1/2" (114mm x 54mm x 38mm)
Vertical rods	1/2" square tubing, standard rods accommodate 7' (2134mm) doors. Top rod length: 34 15/16" (887mm); Bottom rod length: 31 1/2" (794mm). Extension rods available in 3' (914mm) for doors over 7' One piece top rod is available for 8' (2438mm) and 10' (3048mm) doors
Finishes	605, 606, 612, 625, 626/626AM, 628, 710, 711 and 643e (619 and 630 available with 98 Series only)
Fasteners and sex bolts (SNB)	Includes screw pack for 1 3/4" (44mm) to 2 1/4" (57mm) thick metal or wood doors, and 325 SNB for top and bottom latch (Optional 425 SNB available)

### Accessories

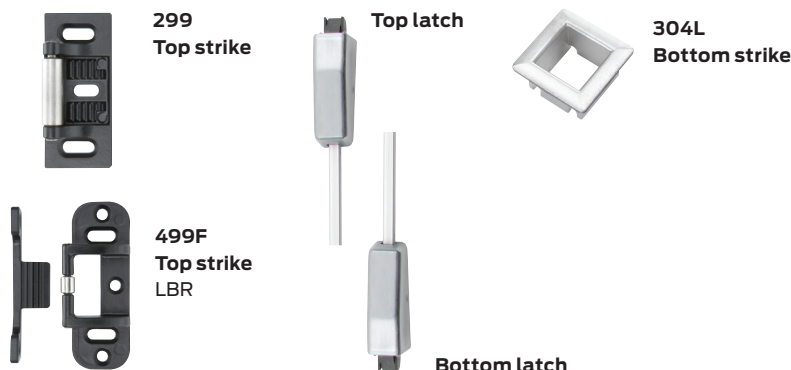

### Features and options

#### Electrified options

<b>LX</b>	Latch bolt monitor switch
<b>RX</b>	Request to exit
<b>RX2</b>	Double request to exit
<b>E</b>	Electric locking and unlocking trim
<b>EL</b>	Electric latch retraction
<b>QEL</b>	Quiet electric latch retraction
<b>SS</b>	Signal switch
<b>CX</b>	Chexit delayed exit
<b>ALK</b>	Alarm exit kit
<b>WP-RX</b>	Waterproof request to exit
<b>CON</b>	Alliection Connect

#### Mechanical options

<b>AX</b>	Accessible device (LBR only)
<b>GBK</b>	Glass bead kit
<b>LBR</b>	Less bottom rod
<b>PL</b>	Pullman latch
<b>PN</b>	Pneumatic latch retraction
<b>QM</b>	Quiet mechanical
<b>SNB</b>	Sex bolts
<b>SEC</b>	Security screws
<b>SLM</b>	Special laminate material blocking
<b>WH</b>	Weep holes
<b>WS</b>	Tornado and hurricane tested

#### Dogging option

No mechanical dogging;  
EL and QEL options available

#### Strikes

**Top – 299F** – (499F LBR) Dull black  
**Bottom – 304L** – Unfinished

# 9857/9957 Three-point latching device



9857/9957 Three-point latching device for all types of single or double doors, UL listed for panic exit hardware. Devices are ANSI A156.3 – 2008 Grade 1. Covers stock hollow metal doors with 86 or 161 cutouts. The 9857 device has a smooth mechanism case and the 9957 device has a grooved case. The three-point latching device is non-handed except when the following device options are used: SD (special dogging), SS (signal switch), or WS (windstorm). Vertical rod and latch guards are available to protect the bottom rod of the exit device from damage by impacts of carts or gurneys passing through doors.

### Specifications

Device functions	Device ships EO/DT/NL; Field selectable; For TP, K or L remove NL drive screw from device.
Device lengths	3' 2 1/4' to 3' (711mm to 914mm) Door size 4' 2 1/10" to 4' (864mm to 1219mm) Door size
Device centerline from finished floor	39 13/16" (1011mm)
Center case	8" x 2 3/4" x 2 3/8" (203mm x 70mm x 60mm)
Mechanism case	2 1/4" x 2 1/4" (57mm x 57mm)
Projection	Pushbar neutral – 3 13/16" (97mm) Pushbar depressed – 3 1/16" (78mm)
Latch bolt	Deadlocking anti-friction top and bottom bolt, 5/8" (16mm) throw; Deadlocking rim bolt, 3/4" (19mm) throw
Door undercut	1/4" (7mm) recommended
Top and bottom latch case	4 1/2" x 2 1/8" x 1 1/2" (114mm x 54mm x 38mm)
Vertical rods	1/2" square tubing, standard rods accommodate 7' (2134mm) doors. Top rod length: 34 15/16" (887mm); Bottom rod length: 31 1/2" (794mm). Extension rods available in 3' (914mm) for doors over 7'. One piece top rod is available for 8' (2438mm) and 10' (3048mm) doors.
Finishes	605, 606, 612, 625, 626/626AM, 628, 710, 711 and 643e (619 and 630 available with 98 Series only)
Fasteners and sex bolts (SNB)	Includes screw pack for 1 3/4" (44mm) to 2 1/4" (57mm) thick metal or wood doors, and 325 SNB for top and bottom latch (Optional 425 SNB available)

### Features and options

#### Electrified options

<b>LX</b>	Latch bolt monitor switch
<b>RX</b>	Request to exit
<b>RX2</b>	Double request to exit
<b>E</b>	Electric locking and unlocking trim
<b>EL</b>	Electric latch retraction
<b>QEL</b>	Quiet electric latch retraction
<b>SS</b>	Signal switch
<b>CX</b>	Chexit delayed exit
<b>ALK</b>	Alarm exit kit
<b>WP-RX</b>	Waterproof request to exit
<b>CON</b>	Alligion Connect

#### Mechanical options

<b>GBK</b>	Glass bead kit
<b>PL</b>	Pullman latch
<b>PN</b>	Pneumatic latch retraction
<b>SNB</b>	Sex bolts
<b>SEC</b>	Security screws
<b>WH</b>	Weep holes
<b>WS</b>	Tornado and hurricane tested

#### Dogging feature

Hex key dogging standard

#### Dogging options

<b>CD</b>	Cylinder dogging
<b>CD-CX</b>	Chexit cylinder dogging
<b>CDSI</b>	Cylinder dogging with security indicator
<b>HDSI</b>	Hex dogging with security indicator
<b>SD</b>	Special center case dogging
<b>LD</b>	Less dogging
<b>DI</b>	Dogging indicator
<b>CI</b>	Cylinder dogging indicator

#### Strikes

**Top and middle – 299 – Dull black**  
**Bottom – 248L4 and 304L – Unfinished**

### Accessories



**299**  
**Top and middle strike**



**Top latch**



**304L**  
**Bottom strike**



**248L4**  
**Bottom strike**  
For use with flat threshold



**Bottom latch**



**Hex key dogging**  
Comes standard on 9857/9957 three point latching devices.

## Device types

# 9857-F/9957-F Three-point latching fire exit device



9857-F/9957-F Fire exit three-point latching device are UL listed for fire exit hardware. See page 67 for detailed information on UL listed fire exit hardware label and door opening size information. Devices are ANSI A156.3 – 2008 Grade 1. The 9857-F device has a smooth mechanism case and the 9957-F device has a grooved case. The three-point latch device is non-handed except when the following device option is used: SS (signal switch) or WS (windstorm). Vertical rod and latch guards are available to protect the bottom rod of the exit device from damage by impacts of carts or gurneys passing through doors.

### Specifications

Device functions	Device ships EO/DT/NL; Field selectable; For TP, K or L remove NL drive screw from device
Device lengths	3' 2 1/4' to 3' (711mm to 914mm) Door size 4' 2'10" to 4' (864 mm to 1219mm) Door size
Device centerline from finished floor	39 13/16" (1011mm)
Center case	8" x 2 3/4" x 2 3/8" (203mm x 70mm x 60mm)
Mechanism case	2 1/4" x 2 1/4" (57mm x 57mm)
Projection	Pushbar neutral – 3 13/16" (97mm) Pushbar depressed – 3 1/16" (78mm)
Latch bolt	Deadlocking anti-friction top and bottom bolt, 5/8" (16mm) throw; Deadlocking rim bolt, 3/4" (19mm) throw
Door undercut	1/4" (7mm) recommended
Top and bottom Latch case	4 1/2" x 2 1/8" x 1 1/2" (114mm x 54mm x 38mm)
Vertical rods	1/2" square tubing, standard rods accommodate 7' (2134mm) doors. Top rod length: 34 15/16" (887mm); Bottom rod length: 31 1/2" (794mm). Extension rods available 3' (914mm) for doors over 7'. One piece top rod is available for 8' (2438mm) and 10' (3048mm) doors.
Finishes	605, 606, 612, 625, 626/626AM, 628, 710, 711 and 643e (619 and 630 available with 98 Series only)
Fasteners and sex bolts (SNB)	Includes screw pack for 1 3/4" (44mm) and 2 1/4" (57mm) thick metal or wood doors, and 325 SNB for top and bottom latch. (Optional 425 SNB available for metal doors; 825 SNB required on wood doors without SLM blocking)

### Accessories

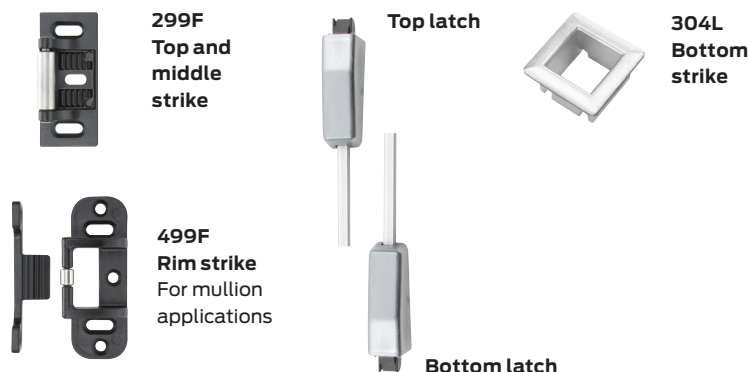

### Features and options

#### Electrified options

<b>LX</b>	Latch bolt monitor switch
<b>RX</b>	Request to exit
<b>RX2</b>	Double request to exit
<b>E</b>	Electric locking and unlocking trim
<b>EL</b>	Electric latch retraction
<b>QEL</b>	Quiet electric latch retraction
<b>SS</b>	Signal switch
<b>CX</b>	Chexit delayed exit
<b>ALK</b>	Alarm exit kit
<b>WP-RX</b>	Waterproof request to exit
<b>CON</b>	Alligion Connect

#### Mechanical options

<b>GBK</b>	Glass bead kit
<b>PN</b>	Pneumatic latch retraction
<b>SNB</b>	Sex bolts
<b>SEC</b>	Security screws
<b>SLM</b>	Special laminate material blocking
<b>WH</b>	Weep holes
<b>WS</b>	Tornado and hurricane tested

#### Dogging option

No mechanical dogging;  
EL and QEL options available

#### Strikes

**Top and middle – 299F – Dull black**  
**Bottom – 304L – Unfinished**

# 9847/9947 Concealed vertical rod device

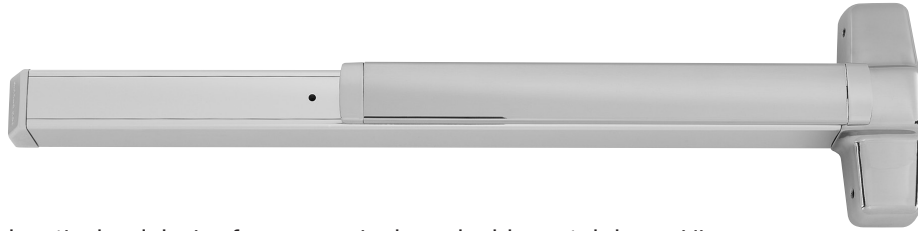

9847/9947 Concealed vertical rod device for use on single or double metal doors, UL listed for panic exit hardware. These are certified to ANSI/BHMA A156.3 2014, Grade 1. The 9847 device has a smooth mechanism case and the 9947 device has a grooved case. The concealed vertical rod device is non-handed except when the following device options are used: SD (special dogging), or SS (signal switch).

### Specifications

Device functions	Device ships EO/DT/NL; Field selectable; For TP, K or L remove NL drive screw from device.
Device lengths	2' 2' (610mm) Door size 3' 2'4" to 3' (711mm to 914mm) Door size 4' 2'10" to 4' (864mm to 1219mm) Door size
Device centerline from finished floor	39 5/8" (1006 mm) Standard Adjustable from 35 5/8" (905mm) to 49 5/8" (1260mm)
Center case	8" x 2 3/4" x 2 3/8" (203mm x 70mm x 60mm)
Mechanism case	2 1/4" x 2 1/4" (57mm x 57mm)
Projection	Pushbar neutral – 3 13/16" (97mm) Pushbar depressed – 3 1/16" (78mm)
Latch bolt	Deadlocking top and bottom bolt, 5/8" (16mm) throw
Door undercut	1/4" (7mm) recommended
Top and bottom latch case	4 1/2" x 2 1/8" x 1 1/2" (114mm x 54mm x 38mm)
Vertical rods	Round 2-piece adjustable rods – Top rod adjustable from 6'8" (2027mm) to 8'4" (2533mm). Bottom rod adjustable 35 5/8" (905mm) to 49 5/8" (1260mm). Extension rod kits available for doors over 8'4" (2533mm).
Finishes	605, 606, 612, 625, 626/626AM, 628, 710, 711 and 643e (619 and 630 available with 98 Series only)
Fasteners and sex bolts (SNB)	Includes screw pack for 1 3/4" (44mm) to 2 1/4" (57mm) thick metal doors (Optional 425 SNB available)

### Features and options

#### Electrified options

- LX** Latch bolt monitor switch
- RX** Request to exit
- RX2** Double request to exit
- E** Electric locking and unlocking trim
- EL** Electric latch retraction
- QEL** Quiet electric latch retraction
- SS** Signal switch
- CX** Chexit delayed exit
- ALK** Alarm exit kit
- WP-RX** Waterproof request to exit
- CON** Allegion Connect

#### Mechanical options

- GBK** Glass bead kit
- LBR** Less bottom rod
- PL** Pullman latch
- PN** Pneumatic latch retraction
- SNB** Sex bolts
- SEC** Security screws
- WH** Weep holes

#### Dogging feature

Hex key dogging standard

#### Dogging options

- CD** Cylinder dogging
- CD-CX** Chexit cylinder dogging
- CDSI** Cylinder dogging with security indicator
- HDSI** Hex dogging with security indicator
- SD** Special center case dogging
- LD** Less dogging
- DI** Dogging indicator
- CI** Cylinder dogging indicator

#### Strikes

- Top – 338** – Unfinished
- Bottom – 385A** – Unfinished

### Accessories

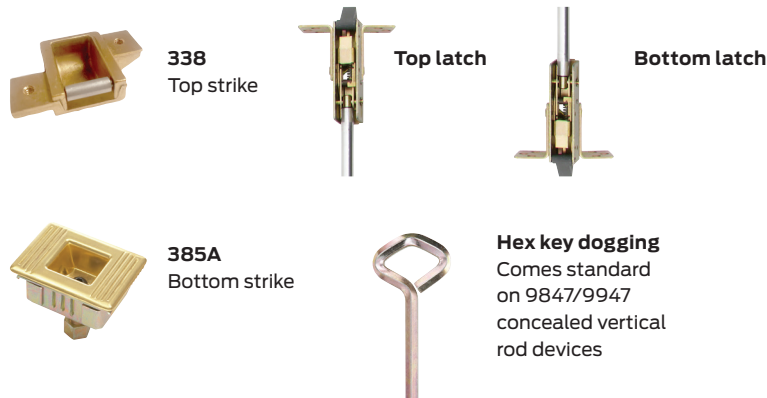



## Device types

# 9847-F/9947-F Concealed vertical rod fire exit device

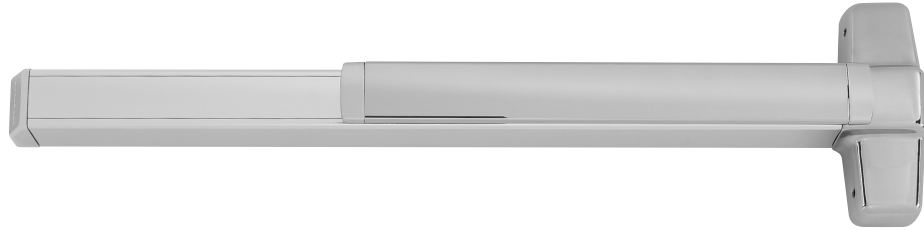

9847-F/9947-F Fire exit concealed vertical rod device are certified to ANSI/BHMA A156.3 2014, Grade 1 and UL listed for fire exit hardware. See page 67 for detailed information on UL fire exit hardware label and door opening size information. The 9847-F device has a smooth mechanism case and the 9947-F device has a grooved case. The concealed vertical rod device is non-handed except when the following device option is used: SS (signal switch) devices.

### Specifications

Device functions	Device ships EO/DT/NL; Field selectable; For TP, K or L remove NL drive screw from device
Device lengths	2' 2' (610 mm) Door size 3' 2'4" to 3' (711mm to 914mm) Door size 4' 2'10" to 4' (864mm to 1219mm) Door size
Device centerline from finished floor	39 <sup>5</sup> / <sub>8</sub> " (1006 mm) Standard Adjustable from 35 <sup>5</sup> / <sub>8</sub> " (905mm) to 49 <sup>5</sup> / <sub>8</sub> " (1260mm)
Center case	8" x 2 <sup>3</sup> / <sub>4</sub> " x 2 <sup>3</sup> / <sub>8</sub> " (203mm x 70mm x 60mm)
Mechanism case	2 <sup>1</sup> / <sub>4</sub> " x 2 <sup>1</sup> / <sub>4</sub> " (57mm x 57mm)
Projection	Pushbar neutral – 3 <sup>13</sup> / <sub>16</sub> " (97mm) Pushbar depressed – 3 <sup>1</sup> / <sub>16</sub> " (78mm)
Latch bolt	Deadlocking top and bottom bolt, <sup>5</sup> / <sub>8</sub> " (16mm) throw
Door undercut	<sup>1</sup> / <sub>4</sub> " (7mm) recommended
Top and bottom latch case	3 <sup>3</sup> / <sub>4</sub> " x 1 <sup>1</sup> / <sub>2</sub> " x 1" (95mm x 38mm x 25mm)
Vertical rods	Round 2-piece adjustable rods – Top rod adjustable from 6'8" (2027mm) to 8'4" (2533mm). Bottom rod adjustable 35 <sup>5</sup> / <sub>8</sub> " (905mm) to 49 <sup>5</sup> / <sub>8</sub> " (1260mm) Extension rod kits available for doors over 8'4" (2533mm)
Finishes	605, 606, 612, 625, 626/626AM, 628, 710, 711 and 643e (619 and 630 available with 98 Series only)
Fasteners and sex bolts (SNB)	Includes screw pack for 1 <sup>3</sup> / <sub>4</sub> " (44mm) to 2 <sup>1</sup> / <sub>4</sub> " (57mm) thick metal doors (Optional 425 SNB available)

### Accessories

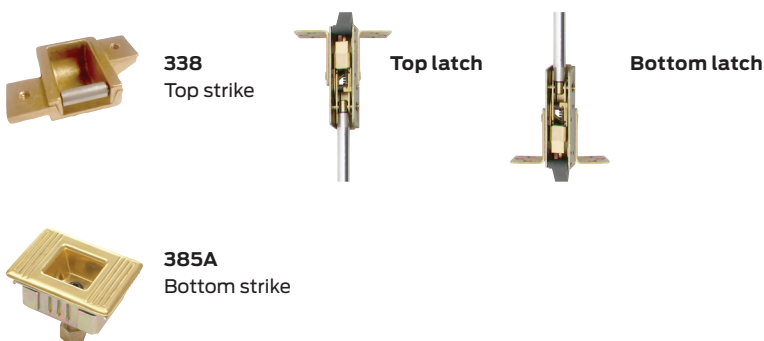

### Features and options

#### Electrified options

<b>LX</b>	Latch bolt monitor switch
<b>RX</b>	Request to exit
<b>RX2</b>	Double request to exit
<b>E</b>	Electric locking and unlocking trim
<b>EL</b>	Electric latch retraction
<b>QEL</b>	Quiet electric latch retraction
<b>SS</b>	Signal switch
<b>CX</b>	Chexit delayed exit
<b>ALK</b>	Alarm exit kit
<b>WP-RX</b>	Waterproof request to exit
<b>CON</b>	Allegion Connect

#### Mechanical options

<b>GBK</b>	Glass bead kit
<b>LBR</b>	Less bottom rod
<b>PN</b>	Pneumatic latch retraction
<b>SNB</b>	Sex bolts
<b>SEC</b>	Security screws
<b>SLM</b>	Special laminate material blocking
<b>WH</b>	Weep holes

#### Dogging option

No mechanical dogging;  
EL and QEL options available

#### Strikes

**Top – 338** – Unfinished  
**Bottom – 385A** – Unfinished

# 9848/9948 Concealed vertical rod device

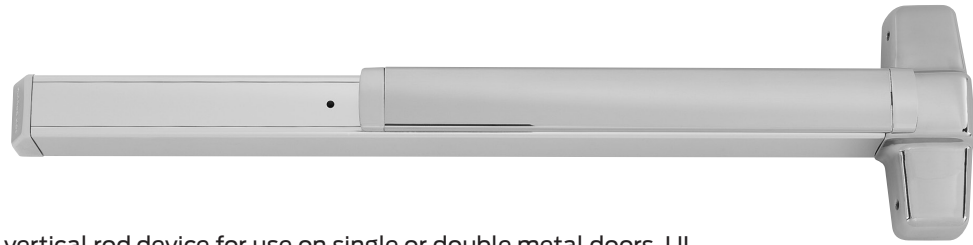

9848/9948 Concealed vertical rod device for use on single or double metal doors, UL listed for panic exit hardware. These are certified to ANSI/BHMA A156.3 2014, Grade 1. Covers stock hollow metal doors with 86 or 161 cutouts. The 9848 device has a smooth mechanism case and the 9948 device has a grooved case. The concealed vertical rod device is non-handed except when the following device options are used: SD (special dogging), or SS (signal switch).

### Specifications

Device functions	Device ships EO/DT/NL; Field selectable; For TP, K or L remove NL drive screw from device
Device lengths	2' 2' (610 mm) Door size 3' 2'4" to 3' (711mm to 914mm) Door size 4' 2'10" to 4' (864mm to 1219mm) Door size
Device centerline from finished floor	39 5/8" (1006 mm) Standard Adjustable from 35 5/8" (905mm) to 49 5/8" (1260mm)
Center case	8" x 2 3/4" x 2 3/8" (203mm x 70mm x 60mm)
Mechanism case	2 1/4" x 2 1/4" (57mm x 57mm)
Projection	Pushbar neutral – 3 13/16" (97 mm) Pushbar depressed – 3 1/16" (78mm)
Latch bolt	Deadlocking top bolt, 5/8" (16mm) throw Deadlocking bottom bolt, 1 1/2" (38mm) throw
Door undercut	3/4" (19mm) maximum, more than 1/4" minimum
Top and bottom latch case	4 1/4" x 1 1/2" x 1 1/8" (107mm x 38mm x 28mm)
Vertical rods	Round 2-piece adjustable rods – Top rod adjustable from 6'8" (2027mm) to 8'4" (2533mm). Bottom rod adjustable 35 5/8" (905 mm) to 49 5/8" (1260 mm). Extension rod kits available for doors over 8'4" (2533mm).
Finishes	605, 606, 612, 625, 626/626AM, 628, 710, 711 and 643e (619 and 630 available with 98 Series only)
Fasteners and sex bolts (SNB)	Includes screw pack for 1 3/4" (44mm) to 2 1/4" (57mm) thick metal doors (Optional 425 SNB available)

### Features and options

#### Electrified options

- LX** Latch bolt monitor switch
- RX** Request to exit
- RX2** Double request to exit
- E** Electric locking and unlocking trim
- EL** Electric latch retraction
- QEL** Quiet electric latch retraction
- SS** Signal switch
- CX** Chexit delayed exit
- ALK** Alarm exit kit
- WP-RX** Waterproof request to exit
- CON** Allegion Connect

#### Mechanical options

- GBK** Glass bead kit
- PN** Pneumatic latch retraction
- SNB** Sex bolts
- SEC** Security screws
- WH** Weep holes

#### Dogging feature

Hex key dogging standard

#### Dogging options

- CD** Cylinder dogging
- CD-CX** Chexit cylinder dogging
- CDSI** Cylinder dogging with security indicator
- HDSI** Hex dogging with security indicator
- SD** Special center case dogging
- LD** Less dogging
- DI** Dogging indicator
- CI** Cylinder dogging indicator

#### Strikes

- Top – 338** – Unfinished
- Bottom – 385A** – Unfinished

### Accessories

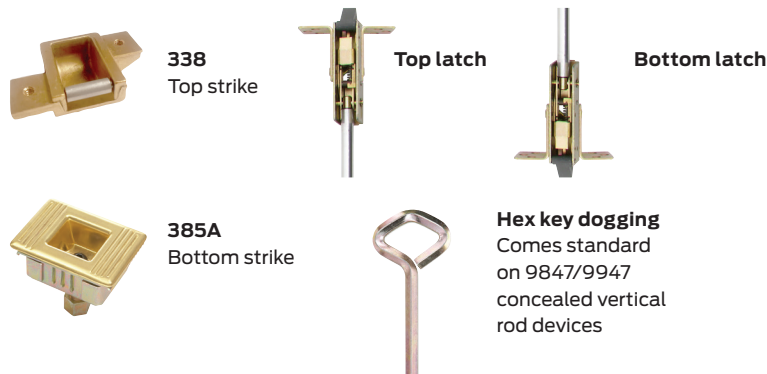

## Device types

# 9848-F/9948-F Concealed vertical rod fire exit device

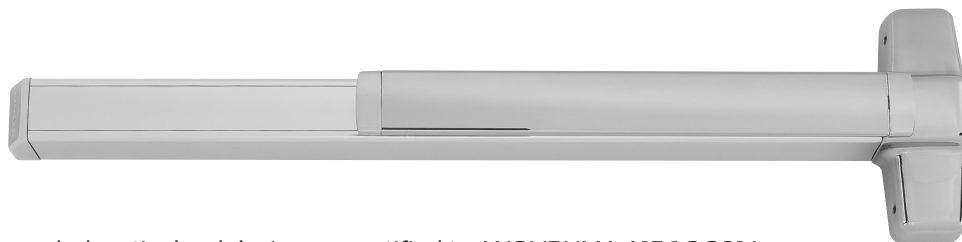

9848-F/9948-F Concealed vertical rod device are certified to ANSI/BHMA A156.3 2014, Grade 1 and UL listed for fire exit hardware. See page 67 for detailed information on UL listed fire exit hardware label and door opening size information. The 9848-F device has a smooth mechanism case and the 9948-F device has a grooved case. The concealed vertical rod device is non-handed except when the following device option is used: SS (signal switch).

### Specifications

Device functions	Device ships EO/DT/NL; Field selectable; For TP, K or L remove NL drive screw from device
Device lengths	2' 2' (610mm) Door size 3' 2'4" to 3' (711mm to 914mm) Door size 4' 2'10" to 4' (864mm to 1219mm) Door size
Device centerline from finished floor	39 5/8" (1006mm) Standard Adjustable from 35 5/8" (905mm) to 49 5/8" (1260mm)
Center case	8" x 2 3/4" x 2 3/8" (203mm x 70mm x 60mm)
Mechanism case	2 1/4" x 2 1/4" (57mm x 57mm)
Projection	Pushbar neutral – 3 13/16" (97mm) Pushbar depressed – 3 1/16" (78mm)
Latch bolt	Deadlocking top bolt, 5/8" (16mm) throw Deadlocking bottom bolt, 1 1/2" (38mm) throw
Door undercut	3/4" (19mm) maximum, more than 1/4" minimum
Top and bottom Latch case	4 1/4" x 1 1/2" x 1 1/8" (107mm x 38mm x 28mm)
Vertical rods	Round 2-piece adjustable rods – Top rod adjustable from 6'8" (2027mm) to 8'4" (2533mm). Bottom rod adjustable 35 5/8" (905mm) to 49 5/8" (1260 mm). Extension rod kits available for doors over 8'4" (2533mm).
Finishes	605, 606, 612, 625, 626/626AM, 628, 710, 711 and 643e (619 and 630 available with 98 Series only)
Fasteners and sex bolts (SNB)	Includes screw pack for 1 3/4" (44mm) to 2 1/4" (57mm) thick metal doors. (Optional 425 SNB available)

### Features and options

#### Electrified options

<b>LX</b>	Latch bolt monitor switch
<b>RX</b>	Request to exit
<b>RX2</b>	Double request to exit
<b>E</b>	Electric locking and unlocking trim
<b>EL</b>	Electric latch retraction
<b>QEL</b>	Quiet electric latch retraction
<b>SS</b>	Signal switch
<b>CX</b>	Chexit delayed exit
<b>ALK</b>	Alarm exit kit
<b>WP-RX</b>	Waterproof request to exit
<b>CON</b>	Allegion Connect

#### Mechanical options

<b>GBK</b>	Glass bead kit
<b>PN</b>	Pneumatic latch retraction
<b>SNB</b>	Sex bolts
<b>SEC</b>	Security screws
<b>SLM</b>	Special laminate material blocking
<b>WH</b>	Weep holes

#### Dogging option

No mechanical dogging;  
EL and QEL options available

#### Strikes

**Top – 338** – Unfinished  
**Bottom – 385A** – Unfinished

### Accessories

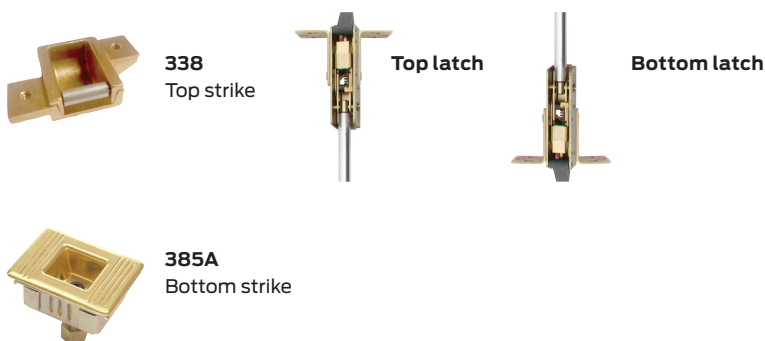

# 9849/9949 Concealed vertical cable device

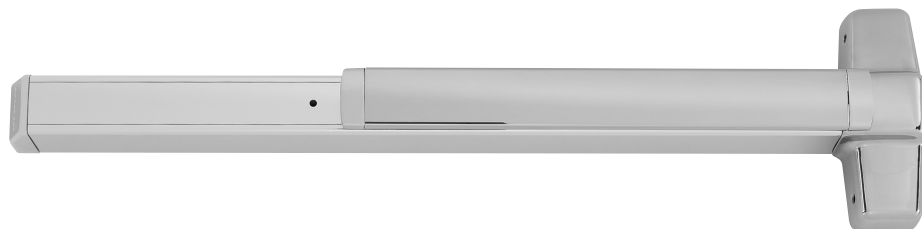

9849/9949 Concealed vertical cable device for use on single or double metal doors, UL listed for panic exit hardware. These are certified to ANSI/BHMA A156.3 2014, Grade 1. The 9849 device has a smooth mechanism case and the 9949 device has a grooved case. The concealed vertical cable device is non-handed except when the following device options are used: SD (special dogging), or SS (signal switch).

### Specifications

Device functions	Device ships EO/DT/NL; Field selectable; For TP, K or L remove NL drive screw from device.
Device lengths	2' 2' (610 mm) Door size 3' 2'4" to 3' (711mm to 914mm) Door size 4' 2'10" to 4' (864mm to 1219mm) Door size
Device centerline from finished floor	39 5/8" (1006 mm)
Center case	8" x 2 3/4" x 2 3/8" (203mm x 70mm x 60mm)
Mechanism case	2 1/4" x 2 1/4" (57mm x 57mm)
Projection	Pushbar neutral – 3 13/16" (97mm) Pushbar depressed – 3 1/16" (78mm)
Latch bolt	Deadlocking top and bottom bolt, 1/2" (13mm) throw
Door undercut	3/4" (19mm) maximum (24231516 spacer block kit needed for 3/4" undercut)
Top and bottom latch case	5 13/16" x 1 1/4" x 1 7/16" (147mm x 32mm x 37mm)
Vertical cable	7/32" (6mm) Diameter stainless steel cables
Finishes	605, 606, 612, 625, 626/626AM, 628, 710, 711 and 643e (619 and 630 available with 98 Series only)
Fasteners and sex bolts (SNB)	Includes screw pack for 1 3/4" (44mm) to 2 1/4" (57mm) thick metal doors (Optional 425 SNB available)

### Features and options

#### Electrified options

- LX\*** Latch bolt monitor switch
- RX** Request to exit
- RX2** Double request to exit
- E** Electric locking and unlocking trim
- EL** Electric latch retraction
- QEL** Quiet electric latch retraction
- SS** Signal switch
- CX** Chexit delayed exit
- ALK** Alarm exit kit
- WP-RX** Waterproof request to exit
- CON** Allegion Connect

#### Mechanical options

- AX** Accessible device
- GBK** Glass bead kit
- LBL** Less bottom latch
- PN** Pneumatic latch retraction
- SG** Safety glow
- SNB** Sex bolts
- SEC** Security screws
- WH** Weep holes

#### Dogging option

No mechanical dogging;  
EL and QEL options available

#### Dogging options

- CD** Cylinder dogging
- CD-CX** Chexit cylinder dogging
- CDSI** Cylinder dogging with security indicator
- HDSI** Hex dogging with security indicator
- SD** Special center case dogging
- LD** Less dogging
- DI** Dogging indicator
- CI** Cylinder dogging indicator

#### Strikes

- Top – 249** – Unfinished
- Bottom – 349** – Unfinished

\*For 98/9949 devices, LX switch monitors trim input or electric dogging of EL/QEL devices. LX switch does not monitor latch bolt condition.

## Device types

# 9849/9949 Concealed vertical cable device

### Accessories

#### 249 Top strike



#### 349 Bottom strike



#### 338 Filler plate (retrofit bracket)



#### Top latch



#### Center slide



#### Bottom latch

#### Cable detail



#### Hex key dogging

Comes standard on 9849/9949 concealed vertical cable devices

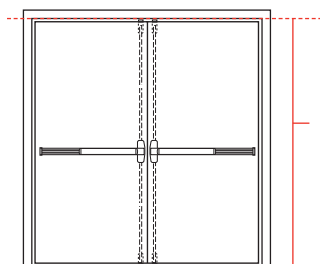

**Door opening height**  
is distance from bottom of frame header to finished floor.

See table on left for standard offering.

Nominal door opening height		Top cable part number	Bottom cable part number
72" - 82"	6'0" - 6'10"	47250398	47250403
<b>*82" - 96"</b>	<b>*6'10" - 8'</b>	<b>47250175</b>	<b>47250178</b>
>96" - 110"	>8'0" - 9' 2"	47250176	47250179
>110" - 120"	>9'2" - 10'	47250177	47250180

\*Default door opening height. Specify door opening height if other than the default. For door heights less than 6'0" and greater than 10', contact our Customer Care department to discuss your specific application needs.

# 9849-F/9949-F Concealed vertical cable fire exit device



98/9949-F Concealed vertical cable devices are certified to ANSI/BHMA A156.3 2014, Grade 1 and UL listed for fire exit hardware. See page 67 for detailed information on UL listed fire exit hardware label and door opening size information. The 9849 device has a smooth mechanism case and the 9949 device has a grooved case. The concealed vertical cable device is non-handed except when the following device options are used: SD (special dogging), or SS (signal switch).

### Specifications

Device functions	Device ships EO/DT/NL; Field selectable; For TP, K or L remove NL drive screw from device
Device lengths	2' 2' (610 mm) Door size 3' 2'4" to 3' (711mm to 914mm) Door size 4' 2'10" to 4' (864mm to 1219mm) Door size
Device centerline from finished floor	39 5/8" (1006 mm) Standard
Center case	8" x 2 3/4" x 2 3/8" (203mm x 70mm x 60mm)
Mechanism case	2 1/4" x 2 1/4" (57mm x 57mm)
Projection	Pushbar neutral – 3 13/16" (97mm) Pushbar depressed – 3 1/16" (78mm)
Latch bolt	Deadlocking anti-friction top and bottom bolt, 5/8" (16mm) throw
Door undercut	3/4" (19mm) maximum (24231516 spacer block kit needed for 3/4" undercut)
Top and bottom Latch case	5 13/16" x 1 1/4" x 1 7/16" (147mm x 32mm x 37mm)
Vertical cable	7/32" (6mm) Diameter stainless steel cables
Finishes	605, 606, 612, 625, 626/626AM, 628, 710, 711 and 643e (619 and 630 available with 98 Series only)
Fasteners and sex bolts (SNB)	Includes screw pack for 1 3/4" (44mm) to 2 1/4" (57mm) thick metal doors (Optional 425 SNB available)

### Features and options

#### Electrified options

- LX\*** Latch bolt monitor switch
- RX** Request to exit
- RX2** Double request to exit
- E** Electric locking and unlocking trim
- EL** Electric latch retraction
- QEL** Quiet electric latch retraction
- SS** Signal switch
- CX** Chexit delayed exit
- ALK** Alarm exit kit
- WP-RX** Waterproof request to exit
- CON** Allegion Connect

#### Mechanical options

- AX** Accessible device
- GBK** Glass bead kit
- LBL** Less bottom latch
- PN** Pneumatic latch retraction
- SG** Safety glow
- SNB** Sex bolts
- SEC** Security screws
- WH** Weep holes

#### Dogging feature

Hex key dogging standard

#### Dogging options

- CD** Cylinder dogging
- CD-CX** Chexit cylinder dogging
- CDSI** Cylinder dogging with security indicator
- HDSI** Hex dogging with security indicator
- SD** Special center case dogging
- LD** Less dogging
- DI** Dogging indicator
- CI** Cylinder dogging indicator

#### Strikes

- Top – 249 – Unfinished**
- Bottom – 349 – Unfinished**

\*For 98/9949 devices, LX switch monitors trim input or electrified dogging of EL/QEL devices. LX switch does not monitor latch bolt condition.

## Device types

# 9849-F/9949-F Concealed vertical cable fire exit device

## Accessories

### 249 Top strike



### 349 Bottom strike



### 338 Filler plate (retrofit bracket)



### Top latch



### Center slide



### Bottom latch

### Cable detail



### Hex key dogging

Comes standard on 9849/9949 concealed vertical cable devices

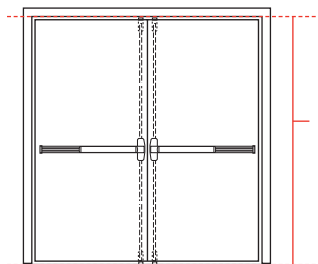

**Door opening height** is distance from bottom of frame header to finished floor.

See table on left for standard offering.

Nominal door opening height		Top cable part number	Bottom cable part number
72" - 82"	6'0" - 6'10"	47250398	47250403
<b>*82" - 96"</b>	<b>*6'10" - 8'</b>	<b>47250175</b>	<b>47250178</b>
>96" - 110"	>8'0" - 9' 2"	47250176	47250179
>110" - 120"	>9'2" - 10'	47250177	47250180

\*Default door opening height. Specify door opening height if other than the default. For door heights less than 6'0" and greater than 10', contact our Customer Care department to discuss your specific application needs.

# 9847WDC/9947WDC Wood door concealed vertical rod device

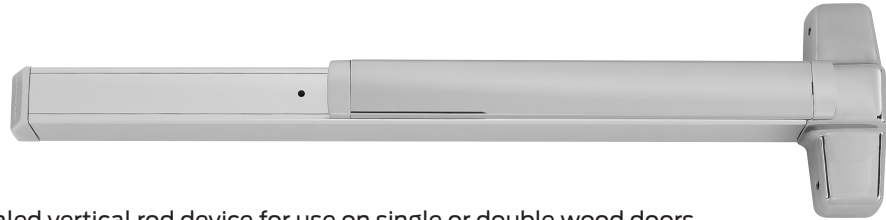

9847WDC/9947WDC Concealed vertical rod device for use on single or double wood doors, UL listed for panic exit hardware. Devices are certified to ANSI/BHMA A156.3 2014, Grade 1. The 9847WDC device has a smooth mechanism case and the 9947WDC device has a grooved case. The concealed vertical rod device is non-handed except when the following device options are used: SD (special dogging), or SS (signal switch).

### Specifications

Device functions	Device ships EO/DT/NL; Field selectable; For TP, K or L remove NL drive screw from device
Device lengths	2' 2' (610 mm) Door size 3' 2'4" to 3' (711mm to 914mm) Door size 4' 2'10" to 4' (864mm to 1219mm) Door size
Device centerline from finished floor	39 5/8" (1006mm) Standard Adjustable from 35 5/8" (905mm) to 49 5/8" (1260mm)
Center case	8" x 2 3/4" x 2 3/8" (203mm x 70mm x 60mm)
Mechanism case	2 1/4" x 2 1/4" (57mm x 57mm)
Projection	Pushbar neutral – 3 13/16" (97mm) Pushbar depressed – 3 1/16" (78mm)
Latch bolt	Deadlocking top bolt, 5/8" (16mm) throw
Door undercut	1/4" (7mm) maximum
Top and bottom Latch case	3 3/4" x 1 1/2" x 1" (95mm x 38mm x 25mm)
Vertical rods	Round 2-piece adjustable rods – Top rod adjustable from 6'8" (2027mm) to 8'4" (2533mm). Bottom rod adjustable 35 5/8" (905mm) to 49 5/8" (1260 mm). Extension rod kits available for doors over 8'4" (2533mm).
Scalp plate <sup>1</sup>	Device is furnished standard with an 8" (203mm) long scalp plate for easy access to rods
Finishes	605, 606, 612, 625, 626, 628 and 710 (619 and 630 available with 98 Series only)
Fasteners and sex bolts (SNB)	Includes screw pack for 1 3/4" (44mm) to 2 1/4" (57mm) thick wood doors. (425 SNB required on wood doors without SLM blocking)

1. Do not use on pair of doors with 9875/9975.

### Accessories

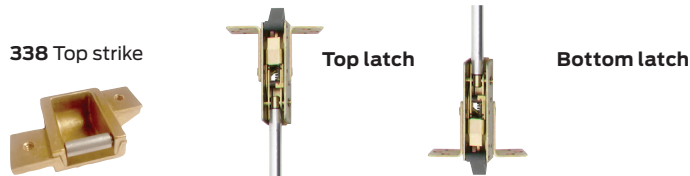

338 Top strike

Top latch

Bottom latch

385A Bottom strike

283 Top strike  
For use with wood frames



Hex key dogging  
Comes standard on 9847/9947 wood door concealed vertical rod devices

### Features and options

#### Electrified options

- LX** Latch bolt monitor switch
- RX** Request to exit
- RX2** Double request to exit
- E** Electric locking and unlocking trim
- EL** Electric latch retraction
- QEL** Quiet electric latch retraction
- SS** Signal switch
- CX** Chexit delayed exit
- ALK** Alarm exit kit
- WP-RX** Waterproof request to exit
- CON** Allegion Connect

#### Mechanical options

- GBK** Glass bead kit
- LBR** Less bottom rod
- PL** Pullman latch
- PN** Pneumatic latch retraction
- SNB** Sex bolts
- SEC** Security screws
- WH** Weep holes

#### Dogging feature

Hex key dogging standard

#### Dogging options

- CD** Cylinder dogging
- CDSI** Cylinder dogging with security indicator
- HDSI** Hex dogging with security indicator
- LD** Less dogging
- DI** Dogging indicator
- CI** Cylinder dogging indicator

#### Strikes

- Top – 338 – Unfinished**
- Bottom – 358A – Unfinished**



## Device types

# 9847WDC-F/9947WDC-F Wood door concealed vertical rod fire device



9847WDC-F/9947WDC-F Fire exit concealed vertical rod devices are certified to ANSI/BHMA A156.3 2014, Grade 1 and UL listed for fire exit hardware. See page 67 for detailed information on UL listed fire exit hardware label and door opening size information. The 9847WDC-F device has a smooth mechanism case and the 9947WDC-F device has a grooved case. The concealed vertical rod device is non-handed except when the following device options are used: SS (signal switch).

## Specifications

Device functions	Device ships EO/DT/NL; Field selectable; For TP, K or L remove NL drive screw from device
Device lengths	2' 2' (610 mm) Door size 3' 2'4" to 3' (711mm to 914 mm) Door size 4' 2'10" to 4' (864 mm to 1219 mm) Door size
Device centerline from finished floor	39 5/8" (1006 mm) Standard
Center case	8" x 2 3/4" x 2 3/8" (203mm x 70mm x 60mm)
Mechanism case	2 1/4" x 2 1/4" (57mm x 57mm)
Projection	Pushbar neutral – 3 13/16" (97 mm) Pushbar depressed – 3 1/16" (78 mm)
Latch bolt	Deadlocking top and bottom bolt, 5/8" (16mm) throw
Door undercut	1/4" (7mm) maximum
Top and bottom Latch case	3 3/4" x 1 1/2" x 1" (95mm x 38mm x 25mm)
Vertical rods	Round 2-piece adjustable rods – Top rod adjustable from 6'8" (2027mm) to 8'4" (2533mm). Bottom rod adjustable 35 5/8" (905 mm) to 49 5/8" (1260 mm). Extension rod kits available for doors over 8'4" (2533mm).
Scalp plate <sup>1</sup>	Device is furnished standard with an 8" (203mm) long scalp plate for easy access to rods
Finishes	605, 606, 612, 625, 626, 628, 710 (619 and 630 available with 98 Series only)
Fasteners and sex bolts (SNB)	Includes screw pack for 1 3/4" (44mm) to 2 1/4" (57mm) thick wood doors. (425 SNB required on wood doors without SLM blocking)

1. Do not use on pair of doors with 9875-F/9975-F.

## Features and options

### Electrified options

<b>LX</b>	Latch bolt monitor switch
<b>RX</b>	Request to exit
<b>RX2</b>	Double request to exit
<b>E</b>	Electric locking and unlocking trim
<b>EL</b>	Electric latch retraction
<b>QEL</b>	Quiet electric latch retraction
<b>SS</b>	Signal switch
<b>CX</b>	Chexit delayed exit
<b>ALK</b>	Alarm exit kit
<b>WP-RX</b>	Waterproof request to exit
<b>CON</b>	Allegion Connect

### Mechanical options

<b>GBK</b>	Glass bead kit
<b>LBR</b>	Less bottom rod
<b>PL</b>	Pullman latch
<b>PN</b>	Pneumatic latch retraction
<b>SNB</b>	Sex bolts
<b>SEC</b>	Security screws
<b>WH</b>	Weep holes

### Dogging option

No mechanical dogging;  
EL and QEL options available

### Strikes

**Top – 338** – Unfinished  
**Bottom – 385A** – Unfinished

## Accessories



**338**  
Top strike



**Top latch**



**Bottom latch**



**385A**  
Bottom strike

# 9850WDC/9950WDC Wood door concealed vertical cable device

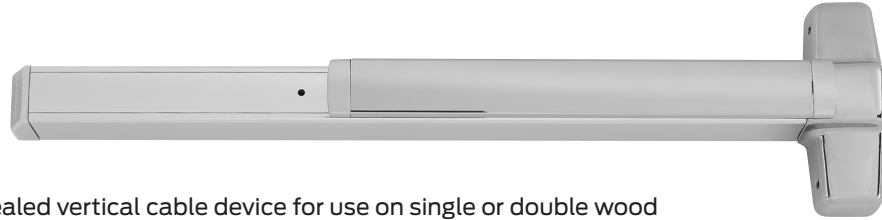

9850WDC/9950WDC Concealed vertical cable device for use on single or double wood doors, UL listed for panic exit hardware. Devices are certified to ANSI/BHMA A156.3 2014, Grade 1. The 9850WDC device has a smooth mechanism case and the 9950WDC device has a grooved case. The concealed vertical cable device is non-handed except when the following device options are used: SD (special dogging), or SS (signal switch).

### Specifications

Device functions	Device ships EO/DT/NL; Field selectable; For TP, K or L remove NL drive screw from device
Device lengths	2' 2' (610mm) Door size 3' 2'4" to 3' (711mm to 914mm) Door size 4' 2'10" to 4' (864mm to 1219 mm) Door size
Device centerline from finished floor	39 5/8" (1006mm) Standard
Center case	8" x 2 3/4" x 2 3/8" (203mm x 70mm x 60mm)
Mechanism case	2 1/4" x 2 1/4" (57mm x 57mm)
Projection	Pushbar neutral – 3 13/16" (97mm) Pushbar depressed – 3 1/16" (78mm)
Latch bolt	Deadlocking top and bottom bolt. 1 1/2" (38mm) throw
Door undercut	3/4" (19mm) maximum
Top and bottom Latch case	5 13/16" x 1 1/4" x 1 7/16" (147mm x 32mm x 37mm)
Vertical cables	7/32" (6mm) Diameter stainless steel cables
Scalp plate <sup>1</sup>	Device is furnished standard with a 15" (381mm) long scalp plate for easy access to cables
Finishes	605, 606, 612, 625, 626/626AM, 628, 710, 711 and 643e (619 and 630 available with 98 Series only)
Fasteners and sex bolts (SNB)	Includes screw pack for 1 3/4" (44mm) to 2 1/4" (57mm) thick wood doors.

1. Do not use on pair of doors with 9975 devices.

### Features and options

#### Electrified options

- LX\*** Latch bolt monitor switch
- RX** Request to exit
- RX2** Double request to exit
- RX996L** Trim monitor switch
- RX-LC** Request to exit low current
- E** Electric locking and unlocking trim
- EL** Electric latch retraction
- QEL** Quiet electric latch retraction
- SS** Signal switch
- CX** Chexit delayed exit
- ALK** Alarm exit kit
- WP-RX** Waterproof request to exit
- CON** Allegion Connect

#### Mechanical options

- AX** Accessible device
- GBK** Glass bead kit
- LBL** Less bottom latch
- PN** Pneumatic latch retraction
- SG** Safety glow
- SNB** Sex bolts
- SEC** Security screws
- WH** Weep holes

#### Dogging feature

Hex key dogging standard

#### Dogging options

- CD** Cylinder dogging
- CDSI** Cylinder dogging with security indicator
- HDSI** Hex dogging with security indicator
- SD** Special center case dogging
- LD** Less dogging
- DI** Dogging indicator
- CI** Cylinder dogging indicator

#### Strikes

- Top – 150 – Unfinished**
- Bottom – 450 – Unfinished**

\*For 98/9950WDC devices, LX switch monitors trim input or electrified dogging of EL/QEL devices. LX switch does not monitor latch bolt condition.

## Device types

# 9850WDC/9950WDC Wood door concealed vertical cable device

## Accessories

### 150 Top strike



### Top latch

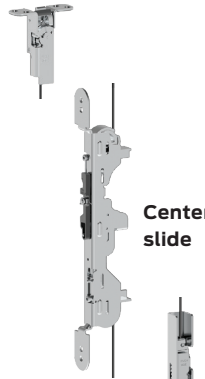

**Hex key dogging**  
Comes standard on 9850/9950 concealed vertical cable devices

### 450 Bottom strike



### Center slide



### 338 Filler plate (retrofit bracket)



### Bottom latch

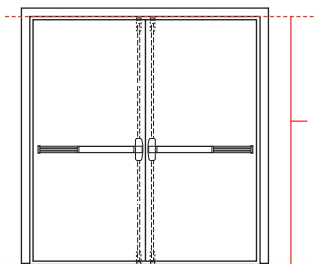

**Door opening height** is measured from finished floor to frame rabbet on door side.  
See table for standard offering.

### Standard door opening height

Feet	Cable tolerance
6'8" - 7'	72" - 84"
7'1" - 8'	85" - 96"
8'1" - 9'	97" - 108"
9'1" - 10'	109" - 120"

Note: Non-standard sizes available with extended lead time.  
Consult Customer Care for more information 1-877-671-7011.

# 9850WDC-F/9950WDC-F

## Wood door concealed vertical cable fire device

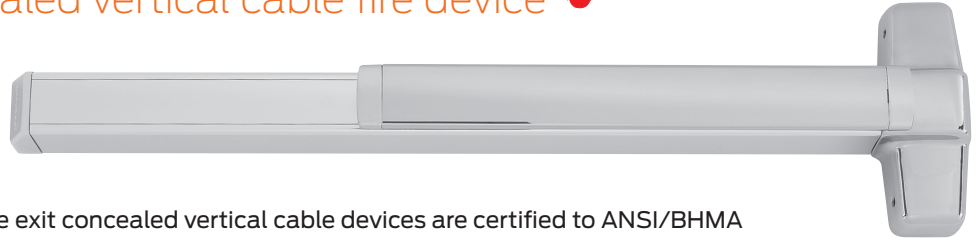

9850WDC-F/9950WDC-F Fire exit concealed vertical cable devices are certified to ANSI/BHMA A156.3 2014, Grade 1 and UL listed for fire exit hardware. See page 67 for detailed information on UL listed fire exit hardware label and door opening size information. The 9850WDC-F device has a smooth mechanism case and the 9950WDC-F device has a grooved case. The concealed vertical cable device is non-handed except when the following device options are used: SS (signal switch).

### Specifications

Device functions	Device ships EO/DT/NL; Field selectable; For TP, K or L remove NL drive screw from device.
Device lengths	2' 2' (610mm) Door size 3' 2'4" to 3' (711mm to 914mm) Door size 4' 2'10" to 4' (864mm to 1219mm) Door size
Device centerline from finished floor	39 5/8" (1006mm) Standard
Center case	8" x 2 3/4" x 2 3/8" (203mm x 70mm x 60mm)
Mechanism case	2 1/4" x 2 1/4" (57mm x 57mm)
Projection	Pushbar neutral – 3 13/16" (97mm) Pushbar depressed – 3 1/16" (78mm)
Latch bolt	Deadlocking top and bottom bolt, 1 1/2" (38mm) throw
Door undercut	3/4" (19mm) maximum
Top and bottom Latch case	5 13/16" x 1 1/4" x 1 7/16" (147mm x 32mm x 37mm)
Vertical cables	7/32" (6mm) Diameter stainless steel cables
Scalp plate <sup>1</sup>	Device is furnished standard with a 15" (381mm) long scalp plate for easy access to cables
Finishes	US3, US3A, US4, US4A, US10, US26, US26D, US26D-AM, US28, 313, 315 and 643e (US15 and US32D available with 98 Series only)
Fasteners and sex bolts (SNB)	Includes screw pack for 1 3/4" (44mm) to 2 1/4" (57mm) thick wood doors

1. Do not use on pair of doors with 9975 devices.

### Accessories

150 Top strike



450 Bottom strike



Top latch



Center slide

Bottom latch



338 Filler plate (retrofit bracket)

### Features and options

#### Electrified options

- LX\*** Latch bolt monitor switch
- RX** Request to exit
- RX2** Double request to exit
- RX996L** Trim monitor switch
- RX-LC** Request to exit low current
- E** Electric locking and unlocking trim
- EL** Electric latch retraction
- QEL** Quiet electric latch retraction
- SS** Signal switch
- CX** Chexit delayed exit
- ALK** Alarm exit kit
- WP-RX** Waterproof request to exit
- CON** Allegion Connect

#### Mechanical options

- AX** Accessible device
- GBK** Glass bead kit
- LBL** Less bottom latch
- PN** Pneumatic latch retraction
- SG** Safety glow
- SNB** Sex bolts
- SEC** Security screws
- SLM** Special laminate material blocking
- WH** Weep holes

#### Dogging option

No mechanical dogging; EL and QEL options available

#### Strikes

- Top – 150 – Unfinished**
- Bottom – 450 – Unfinished**

\*For 98/9950 devices, LX switch monitors trim input or electric dogging of EL/QEL devices. LX switch does not monitor latch bolt condition.

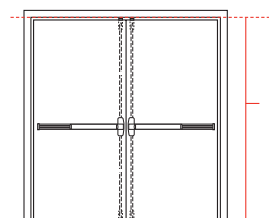

**Door opening height** is measured from finished floor to frame rabbet on door side.

See table for standard offering.

#### Standard door opening height

Feet	Cable tolerance
6'8" - 7'	72" - 84"
7'1" - 8'	85" - 96"
8'1" - 9'	97" - 108"
9'1" - 10'	109" - 120"

Note: Non-standard sizes available with extended lead time. Consult Customer Care for more information 1-877-671-7011.

## 98/9952 Rim with remote trim input (pool exit hardware)

Openings beyond the interior often have additional functional requirements that go beyond the limits of standard door hardware. Von Duprin offers the safety of panic hardware for pool enclosures, tested to withstand corrosive cleaners typically used in outdoor pool environments. Both the device and trim are built with weather resistant components that can withstand the harsh conditions of various climates. Understanding that hardware solutions need to be flexible and configurable, the Von Duprin 98/9952 with 252L trim is designed to meet the very specific needs of outdoor pool areas.

Engineered to be installed easily, the 98/9952 device can be mounted within the required range by the model codes and accessibility standards, while the 252L trim is mounted at least 54" from finished floor or concrete. Gate poles must have at least 3" stile width by 2" depth for ideal installation.

### Compliance

- Listed with UL for panic exit hardware (UL 305)
- Certified to ANSI/BHMA A156.3 2014, Grade 1
- Meets International Building Code for pool enclosures
- Compliant with the 2010 ADA Standards for Accessible Design

### Features and benefits

- Patent-pending design built to meet code requirements for pool enclosures
- Weather-resistant components ideal for outdoor applications
- Easy installation and maintenance
- Simple to operate
- UL listed for panic exit hardware (UL305)

### Specifications

Device functions	EO, L, L-BE
Dogging	LD – Less dogging
Device lengths	3', 4'
Center case	8" x 2 3/4" x 2 3/8" (203mm x 70mm x 60mm)
Mechanism case	2 1/4" x 2 1/4" (57mm x 57mm)
Latch bolt	Deadlocking 3/4" (19mm) throw
Trims	252-L, 252-LBE
Strike	699 roller strike
Finishes	626, 710
Options	WH – Weep holes



### Accessories

#### 699 Roller strike



## Trim functions

Von Duprin protects your investment by empowering you to adapt with flexible solutions and modular options. The 98/99 Series features numerous trim options to serve your different needs. Designed with flexibility in mind, our solutions offer ease of adding new options as they are developed.

With Von Duprin, you can be confident that as the needs of your facility change, our products can be upgraded easily to meet your needs, especially as the mechanical and electronic technology converge. Von Duprin’s versatile design enables you to add functionality to existing devices in a cost-effective way, protecting your investment well into the future.

A variety of device trim lock type functions such as key lock and unlock, latch bolt retraction with key and no cylinder designs for an “always operable” function are available in levers, knobs, latches, thumbpiece and thumbturn designs.

	<p><b>EO No outside trim</b></p> <ul style="list-style-type: none"> <li>Exit only</li> </ul>		<p><b>DT Dummy trim</b></p> <ul style="list-style-type: none"> <li>Pull when dogged (not recommended for fire device)</li> </ul>		<p><b>NL Night latch</b></p> <ul style="list-style-type: none"> <li>Key retracts latchbolt</li> <li>Rim and 1 ¼" mortise cylinder</li> </ul>
	<p><b>NLOP Night latch</b></p> <ul style="list-style-type: none"> <li>Key retracts latchbolt, pull required</li> </ul>		<p><b>TP Thumbpiece</b></p> <ul style="list-style-type: none"> <li>Key locks and unlocks</li> <li>Rim and 1 ¼" mortise cylinder</li> </ul>		<p><b>TPBE Thumbpiece, blank escutcheon</b></p> <ul style="list-style-type: none"> <li>Blank escutcheon always operable (no cylinder, use with DT trim)</li> </ul>
	<p><b>L Lever</b> <b>K Knob</b></p> <ul style="list-style-type: none"> <li>Key locks and unlocks</li> <li>Rim and 1 ¼" mortise cylinder</li> <li>Handed, reversible lever</li> <li>Electrified lever operation available</li> </ul>		<p><b>LDT Lever, dummy trim</b> <b>KDT Knob, dummy trim</b></p> <ul style="list-style-type: none"> <li>Pull when dogged</li> </ul>		<p><b>LNL Lever, night latch</b> <b>KNL Knob, night latch</b></p> <ul style="list-style-type: none"> <li>Key retracts latchbolt</li> <li>Rim and 1 ¼" mortise cylinder</li> <li>Handed, reversible lever</li> </ul>
	<p><b>LBE<sup>1</sup> Lever, blank escutcheon</b> <b>KBE Knob, blank escutcheon</b></p> <ul style="list-style-type: none"> <li>Always operable (no cylinder)</li> </ul>		<p><b>TL Turn lever</b></p> <ul style="list-style-type: none"> <li>Key locks and unlocks (use with DT trim)</li> <li>1 ¼" mortise cylinder</li> </ul>		<p><b>TLBE Turn lever, blank escutcheon</b></p> <ul style="list-style-type: none"> <li>Blank escutcheon always operable (no cylinder, use with DT trim)</li> </ul>
	<p><b>TLOP Turn lever, optional pull</b></p>		<p><b>HL Hospital latch</b></p> <ul style="list-style-type: none"> <li>Key locks and unlocks</li> <li>1 ¼" mortise cylinder</li> </ul>		

## Trim options

### No trim



#### Trim description

Nomenclature	EO	110NL-MD 110NL-WD
Trim function	No outside trim	Night latch optional pull
Function description	Exit only	Key retracts latch bolt, optional pull required
ANSI function	01	03

#### Device compatibility

98/99/ XP98/XP99 Rim	■	■
98/99/ XP98/XP99 Rim-F	■	■
98/9927/27-F	■	■
98/9947/47-F	■	■
98/9947WDC/WDC-F	■	■
98/9948/48-F	■	■
98/9949/49-F	■	■
98/9950WDC/50WDC-F	■	■
98/9952†	■	
98/9957/57-F	■	■
98/9975/75-F	■	

#### Dimensions

Escutcheon plate size	—	—
Pull center to center	—	—
Projection	—	—

#### Handing

	—	—
--	---	---

#### Cylinder type

Rim or vertical device	—	Rim
Mortise lock device	—	—

† Default trim is 252L /L-BE. Must be ordered as EO when paired with other trims (ordered separately).

## Trim options

### 996 trim



#### Trim description

Nomenclature	996EO	996L*	996L-NL*	996L-BE*	996L-DT
Trim function	Exit only plate	Lever	Lever-night latch	Lever-blank escutcheon	Lever-dummy trim
Function description	Exit only plate	Key locks and unlocks	Key retracts latch bolt	Always operable, no cylinder	Pull when dogged
ANSI function	01	08	03	14	02

#### Device compatibility

98/99 Rim/Rim-F	■	■	■	■	■
XP98/XP99 Rim/Rim-F	■	■	■	■	■
98/9927/27-F	■	■	■	■	■
98/9947/47-F	■	■	■	■	■
98/9947WDC/WDC-F	■	■	■	■	■
98/9948/48-F	■	■	■	■	■
98/9949/49-F	■	■	■	■	■
98/9950WDC/50WDC-F	■	■	■	■	■
98/9952†	†	†	†	†	†
98/9957/57-F	■	■	■	■	■
98/9975/75-F	■	■	■	■	■

#### Dimensions

Escutcheon plate size	2 3/4" x 10 3/4" x 27/32" (70 x 273 x 21mm)				
Pull center to center	—	—	—	—	—
Projection	—	2 7/8" (73mm)	2 7/8" (73mm)	2 7/8" (73mm)	2 7/8" (73mm)

#### Handing

—	Handed/reversible	Handed/reversible	Handed/reversible	Handed/reversible
---	-------------------	-------------------	-------------------	-------------------

#### Cylinder type

Rim or vertical device	—	Rim	Rim	—	—
Mortise lock device	—	1 1/4" mortise	1 1/4" mortise	—	—

\* Specify R/V if used for rim and vertical devices, M for mortise device. Example, 996L-R/V or 996L-M.

† Default trim is 252L /L-BE. Must be ordered as EO when paired with other trims (ordered separately).



## Trim options

## 996 trim

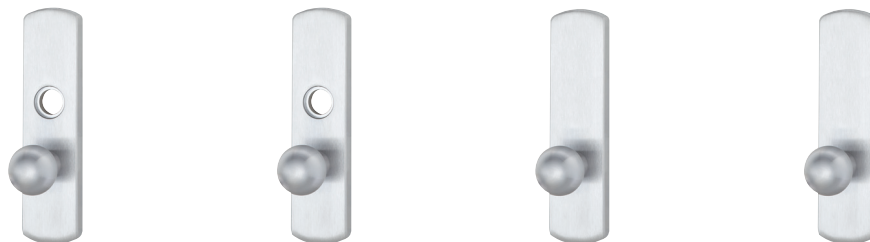

## Trim description

Nomenclature	996K*	996K-NL*	996K-BE*	996K-DT
Trim function	Knob	Knob-night latch	Knob- blank escutcheon	Knob - dummy trim
Function description	Key locks and unlocks	Key retracts latch bolt	Always operable, no cylinder	Pull when dogged
ANSI function	08	03	14	02

## Device compatibility

98/99/ XP98/XP99 Rim	■	■	■	■
98/99/ XP98/XP99 Rim-F	■	■	■	■
98/9927/27-F	■	■	■	■
98/9947/47-F	■	■	■	■
98/9947WDC/WDC-F	■	■	■	■
98/9948/48-F	■	■	■	■
98/9949/49-F	■	■	■	■
98/9950WDC/50WDC-F	■	■	■	■
98/9952†				
98/9957/57-F	■	■	■	■
98/9975/75-F	■	■	■	■

## Dimensions

Escutcheon plate size	2 3/4" x 10 3/4" x 27/32" (70 x 273 x 21mm)			
Pull center to center	—	—	—	—
Projection	3 1/4" (83mm)	3 1/4" (83mm)	3 1/4" (83mm)	3 1/4" (83mm)

## Handing

	—	—	—	—
--	---	---	---	---

## Cylinder type

Rim or vertical device	Rim	Rim	—	—
Mortise lock device	1 1/4" mortise	1 1/4" mortise	—	—

\* Specify R/V if used for rim and vertical devices, M for mortise device. Example, 996K-R/V or 996K-M.

† Default trim is 252L /L-BE. Must be ordered as EO when paired with other trims (ordered separately).

## Trim options

### 990 trim



#### Trim description

Nomenclature	990EO	990DT	990NL*	990TP*	990TP-BE*
Trim function	Exit only plate	Dummy trim	Night latch	Thumbpiece	Thumbpiece blank escutcheon
Function description	Exit only plate	Pull when dogged	Key retracts latch bolt	Key locks and unlocks	Always operable, no cylinder
ANSI function	01	02	03	05	15

#### Device compatibility

98/99 Rim/Rim-F	■	■	■	■	■
XP98/XP99 Rim/Rim-F	■	■	■	■	■
98/9927/27-F	■	■	■	■	■
98/9947/47-F	■	■	■	■	■
98/9947WDC/WDC-F	■	■	■	■	■
98/9948/48-F	■	■	■	■	■
98/9949/49-F	■	■	■	■	■
98/9950WDC/50WDC-F	■	■	■	■	■
98/9952†					
98/9957/57-F	■	■	■	■	■
98/9975/75-F	■	■	■	■	■

#### Dimensions

Escutcheon plate size	3" x 14 <sup>3</sup> / <sub>16</sub> " x <sup>3</sup> / <sub>32</sub> " (76 x 360 x 2mm)				
Pull center to center	—	5 1/2" (140mm)	5 1/2" (140mm)	5 1/2" (140mm)	5 1/2" (140mm)
Projection	—	2" (51mm)	2" (51mm)	2" (51mm)	2" (51mm)

#### Handing

—	—	—	—	—
---	---	---	---	---

#### Cylinder type

Rim or vertical device	—	—	Rim	Rim	—
Mortise lock device	—	—	1 1/4" mortise	1 1/4" mortise	—

\* Specify R/V if used for rim and vertical devices, M for mortise device. Example, 990NL-R/V or 990NL-M.

† Default trim is 252L /L-BE. Must be ordered as EO when paired with other trims (ordered separately).

## Trim options

### 696 trim



#### Trim description

Nomenclature	696DT	696NL*	696TP*	696TP-BE*
Trim function	Dummy trim	Night latch	Thumbpiece	Thumbpiece blank escutcheon
Function description	Pull when dogged	Key retracts latch bolt	Key locks and unlocks	Always operable, no cylinder
ANSI function	02	03	05	15

#### Device compatibility

98/99/ XP98/XP99 Rim	■	■	■	■
98/99/ XP98/XP99 Rim-F	■	■	■	■
98/9927/27-F	■	■	■	■
98/9947/47-F	■	■	■	■
98/9947WDC/WDC-F	■	■	■	■
98/9948/48-F	■	■	■	■
98/9949/49-F	■	■	■	■
98/9950WDC/50WDC-F	■	■	■	■
98/9952†				
98/9957/57-F	■	■	■	■
98/9975/75-F	■	■	■	■

#### Dimensions

Escutcheon plate size	— 1 5/8" x 1 1/2" x 3/16" (41 x 34 x 5mm) —			
Pull center to center	5 1/2" (140mm)	5 1/2" (140mm)	5 1/2" (140mm)	5 1/2" (140mm)
Projection	2 1/6" (52mm)	2 1/6" (52mm)	2 1/6" (52mm)	2 1/6" (52mm)

#### Handing

	—	—	—	—
--	---	---	---	---

#### Cylinder type

Rim or vertical device	—	Rim	Rim	—
Mortise lock device	—	1 1/4" mortise	1 1/4" mortise	—

\* Specify R/V if used for rim and vertical devices, M for mortise device. Example, 696NL-R/V or 696NL-M.

† Default trim is 252L /L-BE. Must be ordered as EO when paired with other trims (ordered separately).

## Trim options

### 697 trim



#### Trim description

Nomenclature	697DT	697NL*	697TP*	697TP-BE*
Trim function	Dummy trim	Night latch	Thumbpiece	Thumbpiece blank escutcheon
Function description	Pull when dogged	Key retracts latch bolt	Key locks and unlocks	Always operable, no cylinder
ANSI function	02	03	05	15

#### Device compatibility

98/99 Rim/Rim-F	■	■	■	■
XP98/XP99 Rim/Rim-F	■	■	■	■
98/9927/27-F	■	■	■	■
98/9947/47-F	■	■	■	■
98/9947WDC/WDC-F	■	■	■	■
98/9948/48-F	■	■	■	■
98/9949/49-F	■	■	■	■
98/9950WDC/50WDC-F	■	■	■	■
98/9952†				
98/9957/57-F	■	■	■	■
98/9975/75-F	■	■	■	■

#### Dimensions

Escutcheon plate size	1 5/8" x 13 1/2" x 3/16" (41 x 343 x 5mm)			
Pull center to center	5 1/2" (140mm)	5 1/2" (140mm)	5 1/2" (140mm)	5 1/2" (140mm)
Projection	3" (76mm)	3" (76mm)	3" (76mm)	3" (76mm)

#### Handing

	—	—	—	—
--	---	---	---	---

#### Cylinder type

Rim or vertical device	—	Rim	Rim	—
Mortise lock device	—	1 1/4" mortise	1 1/4" mortise	—

\* Specify R/V if used for rim and vertical devices, M for mortise device. Example, 697NL-R/V or 697NL-M.

† Default trim is 252L /L-BE. Must be ordered as EO when paired with other trims (ordered separately).

## Trim options

### 374 Control x DT and 376 Control x DT trim



Trim description	374 Control x DT			376 Control x DT		
	374T x 990DT	374T-BE x 990DT	374T-NL x 990DT	376T x 990DT	376T-BE x 990DT	376T-NL x 990DT
Nomenclature	374T x 990DT	374T-BE x 990DT	374T-NL x 990DT	376T x 990DT	376T-BE x 990DT	376T-NL x 990DT
Trim function	Thumbturn	Thumbturn - blank escutcheon	Thumbturn - night latch	Thumbturn	Thumbturn - blank escutcheon	Thumbturn - night latch
Function description	Key locks and unlocks, use with DT trim	Always operable, no cylinder, use with DT trim	Insert key to unlock, remove key to lock	Key locks and unlocks, use with DT trim	Always operable, no cylinder, use with DT trim	Insert key to unlock, remove key to lock
ANSI function	11	16	12	11	16	12
<b>Device compatibility</b>						
98/99/ XP98/XP99 Rim						
98/99/ XP98/XP99 Rim-F						
98/9927/27-F	■	■	■			
98/9947/47-F				■	■	■
98/9947WDC/WDC-F						
98/9948/48-F				■	■	■
98/9949/49-F						
98/9950WDC/50WDC-F						
98/9952†						
98/9957/57-F	■	■	■			
98/9975/75-F						
<b>Dimensions</b>						
Escutcheon plate size				TL: 1 11/16" x 7 1/2" x 7/8" (43 x 191 x 22mm)		
				DT: 3" x 14 3/16" x 3/32" (76 x 360 x 2mm)		
Pull center to center	—	—	—	—	—	—
Projection	2" (51mm)	2" (51mm)	2" (51mm)	2" (51mm)	2" (51mm)	2" (51mm)
<b>Handing</b>						
	—	—	—	—	—	—
<b>Cylinder type</b>						
Rim or vertical device	1 1/4" mortise	—	1 1/4" mortise	1 1/4" mortise	—	1 1/4" mortise
Mortise lock device	—	—	—	—	—	—

† Default trim is 252L /L-BE. Must be ordered as EO when paired with other trims (ordered separately).

## Trim options

### 376 T-WDC Control x DT and 252 trim



Trim description	376 T-WDC Control x DT			252 Trim	
Nomenclature	376T-WDC x 990DT	376TWDC-BE x 990DT	376TWDC-NL x 990DT	252L	252L-BE
Trim function	Thumbturn	Thumbturn - blank escutcheon	Thumbturn - night latch	Lever	Lever - blank escutcheon
Function description	Key locks and unlocks, use with DT trim	Always operable, no cylinder, use with DT trim	Insert key to unlock, remove key to lock	Key locks and unlocks	Always operable, no cylinder
ANSI function	11 or 12	16	04	08	14
<b>Device compatibility</b>					
98/99 Rim/Rim-F					
XP98/XP99 Rim/Rim-F					
98/9927/27-F					
98/9947/47-F					
98/9947WDC/WDC-F ■ ■ ■					
98/9948/48-F					
98/9949/49-F					
98/9950WDC/50WDC-F					
98/9952† ■ ■					
98/9957/57-F					
98/9975/75-F					
<b>Dimensions</b>					
Escutcheon plate size	TL: 1 <sup>11</sup> / <sub>16</sub> " x 7 <sup>1</sup> / <sub>2</sub> " x 7 <sup>7</sup> / <sub>8</sub> " (43 x 191 x 22mm)			3" x 6 <sup>3</sup> / <sub>8</sub> " x 15 <sup>15</sup> / <sub>16</sub> "	
	DT: 3" x 14 <sup>3</sup> / <sub>16</sub> " x 3 <sup>3</sup> / <sub>32</sub> " (76 x 360 x 2mm)			(76 x 162 x 24mm)	
Pull center to center	—	—	—	Handed/reversible	
Projection	—	2" (51mm)	2" (51mm)	2 <sup>5</sup> / <sub>8</sub> " (67mm)	2 <sup>5</sup> / <sub>8</sub> " (67mm)
<b>Handing</b>					
—					
<b>Cylinder type</b>					
Rim or vertical device	1 <sup>1</sup> / <sub>4</sub> " mortise	—	1 <sup>1</sup> / <sub>4</sub> " mortise	1 <sup>1</sup> / <sub>4</sub> " mortise	—
Mortise lock device	—	—	—	—	—

† Default trim is 252L /L-BE. Must be ordered as EO when paired with other trims (ordered separately).

## Optional trim

### Schlage® HL6 quiet hospital push/pull latch

Von Duprin and Schlage® have collaborated on an exit device trim that provides both accessibility and performance. In combination, the 98/9975 mortise lock device along with the newly designed Schlage HL6 quiet hospital push/pull latch delivers an exit device with mortise lock durability that utilizes an easy to use, ADA compliant push/pull trim. The HL6 is now 50% quieter through dampened paddle action, reducing the noise associated with lock operation providing healthcare organizations a reliable solution for noise reduction initiatives. The 98/9975HL device is available in most standard architectural finishes, including antimicrobial options. Consult the HL Series [catalog](#) or [data sheet](#) for complete product information.



### 392-7 Offset pull

The 392-7 Offset pull is 3/4" round stainless steel, with a 7" center to center which matches the 98/99 center case. Often used with a night latch operation. 3 1/2" (89mm) offset with 1 1/2" (38mm) clearance.



### Vandal resistant trim: Ives VR910 and VR914 Series

VR910 black grip for softer touch and resilience to temperature extremes. VR914 grip in all stainless steel. Grip designed for comfortable operation.



#### Features:

- Stainless steel construction, 11 gauge (0.120" thick); 630 finish only
- Thru-bolts and rugged mounting screws for maximum fastening strength
- Built-in lock protector prevents vandalism to mortise latch bolt (available on certain models)
- Extra-tough stainless steel cylinder collar prevents pipe wrench or similar tool from damaging cylinder; tapered design prevents side impacts from transferring directly to cylinder; collar spins freely.
- Furnished with mounting screws for door thicknesses of 1 3/4" to 2 1/4"
- 1 1/2" (38mm) clearance from grip to door, total projection 1 7/8" (48mm)
- Consult the Ives catalog for more information

Model	For use with	Size
VR910DT and VR914DT	98/99 Rim or vertical rod device	5 1/2" x 11" (133mm x 279mm)
VR910NL and VR914NL	98/99 Rim or vertical rod device	5 1/2" x 11" (133mm x 279mm)
VR910M-DT and VR914M-DT	9875/9975 Mortise device	7 1/4" x 11" (184mm x 279mm)
VR910M-NL and VR914M-NL	9875/9975 Mortise device (handing required)	7 1/4" x 11" (184mm x 279mm)

# Electronic locks from Schlage

## AD Series

The AD Series was designed to be the right choice for today, and is ready to adapt to whatever the future holds.

There are a variety of options that allow you to select the AD Series electronic lock that's right for you, and a wide selection of features that can be configured in the field to further customize each opening. When your needs change in the future, the innovative modular design of the AD Series allows you to easily upgrade the credential reader or networking option, and adapt to emerging technologies using your existing chassis – all without taking the lock off the door. This means that you can be confident that your choice of the AD Series is right for today, and that your investment will be protected into the future.



### Credential reader options

AD Series electronic locks are compatible with many different credential types.



- Multi-technology (reads 125 kHz prox and 13.56 MHz smart)
- Smart - iClass compatible  
+ KEYPAD
- Magnetic stripe (insertion)  
+ KEYPAD
- Magnetic stripe (swipe)  
+ KEYPAD
- Keypad

### Communication options

#### Networked

In facilities where increased monitoring and control are needed, a networked solution is essential. The AD Series networked options feature:

- Open architecture platform
- Reliable 900 MHz communication on wireless locks
- Real-time monitoring

The AD Series networked lock is available in either a wireless or hardwired configuration to fit your application needs.

- **AD-300** Networked hardwired locks
- **AD-302** Networked hardwired FIPS 201-2 integration-ready locks
- **AD-400** Networked wireless locks
- **AD-402** Networked wireless FIPS 201-2 integration-ready locks

### Standalone

Standalone locks are a cost-effective solution for doors that do not require real-time monitoring.

The AD Series standalone solution provides:

- Option for future upgrade to networked wireless
- Improved credential management
- Audit trail reports

Schlage offers two AD Series standalone solutions to fit your environment:

- **AD-200** Access rights are stored on the lock
- **AD-250** Access rights are stored on the magnetic stripe credential

### Chassis

- Cylindrical
- Mortise
- Mortise deadbolt
- Exit trim<sup>1</sup>

### Locking functions<sup>2</sup>

- Classroom/storeroom
- Office
- Privacy
- Apartment

### Certifications

- ANSI/BMHA A156.25
- ANSI/BHMA Grade 1
- UL 294 listed
- UL 10C
- ADA
- FCC part 15
- RoHS

### Complete your system

Complete your AD Series system with readers, credentials, system components, and other wireless accessories.

1. See AD Series exit trim compatibility data sheet for complete list of compatibility by manufacturer.
2. Lock function capability varies depending on Physical Access Control Software (PACS) OEM integration design.

## CO Series

In the world of standalone electronic locks, CO Series offers simple solutions for access control. These easy-to-use, versatile locks can be applied anywhere there is a need to control access without distributing keys. The popular CO-100 is a simple lock that momentarily unlocks with a valid PIN code entry. It can be used indoors or out and allows administrators a variety of command options. The Series also includes CO-200, the CO-220 classroom lock, and the CO-250. These computer programmable locks can provide audit trails and feature dual credential options (card+PIN) that provide an even greater level of security.



### Compatibility

The CO Series offers a wide range of applications and can be used alongside other Schlage electronic locks. They feature expanded cylinder, exit device, and credential compatibility.



## Trim options

# Electronic locks from Schlage

### Exit device compatibility<sup>1</sup>

	Rim	SVR <sup>2</sup>	CVR/CVC	Mortise
Von Duprin 98/99 and 98/99 XP	✓	✓	✓	✓
Von Duprin 22/22F	✓	✓		
Falcon 25	✓			

1. See CO Series exit trim compatibility datasheet for complete list of compatibility by manufacturer.
  2. CO-220 is not compatible with surface vertical rod (SVR) devices.
- Note: Exit device must be ordered as Exit Only (EO).

### Credential compatibility

The CO Series is compatible with many different credential types. For customers with an installed base of iButtons®, a combo proximity keyfob with iButton option is available to make an easy transition to proximity technology.

### Class

#### CO-100

- Manually programmable
- Keypad only
- User rights stored on the lock
- Remote release, outdoor use and occupancy indication options

#### CO-200

- Computer or manually programmable
- Keypad, magnetic stripe (+PIN), proximity (+PIN)
- User rights stored on the lock
- Ability to provide schedules and audits

#### CO-220

- Computer or manually programmable
- Keypad, magnetic stripe (+PIN), proximity (+PIN)
- User rights stored on the lock
- Ability to provide schedules and audits
- Classroom lockdown function via fob

#### CO-250

- Computer programmable
- User rights stored on the card

### Chassis

- Cylindrical
- Mortise
- Mortise deadbolt
- Exit trim

### Functions

- Classroom/storeroom
- Office
- Privacy

### Power

- 4 standard (AA) batteries

### Reliability

When it comes to securing your facility, you can't afford to take chances. CO Series locks are tested to the highest quality and reliability standards in the industry, including:

- ANSI/BHMA A156.25 and ANSI/BHMA Grade 1
- UL 294
- UL 10C
- ADA

## Lever styles and finishes for AD and CO Series

### Lever options

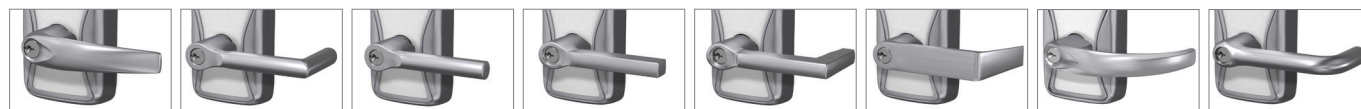

Athens

Boardwalk

Broadway

Latitude

Longitude

Rhodes

Sparta

Tubular

### Finish options

Color	Bright brass	Satin brass	Satin bronze	Satin nickel	Bright chrome	Satin chrome	Aged bronze
ANSI/BHMA number	605	606	612	619	625	626/626AM	643e

## Dogging options

### Cylinder dogging (CD)

Cylinder dogging is available on all 98/99



Panic exit devices to replace the standard hex key dogging. Unit requires a standard 1 1/4" (32mm) mortise cylinder with an inverted straight cam. When ordering, reference Schlage cylinder 20-001, 1 1/4", XQ11-949. This provides the L583-477 cam inverted at the factory.

**To order, specify:** Use prefix, CD, example CD99L

### Less dogging (LD)

Less dogging is available in all 98/99 Panic exit devices to remove the dogging option.

**To order, specify:** Use prefix LD, example LD99L

### Special center case dogging (SD)

Special cylinder dogging in the center case is available for Chexit, EL, QEL, ALK panic devices to allow for mechanical push/pull operation. With this option, the latch bolt is held retracted and pushbar is still operable. Specify handing—RHR or LHR.

SD requires 1 1/4" (32mm) mortise cylinder with an inverted straight cam. When ordering, reference Schlage cylinder 20-001, 1 1/4", XQ11-949. This provides the L583-477 cam inverted at the factory.

Note: Available on rim and vertical rod panic exit devices only.

**To order, specify:**

1. Prefix SD, example SD99L and Handing.
2. Not for 98/9975 Devices.

### Cylinder dogging kit\* (CDK)

For field conversion, from hex key dogging, conversion kit is available.

**To order, specify:** 99CDK or 98CDK, specify finish.

\*Cannot be added to fire exit hardware.

### Hex key dogging kit\* (HDK)

For field conversion, from cylinder dogging, conversion kit is available.



**To order, specify:** 99HDK or 98HDK, specify finish.

\*Cannot be added to fire exit hardware.

### Dog keys

**Dog key (old style)**

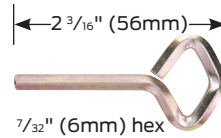

**Dog key (standard)**

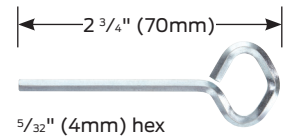

### Dogging indicator (CI/DI)

- Red indicator light every 5 seconds, visible from over 75 feet away
- Available in a hex or cylinder dogging format
- Designed for battery life over one year
- Available as a factory option or field retrofit kit
- Designed for device with mechanical dogging built after 1997

**To order, specify:**

As device option:

1. DI99EO 3' 630 (hex dogging)
2. CDI98EO 4' 628 (cylinder dogging)

As retrofit kit:

1. DI Retrofit Kit 3' 662 (hex dogging)
2. CDI Retrofit Kit 4' 613 (cylinder dogging)

## Classroom security/security indicators

Designed for high use and abuse institution environments, such as schools and hospitals, these Von Duprin products are recommended for the following applications:

### Visual verification

Reduce the time it takes to tour your facility and ensure each door is secure by installing the Von Duprin security indicator to provide at-a-glance visual verification.

### Lockdown

Lock down high occupancy areas such as auditoriums, cafeterias and gymnasiums, from inside the room with the Von Duprin security indicator that provides positive visual confirmation.

### Features and benefits

- Lockdown solution that meets fire and life safety codes for free egress
- Modular conversion kits allow you to quickly and easily upgrade your existing devices

-2SI security indicator with double cylinder

- Thumbturn or key cylinder with lock/unlock labels provide a clear direction of rotation to secure opening
- Available for 98/99 Series rim devices

CDSI/HDSI dogging indicator

- Hex or cylinder dogging options
- Visual indication of whether the exit device is dogged or undogged
- Available for 98/99 & 33A/35A Series panic devices

### Double cylinder with security indicator (-2SI)

The -2SI Security Indicator provides an at-a-glance verification of the LOCKED/UNLOCKED status of the door from inside of the room. This option can be ordered as a new product or as a retrofit conversion kit to an existing 98/99 rim device. Indicator in "UNLOCKED" state presents a 1/2" x 1/2" metal flag (unlock icon, laser cut into flag) at top of device head. Indicator in "LOCKED" state has no flag present.



### To order, specify:

1. Suffix: -2SI double cylinder with security indicator.
2. Available with L, TP or K functions. Specify handing. Rim cylinder (3126) sold separately. Rim cylinder T-turn available from Schlage, order part number XB 11-979.

### Dogging security indicators (CDSI/HDSI)

The CDSI/HDSI dogging indicator provides an at-a-glance verification of the status of the door from inside of the room. Visible "LOCKED" and "UNLOCKED" indicators



show whether the device is undogged or dogged. This feature can be used with hex key (HDSI) or cylinder dogging (CDSI) options on various device types—rim, mortise and vertical systems.

### To order, specify:

1. Cylinder dogging security indicator: Prefix CDSI.
2. Hex dogging security indicator: Prefix HDSI.
3. Above options cannot be used with fire-rated devices and are recommended for use in combination with the following trim functions - DT, K-DT, L-DT, EO, NL, K-NL, L-NL, NL-OP.

### Double cylinder

Double cylinder features an inside key cylinder which locks or unlocks the outside trim and an outside key cylinder which retracts the latch bolt only (Night latch function). Available on rim or mortise lock device.



Rim requires two rim type cylinders. Mortise device requires 1 rim cylinder and 1 mortise cylinder 1 1/4" with a straight cam. (Schlage cam reference L583-477.) Available functions are thumbpiece, knob or lever.

### To order, specify:

1. Suffix -2 with device/trim number, example 99TP-2.
2. Handing required, LHR or RHR.

## Environmental options

### Quiet Mechanical (QM)

The QM option controls motion to reduce operational noise. It is available for the 996 trim, as well as 98/99 and 33A/35A rim and surface vertical rod devices. The QM trim solution provides a damper-controlled lever return. Likewise, the QM rim device option provides damper-controlled re-latching.

#### Features and benefits

- Controlled motion to reduce operational noise
- 996 damper-controlled lever return
- 98/99 and 33/35A damper controlled re-latching
- Available pre-installed from factory or as a retrofit kit
- Compatible with QEL, AX, RX, CD and HD

### Pneumatic (PN) controlled exit devices



The PN feature provides remote latch bolt retraction in hazardous areas where electrically operated devices would not be permitted. The pneumatic solenoid will retract the latch bolt for momentary or prolonged periods. PN exit devices are particularly suited for use with automatic door operators. The PN feature is available on both Panic and fire exit hardware devices.

The PN feature includes a special actuating linkage that gives building owners the option of mechanically or pneumatically dogging the exit device. If manual hex-key dogging is required, specify HD-PN (Dogging the device, whether mechanically or pneumatically, makes the device function as a push/pull unit and reduces the wear on its moving parts.) If cylinder dogging is required, the standard cylinder dogging is not available, but special center case dogging is available, specify SD-PN. SD-PN is not available on the 9875 or 9975 devices.

When activated pneumatically, the latch bolt(s) of the exit device retract in 1/2 to 1 1/2 seconds. This pneumatic operation uses air pressure ranging from 50 to 100 pounds per square inch.

This product will function only when it is part of a pneumatic system (air compressor, air lines, pneumatic system, etc.) Contact LCN for correct control boxes.

#### To order, specify:

- Standard — Use prefix PN, example PN99NL
- Hex key dogging — Use prefix HD-PN, example HD-PN99NL
- Special center case dogging (handing is required, specify RHR or LHR) — Use prefix SD-PN, example SD-PN99NL

### Pneumatic transfer (PNT)

#### Pneumatic controls

PNT-1 is available for pneumatic latch retraction exit devices. Appearance and dimensions are identical to EPT models.

## Mechanical options

### Weatherized options

#### Windstorm (WS) surface vertical rod one-point and three-point exit devices

WS Multi-point exit devices for tornado application devices WS98/9927 (two-point) and WS98/9957 (three-point) surface vertical rod exit devices are designed, tested and certified to comply with the Federal Emergency Management Agency's publication FEMA 361- Design and Construction Guidance for Community Safe Rooms.

#### Features and benefits

- Uniquely designed center case
- Vertical rods designed to reinforce the strength of the door
- Reinforced top and bottom latch housing with strengthening strap
- Stamped end cap mounting bracket
- Top soffit latch with reinforced ratchet release bracket
- Cast latch covers
- Stronger latch mounting screws
- Thru-bolted attachment points

#### UL Listing – panic hardware UL 305; and fire exit hardware UL 10C:

##### WS98/9927:

3 hour pairs of doors double egress, 90 minutes swinging same direction, 8'0" x 8'0" BHMA Grade 1, ANSI A156.3-2001

##### WS98/9957:

3 hours single doors, 4'0" x 8'0" BHMA Grade 1, ANSI A156.3-2001

#### Windstorm ratings:

##### WS98/9927:

- Door applications 8'0" x 8'0" (2438mm x 2438mm) pairs (swinging same direction); 4'0" x 8'0" (1219mm x 2438mm) single (non-fire rated only) flush hollow metal
- Florida Building Code Compliance Compliance to TAS 201, TAS 202, TAS 203; design load rating +150/-150 PSF (245 mph wind zone); Enhanced Hurricane Protection (EHPA) ASTM E1996; ANSI/ICC 500 (245 mph wind zone)
- UL-FEMA 361 Compliance to TAS 201, TAS 202, TAS 203; design load rating +150/-150 PSF (245 mph wind zone); Enhanced Hurricane Protection (EHPA) ASTM E1996; ANSI/ICC 500 (245 mph wind zone)

##### WS98/9957:

- Door applications 4'0" x 8'0" (1219mm x 2438mm) single (panic and fire rated) flush hollow metal
- UL-FEMA 361 Certified 4'0" x 8'0" (1219mm x 2438mm) single (panic and fire rated) flush hollow metal

- These devices are listed with Steelcraft Paladin™ Doors for tornado listing and Steelcraft H and HE Series doors for hurricane listings

**To order, specify:** WS prefix, example WS9927-F

Specifications	
Device functions	Device ships EO (exit only). For TP (Thumbturn), K (Knob), or L (Lever). Remove NL drive screw from device
Device lengths	3': 2'4" to 3' (71mm to 914mm) door size 4': 2'10" to 4' (864mm to 1219mm) door size
Strikes	Bottom – 304L Unfinished
Dogging feature	Hex key dogging standard (Panic)
Dogging options	CD Cylinder dogging LD Less dogging
Electrical options	LX Latch bolt monitor switch RX Request to exit RX-2 Double request to exit ALK Alarm exit kit SS Signal switch QEL Quiet electric latch
Fasteners and sex bolts (SNB)	Includes 1 3/4" (44mm) metal doors SNB furnished for top and bottom latches and device (required)
Device centerline from finished floor	39 1/2" (1003mm)
Door undercut	1/4" (7mm)
Center case dimensions	8" x 2 3/4" x 2 3/8"
Mechanism case dimensions	2 1/4" x 2 1/4" (57mm x 57mm)
Top and bottom latch case	4 1/2" x 2 1/2" x 1 7/8" (114mm x 64mm x 48mm)
Vertical rods	1/2" (13mm) round tubing, standard rods accommodate 7' (2134mm) door  Top rod length is 36 1/4" (921mm) Bottom rod length is 31 3/4" (806mm)
Projection	Pushbar neutral – 3 13/16" (97mm) Pushbar depressed – 3 1/16" (78mm)
Finishes	605, 606, 612, 625, 626, 628, 710, 711 and 630* *630 available on WS9827 and WS9857 devices only

#### Weep holes (WH)

WH is available for all 98/99 Series exit devices. Weep holes are ideal for devices that are mounted to exterior doors that can be exposed to rain and other elements. Hole spacing on 3' and 4' devices are every 6" on center. A 3 foot device will have 5 holes, a 4 foot device will have 7 holes.

**To order, specify:** Suffix WH, 99EO-WH.

## Accessibility options

### Accessible device (AX)

The AX device is a UL certified exit device designed to meet the progressive requirements of the California Building Code for accessible openings. This device meets the 5 lbs of operating force requirement called for in chapter 11B-309.4. The AX device also exceeds ANSI/BHMA requirements. Available devices include: AX98/99, AX98/99-F, AX98/9927LBR, AX98/9927-F LBR, AX98/9949LBL, AX98/9949-FLBL, AX98/9949-F LBLAFL, AX98/9950LBL, AX98/9950-FLBL. Additionally, all AX devices will be shipped with a new UL label clearly stating "Meets California building Code (2013) Sec. 11B-309.4" and an "AX" identifier label on device center case. See images below for reference.

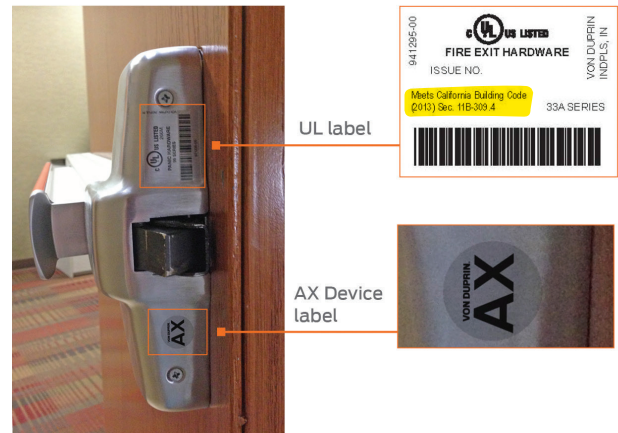

## Latches

### Less bottom rod, panic and fire rated (LBR)

LBR option is available, using a spring loaded auxiliary latch bolt installed in the lower door edge. When exposed to heat the auxiliary latch bolt releases, keeping the doors in alignment and closed during a fire. UL listed 3 hours on hollow metal doors double egress, 90 minute swinging same direction, and 20 minutes wood doors (consult wood door manufacturer). Fits door stiles as narrow as 3 5/8".

LBR devices must be ordered in pairs or must be used in conjunction with an approved automatic or constant latching flush bolt.

### Pullman latch (PL)

When PL is specified the standard latches are replaced with pullman style latches. Pullman latches are always extended and are most commonly used in conjunction with electric strikes and LBR-less bottom rod application. Not available with Fire rated devices.

Not recommended where security is of the utmost importance since latches do not deadlock.

## Mechanical options

### Push pads

#### Dummy push pad



The 330 dummy push pad is designed as a companion unit for all 99 devices. The 350 dummy push pad is a companion unit for all 98 devices. The push pad is rigid or nonfunctioning. A push/pull operation can be accomplished by using 990DT, 996DT trim or any Ives Pull.

The 330/350 can be equipped with a functional push pad and will accommodate an RX or WP-RX switch. Specify RX-330.

May also be equipped with the RX2, double RX switch.

#### To order, specify:

1. 330 or 350.
2. Size 3' or 4' (914mm or 1219mm)
3. Finish – 605, 606, 612, 625, 626, 628, 710 and 622/711. (630 – 350 only)
4. Specify RX, WP-RX or RX-2 if desired.

#### Safety glow (SG)



Self-illuminating touchpad defines the location of the exit door in dark or smoke-filled area. The safety glow coating is a special powder coat finish that glows brightly during low or no light conditions. This coating was developed to meet MEA standards where luminescent exit door markings are required in commercial facilities. There are no batteries or electronics, the coating is charged when exposed to light.

**To order, specify:** Suffix SG, EL 9927L-SG

#### Red silk screen (RSS)



Red silkscreen lettering on touchpad trim. - "Emergency Exit Only, Push To Open And Sound Alarm". This comes standard on RSS devices.

**To order, specify:** Suffix RSS, 9927L-RSS RHR

#### Braille, embossed and knurled touchpads



\* Image shown is a special order.

Braille touchpad embossed with the standard message "CAUTION STAIRWELL" in braille and raised letters provides assistance to persons with impaired vision. Letters are 1/2" (13mm) high and braille is #2, raised height is 3/32" (2mm). Other messages are available on special order, limited to 20 characters per line.\* **To order, specify:** Suffix BR, EL9927L-BR.

Embossed touchpad is embossed with the word "PUSH". **To order, specify:** Suffix EMB, EL9927L-EMB.

Knurled touchpad is to provide warning to persons with impaired vision. **To order, specify:** Suffix PBKN, EL9927L-PBKN.

\*Consult factory for availability.

## Latch retraction

### Quiet electric latch retraction (QEL)

Quiet electric latch retraction (QEL) provides electronic control of an exit device for environments where limited operational noise is desired. These devices always provide mechanical egress. The electrified latch retraction can also be activated by an access system or building automation system to unlatch the exit device momentarily. Often the QEL is used with a credential reader and access control system to unlock the door momentarily for authorized users.

The QEL can also be configured to electronically retract the latch for an extended period of time to allow free entry. This is a convenient alternative to mechanical dogging. If manual dogging is required, the hex dogging option is available, to order specify HD-QEL. Special center case dogging is also available for 98/99 rim and vertical systems, specify SD-QEL.

The QEL option is available on panic devices and fire rated devices. UL approved for Class II circuit applications.

The QEL option does not include the power transfer from door to frame, the power supply, or the control operator. Refer to EPT-2 power transfer and the PS902 or 914 power supply.

The PS902/914 with the 2RS, 4RL or 4R board is the minimum required. Other option boards available for other functions, see PS902/914 power supply for additional information.

The QEL has a low in rush current, so it can be used with standard Schlage power supplies. Calculate the peak current draw of all devices in the system to determine the required amperage of the supply.

The -2RS option board is designed to control two electric latch retraction devices and provide time delay between the firing of outputs is required. The power transfer is also sold separately.

### To order, specify:

1. Standard — use prefix QEL, example QEL99L.
2. Special center case dogging — use prefix SD-QEL, example SD-QEL99L

Note: Baseplate and modular QEL Conversion kits are available for field retrofit. Please see parts/service manual for part numbers.

Schlage PS902	Schlage PS904	Schlage PS906
Up to 2 amps	Up to 4 amps	Up to 6 amps

### QEL Electrical load

Voltage	24VDC
Current	1.0 A Inrush (0.5 sec.) / 0.14 A Holding

### Minimum door opening widths

Application	Surface vertical	Concealed vertical	Mortise	Rim
Min. door opening	28 1/4"	28 1/4"	28 3/4"	29 1/4"

### Popular application

Power supply PS902-2RS  
Electrified power transfer EPT-2 or EPT-10

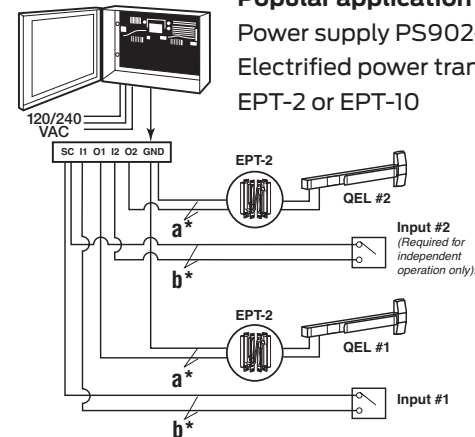

a*	Distance (one-way)	Wire gauge
	200'	18 AWG
	320'	16 AWG
	500'	14 AWG
	800'	12 AWG

b*	Wire selection	Switch wire size
	1200 ft. Max.	18 gauge standard



## Electrified options

### Latch retraction

#### Electric latch retraction (EL)

The Electric latch retraction (EL) option provides electronic control of an exit device using a powerful, continuous duty solenoid. If manual dogging is required, special center case dogging is also available for 98/99 rim and vertical systems, specify SD-EL. SD-EL is not available on 9875 or 9975 devices. UL approved for Class II circuit applications.

The EL option does not include the power transfer from door to frame, the power supply, or the control operator. Refer to EPT-2 power transfer and the PS914 power supply.

The PS914 with the 9002RS option card is the minimum option card required. Other option cards available for other functions, see PS914 power supply for additional information.

<b>Solenoid specifications:</b>	<b>Solenoid resistance:</b>
Continuous duty – 24 VDC	-grn-yel 1.2 – 2.2 OHMS
Current inrush – 16 amps	-grn-org 100 – 150 OHMS
Current holding – 0.3 amps	

#### To order, specify:

1. Standard – Use prefix EL, example EL99L.
2. Hex Key dogging – Use prefix HD-EL, example HD-EL99L.
3. Special center case dogging – Use prefix SD-EL, example SD-EL99L

Note: Baseplate and EL Conversion kits are available for field retrofit. Please see parts/service manual for part numbers.

#### Minimum door opening widths

Application	Surface vertical	Concealed vertical	Mortise	Rim
Min. door opening	28 1/4"	28 1/4"	28 3/4"	29 1/4"

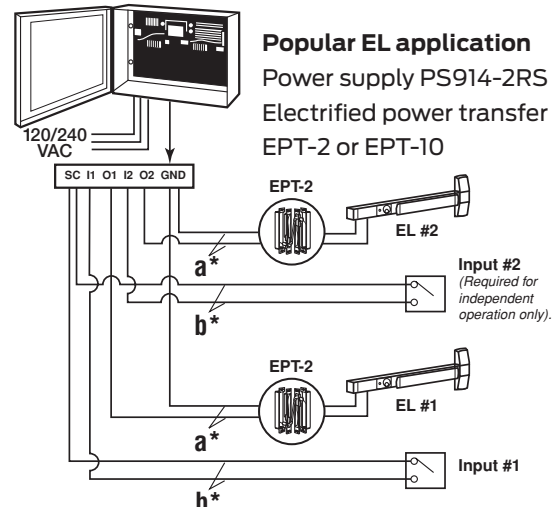

Von Duprin exit device	EL Wire length (feet) <sup>1</sup>	Wire gauge (AWG)
	0-500	12
EL 98/99 Rim	0-300	14
	0-200	16
<b>a*</b> All other 98/99EL device types	0-250	12
	0-150	14
	0-100	16
<b>b*</b> Control switch	0-1200	18

1. Wire lengths include an EPT, Door loop, electric hinge or pivot and are measured one way between the PS914/option board and the device.

Note: Table is applicable to devices that have shipped after August 2012.

## Electrified options

# Delayed egress

### The Chexit® (CX) (with motor driven blocking actuator)\*



The Von Duprin Chexit device is designed for controlled egress applications. It meets both life safety and security needs, as well as the requirements of NFPA 101 for "Special Locking Arrangement" and IBC "Special Egress-Control Devices". All control inputs, auxiliary locking, local alarm and remote signaling outputs are self-contained in the Chexit assembly. Numerous configurable options allow the device to be customized for the specific code or application requirements. The standard Chexit device sounds an alarm and keeps the door secured for 15 seconds following an exit attempt with immediate release upon fire.

The Chexit device includes a 6" x 20" decal for application on door. "PUSH UNTIL ALARM SOUNDS. DOOR CAN BE OPENED IN 15 SECONDS"

#### Chexit typical applications

Chexit single door with options – The Chexit is used as an access control device. The card reader allows access. Also shown in this application is an external horn and door position switch. The auxiliary horn is used for increased volume in remote locations. Using a door position switch gives added security to the opening in case the door is not reclosed.

With the Chexit disarmed, the opening functions as a normal exit device. If card readers are required on both sides of the door, the normally closed contacts of the readers should be wired in series.

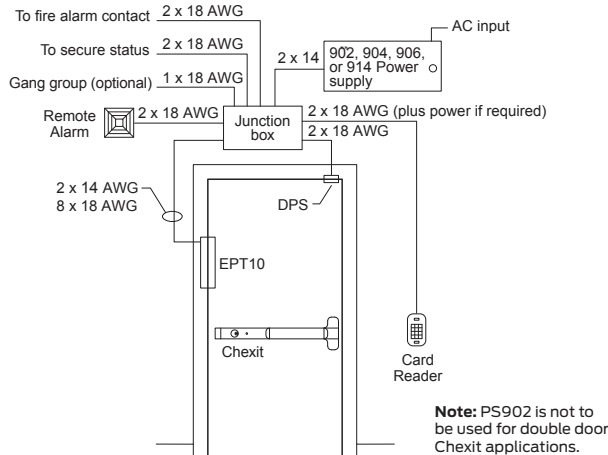

Figure 1. Riser diagram, single door

### Minimum door opening sizes for CX devices

(Consult factory for other size requirements)

Device	3' (914mm) Length	4' (1219mm) Length
CX98/98-F/99/99-F	2'10 3/4" (883mm)	3'4 3/4" (1035mm)
CX-XP98/XP98-F/XP99/XP99-F	2'10 3/4" (883mm)	3'4 3/4" (1035mm)
CX9827/9827-F/9927/9927-F	2'10 1/4" (870mm)	3'4 1/4" (1022mm)
CX9847/9847-F/9947/9947-F	2'10 1/4" (870mm)	3'4 1/4" (1022mm)
CX9848/9848-F/9948/9948-F	2'10 1/4" (870mm)	3'4 1/4" (1022mm)
CX9849/9849-F/9949/9949-F	2'10 1/4" (870mm)	3'4 1/4" (1022mm)
CX9850/9850WDC-F/9950/9950WDC-F	2'10 1/4" (870mm)	3'4 1/4" (1022mm)
CX9857/9857-F/9957/9957-F	2'10 1/4" (870mm)	3'4 1/4" (1022mm)
CX9875/9875-F/9975/9975-F	2'10 1/4" (870mm)	3'4 1/4" (1022mm)

### Specifications / Power supply requirements<sup>1</sup>

Input voltage – 24VDC

Input current inrush – 1.25A

Input current holding – 390mA

Alarm relay and Secure relay contact ratings – 24VDC, 1A

Fire alarm, Inhibit and Door position switch inputs require normally closed dry contacts.

### Power supply information for CX devices with motor driven blocking actuator<sup>1</sup>

Power supply	Maximum number of devices
PS902 (up to 2 amps)	1 Chexit device
PS904 (up to 4 amps)	3 Chexit devices
PS906 (up to 6 amps)	4 Chexit devices
PS914 (up to 4 amps)	4 Chexit devices

Note: When powering multiple components, verify that the amperage requirements of all components combined does not exceed the power supply output rating, see table above for output ratings. Consult Installation Instructions for proper wire gauge and wire run requirements. Exceeding the recommended devices and/or not following Installation Instructions may void your warranty. Call Customer Care at 877-671-7011 or visit the Allegion website for more information - [www.us.allegion.com](http://www.us.allegion.com).

### To order, specify:

1. Prefix product description number "CX".  
Example: CX99L
2. Specify option (see options on page 53).  
Example: CX-RCM or CD-CX
3. Door size other than 3' (914mm).
4. Door thickness other than 1 3/4" (45mm).
5. Finish.
6. Handing, LHR or RHR. Required with "CD" option.

1. Chexit devices built after August 24, 2015 are built using motor driven blocking actuators that have decreased power supply and operating requirements. The information listed in this catalog references the power supply and operating requirements that are needed for the new products with motor driven blocking actuators. For information on devices built previous to August 24, 2015, please contact Customer Care at 877-671-7011.

## Electrified options

# Delayed egress

## Chexit, RCM and DE5300 features

The Chexit, remote chexit module (RCM) or DE5300 devices have several features and options available to fit your applications. See below for more information.

### Inputs and outputs

#### Fire alarm input

This input releases the door immediately upon a fire alarm allowing immediate egress. The internal alarm can be silenced during a fire input via an onboard switch setting.

#### Inhibit input (access control)

This optional input is provided to allow authorized egress or entry when the device is armed using an external card reader, key switch, etc. It also allows remote reset of the Chexit, RCM or DE5300 in an alarmed condition. The ability to reset alarms with the inhibit input can be disabled via an onboard switch setting.

#### Door position switch input

An optional door position switch (DPS) can provide door position status to Chexit, RCM or DE5300 for additional security, ensuring that the door is closed, and can cause alarm when the door is left or forced open.

#### Gang bus

The gang bus allows a Chexit, RCM or DE5300 device to signal other Chexit, RCM or DE5300 devices when it enters the release delay, allowing multiple doors to release at the same time in an emergency. Up to 8 devices may be connected to the gang bus.

#### Alarm relay contacts

The alarm relay contacts are provided as a means to control a remote alarm, such as a horn or lamp, or signal an external monitor. The contacts can be configured with a jumper as normally open or normally closed, and become active upon entering an alarmed condition.

## Secure relay contacts

The secure relay contacts are provided as a means to signal an external monitor. The contacts can be configured as normally open or normally closed with a jumper, and become active when the dps indicates the door is closed and the push pad is locked.

### Delays

#### Release delay

When the push pad is pushed and the nuisance delay expires, the Chexit, RCM or DE5300 enters the release delay with alarm. During the release delay, the internal alarm sounds, the alarm relay activates, and the Chexit/RCM keeps the push pad or DE5300 magnetic lock, locked for 15 seconds (less any time already elapsed during the nuisance delay). Once started, the release delay sequence will not stop and the devices will unlock.

#### Nuisance delay

When a Chexit, RCM or DE5300 is located in a public area, it can be desirable to limit false releases when the push pad is accidentally pushed. The nuisance delay is the brief time a push pad can be accidentally pushed before the release delay sequence starts. If the nuisance time is set to 0 seconds the Chexit, RCM or DE5300 will enter release delay as soon as the push pad is pushed (when armed). Setting the nuisance time to 1, 2, or 3 seconds allows the push pad to be pressed for 1 to 3 seconds before the Chexit, RCM or DE5300 goes into release delay. If the nuisance audio and nuisance delay are both on, the internal alarm will pulse during the nuisance delay. The alarm relay does not activate during the nuisance delay. If the push pad is released before the nuisance delay expires, the Chexit, RCM or DE5300 will remain armed.

## Delayed egress

### Chexit, RCM and DE5300 features (continued)

#### Rearm delay

The rearm delay is the amount of time after the key switch or inhibit input is deactivated to when the device rearms. It is designed to give someone time to pass through the door before rearming occurs. The rearm time can be changed via the onboard switch settings from 0 and 28 seconds in 2 second increments. If the rearm time is set to 30 seconds and a DPS is used, if the door is opened and the rearm time expires, there will be no alarm. The Chexit, RCM or DE5300 will rearm after the door is closed. If the door never opens, the Chexit, RCM or DE5300 will rearm after 30 seconds. If not using a DPS, the Chexit, RCM or DE5300 will always rearm in 30 seconds.

#### DPS delay

If the DPS detects that the door closed during the rearm delay, the Chexit, RCM or DE5300 ends the rearm delay and allows 2 seconds for the latch to clear the strike before rearming.

### Interface

#### Key switch

The Key Switch provides the means to Arm or Disarm/Reset the Chexit, RCM or DE5300. Turning the Key Switch clockwise initiates the Rearm Delay, and turning the Key Switch counter-clockwise Disarms/Resets the Chexit, RCM or DE5300. The Key Switch allows the key to be removed in either the Arm or the Disarm/Reset position.

#### Status indicator

The red Status Indicator displays the status of the Chexit, RCM or DE5300. The Status Indicator flashes slow if the Chexit, RCM or DE5300 is armed, flashes fast in an alarmed mode, is off when inhibited and on solid during Rearm Delay.

#### Internal alarm

The Internal Alarm sounds the status of the Chexit, RCM or DE5300. The Internal Alarm sounds continuously during and after a fire alarm or a Release Delay, pulses fast during the Nuisance Delay or a tamper and pulses slow during Disarmed Powerup mode.

### Settings

#### Armed powerup

When set to OFF, a power disruption and power return will put the Chexit, RCM or DE5300 in a disarmed, unlocked alarm mode.

#### Trim fail safe / fail secure (FS/FSE)

The trim input power can be set to FS (Fail Safe; locked when energized, unlocked when deenergized or during power failure) or FSE (Fail Secure; unlocked when energized, locked when deenergized or during power failure).

The trim must be bought or modified to physically function as FS or FSE. This on board setting only selects the trim input power.

#### Trim operation overview

Rim and vertical application: Trim will not function when Chexit is armed.

Mortise application: Trim will function when Chexit is armed.

### Chexit requiring pull side operation

	Mechanical trim	Electric Trim
Rim and vertical	Access control disarms Chexit. Rotate lever to enter.	Access control disarms Chexit and unlocks electric trim. Rotate lever to enter. <sup>1</sup>
Mortise	a) Use key to unlock lever. Rotate lever to enter. <sup>2</sup> b) Use RX996L-M to disarm Chexit. Rotate lever to enter. <sup>3</sup>	Access control disarms Chexit and unlocks electric trim or electric mortise lock. Rotate lever to enter.

1. Fail Secure Trim recommended. For Fail Safe applications, contact technical support to review application.
2. Do not use Door Position Switch with Chexit in this application.
3. Allows free ingress at all times.

## Electrified options

## Delayed egress

### Remote Chexit Module (RCM)

Designed to provide the concept of the Chexit delayed exit system for door sizes smaller than the standard Chexit device can accommodate. The Chexit module is installed in a control box and mounted in a remote location.



RCM Module

Features and functions of the standard Chexit exit device are available on the Remote Chexit Module.

### Minimum door opening sizes for RCM devices

(Consult factory for other size requirements)

Device	3' (914mm) Length	4' (1219mm) Length
CX-RCM 98/98-F/99/99-F	2'5" (737mm)	2'11" (889mm)
CX-RCM XP98/XP98-F/XP99/XP99-F	2'5" (737mm)	2'11" (889mm)
CX-RCM 9827/9827-F/9927/9927-F	2'4 1/2" (724mm)	2'10 1/2" (876mm)
CX-RCM 9847/9847-F/9947/9947-F	2'4 1/2" (724mm)	2'10 1/2" (876mm)
CX-RCM 9848/9848-F/9948/9948-F	2'4 1/2" (724mm)	2'10 1/2" (876mm)
CX-RCM 9849/9849-F/9949/9949-F	2'4 1/2" (724mm)	2'10 1/2" (876mm)
CX-RCM 9850/9850WDC-F/9950/9950WDC-F	2'4 1/2" (724mm)	2'10 1/2" (876mm)
CX-RCM 9857/9857-F/9957/9957-F	2'4 1/2" (724mm)	2'10 1/2" (876mm)
CX-RCM 9875/9875-F/9975/9975-F	2'5 1/2" (743mm)	2'11 1/2" (902mm)

### Specifications / Power supply requirements\*

Size – 3.75" x 5.57" x 2.50"

Input voltage – 24VDC

Input current inrush – 1.25A

Input current holding – 390mA

Alarm relay and Secure relay contact ratings – 24VDC, 1A

Fire alarm, Inhibit and Door position switch inputs require normally closed dry contacts.

\*RCM modules built after August 24, 2015 are built using motor driven blocking actuators that have decreased power supply and operating requirements.

Note: The information listed in this catalog references the power supply and operating requirements that are needed for the new products with motor driven blocking actuators. For information on devices built previous to August 24, 2015, please contact Customer Care at 877-671-7011.

### Cylinder dogging (CD)

Special center case cylinder dogging option is available to allow push/pull operation of the Chexit, when disarmed and used in a heavy traffic area. Prefix device with "CD" and specify handing.

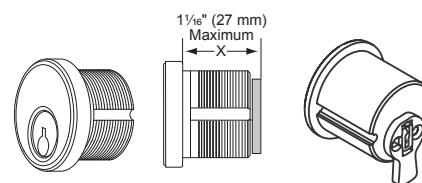

### Cylinders

Cylinders are not furnished with the Chexit device and must be specified when ordering. Use 1 1/4" mortise cylinder with compression ring 36-083 with straight cam and orient cam as shown. Schlage cylinder 20-001-114 recommended for the device and the CD cylinder dogging option. See Schlage Pricebook for additional information.

### To order, specify\*:

See Chexit "How to order" on page 50.

## Delayed egress system

### DE5300 system

Designed for controlled egress applications when used in conjunction with a magnetic lock. It meets both life safety and security needs, as well as the requirements of NFPA for "Special Locking Arrangement" and IBC "Special Egress-Control Devices". All control units,



DE5300 Module

auxiliary locking, local alarm and remote signaling outputs are self-contained in the DE5300 assembly.

The DE5300 is commonly used on narrow stile doors where a standard or narrow stile Chexit is not practical. DE5300 Delayed Exit System uses a Chexit logic board and a Von Duprin RX-LC (low current request to exit) panic device to control a Schlage Electronics Direct Hold Magnetic Lock.

The Chexit module for the DE5300 is installed in a control box and mounted in the wall adjacent to the door. Features and functions of the standard Chexit exit device are available on the DE5300.

The DE5300 device includes a 6" x 20" decal for application on door.

"PUSH UNTIL ALARM SOUNDS.  
DOOR CAN BE OPENED IN 15 SECONDS"

### Cylinders

Cylinders are not furnished with the DE5300 and must be specified when ordering. Use 1 1/4" mortise cylinder with compression ring 36-083 with straight cam and orient cam as shown. Schlage cylinder 20-001-114 recommended for the device and the CD cylinder dogging option. See Schlage Pricebook for additional information.

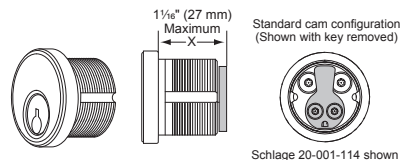

Schlage 20-001-114 shown

### Specifications / Power supply requirements

Size - 3.75" x 5.57" x 2.50"
Input voltage - 24VDC
Input current - 1A
Alarm relay and Secure relay contact ratings - 24VDC, 1A
Fire alarm, Inhibit and Door position switch inputs require normally closed dry contacts.

### To order, specify:

1. DE5300
2. M420/P, M450/P, or M490/P magnetic lock (order direct from Schlage Electronics).
3. RX-LC 22/33A/35A/98/99 device.
4. PS900 Series
5. EPT-2/10

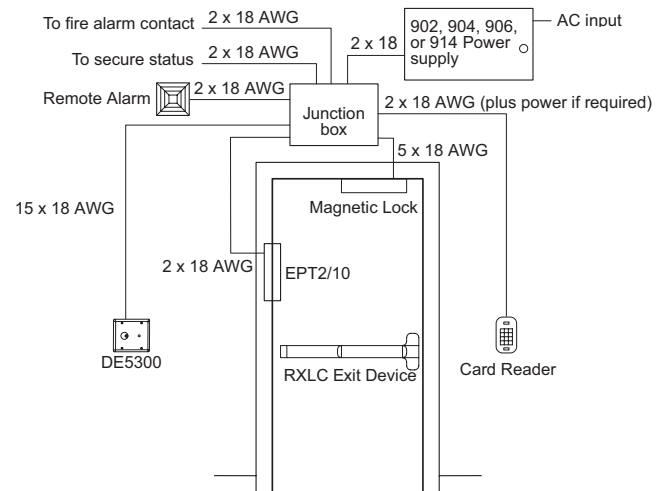

Figure 1. Riser diagram, single door

## Electrified options

### Switches

#### Request to exit (RX)

The RX feature is used to signal the use of an opening. This device is equipped with one internal SPDT switch which monitors the push pad. The device can be connected to a security console, or may be used as a single door alarm when used with a horn and power supply. The RX switch option should not be used to control a load, but as a signalling switch (2 amps resistive maximum). The RX switch is available in a low current (LC) 50ma max. Most commonly used to signal low-current access control inputs.

##### To order, specify:

- Standard – use prefix RX, example RX99EO
- Low Current – use prefix RX-LC, example RX-LC98EO

#### Double request to exit (RX2)

The RX2 feature uses two RX switches.

##### To order, specify:

- Standard – Use prefix RX2, example RX299EO

#### Waterproof request to exit (WP-RX)

- Switch rated to IP67 – protected from contact with harmful dust and from immersion in water with a depth of up to 1 meter (3.3 feet) for up to 30 minutes

Note: All in-field electrical connections should be in compliance with IP67 to ensure trouble free operation.

#### Latch bolt monitoring (LX)

The LX feature is used to signal the use of an opening. This device is equipped with one internal SPDT switch which monitors the latch bolt.

The device can be connected to a security console, or may be used as a single door alarm when used with a horn and power supply.

The LX switch option should not be used to control a load, but as a signalling switch (2 amps resistive maximum).

The LX switch is available in a low current (LC) switch. Most commonly used in computer operated monitoring systems.

##### To order, specify:

- Standard – Use prefix LX, example LX99EO
- Low Current – Use prefix LX-LC, example LX-LC98EO

##### Electrical rating for all switches:

- Standard – 2 amp maximum @ 24VDC
- Low Current (LC) - below 50 Milliamps @ 24VDC

Note: All switches can be either factory or field installed

#### Signal switch (SS)



Monitors push pad and latch bolt. The SS feature is used to signal the unauthorized use of an opening. This device is equipped with two internal SPDT switches. One switch monitors both the push pad and the latch bolt assembly, making the latch bolt tamper resistant, for positive security. An additional SPDT switch is connected to the 1 1/4" (32mm) mortise cylinder with straight cam for alarm "bypass." (Schlage cam reference L583-477). The device can be connected to a security console, or may be used as a single door alarm when used with a horn and power supply.

Push pad reads: "Emergency Exit ONLY – Push To Open And Sound Alarm." Push pad is only available in US32D finish with red silk-screened lettering.

The SS mortise lock device is furnished with both the signal switch device and the SS7500 mortise lock. The SS7500 mortise lock has the versatility and advantages of the 7500 lock with the addition of signalling functions to monitor latch bolt operation and the trim locking function. The SS7500 mortise lock is supplied standard with the SS mortise lock device.

##### To order, specify:

- Prefix SS, example SS99L.
- Handing required, LHR or RHR.

##### Electrical ratings:

- Up to 2.0 amps @ 24VDC

#### Popular SS application

Unauthorized use of this opening will activate the local horn. The key switch permits inhibiting this system for authorized entry.

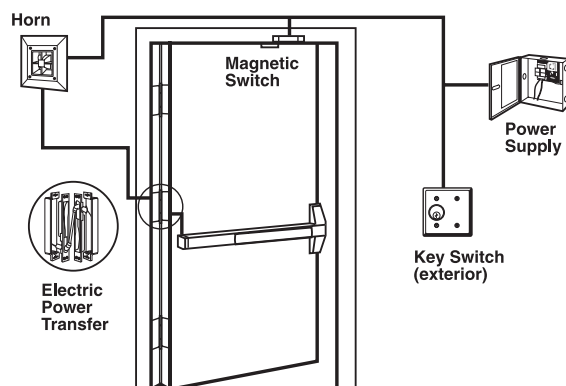

## Alarm kit



Alarm kit (ALK) is a simple yet effective way to deter unauthorized use of an opening. While the exit device is still a means of egress, the ALK kit contains an internal horn. When the touch bar is depressed, the horn sounds to provide an audible means of signaling that the opening has been violated. The alarm kit can be armed or disarmed by key thus allowing the exit device to be set in an armed or disarmed mode. The horn is rated at 85 decibels.

### For hardware applications

The assembly includes both a 24VDC Input and External Inhibit standard. The External Inhibit provides remote arming and dis-arming.

The key switch uses a standard 1 1/4" (32mm) mortise cylinder with a straight cam (Schlage 20-001, L583-477 cam). The unit operates on one standard 9-volt alkaline battery. When the battery is weak, the horn will emit an intermittent low battery alert signal.

Auto reset (AR) option is available with this kit. This kit allows the device to resume the alarm option after a preset time. Preset times can be field selected at 1.5, 3, or 4.5 minutes.

Alarm kits are available with a choice of two switch kits, RX or LX. RX monitors the touchpad and is furnished standard. LX optional latch bolt monitoring is recommended for use with surface vertical rod exit devices or when alarm needs to sound from both the exit device and trim side of the door. Specify ALK-LX.

Note: For latch bolt monitoring on a 98/9975 with ALK, specify a SS7500 lock. LX switch not available for 98/9975 devices.

The ALK is available in two styles, 99ALK, grooved cover and 98ALK, smooth cover.

The ALK includes a 6" x 20" decal for application on door "EMERGENCY EXIT ONLY. ALARM WILL SOUND." RSS push bar trim can be used instead of the door decal, specify RSS push bar trim when ordering the device.

When the ALK is used, standard dogging is removed. If cylinder dogging is required, there are two choices. Special center case dogging (SD) is available. Or, as an engineered special, the ALK can be moved to the hinge side of the device, and standard cylinder dogging (CD) can be added. Note size restrictions below.

### To order, specify:

1. Standard, 98 ALK
2. Special center case dogging, SD98 ALK
3. Cylinder dogging, CD98 ALK

### Minimum door opening sizes on ALK applications

Device	3' (914mm) Length	4' (1219mm) Length
98/98-F/99/99-F	2'10" (864mm)	3'4" (1016mm)
9875/9875-F/9975/9975-F	2'10" (864mm)	3'4" (1016mm)
9827/9827-F/9927/9927-F	2'10" (864mm)	3'4" (1016mm)
9857/9857-F/9957/9957-F	2'10" (864mm)	3'4" (1016mm)
9847/9847-F/9947/9947-F	2'9" (838mm)	3'3" (991mm)
9848/9848-F/9948/9948-F	2'9" (838mm)	3'3" (991mm)



## Electrified options

### Electrified mortise and electrified trim

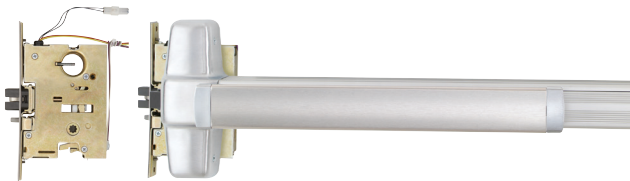

The electric mortise lock device has all the versatility and advantages of the standard mortise lock device, plus the advantage of being electrically controlled by a remote switching device, an access control system or an automatic fire alarm system. The device features the E7500 mortise lock. The E7500 controls the locking of the outside trim. When unlocked, the door remains latched, preserving the fire rating of the door and making it particularly useful where codes permit locking but require unlocking during a fire emergency. The outside trim cylinder retracts the latch bolt for mechanical override, night latch function. Only available with TP, K or L functions.

The E7500 lock contains a SPDT signal to monitor the outside trim condition (locked or unlocked) and a second SPDT signal switch to monitor the latch bolt.

#### Standard features:

- Field reversible handing
- 24 VDC continuous duty solenoid

#### Optional features:

- Fail safe (locked when energized, unlocked when de-energized or during power failure). Specify with suffix “FS.”
- Fail secure (unlocked when energized, locked when de-energized or during power failure). Specify with suffix “FSE”
- 24 VAC (with SO option)\*
- 12 VDC
- 12 VAC (with SO option)\*

Note: Some Fire codes will require “Fail Safe” (FS) operation for stairwell doors. Be sure to specify the correct operation for your application.

\* SO (silence operation) not recommended for continuously-powered devices.

#### Electrical specifications:

- Solenoid — .60 amps @ 12VDC  
.30 amps @ 24VDC
- Each switch — Up to 2.0 amps @ 24VDC Maximum

The E option does not include the power transfer from door to frame, the power supply or the control operator (Refer to EPT-10 and PS902 or PS914 power supply).

#### To order, specify:

1. Use prefix “E,” example E9975
2. FS or FSE
3. Voltage

#### Electric mortise lock device

Adaptable for openings where continuous latching is required while the trim may be electrically locked or unlocked from a remote location—stairwells, exterior doors, etc.

#### Minimum system requirements:

- PS902
- EPT-10 or electric hinge

#### E996L Electrified lever trim

E996L Electrified lever trim provides remote locking and unlocking. Available in either fail safe (FS) or fail secure (FSE) condition, but can also be field converted where allowed. E996L is furnished standard with cylinder operation for nightlatch (NL) function, or with blank escutcheon (BE).



#### Specification:

Solenoid – 0.6 amps @ 12 VDC,  
0.22 amps @ 24 VDC.

#### To order, specify:

1. Use “E” prefix, example E996L. When ordering with the exit device specify trim series with prefix “E”, example 9927L-BE 3' US26D E996.
2. Device type, R/V (rim/surface vertical rod/concealed vertical rod) or M (mortise).
3. RHR furnished standard if not specified, field reversible.
4. Lever style (06 lever furnished standard). Other levers, no extra charge.

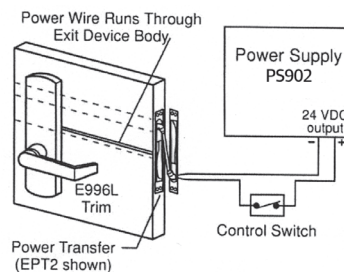

#### RX option

RX option available for 996 trim to monitor lever trim operation (available as L or L-BE). To order, add RX prefix to trim description.

**Note:** The RX switch option should not be used to control a load, but as a signaling switch only.

# Power supplies

## PS900 Series power supplies



The PS900 Series is a consolidated line of power supplies and accessories that offer enhanced flexibility and functionality specific to the changing needs of the access control market. The PS900 Series can be used in a variety of applications to convert high voltage AC power into the regulated low voltage DC outputs required by most access control devices. The PS900 Series protects devices downstream by providing Class 2<sup>1</sup>, filtered and regulated power. The full line is UL294 certified.

### Features:

- Constant output rating at both 12VDC or 24VDC provides superior performance; includes field selectable jumper
- Flat mounting of option boards provides easier access to terminal blocks for connection of electrified devices
- High voltage protective cover
- Battery back-up board auto-selects voltage
- Fire alarm relay can be configured to provide either switched or un-switched outputs from a power supply
- PS914 designed with high inrush current for powering electrified panic devices
- Universal 120-240 VAC input
- Low voltage DC, regulated and filtered
- Electronic power limiting foldback circuit for AC current overload protection
- Fused primary input
- AC status monitor- isolated SPDT contacts
- AC input and DC output LED status indicators
- Cover mounted AC input indication
- Hinged cover with lock down screws
- Optional keylock

### Certifications:

- UL 294 certified—the standard for access control
- Class 2 rated<sup>2</sup>

The PS900 Series offers a variety of distribution options, including basic fuse protection, simple relay, and advanced logic providing complex sequencing and timing functions.

### Connectors on the power supply

Product	Schlage PS902	Schlage PS904	Schlage PS906	Von Duprin PS914
Amperage	2 amps	4 amps	6 amps	4 amps with 16 amp inrush
Distribution boards	1	2	3	2
Battery back-up board	1	1	1	1
EL Compatible	No	No	No	Yes

### Applications:

The PS900 Series of power supplies works with many electrified devices including Schlage electromagnetic locks, Schlage AD Series hardwired locks, Schlage electrified mechanical locks, Von Duprin electrified strikes, Von Duprin exit devices and many other brands.

### Accessories:

The PS900 Series features seven option boards for use in a variety of applications. All PS900 Series power supplies option boards are UL 294 certified.

### Option boards:

- **900-4R:** 4 relay controlled output board to power multiple devices
- **900-4RL:** 4 relay distribution board with logic is field configurable for time delay function, auto operator, security interlock
- **900-8F:** Provides 8 individually fuse-protected outputs, giving the flexibility to power multiple devices and provide another layer of protection
- **900-8P:** Provides 8 individually fuse-protected outputs, giving the flexibility to power multiple devices and provide another layer of protection
- **900-FA:** Emergency interface relay integrates with fire alarm and is used to cut power in case of emergency<sup>2</sup>
- **900-BB:** Battery backup
- **900-2RS:** 2 relay control board for electric latch panic devices (EL or QEL), electric strikes or electrified trim
- **900-BBK:** Battery backup kit includes two 7A/hr batteries and provides up to four hours of backup power when cycled every 5 minutes at full load

1. PS906 can provide Class 2 rated outputs when used with 900-8P distribution board.  
 2. Except PS906, output rating exceeds Class 2 power limits.  
 3. PS906, output rating exceeds Class 2 power limits, but can provide Class 2 rated outputs when used with 900-8P distribution board.

## Electrified options

# Electrical and pneumatic power transfers

### Electrical power transfer (EPT)

### Pneumatic transfer (PNT)

Electrical Power Transfer provides a means of transferring electrical power from a door frame to the edge of a swinging door. The units are completely concealed when the door is in the closed position, and are ideal for installations involving abuse or heavy traffic.

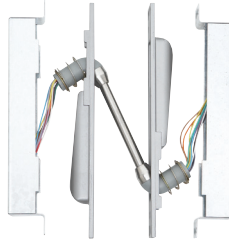

Two models are available; EPT-2, two 18 gauge wires and EPT-10, ten 24 gauge wires. The EPT-2 and EPT-10 are U/L listed as “miscellaneous door accessory”. UL Listed for use on fire doors.

### Door applications

Degree of opening	Hinge type	Door thickness
0-180	Up to 5" butt hinges	1 <sup>3</sup> / <sub>4</sub> "
0-180	Up to 3/4" offset pivots	1 <sup>3</sup> / <sub>4</sub> "
0-130	5 1/2" butt hinges	1 <sup>3</sup> / <sub>4</sub> "
0-110	6" butt hinges	1 <sup>3</sup> / <sub>4</sub> "
0-90	Swing clear hinges	1 <sup>3</sup> / <sub>4</sub> "

### Finishes

- SP28 (sprayed aluminum)
- SP313 (sprayed duranodic)

### Dimensions

Housing	9" x 1 1/4" x 1 5/8" (229mm x 32mm x 38mm)
EPT-2	Two 18 gauge wires, Up to 2 amps @ 24VDC, with a 16 amps Maximum Surge
EPT-10	Ten 24 gauge wires, Up to 1 amps @ 24VDC, with a 16 amps Maximum Surge
PNT-1	5/32" Tubing

### To order, specify:

1. EPT-2 ,EPT-10 or PNT-1
2. Finish, SP28 or SP313

# Allegion Connect

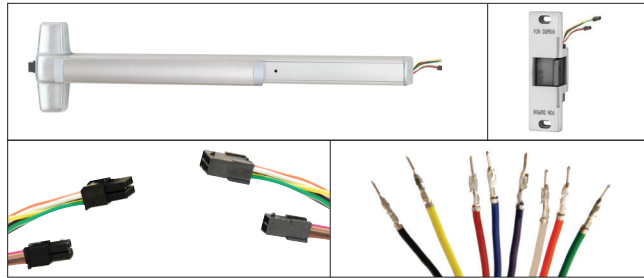

Allegion Connect features common interconnect components for many cross-category electrified options. Allegion Connect is a quick and easy way to connect power sources. There is no wire cutting; reducing installation and maintenance time ultimately cutting cost. After installation, Allegion Connect continues to provide benefits throughout the lifetime of the opening by offering a service kit for repairs or modifications in the future.

### Features and benefits

- Quick: common connections reducing installation time
- Perfect Connections: these factory installed connectors ensure the right wires match up every time
- Protective: the connectors protect the connection points throughout the installation process and lifetime of the opening
- Interchangeable: all Allegion Connect products utilize the same connectors
- Maintenance: you no longer need to cut away wire to disconnect Allegion products, also available is a service kit specifically for Allegion Connect products.

Harness length	Connectors on both ends	Connectors on one end, crimped pins on the other end
6 Inches	CON-6	CON-6P
12 Inches	CON-12	CON-12P
26 Inches	CON-26	CON-26P
32 Inches	CON-32	CON-32P
38 Inches	CON-38	CON-38P
44 Inches	CON-44	CON-44P
50 Inches	CON-50	CON-50P
192 Inches	CON-192	CON-192P

Power supply wire harness = connectors on one end, stripped leads on the other end.

6 Inches	CON-6W - wire extension to power supply
----------	---

Consult door manufacturer for harness length requirements.

**Note:** You will need to purchase a separate wiring harness to go from exit device to hinge/EPT and an additional harness to go from hinge/EPT to power supply or access control system. Harness part numbers with ordering information can be located in the Schlage, Von Duprin and Falcon pricebooks. A service kit is available for order in the Schlage, Von Duprin and Falcon pricebooks. Included in this kit are male end plugs, female end plugs and pins to customize harnesses to your application.

**Note:** Must be ordered with exit devices and locks

### To order, specify:

1. Specify CON for Connect electronic options  
Example: QEL-99-EO-CON  
(99 Series quiet electric latch retraction exit only with Connect connectors)
2. Specify harness length; Consult door manufacturer for harness length
3. Specify Von Duprin EPT10-CON or Ives electrical thru-wire hinge

### Wire run options

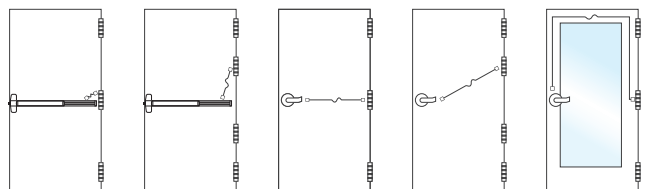

# Strikes

## Strikes for rim devices

264

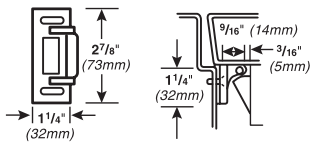

Projection 9/16" (14mm)

299

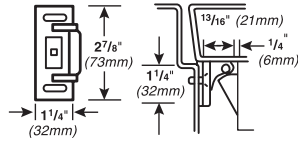

Projection 13/16" (21mm)

299F

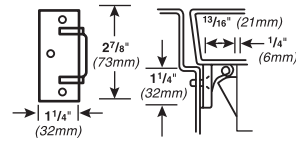

Projection 13/16" (21mm)

499F

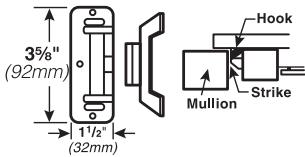

Projection 15/16" (24mm)

1408

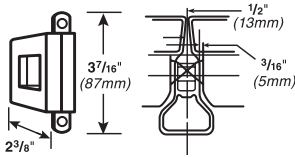

One per pair of doors

1439-Blade stop

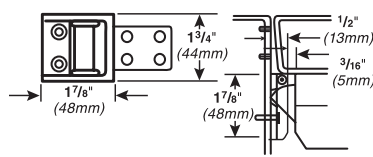

Projection 1/2" (13mm)

1410-Integral stop

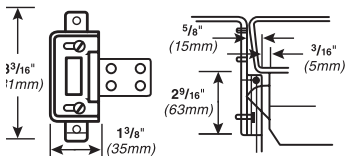

Projection 1/2" (13mm)

1606

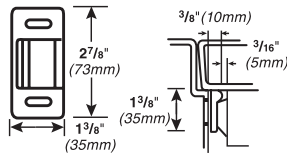

Projection 3/8" (10mm)  
(Panic devices only)

1609

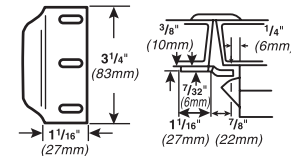

- Requires coordinator
- For panic exit application only, not fire rated

## XP Strikes for rim devices

909

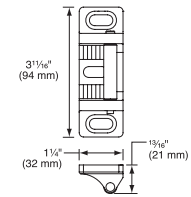

Projection 13/16" (21mm)

954

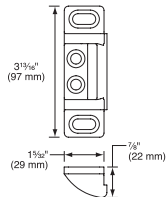

Projection 7/8" (22mm)  
(For fire rated double door applications)

## Strikes for vertical cable devices

249 - Top strike

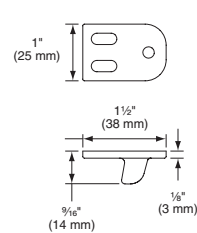

Projection 9/16" (14mm)

349 - Bottom strike

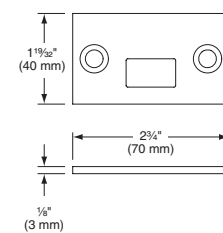

Projection 1/8" (3mm)

## Strikes for 98/9950WDC devices

150

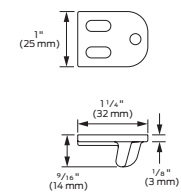

Projection 9/16" (14mm)

450

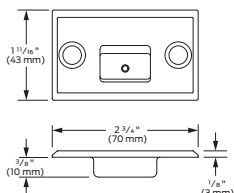

Projection 1/8" (3mm)

# Strikes

## Strikes for vertical rod devices

248L-4	260U-Flush transom panic only 260U-F-Flush transom fire only	299	299F	499F
Projection $\frac{3}{8}$ " (10mm)	Projection $\frac{3}{8}$ " (10mm)	Projection $\frac{13}{16}$ " (21mm)	Projection $\frac{13}{16}$ " (21mm)	Projection $\frac{15}{16}$ " (24mm)
304L	338	385A	283	
Projection $\frac{13}{16}$ " (21mm)	Mortise $\frac{5}{8}$ " (16mm)	Mortise $2\frac{1}{2}$ " (64mm)	For use with WDC devices when used with wood frames	

## Strikes for mortise lock devices

575	575-2	576A	576B
For use on $1\frac{3}{4}$ " (44mm) or $2\frac{1}{4}$ " (57mm) Single door and $2\frac{1}{4}$ " (57mm) double door with coordinator.	For use on $1\frac{3}{4}$ " (44mm) thick double door with coordinator and astragal.	Open back strike for $1\frac{3}{4}$ " (44mm) thick double doors without coordinator.	Open back strike for $2\frac{1}{4}$ " (57mm) thick double doors without coordinator.
		<ul style="list-style-type: none"> <li>Not for use with astragals</li> <li>For use on wood doors, contact door manufacturer</li> </ul>	<ul style="list-style-type: none"> <li>Acceptable for 90 minute pair of hollow metal doors</li> </ul>

# Cylinders

Cylinders are not furnished with device or trim and must be specified when ordering. Refer to trim pages for cylinder type.

**Mortise — 3215**  
(Schlage 20-001, L583-477 cam)

**Dogged (inverted) cam**

For CD, CDSI, CI and SD

**Rim — 3216**  
(Schlage 20-022)

**Undogged cam (standard operations)**

For 2, -2SI, ALK, CX, DE5300, RCM, SS and all 98/99 Series mortise cylinder trims and controls

## Accessories

### Door kits

#### Vertical rod and latch guard (RG-27)



Series RG-27 Vertical rod and latch guards protect the bottom rods of exit devices from the damaging impacts of carts or gurneys passing through doors. (If bottom rods become damaged, the exit device will not function as intended and can jeopardize the ability to exit safely during an emergency.)

In addition to protecting the vertical rod, the guard provides a smooth, unobstructed surface so the door can be pushed open easily with the bumpers of a wheelchair. The latch guard portion is 10" high. The standard latch guard features a 45° ramp. The extended latch guard offers a continuous ramp for 3' or 4' doors.

All stainless steel construction in 630 finish. Latch guards can cover latches as large as 1 1/4"W x 10"H x 1 7/8" projection.

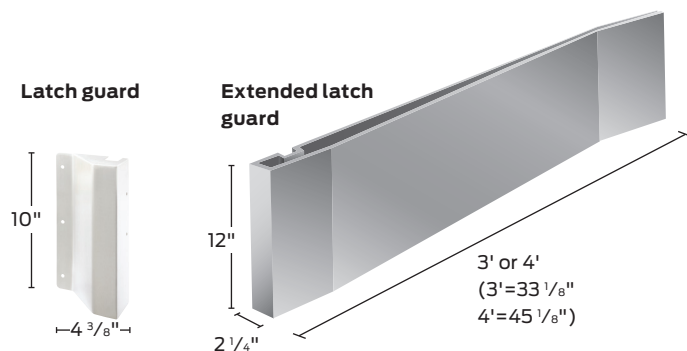

#### Models

RGO	Rod guard only (projection 1 3/16")
RG-27	Rod and latch guard
RG-27-3	3' (914mm) Rod guard and extended latch guard
RG-27-4	4' (1219mm) Rod guard and extended latch guard
LGO	Latch guard only
LGO-3	3' (914mm) Extended latch guard only
LGO-4	4' (1219mm) Extended latch guard only

When using on wood fire doors, high density block is required.

#### To order, specify:

1. Model number\*.
2. Handing (except on RGO).
3. Door material if other than hollow metal.
4. Optional sex bolt mounting available.

\* RGO/RG-27 includes one rod guard only, which accommodates bottom or top rod up to 7' door. For longer top rods, specify rod guard quantity required.

#### 997 Cover plate kit

For 98/99 rim device, kit contains inside and outside plates for hinge stile cutouts, an inside plate for the lock stile, and necessary screws. Plates are designed to cover cutouts required by most existing exit device installations. Specify finish.

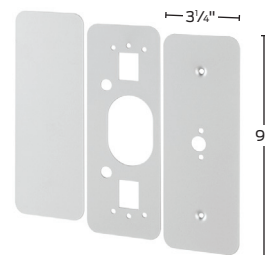

#### Wood door applications cover plate kit (WDA)

For wood door applications, used to cover up door preparations for control, also prevents the control from boring into the wood door. Finished to match control.

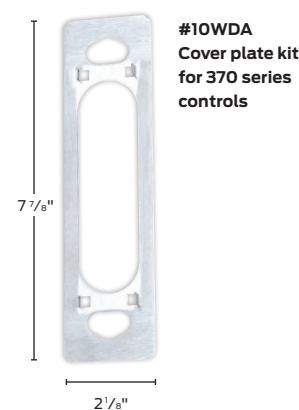

#### Glass bead kit (GBK)

Glass bead conversion kits are available for all 98/99 Series devices for use on doors with raised glass beads. Each kit consists of 1/4" (6mm) shim sets. GBK for surface vertical rod ships with 1/8" shims for rod guides.

#### To order, specify:

1. Device model.
2. GBK.
3. Device type (rim, mortise, surface rod, concealed rod, concealed cable).
4. Wood door (when used with concealed rod or concealed cable device).
5. Specify if using with 499F or 954 strike.
6. Finish.

#### Example: XP98 GBK Rim 954 SP28

Note: For 330/350 dummy pushbar, order hinge stile shim #971010, quantity 2.

# Sex bolts

Sex bolts provide secure mounting by mating with machine screws furnished with devices. Sex bolts are either optional or required, as shown in quantity chart below. Sex bolts ordered separately are not furnished with screws. If screws are required, order device mounting packages.

An alternative to sex bolt mounting is the use of UL or WH approved high density blocking material for wood fire-rated doors. Specify device with SLM (special laminate material) mounting package.

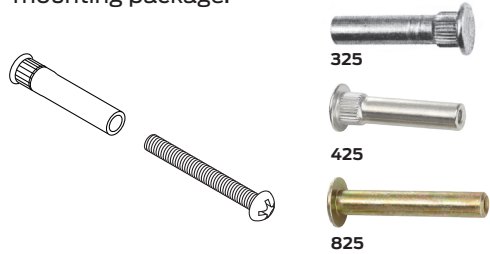

**To order sex bolts:**

1. If ordering devices with sex bolts, specify SNB (sex nuts and bolts) in device description.
2. If ordering sex bolts separately, specify:
  - Sex bolt model number
  - Package quantity (sold as package of 2)
  - Finish

Device type	Function	Sex bolts						
		425			325 for 499F hook		325 for latches	825
		Required Included in device price	Required Added to device price	Optional Added to device price	Required Added to device price	Optional Added to device price	Required Included in device price	Required Added to device price
98/99/XP98/XP99 Rim	EO, NL-OP DT, K, L, NL, TP, VR, 392, 696/697			6 2				
98/99/XP98/XP99 Rim-F, single door, metal door	EO, NL-OP DT, K, L, NL, TP, VR, 392, 696/697			6 2				
98/99/XP98/XP99 Rim-F, double door, metal door	EO, NL-OP DT, K, L, NL, TP, VR, 392, 696/697			6 2		2 2		
98/99/XP98/XP99 Rim-F, single door, wood door	EO, NL-OP, 392, 696/697* DT, K, L, NL, TP, VR		6 2					2
98/99/XP98/XP99 RIM-F, double door, wood door	EO, NL-OP, 392, 696/697* DT, K, L, NL, TP, VR		6 2		2 2			2
(HH)98/99/XP98/XP99 Rim panic and fire, single or double metal door	EO, NL-OP, 392, 696/697* DT, K, L, NL, TP, VR		6 2			2 2		
98/9927/57/-F	EO, NL-OP, TL-OP DT, K, L, NL, TP, TL, VR, 392, 696/697			6 2			4 4	2†
98/9927LBR/57LBR	EO, NL-OP, TL-OP DT, K, L, NL, TP, TL, VR, 392, 696/697			6 2			2 2	
98/9927LBR-F, metal door	EO, NL-OP, TL-OP DT, K, L, NL, TP, TL, VR, 392, 696/697			6 2		2 2	2 2	
98/9927LBR-F, wood door	EO, NL-OP, TL-OP DT, K, L, NL, TP, TL, VR, 392, 696/697			6 2	2 2		2 2	
HH98/9927/57/-F	EO, NL-OP, TL-OP, 392, 696/697* DT, K, L, NL, TP, TL, VR		6 2		2 2		4 4	
WS98/9927/57/-F	EO, 392 DT, L, VR	6 2					12 12	
98/9947/47WDC /48/49/50/-F, standard or LBR/LBL	EO, NL-OP, TL-OP DT, K, L, NL, TP, TL, VR, 392, 696/697			6 2				
HH98/9947/49/-F	EO, NL-OP, TL-OP, 392, 696/697* DT, K, L, NL, TP, TL, VR		6 2					
98/9952	EO L, L-BE			6 2				
98/9975/-F	EO, NL-OP DT, HL, K, L, NL, TP, 392, 696/697			6 2				
HH98/9975/-F	EO, NL-OP, 392, 696/697* DT, HL, K, L, NL, TP		6 2					

98/99/XP98/XP99 Rim-F, single or double door, SLM blocking

98/9927/57-F, SLM blocking

98/9947WDC/50-F, standard or LBR/LBL, SLM blocking

98/9975-F, SLM blocking

No sex bolts, all applications; special laminate material (SLM) blocking mounting package added to price

\* 696/697 must be milled on the back to sit flush against required 425 sex bolts

† These 825 sex bolts are only required for 98/9957-F on fire-rated wood doors with outside trim.



## Accessories

### Mullions

Removable steel mullions provide single door performance in double door openings with rim devices. Mullions are easily removed by loosening bottom set screw and removing top fitting cover. The top mullion fitting is attached to the frame and is concealed by the fitting cover.

- Steel mullions are 2" (51mm) wide and 3" (76mm) deep, with a wall thickness of  $\frac{1}{8}$ " (3mm)
- Mullions are shipped with mounting screws and prepared for strikes (strikes are not included except where indicated)
- Steel mullions are available in SP28 and SP313 finishes (Consult factory for other powder coat finish options)

#### Keyed removable steel mullions (KR)

KR mullions make removal faster and easier by a single operation of the mortise cylinder. Once mullion is removed, large equipment or furniture can freely pass through the opening. The unit will self lock when re-installed, without the use of the cylinder key. Uses a  $1\frac{1}{4}$ " mortise cylinder with a straight cam (Schlage cam reference L583-477). Cylinders are sold separately. Prefix mullion model with "KR".

Removable aluminum mullions are  $1\frac{1}{16}$ " (27mm) wide on face closest to the door and  $2\frac{3}{8}$ " (60mm) at the widest point. The depth is  $3\frac{1}{8}$ " (79mm) with a wall thickness of  $\frac{1}{8}$ " (3mm).

Aluminum mullions are available in 606, 612, 628, 710 and 622/711 finishes. Consult factory for other powder coat finish options. Aluminum mullions are not available keyed removable.

Stock hollow metal applications for devices mounted to cover ANSI 161 cutouts are higher than the standard mullion strike location. Consult the factory for special strike preparation or order a blank mullion. See below.

#### Blank mullions

are furnished without strike preparation. They are used to mount devices at a strike height different from the standard mullion preparation.

#### To order, specify:

1. For keyed removable option on steel mullions, prefix model number with "KR"
2. Model number
3. Height of opening
4. Finish
5. Handing if required
6. Centerline deviation (refer to device template for standard centerline)
7. Strikes, when required, should be ordered with device

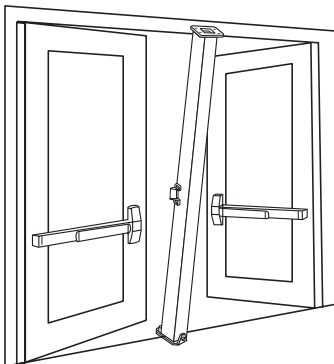

Removable mullions

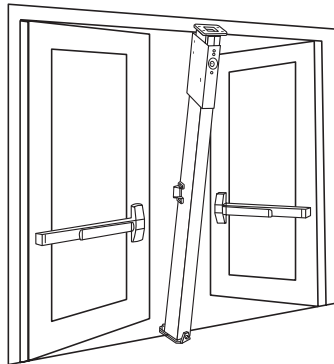

Keyed removable steel mullions

## Steel and aluminum mullions

### Steel mullions

- 1654** Prepared for two 1606 strikes. If 1606 strikes are not specified on the order, two per mullion will be added. Additional charges apply.
- 4954** Prepared for 264 or 299 strikes. For use with all Von Duprin Panic rim devices.
- 4954-XP** Prepared for two 909 strikes, for XP device.
- 9954**  Prepared for and must be used with two 268 strikes (88-F device), or two 499F (22-F, 98-F, 99-F devices). UL fire labeled mullion for up to 3 hour opening using Von Duprin fire exit rim devices. This mullion is not easily removed due to special fittings. 98-F and 99-F devices are rated up to 10'0" (3048 mm).
- 9954-XP** Prepared for two 954 strikes, for XP device.
- HH9954** Heavy-duty mullion for use in impact-rated hurricane assembly.

Note: If 268 or 499F strikes are not specified on the order, two per mullion will be added. Additional charges apply.

- 4754** Prepared for two 4263 monitor strikes.
- 4854** Prepared for one 299 and one 6111 electric strike. Indicate handing for electric strike.
- 9854**  Prepared for one 268 or 499F strike and one 6111 electric strike. Indicate handing for electric strike. UL fire labelled mullion for up to 3 hour openings up to 8' x 8' (2438mm x 2438mm) using Von Duprin fire exit rim devices

### Aluminum mullions

- 5654** Prepared for two 299 strikes.
- 5654-XP** Prepared for two 909 strikes, for XP device.
- 5754** Prepared for 1408 double strike.

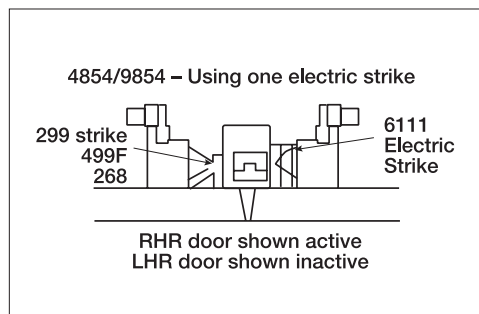
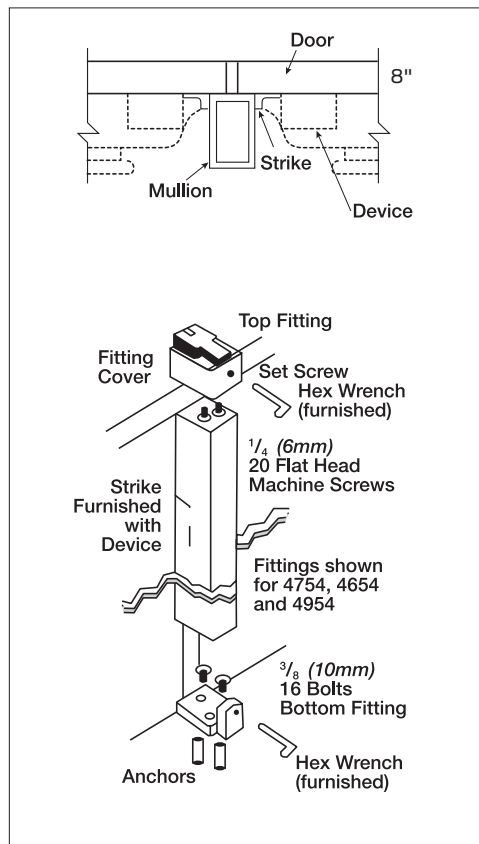

## Additional information

## UL Listing for fire exit hardware

## UL Listed fire exit hardware label and opening size

Exit device	Door material	Single door	Double door				V x V same direction	V x Mortise same direction	V x V double egress
			With 9954 mullion	With 9854 mullion	With KR9954 mullion	With KR9854 mullion			
98-F	Metal, composite (wood or plastic covered)	3 Hour	3 Hour	3 Hour	3 Hour	3 Hour	—	—	—
99-F		4' x 10'	8' x 10'	8' x 10'	8' x 10'	8' x 8'	—	—	—
98-F/99-F with 1439 Strike	Metal, composite (wood or plastic covered)	3 Hour 4' x 8'	—	—	—	—	—	—	—
XP98-F	Metal, composite (wood or plastic covered)	3 Hour	3 Hour	3 Hour	3 Hour	3 Hour	—	—	—
XP99-F		4' x 10'	8' x 10'	8' x 10'	8' x 8'	8' x 8'	—	—	—
9827-F	Metal	—	—	—	—	—	3 Hour <sup>1</sup> 8' x 10'	3 Hour 8' x 10'	3 Hour 8' x 10'
9927-F		—	—	—	—	—	—	—	—
9827LBR-F	Metal	—	—	—	—	—	3 Hour <sup>1</sup> 8' x 10'	—	3 Hour 8' x 10'
9927LBR-F		—	—	—	—	—	—	—	—
9847-F	Metal	—	—	—	—	—	3 Hour <sup>1</sup> 8' x 10'	3 Hour 8' x 10'	3 Hour 8' x 10'
9947-F		—	—	—	—	—	—	—	—
9847LBR-F	Metal	—	—	—	—	—	3 Hour <sup>1</sup> 8' x 9'	—	3 Hour 8' x 9'
9947LBR-F		—	—	—	—	—	—	—	—
9847WDC-F	Composite (wood or plastic covered)	—	—	—	—	—	90 Min <sup>1</sup> 8' x 9'3"	90 Min <sup>1</sup> 8' x 9'3"	90 Min <sup>1</sup> 8' x 9'3"
9947WDC-F		—	—	—	—	—	—	—	—
9847WDC-LBR-F	Composite (wood or plastic covered)	—	—	—	—	—	90 Min <sup>1</sup> 8' x 9'3"	90 Min <sup>1</sup> 8' x 9'3"	90 Min <sup>1</sup> 8' x 9'3"
9947WDC-LBR-F		—	—	—	—	—	—	—	—
9847WDC-LBR-F <sup>1</sup>	Wood core	—	—	—	—	—	20 Min no hose 8' x 9'3"	20 Min no hose 8' x 9'3"	20 Min no hose 8' x 9'3"
9947WDC-LBR-F <sup>1</sup>		—	—	—	—	—	—	—	—
9848-F	Metal	—	—	—	—	—	3 Hour <sup>1</sup> 8' x 10'	3 Hour 8' x 10'	3 Hour 8' x 10'
9948-F		—	—	—	—	—	—	—	—
9849-F	Metal	—	—	—	—	—	3 Hour <sup>1</sup> 8' x 10'	3 Hour 8' x 10'	3 Hour 8' x 10'
9949-F		—	—	—	—	—	—	—	—
9849LBL-F	Metal	—	—	—	—	—	3 Hour <sup>1</sup> 8' x 10'	—	3 Hour 8' x 10'
9949LBL-F		—	—	—	—	—	—	—	—
9850WDC-F	Composite (wood or plastic covered)	—	—	—	—	—	90 Min w/ edge wrap	—	—
9950WDC-F		—	—	—	—	—	1 Hour w/o edge wrap 8' x 8'	—	—
9850WDC-LBL-F	Composite (wood or plastic covered)	—	—	—	—	—	20 min with or without edge wrap, no hose 8' x 8'	—	—
9950WDC-LBL-F		—	—	—	—	—	—	—	—
9857-F	Metal	3 Hour	3 Hour	3 Hour	3 Hour	3 Hour	—	—	—
9957-F		4' x 10'	8' x 10'	8' x 10'	8' x 8'	8' x 8'	—	—	—
9857-F/9957-F with 1439 Strike	Metal	3 Hour 4' x 8'	—	—	—	—	—	—	—
9875-F	Metal	3 Hour	—	—	—	—	—	3 Hour 8' x 10'	—
9975-F		4' x 10'	—	—	—	—	—	—	—
WS9827-F	Metal	—	—	—	—	—	3 Hour <sup>1</sup> 8' x 8'	3 Hour 8' x 8'	3 Hour 8' x 8'
WS9927-F		—	—	—	—	—	—	—	—
WS9857-F	Metal	3 Hour	—	—	—	—	—	—	—
WS9957-F		4' x 8'	—	—	—	—	—	—	—

1. Not listed for Canada.

Note: Overlapping astragal may not be used on pairs swinging same direction with vertical rods or cables on both pairs. Check with door manufacturers to confirm listing compatibility.

# Function, grade and type options

## ANSI Function, grade and type

Function	Grade 1, type 1	Grade 1, type 2	Grade 1, type 3	Grade 1, type 7	Grade 1, type 7	Grade 1, type 8	Grade 1, type 8	Grade 1, type 8	Grade 1, type 9
1	98EO/-F 99EO/-F	9827EO/-F 9927EO/-F	9875EO/-F 9975EO/-F	9847WDCEO/-F 9947WDCEO/-F	9850WDCEO/-F 9950WDCEO/-F	9847EO/-F 9947EO/-F	9848EO/-F 9948EO/-F	9849EO/-F 9949EO/-F	9857EO/-F 9957EO/-F
2	98DT 99DT	9827DT 9927DT	9875DT 9975DT	9847WDCDT 9947WDCDT	9850WDCDT 9950WDCDT	9847DT 9947DT	9848DT 9948DT	9849DT 9949DT	9857DT 9957DT
3	98NL/-F 99NL/-F	9827NL/-F 9927NL/-F	9875NL/-F 9975NL/-F	9847WDCNL/-F 9947WDCNL/-F	9850WDCNL/-F 9950WDCNL/-F	9847NL/-F 9947NL/-F	9848NL/-F 9948NL/-F	9849NL/-F 9949NL/-F	9857NL/-F 9957NL/-F
3	98K-NL/-F 99K-NL/-F	9827K-NL/-F 9927K-NL/-F	9875K-NL/-F 9975K-NL/-F	9847WDCK-NL/-F 9947WDCK-NL/-F	9850WDCK-NL/-F 9950WDCK-NL/-F	9847K-NL/-F 9947K-NL/-F	9848K-NL/-F 9948K-NL/-F	9849K-NL/-F 9949K-NL/-F	9857K-NL/-F 9957K-NL/-F
3	98L-NL/-F 99L-NL/-F	9827L-NL/-F 9927L-NL/-F	9875L-NL/-F 9975L-NL/-F	9847WDCL-NL/-F 9947WDCL-NL/-F	9850WDCL-NL/-F 9950WDCL-NL/-F	9847L-NL/-F 9947L-NL/-F	9848L-NL/-F 9948L-NL/-F	9849L-NL/-F 9949L-NL/-F	9857L-NL/-F 9957L-NL/-F
5	98TP/-F 99TP/-F	9827TP/-F 9927TP/-F	9875TP/-F 9975TP/-F	9847WDCTP/-F 9947WDCTP/-F	9850WDCTP/-F 9950WDCTP/-F	9847TP/-F 9947TP/-F	9848TP/-F 9948TP/-F	9849TP/-F 9949TP/-F	9857TP/-F 9957TP/-F
7	98TP-2/-F 99TP-2/-F		9875TP-2/-F 9975TP-2/-F						
8	98K/-F 99K/-F	9827K/-F 9927K/-F	9875K/-F 9975K/-F	9847WDCK/-F 9947WDCK/-F	9850WDCK/-F 9950WDCK/-F	9847K/-F 9947K/-F	9848K/-F 9948K/-F	9849K/-F 9949K/-F	9857K/-F 9957K/-F
8	98L/-F 99L/-F	9827L/-F 9927L/-F	9875L/-F 9975L/-F	9847WDCL/-F 9947WDCL/-F	9850WDCL/-F 9950WDCL/-F	9847L/-F 9947L/-F	9848L/-F 9948L/-F	9849L/-F 9949L/-F	9857L & F 9957L/-F
10	98K-2/-F 99K-2/-F		9875K-2/-F 9975K-2/-F						
10	98L-2/-F 99L-2/-F		9875L-2/-F 9975L-2/-F						
11/12		9827TL/-F 9927TL/-F		9847WDC/-F 9947WDC/-F	9850WDC/-F 9950WDC/-F	9847TL/-F 9947TL/-F	9848/-F 9948/-F	9849/-F 9949/-F	9857TL/-F 9957TL/-F
14	98K-BE/-F 99K-BE/-F	9827K-BE/-F 9927K-BE/-F	9875K-BE/-F 9975K-BE/-F	9847WDCK-BE/-F 9947WDCK-BE/-F	9850WDCK-BE/-F 9950WDCK-BE/-F	9847K-BE/-F 9947K-BE/-F	9848K-BE/-F 9948K-BE/-F	9849K-BE/-F 9949K-BE/-F	9857K-BE/-F 9957K-BE/-F
14	98L-BE/-F 99L-BE/-F	9827L-BE/-F 9927L-BE/-F	9875L-BE/-F 9975L-BE/-F	9847WDCL-BE/-F 9947WDCL-BE/-F	9850WDCL-BE/-F 9950WDCL-BE/-F	9847L-BE/-F 9947L-BE/-F	9848L-BE/-F 9948L-BE/-F	9849L-BE/-F 9949L-BE/-F	9857L-BE/-F 9957L-BE/-F
16		9827TL-BE/-F 9927TL-BE/-F		9847WDC/-F 9947WDC/-F	9850WDC/-F 9950WDC/-F	9847TL-BE/-F 9947TL-BE/-F	9848/-F 9948/-F	9849/-F 9949/-F	9857TL-BE/-F 9957TL-BE/-F

## Dimensions

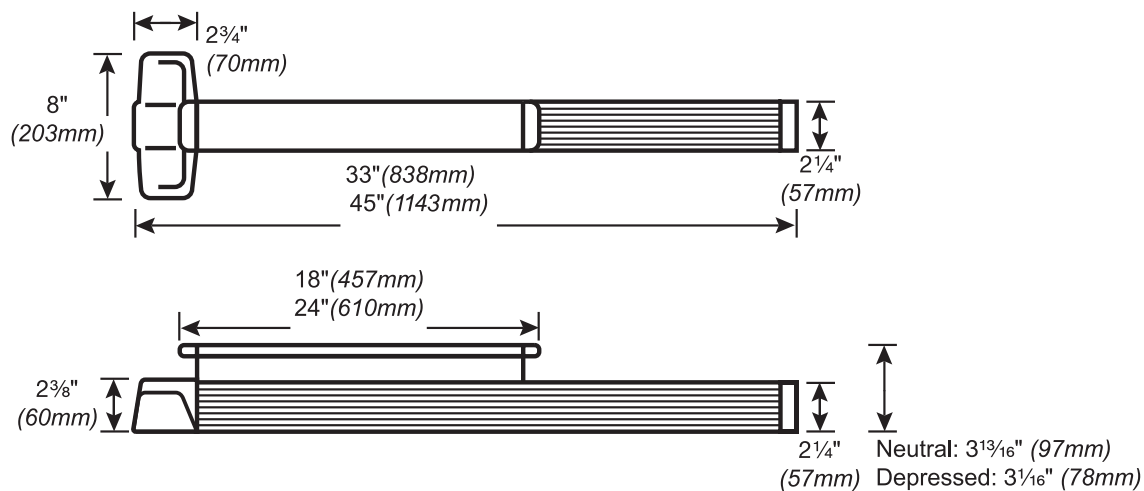

## Stile information

Device type	Standard single door		Standard double door		Optional single door		Optional double door				
	Strike	Trim/stile		Strike w/mullion*	Trim/Stile		Strike	Trim/Stile			
		990/996	696/697		990/996	696/697		990/996	696/697	990/996	696/697
98/99	299										
		4 1/2" (114mm)	4 3/8" (111mm)	299 x 4954	4 7/8" (124mm)	4 3/4" (121mm)	1439 or 1410	3 13/16" (97mm)	3 13/16" (97mm)	299 x 5654 (113mm) 1408 x 5754 (97mm)	4 1/4" (108mm) 4 1/4" (97mm)
XP 98/99	909			909 x 4954-XP			1606	4 1/16" (103mm)	3 15/16" (100mm)	1606 x 1654 (112mm)	4 3/8" (108mm)
98-F/99-F	299F			499F x 9954	4 7/8" (124mm)	4 3/4" (121mm)	—	—	—	499F x 9854 KR9954	—
XP98-F/ XP99-F	909			954 x 9954-XP			—	—	—	—	—
9875 9975	575			575-2	—	—	—	—	—	576A-576B	4 3/4" (121mm) 4 3/4" (121mm)
9875-F 9975-F	575	4 3/4" (121mm)	4 3/4" (121mm)	575-2	—	—	—	—	—	576A-576B	4 3/4" (121mm) 4 3/4" (121mm)
9857 9957	299 (Top) 299 (Middle) 304L/248L-4 (Bottom)	4 1/2" (114mm)	4 3/8" (111mm)	299 x 4954	4 7/8" (124mm)	4 3/4" (121mm)	1439 or 1410	3 13/16" (97mm)	3 13/16" (97mm)	299 x 5654 (113mm) 1408 x 5754 (97mm)	4 1/4" (108mm) 3 13/16" (97mm)
							1606	4 1/16" (103mm)	3 15/16" (100mm)	1606 x 1654 (112mm)	4 3/8" (108mm)
9857-F 9957-F	299F* (Top) 299F (Middle) 304L (Bottom)	4 1/2" (114mm)	4 3/8" (111mm)	299F 499F x 9954 304L	4 7/8" (124mm)	4 3/4" (121mm)	—	—	—	—	—

	Strike	Optional strike	Application	Trim/stile	
				990/996	696/697
9827 9927 Latch retraction	299 (Top) 304L/248L-4 (Bottom)	260U (Top) 385A (Bottom)	Single door	3 11/16" (94mm)	3 5/8" (92mm)
PL9827/PL9927 Pullman latch	299 (Top) 304L/248L-4 (Bottom)		Two vertical rod devices	3 11/16" (94mm)	3 5/8" (92mm)
9827-F 9927-F	299F* (Top) 304L (Bottom)	260U (Stainless) 385A (Bottom)			
9847 9947 9848 9948	338 (Top) 385A (Bottom)	304L (Bottom)	Vertical rod with Mortise lock device	4 3/4" (121mm)	4 3/4" (121mm)
9847-F 9947-F 9848-F 9948-F	338 (Top) 385A (Bottom)	304L (Bottom)	Two vertical rods Vertical rod with Mortise lock device	4 1/4" (108mm) 4 3/4" (121mm)	4 1/8" (105mm) 4 3/4" (121mm)
9847WDC 9947WDC	338 (Top) 385A (Bottom)	304L (Bottom)	Single door Two vertical rod devices	4 1/4" (108mm) 4 1/4" (108mm)	4 1/4" (108mm) 4 1/4" (108mm)
9847WDC-F 9947WDC-F	338 (Top) 385A (Bottom)	304L (Bottom)	Two vertical rod devices	4 1/4" (108mm)	4 1/4" (108mm)
9849 9949 9949	249 (Top) 349 (Bottom)	—	Vertical cable with Mortise lock device	4 3/4" (121mm)	4 3/4" (121mm)
9849-F 9949-F 9849-F 9949-F	249 (Top) 349 (Bottom)	—	Two vertical cable Vertical cable with Mortise lock device	4 1/4" (108mm) 4 3/4" (121mm)	4 1/8" (105mm) 4 3/4" (121mm)
9850WDC 9950WDC	150 (Top) 450 (Bottom)	—	Single door Two vertical Cable devices	4 3/4" (121mm) 4 3/4" (121mm)	4 3/4" (121mm) 4 3/4" (121mm)
9850WDC-F 9950WDC-F	150 (Top) 450 (Bottom)	—	Two Vertical Cable Devices	4 3/4" (121mm)	4 3/4" (121mm)

\*499F strike is the top strike for LBR applications.

# Lever styles and finishes

## Decorative levers

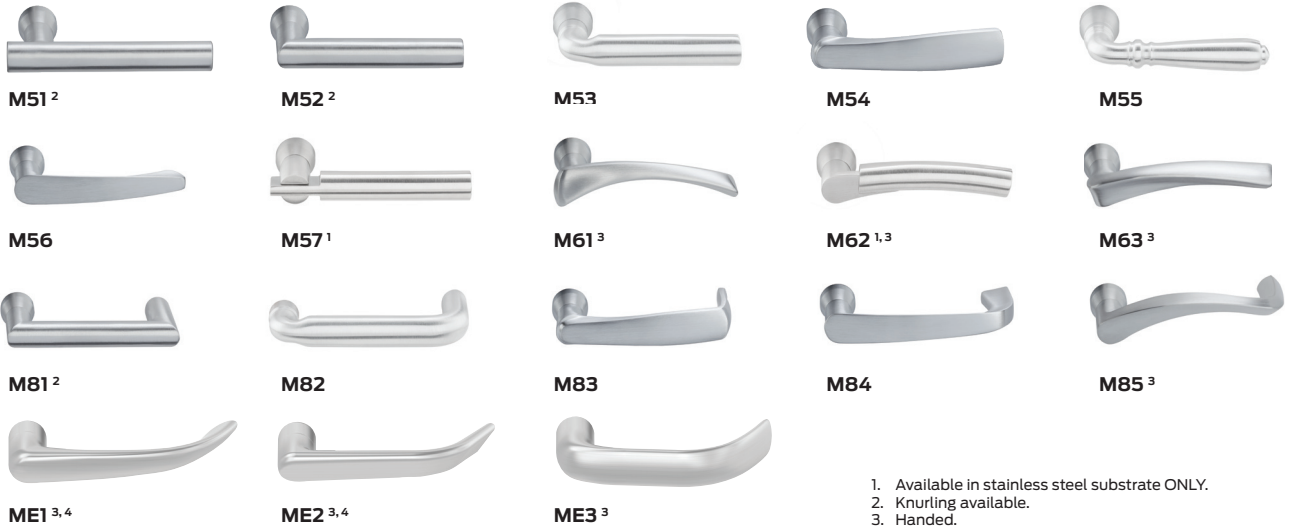

- 1. Available in stainless steel substrate ONLY.
- 2. Knurling available.
- 3. Handed.
- 4. Designed with Gensler as product design consultant.

## Standard levers

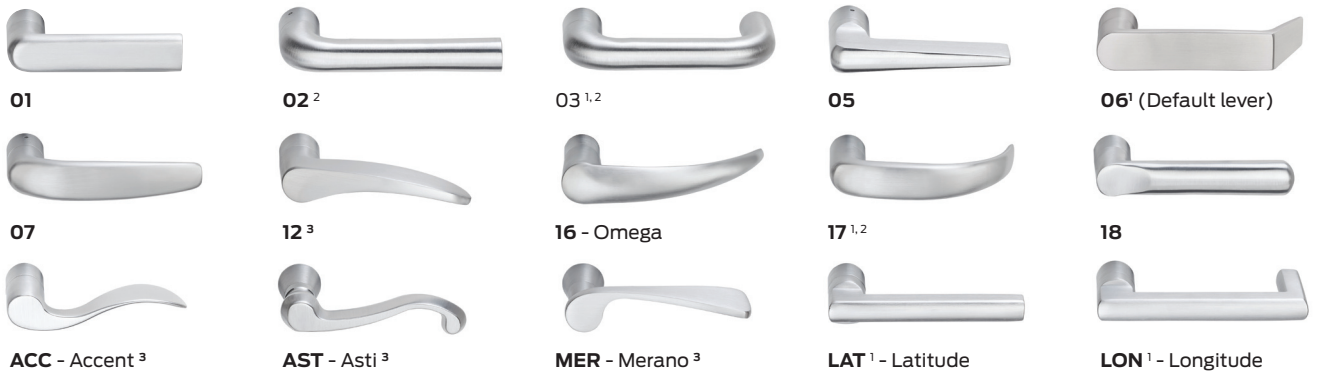

- 1. Available in Stainless Steel - specify SS when ordering.
- 2. Knurling available.
- 3. Handed.

Finish options*						
Color	Bright Brass	Satin Brass	Satin Bronze	Satin Nickel	Matte Black/Anodized	Bright Chrome
ANSI/BHMA number	605	606	612	619	622/711	625

Finish options*						
Color	Satin Chrome	Aluminum, anodized	Satin Stainless	Aged Bronze	Black Paint	Dark Brown, Anodized
ANSI/BHMA number	626/626AM†	628	630/630AM†	643e	693	710

\* Durable powder coated finishes available at special request. Please contact factory.  
 † AM = Antimicrobial

## Device finish options

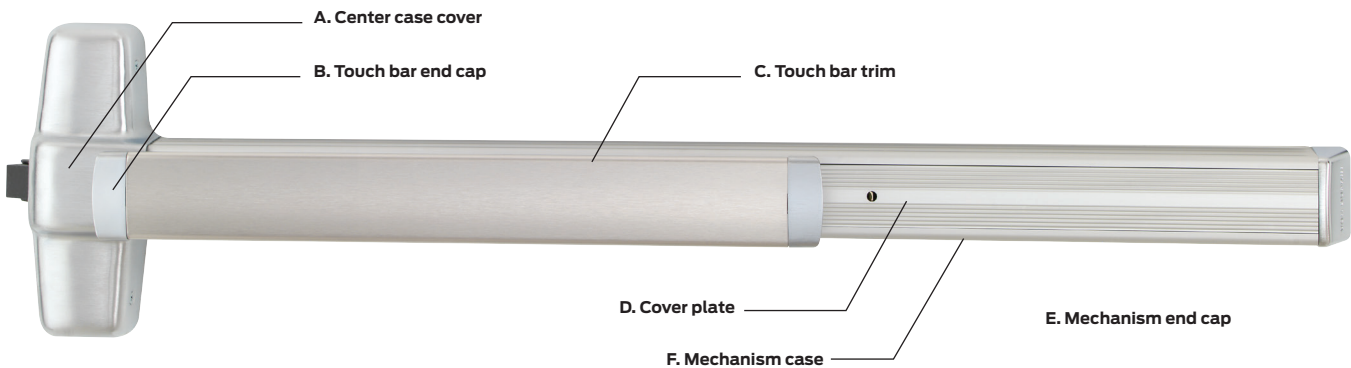

### Finishes

Color	BHMA number	A, B, E	C	D and F
Bright brass	605	Bright brass	Bright brass, 605	Buffed anodized
Satin brass	606	Satin brass	Satin brass, 606	Anodized
Satin bronze	612	Plated	Satin bronze, 612	Anodized
Satin bronze, oil-rubbed	613	Oil rubbed bronze	Oil rubbed bronze, 613	Powder coat
Bright chrome	625	Plated	Bright stainless steel, 629	Buffed anodized
Satin chrome	626	Plated	Satin stainless steel, 630	Anodized
Satin stainless steel*	630	Stainless steel	Satin stainless steel, 630	Anodized
Aluminum, anodized	628	Powder coat	Satin stainless steel, 630	Anodized
Duranodic dark bronze	710	Powder coat	Powder coat	Powder coat
Black	622	Powder coat	Powder coat	Powder coat
Aged bronze	643e	Relieved aged bronze	Relieved aged bronze	Aged bronze, no relief

## About Allegion

Allegion (NYSE: ALLE) is a global pioneer in seamless access, with leading brands like CISA®, Interflex®, LCN®, Schlage®, SimonsVoss® and Von Duprin®. Focusing on security around the door and adjacent areas, Allegion secures people and assets with a range of solutions for homes, businesses, schools and institutions. Allegion had \$2.7 billion in revenue in 2020, and its security products are sold around the world.

For more, visit [www.allegion.com](http://www.allegion.com)

KRYPTONITE ■ LCN ■  ■ STEELCRAFT ■ VON DUPRIN