

**VON DUPRIN®**

22 Series

Exit devices





<b>How to order</b>	<b>4</b>
<b>Device types</b>	<b>5</b>
22 Rim exit device	6
22-F Rim exit device	7
2227 Surface mounted vertical rod device	8
2227-F Surface mounted vertical rod fire exit device	9
<b>Trim options</b>	<b>10</b>
Trim functions	10
No trim	11
210 trim	12
230 trim	13
Electronic locks from Schlage	14
<b>Mechanical options</b>	<b>16</b>
Dogging options	16
Accessibility options	16
Latches	16
Hurricane rated devices	17
<b>Electrified options</b>	<b>18</b>
Switches	18
Alarm kit	18
Electrical power transfers	19
Allegion Connect	19
<b>Accessories</b>	<b>20</b>
Strikes	20
Cylinders	20
Door kits	21
Through bolts	22
Mullions	23
Steel and aluminum mullions	24
<b>Additional information</b>	<b>25</b>
UL Listing for fire exit hardware	25
Function, grade and type options	25
Minimum stile information	26
Lever styles and finishes	26

### Information and customer care



[us.allegion.com](http://us.allegion.com)



US 877.671.7011  
Canada 800.900.4734



[support@allegion.com](mailto:support@allegion.com)  
[Exits\\_TechProdSupport@allegion.com](mailto:Exits_TechProdSupport@allegion.com)



[www.youtube.com/VonDuprinSafety/](http://www.youtube.com/VonDuprinSafety/)

### Ordering



[allegion\\_orders@allegion.com](mailto:allegion_orders@allegion.com)



eFax: 1.800.999.0328





## Built to protect

Von Duprin® products symbolize a commitment to safety and security. It's evident in the meticulous engineering behind every exit device. After all, keeping our customers—and the people they strive to protect—safe is our priority. It's why Von Duprin goes the extra mile to provide durable and dependable products for every application.

The 22 Series is a cost-effective solution for medium to low traffic areas where proven reliability is needed. The non-handed design of the 22 Series makes it more adaptable in the field. And unique features set the series apart, including the AX option that is UL certified to meet ADA and California Building Code requirements for 5 lb. operating force.

## Passion driving performance

With superior products comes exceptional customer care. Von Duprin customers are supported by industry-leading expertise. Allegion's representatives have decades of experience, so you're assured to receive knowledgeable advice on fire and life safety codes, installation resources and more. And for those looking to take their skills to the next level, Allegion offers instructor-led workshops, videos and online courses. It's another way Von Duprin stands by our customers—today, tomorrow and for years to come.

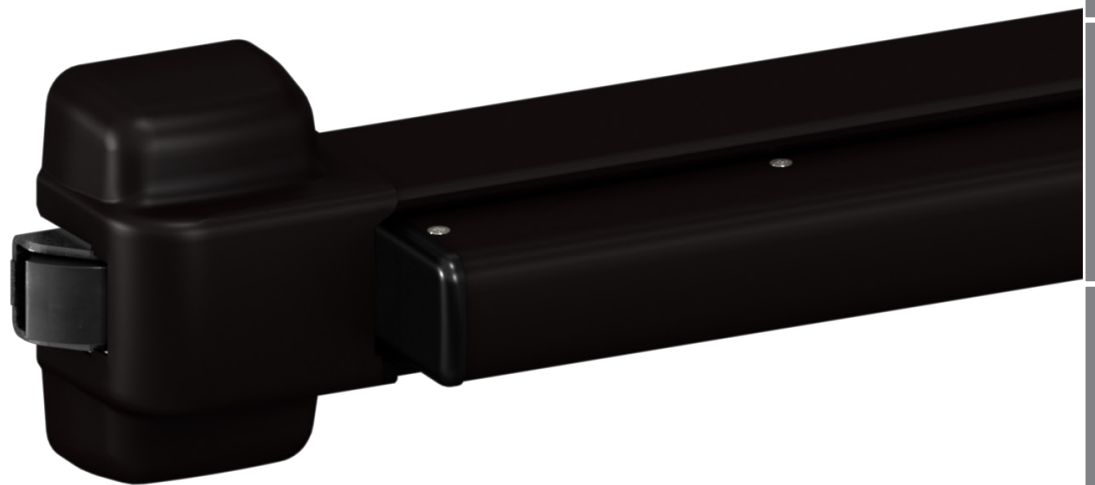

# Nomenclature – how to order

Prefix	Device series/type	Trim/rating	Suffix/finish	Door width	Handing	Less bottom rod/cable	Trim options/finish	Lever style	Strike options/finish	Accessories	Other information			
1	2	3	4	5	6	7	8	9	10	11	12	13	14	15
RX	- 22	- 27	- L - F	- -	- 689	- 3'	- RHR	-	LBR	- XX	- 06	- XX	- ALK	- HMD

## Detail

### 1 Prefixes

<b>None</b>	Standard
<b>AX</b>	Accessible device
<b>HW</b>	Hurricane device - Wind-Only
<b>LD</b>	Less dogging
<b>LX</b>	Latch bolt monitoring
<b>LX-LC</b>	Latch bolt monitoring, low current
<b>LX-RX</b>	Latch bolt monitoring, request to exit
<b>LX-RX-LC</b>	Latch bolt monitoring, request to exit low current
<b>PL</b>	Pullman latch
<b>RX</b>	Request to exit
<b>RX2</b>	Double request to exit
<b>RX-LC</b>	Request to exit, low current
<b>WP-RX</b>	Waterproof request to exit

### 2 Device series

<b>22</b>	Series 22
-----------	-----------

### 3 Device type

<b>None</b>	Rim device
<b>27</b>	Surface mounted vertical rod device

### 4 Trim functions

<b>EO</b>	Exit only
<b>DT</b>	Dummy trim
<b>K</b>	Knob (classroom)
<b>K-BE</b>	Knob - blank escutcheon <sup>2</sup>
<b>L</b>	Lever (classroom) <sup>1</sup>
<b>L-BE</b>	Lever - blank escutcheon <sup>2</sup>
<b>NL</b>	Night latch (key retracts latchbolt)
<b>NL-OP</b>	Night latch cylinder assembly, optional pull
<b>TP</b>	Thumbpiece
<b>TP-BE</b>	Thumbpiece - blank escutcheon <sup>2</sup>

### 5 Rating

<b>F</b>	Fire exit hardware
<b>Blank</b>	Panic exit hardware

### 6 Suffix

<b>CON</b>	Connectors
------------	------------

### 7 Finish

<b>526</b>	Powder Coated Chrome
<b>622</b>	Powder Coated Matte Black
<b>689</b>	Powder Coated Aluminum
<b>695</b>	Powder Coated Dark Bronze

### 8 Door width

<b>3'</b>	Standard default; advise if different (only available up to 48")
-----------	--

### Door thickness

<b>1 3/4"</b>	Standard; up to 2 1/4"
---------------	------------------------

### 9 Handing

<b>LHR</b>	Left hand reverse
<b>RHR</b>	Right hand reverse

### 10 Less bottom rod/cable

<b>LBR</b>	Less bottom rod
------------	-----------------

### 11 Trim options/finish

See trim options/finish for each device type

### 12 Lever style

<b>06</b>	Standard default (optional levers available)
<b>03</b>	
<b>17</b>	

### 13 Strike options/finish

See strike options/finish for each device type

### 14 Accessories

<b>ALK</b>	Alarm kit
<b>CYL</b>	Cylinder
<b>GBK</b>	Glass bead kit
<b>SEC</b>	Security screws
<b>SNB</b>	Through bolts

### 15 Other information

#### Door height

<b>7'</b>	Standard; advise if different
-----------	-------------------------------

#### Door material

<b>ALD</b>	Aluminum door
<b>HMD</b>	Hollow metal
<b>WD</b>	Wood door

#### Device center line

See specifications; advise if different than standard

#### Door application

<b>DE</b>	Double egress (surface vertical)
<b>PR</b>	Pair of doors (standard for surface vertical)
<b>SGL</b>	Single door (standard for rim)

#### Door listing

<b>3 hour</b>
<b>1 1/2 hour</b>
<b>1 hour</b>
<b>45 minute</b>
<b>20 minute</b>

1. L-NL not available.  
2. Passage

Note: Not all options are listed. See the specific device type pages for complete options available.

## Device types

As the pioneer in the industry, Von Duprin continues to advance the industry through customer-centric innovation, which delivers solutions to the most challenging applications.

Backed by high quality standards, Von Duprin exit devices were among the first in the industry certified to ANSI/BHMA A156.3 (2014) Grade 1. Our exit devices are tested to the highest standards and proven in the field to perform under heavy use and abuse, giving you peace of mind both now and in the future.

The versatile design can be easily upgraded to connect to a larger electronic ecosystem, empowering you to adapt with flexible solutions. You can configure numerous variations in the field without replacing your device and protecting your investment. This makes upgrades easy and cost effective.

## Popular applications

### Single door applications

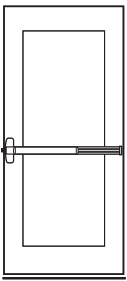

Single rim device

### Double door applications

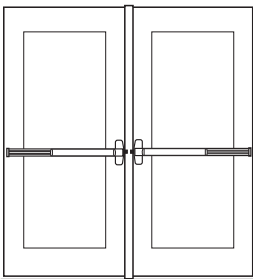

Two rim devices with mullion—same direction

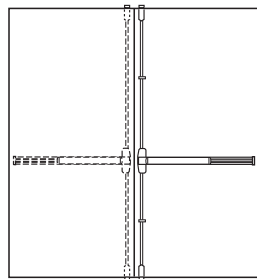

Two vertical rods - double egress

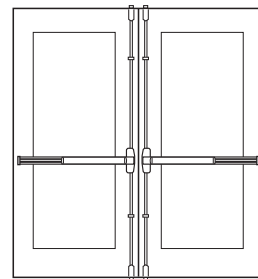

Two surface mounted vertical rod devices—same direction\*

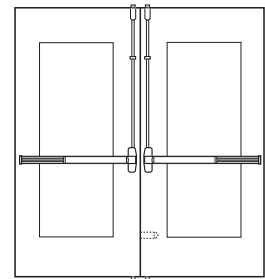

Two surface mounted vertical rod devices, less bottom rod (LBR). For LBR fire device, auxiliary fire pin is required.\*

\* Do not use with overlapping astragals

### Door handing

Left hand-reverse orientation

Right hand-reverse orientation

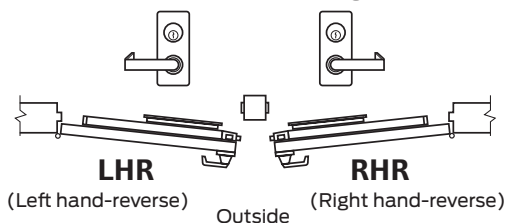

## 22 Rim exit device



22 Rim exit device for all types of single and double doors with mullion, UL listed for panic exit hardware. Devices are ANSI A156.3, 2014 Grade 1. Covers stock hollow metal doors with 161\* cutouts. Fits door stiles as narrow as 3 13/16" (97 mm). The device is non-handed.

\*Not applicable with all strike and mullion combinations, consult factory.

### Specifications

Device functions	Ships ready for all functions, EO, DT, NL, TP, K, L	
Device lengths	3' (914 mm)	4' (1219 mm)
	Note: See minimum door opening chart at bottom of page.	
Device centerline from finished floor	39 13/16" (1011 mm)	39 11/16" (1008 mm) with mullion
Center case	4 5/32" (105 mm) x 3 3/16" (81 mm) x 2 3/8" (60 mm)	
Mechanism case	2" (51 mm) x 2 3/8" (60 mm)	
Projection	Push bar neutral - 3 11/16" (94 mm) push bar depressed - 2 7/8" (73 mm)	
Latch bolt	Deadlocking, 3/4" (19 mm) throw	
Finishes	526, 622, 689, 695	
Fasteners and through bolts (SNB)	Includes screw pack for 1 3/4" (44 mm) and 2 1/4" (57 mm) wood and metal doors; optional SNB available for device (see page 25 for quantities)	

Note: Black end caps are standard for all finishes, with the exception of 526. Optional black metal end caps are available; order #900397 as a separate line item. Additional charges apply. All devices configured in 526 finish will be supplied with a metal endcap in 526 finish as standard.

### Minimum door opening chart

Stop height	Strike	Single door	Double door w/mullion	Minimum door opening for 3' device*	Minimum door opening w/ALK*
1/2"	299	Yes	—	26.500" (673 mm)	33.250" (845 mm)
1/2"	1439	Yes	—	25.687" (652 mm)	32.437" (824 mm)
1/2"	299	—	4754 4854 4954	27.000" (686 mm)	33.750" (857 mm)
1/2"	299	—	5654	25.812" (656 mm)	32.562" (827 mm)
1/2"	1408	—	5754	25.750" (679 mm)	32.500" (826 mm)
1/2"	1606	—	1654	26.562" (675 mm)	33.312" (846 mm)
1/2"	299	Yes	—	26.750" (679 mm)	33.500" (851 mm)
5/8"	1439	Yes	—	25.937" (659 mm)	32.687" (830 mm)
5/8"	299	—	4754 4854 4954	27.125" (689 mm)	33.875" (860 mm)
5/8"	299	—	5654	26.687" (678 mm)	33.437" (849 mm)
5/8"	1408	—	5754	25.875" (657 mm)	32.625" (829 mm)
5/8"	1606	—	1654	26.687" (678 mm)	33.437" (849 mm)

\* For 4' device, add 6" (152 mm).

### Features and options

#### Electrified options

<b>ALK</b>	Alarm exit kit
<b>CON</b>	Allegion Connect
<b>LX</b>	Latch bolt monitor switch
<b>LX-LC</b>	Latch bolt monitoring, low current
<b>LX-RX</b>	Latch bolt monitoring, request to exit
<b>LX-RX-LC</b>	Latch bolt monitoring, request to exit low current
<b>RX</b>	Request to exit
<b>RX2</b>	Double request to exit
<b>WP-RX</b>	Waterproof request to exit

#### Mechanical options

<b>AX</b>	Accessible device
<b>GBK</b>	Glass bead kit
<b>HW</b>	Hurricane device - Wind-Only

#### Dogging feature

Hex key dogging standard

#### Dogging options

<b>LD</b>	Less dogging
-----------	--------------

#### Strikes

**299** – Dull black

### Accessories



#### 299 Strike

Ships standard, optional strikes available.



#### Hex key dogging

Comes standard on 22 rim exit devices.

## Device types

### 22-F Rim exit device



22-F Rim fire exit devices for all types of single doors up to 4' x 8' (1219 mm x 2438 mm) or 8' x 8' (2438 mm x 2438 mm) double doors with 9954 or 9854 mullion, UL listed for fire exit hardware. Devices are ANSI A156.3 – 2014 Grade 1. Fits door stiles as narrow as 4 <sup>3</sup>/<sub>8</sub>" (111 mm). The device is non-handed.

#### Specifications

Device functions	Ships ready for all functions, EO, DT, NL, TP, K, L
Device lengths	3' (914 mm) 4' (1219 mm) Note: See minimum door opening chart at bottom of page.
Device centerline from finished floor	39 <sup>13</sup> / <sub>16</sub> " (1011 mm) 39 <sup>11</sup> / <sub>16</sub> " (1008 mm) with mullion
Center case	4 <sup>5</sup> / <sub>32</sub> " (105 mm) x 3 <sup>3</sup> / <sub>16</sub> " (81 mm) x 2 <sup>3</sup> / <sub>8</sub> " (60 mm)
Mechanism case	2" (51 mm) x 2 <sup>3</sup> / <sub>8</sub> " (60 mm)
Projection	Push bar neutral - 3 <sup>11</sup> / <sub>16</sub> " (94 mm) push bar depressed - 2 <sup>7</sup> / <sub>8</sub> " (73 mm)
Latch bolt	Deadlocking, <sup>3</sup> / <sub>4</sub> " (19 mm) throw
Finishes	526, 622, 689, 695
Fasteners and through bolts (SNB)	Includes screw pack for 1 <sup>3</sup> / <sub>4</sub> " (44 mm) and 2 <sup>1</sup> / <sub>4</sub> " (57 mm) wood and metal doors; optional SNB available for device (see page 25 for quantities)

Note: Black end caps are standard for all finishes, with the exception of 526. Optional black metal end caps are available; order #900397 as a separate line item. Additional charges apply. All devices configured in 526 finish will be supplied with a metal endcap in 526 finish as standard.

#### Minimum door opening chart

Stop height	Strike	Single door	Double door w/mullion	Minimum door opening for 3' device*	Minimum door opening w/ALK*
1/2"	299F/499F	Yes	—	26.500" (673 mm)	33.250" (845 mm)
1/2"	299F/499F	—	KR/9854/9954	27.000" (686 mm)	33.750" (857 mm)
5/8"	299F/499F	Yes	—	26.750" (679 mm)	33.500" (851 mm)
5/8"	299F/499F	—	KR/9854/9954	27.125" (689 mm)	33.875" (860 mm)

\* For 4' device, add 6" (152 mm).

#### Features and options

##### Electrified options

<b>ALK</b>	Alarm exit kit
<b>CON</b>	Allegion Connect
<b>LX</b>	Latch bolt monitor switch
<b>LX-LC</b>	Latch bolt monitoring, low current
<b>LX-RX</b>	Latch bolt monitoring, request to exit
<b>LX-RX-LC</b>	Latch bolt monitoring, request to exit low current
<b>RX</b>	Request to exit
<b>RX2</b>	Double request to exit
<b>WP-RX</b>	Waterproof request to exit

##### Mechanical options

<b>AX</b>	Accessible device
<b>GBK</b>	Glass bead kit
<b>HW</b>	Hurricane device - Wind-Only

##### Dogging option

No mechanical dogging

##### Strikes

**299F** – Dull black, 499F with mullions

#### Accessories



##### 299F Strike

Ships standard, optional strikes available.



##### 499F Strike

With 9854/9954 mullion.

# 2227 Surface mounted vertical rod device

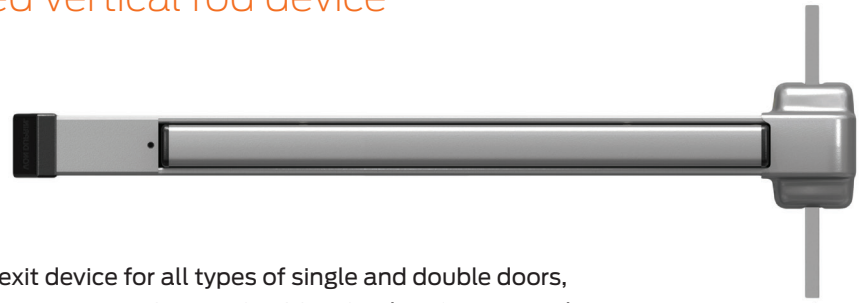

2227 Surface mounted vertical rod exit device for all types of single and double doors, UL listed for panic exit hardware. Devices are ANSI A156.3 – 2014 Grade 1. Covers stock hollow metal doors with 86 or 161 cutouts. Fits door stiles as narrow as 3 5/8" (92 mm). The device is non-handed.

### Specifications

Device functions	Ships ready for all functions, EO, DT, NL, TP, K, L
Device lengths	3' (914 mm) 4' (1219 mm) <small>Note: See minimum door opening chart at bottom of page.</small>
Door height	7' (2134 mm) standard door height <small>Note: 3' extension rods available for door heights up to 10' (3048 mm).</small>
Device centerline from finished floor	39 13/16" (1011 mm)
Center case	4 5/32" (105 mm) x 3 3/16" (81 mm) x 2 3/8" (60 mm)
Mechanism case	2" (51 mm) x 2 3/8" (60 mm)
Projection	Push bar neutral - 3 1/16" (94 mm) push bar depressed - 2 7/8" (73 mm)
Door undercut	1/4" (7 mm) from finished floor recommended, 3/4" (19 mm) maximum or 1/8" (3 mm) from threshold
Latch bolt	Deadlocking anti-friction top and bottom bolt, 5/8" (16 mm) throw
Finishes	526, 622, 689, 695
Fasteners and through bolts (SNB)	Includes screw pack for 1 3/4" (44 mm) and 2 1/4" (57 mm) wood and metal doors; optional SNB available for device (see page 25 for quantities)

Note: Black end caps are standard for all finishes, with the exception of 526. Optional black metal end caps are available; order #900397 as a separate line item. Additional charges apply. All devices configured in 526 finish will be supplied with a metal endcap in 526 finish as standard.

### Minimum door opening chart

Stop height	Strike	Single door	Double door w/mullion	Minimum door opening for 3' device*	Minimum door opening w/ALK*
1/2"	N/A	Yes	Vert. x Vert.	25.875" (657 mm)	32.625" (829 mm)
5/8"	N/A	Yes	Vert. x Vert.	26.000" (664 mm)	32.750" (832 mm)

\* For 4' device, add 6" (152 mm).

### Accessories



**299 Top strike**



**Top latch**



**304L Bottom strike**



**248L4 Bottom strike**  
For use with flat threshold



**Bottom latch**



**Hex key dogging**  
Comes standard on 2227 devices.

### Features and options

#### Electrified options

- ALK** Alarm exit kit
- CON** Allegion Connect
- LX** Latch bolt monitor switch
- LX-LC** Latch bolt monitoring, low current
- LX-RX** Latch bolt monitoring, request to exit
- LX-RX-LC** Latch bolt monitoring, request to exit low current
- RX** Request to exit
- RX2** Double request to exit
- WP-RX** Waterproof request to exit

#### Mechanical options

- GBK** Glass bead kit
- HW** Hurricane device - Wind-Only
- PL** Pullman latch

#### Dogging feature

Hex key dogging standard

#### Dogging options

- LD** Less dogging

#### Strikes

- Top** – 299 – Dull black
- Bottom** – 248L4 and 304L – Unfinished



## Device types

# 2227-F Surface mounted vertical rod fire exit device

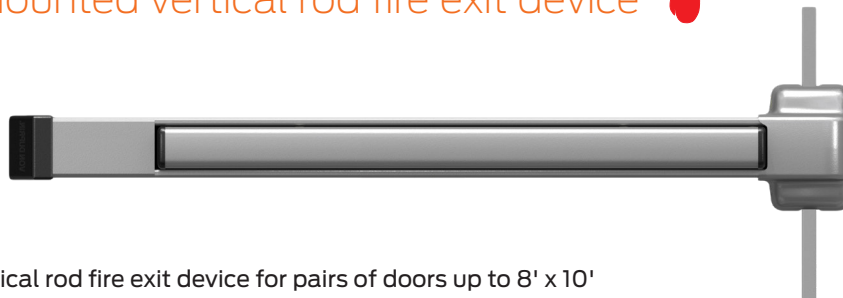

2227-F Surface mounted vertical rod fire exit device for pairs of doors up to 8' x 10' (2438 mm x 3048 mm), UL listed for Fire Exit Hardware. Devices are ANSI A156.3 – 2014 Grade 1. Fits door stiles as narrow as 3 5/8" (92 mm). The device is non-handed.

### Specifications

Device functions	Ships ready for all functions, EO, DT, NL, TP, K, L
Device lengths	3' (914 mm) 4' (1219 mm) Note: See minimum door opening chart at bottom of page.
Door height	7' (2134 mm) standard door height 12" (205 mm), door height 36" (914 mm), door height Note: Extension rods available for door heights up to 10' (3048 mm).
Device centerline from finished floor	39 13/16" (1011 mm)
Center case	4 5/32" (105 mm) x 3 3/16" (81 mm) x 2 3/8" (60 mm)
Mechanism case	2" (51 mm) x 2 3/8" (60 mm)
Projection	Push bar neutral - 3 11/16" (94 mm) push bar depressed - 2 7/8" (73 mm)
Door undercut	1/4" (7 mm) from finished floor recommended
Latch bolt	Deadlocking anti-friction top and bottom bolt, 5/8" (16 mm) throw
Finishes	526, 622, 689, 695
Fasteners and through bolts (SNB)	Includes screw pack for 1 3/4" (44 mm) and 2 1/4" (57 mm) wood and metal doors; optional SNB available for device (see page 25 for quantities)

Note: Black end caps are standard for all finishes, with the exception of 526. Optional black metal end caps are available; order #900397 as a separate line item. Additional charges apply. All devices configured in 526 finish will be supplied with a metal endcap in 526 finish as standard.

### Minimum door opening chart

Stop height	Strike	Single door	Double door w/mullion	Minimum door opening for 3' device*	Minimum door opening w/ALK*
1/2"	N/A	Yes	Vert. x Vert.	25.875" (657 mm)	32.625" (829 mm)
5/8"	N/A	Yes	Vert. x Vert.	26.000" (664 mm)	32.750" (832 mm)

\* For 4' device, add 6" (152 mm).

### Accessories

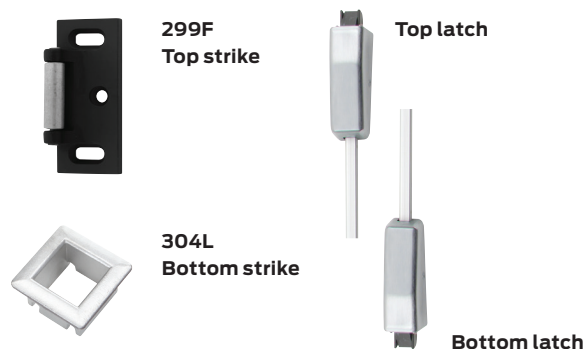

### Features and options

#### Electrified options

<b>ALK</b>	Alarm exit kit
<b>CON</b>	Allegion Connect
<b>LX</b>	Latch bolt monitor switch
<b>LX-LC</b>	Latch bolt monitoring, low current
<b>LX-RX</b>	Latch bolt monitoring, request to exit
<b>LX-RX-LC</b>	Latch bolt monitoring, request to exit low current
<b>RX</b>	Request to exit
<b>RX2</b>	Double request to exit
<b>WP-RX</b>	Waterproof request to exit

#### Mechanical options

<b>GBK</b>	Glass bead kit
<b>HW</b>	Hurricane device - Wind-Only

#### Dogging feature

No mechanical dogging

#### Strikes

**Top – 299F** – (499F LBR) Dull black  
**Bottom – 304L** – Unfinished

## Trim functions

Von Duprin protects your investment by empowering you to adapt with flexible solutions and modular options. The 22 Series features numerous trim options to serve your different needs. Designed with flexibility in mind, our solutions offer ease of adding new options as they are developed.

With Von Duprin, you can be confident that as the needs of your facility change, our products can be upgraded easily to meet your needs, especially as the mechanical and electronic technology converge. Von Duprin’s versatile design enables you to add functionality to existing devices in a cost-effective way, protecting your investment well into the future.

A variety of device trim lock type functions such as key lock and unlock, latch bolt retraction with key and no cylinder designs for an “always operable” function are available in levers, knobs, thumbpiece and thumbturn designs.

	<p><b>EO No outside trim</b></p> <ul style="list-style-type: none"> <li>Exit only</li> </ul>		<p><b>DT Dummy trim</b></p> <ul style="list-style-type: none"> <li>Pull when dogged (not recommended for fire device)</li> </ul>		<p><b>NL Night latch</b></p> <ul style="list-style-type: none"> <li>Key retracts latchbolt</li> <li>Rim and 1 ¼" mortise cylinder</li> </ul>
	<p><b>NLOP Night latch</b></p> <ul style="list-style-type: none"> <li>Key retracts latchbolt, pull required</li> </ul>		<p><b>TP Thumbpiece</b></p> <ul style="list-style-type: none"> <li>Key locks and unlocks</li> <li>Rim and 1 ¼" mortise cylinder</li> </ul>		<p><b>TPBE Thumbpiece, blank escutcheon</b></p> <ul style="list-style-type: none"> <li>Blank escutcheon always operable (no cylinder, use with DT trim)</li> </ul>
	<p><b>L Lever</b> <b>K Knob</b></p> <ul style="list-style-type: none"> <li>Key locks and unlocks</li> <li>Rim and 1 ¼" mortise cylinder</li> <li>Handed, reversible lever</li> <li>Electrified lever operation available</li> </ul>		<p><b>LDT Lever, dummy trim</b> <b>KDT Knob, dummy trim</b></p> <ul style="list-style-type: none"> <li>Pull when dogged</li> </ul>		<p><b>LNL Lever, night latch</b> <b>KNL Knob, night latch</b></p> <ul style="list-style-type: none"> <li>Key retracts latchbolt</li> <li>Rim and 1 ¼" mortise cylinder</li> <li>Handed, reversible lever</li> </ul>
	<p><b>LBE<sup>1</sup> Lever, blank escutcheon</b> <b>KBE Knob, blank escutcheon</b></p> <ul style="list-style-type: none"> <li>Always operable (no cylinder)</li> </ul>				

## Trim options

### No trim



#### Trim description

Nomenclature	EO	110MD-NL* 110WD-NL*
Trim function	No outside trim	Night latch optional pull
Function description	Exit only	Key retracts latch bolt, optional pull required
ANSI function	01	03

#### Device compatibility

22 Rim	■	■
22 Rim-F	■	■
2227	■	■
2227-F	■	■

#### Dimensions

Escutcheon plate size	—	—
Pull center to center	—	—
Projection	—	—

#### Handling

	—	—
--	---	---

#### Cylinder type

Rim or vertical device	—	Rim
------------------------	---	-----

\* ANSI/BHMA A156.3 (2014) Grade 1 trim

#### 110NL cylinder kit

Cylinder kit is available MD for metal doors or WD for wood doors. Metal door application supplied standard if door material is not specified. When ordering with device, specify function NL-OP. Rim Cylinder must be ordered separately.



## Trim options

### 210 trim



#### Trim description

Nomenclature	210DT*	210NL*	210K	210K-BE
Trim function	Dummy trim	Night latch	Knob	Knob-blank escutcheon
Function description	Pull when dogged	Key retracts latch bolt	Key locks and unlocks	Always operable, no cylinder
ANSI function	02	03	08	14

#### Device compatibility

22 Rim	■	■	■	■
22 Rim-F	■	■	■	■
2227	■	■	■	■
2227-F	■	■	■	■

#### Dimensions

Escutcheon plate size	5 <sup>3</sup> / <sub>8</sub> " x 4 <sup>25</sup> / <sub>32</sub> " x <sup>3</sup> / <sub>32</sub> " (137 x 121 x 2 mm)	5 <sup>3</sup> / <sub>8</sub> " x 4 <sup>25</sup> / <sub>32</sub> " x <sup>3</sup> / <sub>32</sub> " (137 x 121 x 2 mm)	3" x 4 <sup>25</sup> / <sub>32</sub> " x <sup>3</sup> / <sub>32</sub> " (76 x 121 x 2 mm)	3" x 4 <sup>25</sup> / <sub>32</sub> " x <sup>3</sup> / <sub>32</sub> " (76 x 121 x 2 mm)
Pull center to center	—	—	—	—
Projection	1 <sup>31</sup> / <sub>32</sub> " (42 mm)	1 <sup>31</sup> / <sub>32</sub> " (42 mm)	2 <sup>15</sup> / <sub>16</sub> " (75 mm)	2 <sup>15</sup> / <sub>16</sub> " (75 mm)

#### Handing

—	—	—	—
---	---	---	---

#### Cylinder type

Rim or vertical device	—	Rim	Furnished	1 <sup>1</sup> / <sub>4</sub> " Mortise
------------------------	---	-----	-----------	---

\* ANSI/BHMA A156.3 (2014) Grade 1 trim

#### 210 Series trim

The 210DT and 210NL have a heavy 10 gauge (2.4 mm) stainless steel escutcheon. Rim cylinder must be ordered separately for the 210NL trim. The 210K knob trim has a 10 gauge (2.4 mm) steel escutcheon and uses the Schlage "A" orbit knob with six pin "C" keyway.

## Trim options

### 230 trim



#### Trim description

Nomenclature	230EO	230DT*	230NL*	230TP-BE*	230TP*	230L*	230L-BE*
Trim function	Exit only plate	Dummy trim	Night latch	Thumbpiece-blank escutcheon	Thumbpiece	Lever	Lever-blank escutcheon
Function description	Exit only plate	Pull when dogged	Key retracts latch bolt	Always operable, no cylinder	Key locks and unlocks	Key locks and unlocks	Always operable, no cylinder
ANSI function	01	02	03	15	05	08	14

#### Device compatibility

22 Rim	■	■	■	■	■	■	■
22 Rim-F	■	■	■	■	■	■	■
2227	■	■	■	■	■	■	■
2227-F	■	■	■	■	■	■	■

#### Dimensions

Escutcheon plate size		3" x 12 1/16" x 3/32" (76 x 306 x 2 mm)			3" x 12 1/16" x 3/32" (76 x 306 x 2 mm)	3" x 6 3/8" x 15/16" (76 x 162 x 24 mm)	3" x 6 3/8" x 15/16" (76 x 162 x 24 mm)
Pull center to center	—	5 1/2" (140 mm)	5 1/2" (140 mm)	5 1/2" (140 mm)	5 1/2" (140 mm)	—	—
Projection	—	2" (51 mm)	2" (51 mm)	2" (51 mm)	2" (51 mm)	2 5/8" (67 mm)	2 5/8" (67 mm)

#### Handing

	—	—	—	—	—	—	—
--	---	---	---	---	---	---	---

#### Cylinder type

Rim or vertical device	—	—	Rim	—	1 1/4" Mortise	1 1/4" Mortise	—
------------------------	---	---	-----	---	----------------	----------------	---

\* ANSI/BHMA A156.3 (2014) Grade 1 trim

#### 230 Series trim

The 230EO, 230DT, 230NL and 230TP have a heavy 10 gauge (2.4 mm) steel escutcheon. The 230L has a cast zinc 3/4" (19 mm) depth escutcheon. Number 06 lever style furnished standard, number 03 and number 17 optional style levers are available. 230L furnished RHR if handing is not specified. Cylinder must be ordered separately for the 230NL, 230TP and 230L trims.

## Electronic locks from Schlage

### AD Series

The AD Series was designed to be the right choice for today, and is ready to adapt to whatever the future holds.

There are a variety of options that allow you to select the AD Series electronic lock that's right for you, and a wide selection of features that can be configured in the field to further customize each opening. When your needs change in the future, the innovative modular design of the AD Series allows you to easily upgrade the credential reader or networking option, and adapt to emerging technologies using your existing chassis – all without taking the lock off the door. This means that you can be confident that your choice of the AD Series is right for today, and that your investment will be protected into the future.



### Credential reader options

AD Series electronic locks are compatible with many different credential types.



- Multi-technology (reads 125 kHz prox, 13.56 MHz smart, NFC mobile)
- Smart - iClass compatible  
+ KEYPAD
- Magnetic stripe (insertion)  
+ KEYPAD
- Magnetic stripe (swipe)  
+ KEYPAD
- Keypad

### Communication options

#### Networked

In facilities where increased monitoring and control are needed, a networked solution is essential. The AD Series networked options feature:

- Open architecture platform
- Reliable 900 MHz communication on wireless locks
- Real-time monitoring

The AD Series networked lock is available in either a wireless or hardwired configuration to fit your application needs.

- **AD-300** Networked hardwired locks
- **AD-302** Networked hardwired FIPS 201-2 APL Listed locks
- **AD-400** Networked wireless locks
- **AD-402** Networked wireless FIPS 201-2 integration-ready locks

### Standalone

Standalone locks are a cost-effective solution for doors that do not require real-time monitoring.

The AD Series standalone solution provides:

- Option for future upgrade to networked wireless
- Improved credential management
- Audit trail reports

Schlage offers two AD Series standalone solutions to fit your environment:

- **AD-200** Access rights are stored on the lock
- **AD-250** Access rights are stored on the magnetic stripe credential

### Chassis

- Cylindrical
- Mortise
- Mortise deadbolt
- Exit trim<sup>1</sup>

### Locking functions<sup>2</sup>

- Classroom/storeroom
- Office
- Privacy
- Apartment

### Certifications

- ANSI/BMHA A156.25
- ANSI/BHMA Grade 1
- UL 294 listed
- UL 10C
- ADA
- FCC part 15
- RoHS

### Complete your system

Complete your AD Series system with readers, credentials, system components, and other wireless accessories.

1. See [AD Series exit trim compatibility data sheet](#) for complete list of compatibility by manufacturer.
2. Lock function capability varies depending on Physical Access Control Software (PACS) OEM integration design.

### CO Series

In the world of standalone electronic locks, CO Series offers simple solutions for access control. These easy-to-use, versatile locks can be applied anywhere there is a need to control access without distributing keys. The popular CO-100 is a simple lock that momentarily unlocks with a valid PIN code entry. It can be used indoors or out and allows administrators a variety of command options. The Series also includes CO-200, the CO-220 classroom lock, and the CO-250. These computer programmable locks can provide audit trails and feature dual credential options (card+PIN) that provide an even greater level of security.



### Compatibility

The CO Series offers a wide range of applications and can be used alongside other Schlage electronic locks. They feature expanded cylinder, exit device, and credential compatibility.



## Trim options

# Electronic locks from Schlage

### Exit device compatibility<sup>1</sup>

	Rim	SVR <sup>2</sup>	CVR/CVC	Mortise
Von Duprin 22/22F	AD/CO	AD/CO	AD	AD

1. CO-220 is not compatible with surface vertical rod (SVR) devices.

#### Notes:

See [AD Series](#) and [CO Series](#) exit trim compatibility data sheets for complete list of compatibility by manufacturer.

Exit device must be ordered as Exit Only (EO).

### Class

#### CO-100

- Manually programmable
- Keypad only
- User rights stored on the lock
- Remote release, outdoor use and occupancy indication options

#### CO-200

- Computer or manually programmable
- Keypad, magnetic stripe (+PIN), proximity (+PIN)
- User rights stored on the lock
- Ability to provide schedules and audits

#### CO-220

- Computer or manually programmable
- Keypad, magnetic stripe (+PIN), proximity (+PIN)
- User rights stored on the lock
- Ability to provide schedules and audits
- Classroom lockdown function via fob

#### CO-250

- Computer programmable
- User rights stored on the card
- Magnetic stripe (+PIN)

#### Chassis

- Cylindrical
- Mortise
- Mortise deadbolt
- Exit trim

#### Functions

- Classroom/storeroom
- Office
- Privacy

#### Power

- 4 standard (AA) batteries

#### Reliability

When it comes to securing your facility, you can't afford to take chances. CO Series locks are tested to the highest quality and reliability standards in the industry, including:

- ANSI/BHMA A156.25 and ANSI/BHMA Grade 1
- UL 294
- UL 10C
- ADA

## Lever styles and finishes for Schlage AD and CO Series

### Lever options

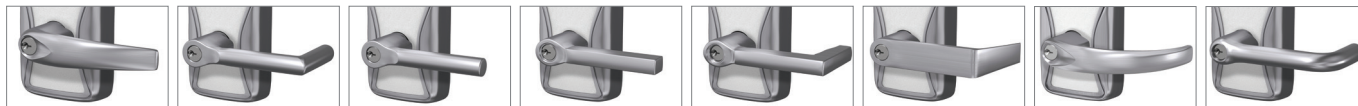

Athens

Boardwalk

Broadway

Latitude

Longitude

Rhodes

Sparta

Tubular

### Finish options

Color	Bright brass	Satin brass	Satin bronze	Satin nickel	Bright chrome	Satin chrome	Aged bronze
ANSI/BHMA number	605	606	612	619	625	626/626AM	643e

## Mechanical options

### Dogging options

#### Less dogging (LD)

Less dogging is available on all 22 Series panic exit devices to remove the dogging option.

**To order, specify:** Use prefix LD, example LD22EO.

#### Dog keys

##### 227 Dog key (standard)

← 2 3/4" (70 mm) →

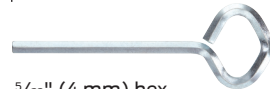

5/32" (4 mm) hex

##### 222 Dog key (old style)

← 2 3/16" (56 mm) →



7/32" (6 mm) hex

### Accessibility options

#### Accessible device (AX)

The AX device is a UL certified exit device designed to meet the progressive requirements of the California Building Code for accessible openings. This device meets the 5 lbs of operating force requirement called for in chapter 11B-309.4. The AX device also exceeds ANSI/BHMA requirements. Available devices include: AX22, AX22-F, AX2227LBR, AX2227-F LBR. Additionally, all AX devices will be shipped with a UL label clearly stating "Meets California building Code (2013) Sec. 11B-309.4" and an "AX" identifier label on device center case. See image for reference.



### Latches

#### Less bottom rod (LBR)

LBR option is available for panic and fire rated devices. For each pair of LBR fire rated devices, a spring loaded auxiliary fire bolt is furnished and must be installed in the lower door edge. When exposed to heat the auxiliary fire bolt releases, keeping the doors in alignment and closed during a fire.

LBR fire rated devices must be ordered in pairs or must be used in conjunction with an approved automatic or constant latching flush bolt. See UL fire chart for listing details on page 26.

#### Pullman latch (PL)

When PL is specified the standard latches are replaced at additional cost with pullman style latches. Pullman latches are most commonly used in conjunction with electric strikes and LBR applications. Not available with fire rated devices.

Not recommended where security is of the utmost importance since latches do not deadlock.

## Mechanical options

### Hurricane rated devices

Hurricane resistant openings are designed to withstand storm conditions for long periods of time while maintaining functionality.

**Wind-Only (HW)** hurricane devices are ideal for applications with lower hurricane requirements such as inland regions with only high wind pressure posing a threat. Wind-Only hurricane devices are tested for structural integrity in accordance with ASTM E330 for Wind-Only applications.

**Wind and Impact (HH)** rated hurricane device requirements are more stringent than Wind-Only applications. Wind and Impact devices are subject to tests for both wind speed and flying debris in accordance with Florida Building Code (HVHZ), TAS 201, 202, 203 and ASTM E1886, E1996, E330 protocols. If the hurricane application is unknown, specify HH (Wind and Impact) product, which also satisfies Wind-Only applications. **Not all device series are available with HH option.**

Hurricane rated exit devices must be paired with Allegion approved doors and hurricane rated mullions, if applicable. Specify mullions with HW or HH prefix.

#### Other resources:

[Von Duprin Hurricane Reference Sheet](#)

[Allegion Windstorm Solutions Brochure](#)

**Von Duprin 22 Series devices are only available with Wind-Only (HW) option**

Many hurricane rated devices use standard device components. Devices will be furnished with the proper strikes and components if HW is specified. Pricing will be adjusted accordingly.

#### To order, specify:

1. Prefix HW for Wind-Only.
2. Model number and description.
3. Door mode: SGL (single) or PR (pair).

**Example:** HW22NL-F 3' 628 PR

#### 22 Series hurricane device/strike application chart

Application	Model	Single door	Double door	
		Standard strike	Mullion	Standard strike
HW (Wind-Only)	22	299	4954 or KR4954	299
			1654 or KR1654	1606
			5654	299
			5754	1408
	22-F	299F	9954 or KR9954	499F
	2227	Top: 299 Bottom: 304L	-	Top: 299 Bottom 304L
	2227-F	-	-	Top: 299F Bottom 304L

Note: Hurricane rated exit devices for use when paired with Allegion approved doors.



## Switches

### Request to exit (RX)

The RX feature is used to signal the use of an opening. This device is equipped with one internal SPDT switch which monitors the push pad. The device can be connected to a security console, or may be used as a single door alarm when used with a horn and power supply. The RX switch option should not be used to control a load, but as a signalling switch (2 amps resistive maximum). The RX switch is available in a low current (LC) 50ma max. Most commonly used to signal low-current access control inputs.

**To order, specify:**

- Standard – use prefix RX, example RX22EO
- Low Current – use prefix RX-LC, example RX-LC22EO

### Double request to exit (RX2)

The RX2 feature uses two RX switches.

**To order, specify:**

- Standard – Use prefix RX2, example RX2 22EO

### Waterproof request to exit (WP-RX)

Switch rated to IP67 – protected from contact with harmful dust and from immersion in water with a depth of up to 1 meter (3.3 feet) for up to 30 minutes.

Note: All in-field electrical connections should be in compliance with IP67 to ensure trouble free operation.

### Latch bolt monitoring (LX)

The LX feature is used to signal the use of an opening. This device is equipped with one internal SPDT switch which monitors the latch bolt.

The device can be connected to a security console, or may be used as a single door alarm when used with a horn and power supply.

The LX switch option should not be used to control a load, but as a signalling switch (2 amps resistive maximum).

The LX switch is available in a low current (LC) switch. Most commonly used in computer operated monitoring systems.

**To order, specify:**

- Standard – Use prefix LX, example LX22EO
- Low Current – Use prefix LX-LC, example LX-LC22EO

**Electrical rating for all switches:**

- Standard – 2 amp maximum @ 24VDC
- Low Current (LC) - below 50 Milliamps @ 24VDC

Note: All switches can be either factory or field installed.

## Alarm kit

Alarm kit (ALK) is a simple yet effective way to deter unauthorized use of an opening. While the exit device is still a means of egress, the ALK kit contains an internal horn. When the touch bar is depressed, the horn sounds to provide an audible means of signaling that the opening has been violated. The alarm kit can be armed or disarmed by key thus allowing the exit device to be set in an armed or disarmed mode. The horn is rated at 85 decibels.

**For hardware applications**

The assembly includes both a 24VDC Input and External Inhibit standard. The External Inhibit provides remote arming and dis-arming.

The key switch uses a standard 1 1/4" (32 mm) mortise cylinder with a straight cam (Schlage 20-001, L583-477 cam). The unit operates on one standard 9-volt alkaline battery, or can be hardwired to PS902 power supply. When the battery is weak, the horn will emit an intermittent low battery alert signal.

Auto reset (AR) option is standard with this kit. This allows the device to resume the alarm option after a preset time. Preset times can be field selected at 1.5, 3, or 4.5 minutes.

Alarm kits are available with a choice of two switch kits, RX or LX. RX monitors the touchpad and is furnished standard. LX optional latch bolt monitoring is recommended for use with surface vertical rod exit devices or when alarm needs to sound from both the exit device and trim side of the door. Specify ALK-LX.

The ALK includes a 6" x 20" decal for application on door "EMERGENCY EXIT ONLY. ALARM WILL SOUND."

**To order, specify:**

1. Standard, 22 ALK

**Minimum door opening sizes on ALK applications**

Refer to device pages.

## Electrified options

### Electrical power transfers

#### Electrical power transfer (EPT)

Electric power transfer provides a means of transferring electrical power from a door frame to the edge of a swinging door. The units are completely concealed when the door is in the closed position, and are ideal for installations involving abuse or heavy traffic.

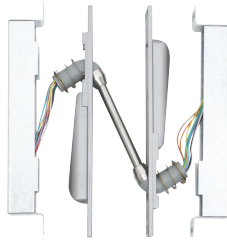

Two models are available; EPT-2, two 18 gauge wires and EPT-10, ten 24 gauge wires. The EPT-2 and EPT-10 are UL listed as “miscellaneous door accessory”. UL Listed for use on fire doors.

#### Finishes

- 689 Powder Coated Aluminum
- 695 Powder Coated Dark Bronze

### Allegion Connect

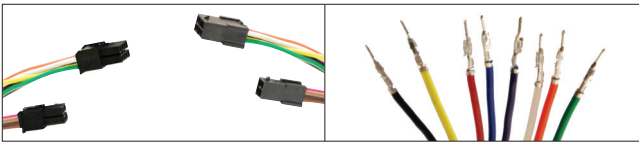

Allegion Connect features common interconnect components for many cross-category electrified options. Allegion Connect is a quick and easy way to connect power sources. There is no wire cutting; reducing installation and maintenance time ultimately cutting cost. After installation, Allegion Connect continues to provide benefits throughout the lifetime of the opening by offering a service kit for repairs or modifications in the future.

#### Features and benefits

- Quick: common connections reducing installation time
- Perfect connections: these factory installed connectors ensure the right wires match up every time
- Protective: the connectors protect the connection points throughout the installation process and lifetime of the opening
- Interchangeable: all Allegion Connect products utilize the same connectors
- Maintenance: you no longer need to cut away wire to disconnect Allegion products, also available is a service kit specifically for Allegion Connect products.

#### Door applications

Degree of opening	Hinge type	Door thickness
0-180	Up to 5" butt hinges	1 3/4"
0-180	Up to 3/4" offset pivots	1 3/4"
0-130	5 1/2" butt hinges	1 3/4"
0-110	6" butt hinges	1 3/4"
0-90	Swing clear hinges	1 3/4"

#### Dimensions

Housing	9" x 1 1/4" x 1 5/8" (229 mm x 32 mm x 38 mm)
EPT-2	Two 18 gauge wires, Up to 2 amps @ 24VDC, with a 16 amps maximum surge
EPT-10	Ten 24 gauge wires, Up to 1 amps @ 24VDC, with a 16 amps maximum surge

#### To order, specify:

1. EPT-2, EPT-10
2. Finish, 689 or 695

Harness length	Connectors on both ends	Connectors on one end, crimped pins on the other end
6 Inches	CON-6	CON-6P
12 Inches	CON-12	CON-12P
26 Inches	CON-26	CON-26P
32 Inches	CON-32	CON-32P
38 Inches	CON-38	CON-38P
44 Inches	CON-44	CON-44P
50 Inches	CON-50	CON-50P
192 Inches	CON-192	CON-192P

Power supply wire harness = connectors on one end, stripped leads on the other end.

6 Inches	CON-6W - wire extension to field wiring
----------	---

Consult door manufacturer for harness length requirements.

**Note:** You will need to purchase a separate wiring harness to go from exit device to hinge/EPT and an additional harness to go from hinge/EPT to field wiring. Harness part numbers with ordering information can be located in the Schlage, Von Duprin and Falcon pricebooks. A service kit is available for order in the Schlage, Von Duprin and Falcon pricebooks. Included in this kit are male end plugs, female end plugs and pins to customize harnesses to your application.

**Note:** Must be ordered with exit devices and locks

#### To order, specify:

1. Specify CON for Connect electronic options  
Example: RX-22-EO-CON  
(22 Series with RX switch and Connect connectors)
2. Specify harness length; Consult door manufacturer for harness length
3. Specify Von Duprin EPT10-CON or Ives electrical thru-wire CON hinge or pivot

#### Wire run options

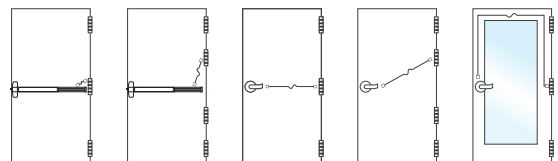

# Strikes

## Strikes for rim devices

264

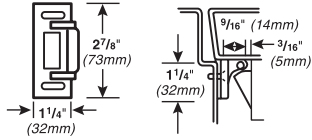

Projection 9/16" (14 mm)

299

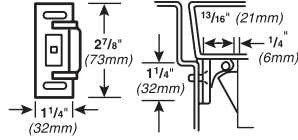

Projection 1 3/16" (21 mm)

299F

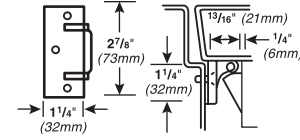

Projection 1 3/16" (21 mm)

499F

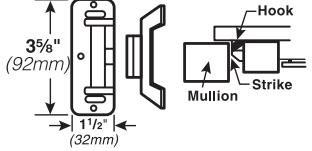

Projection 1 5/16" (24 mm)

1408

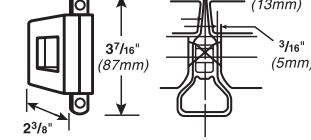

- Used with 5754 mullion
- One per pair of doors

1439-Blade stop

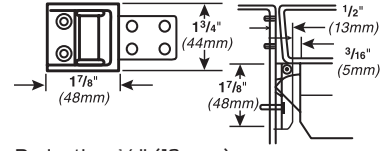

Projection 1/2" (13 mm)  
Note: Replaces 1409 strike

1410-Integral stop

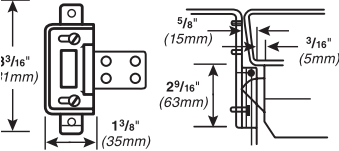

Projection 1/2" (13 mm)

1606

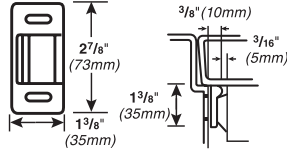

Projection 3/8" (10 mm)

1609

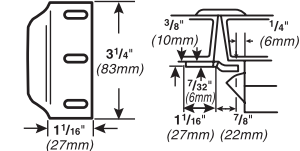

- Requires coordinator
- For panic exit application only, not fire rated

## Strikes for vertical rod devices

248L-4

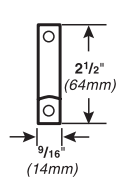

Projection 3/8" (10 mm)

260U-Flush transom only

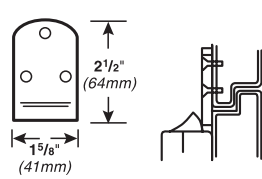

Projection 3/8" (10 mm)

304L

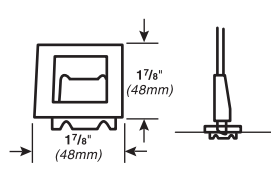

Projection 1 3/16" (21 mm)

385A

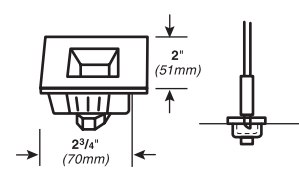

Projection 1 3/16" (21 mm)

Note: Strikes 264, 299, 299F and 499F also available for vertical rod devices.

# Cylinders

Cylinders are not furnished with device or trim and must be specified when ordering. Refer to trim pages for cylinder type.



**Mortise — 3215**  
(Schlage 20-001,  
L583-477 cam)



**Rim — 3216**  
(Schlage 20-022)

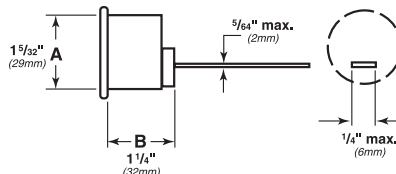
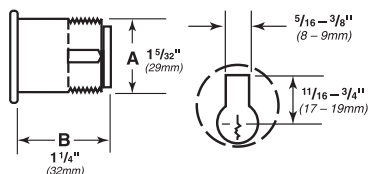



## Accessories

### Door kits

#### Vertical rod and latch guard (RG-27)



Series RG-27 Vertical rod and latch guards protect the bottom rods of exit devices from the damaging impacts of carts or gurneys passing through doors. (If bottom rods become damaged, the exit device will not function as intended and can jeopardize the ability to exit safely during an emergency.)

In addition to protecting the vertical rod, the guard provides a smooth, unobstructed surface so the door can be pushed open easily with the bumpers of a wheelchair. The latch guard portion is 10" high. The standard latch guard features a 45° ramp. The extended latch guard offers a continuous ramp for 3' or 4' doors.

All stainless steel construction in 630 finish. Latch guards can cover latches as large as 1 1/4"W x 10"H x 1 7/8" projection.

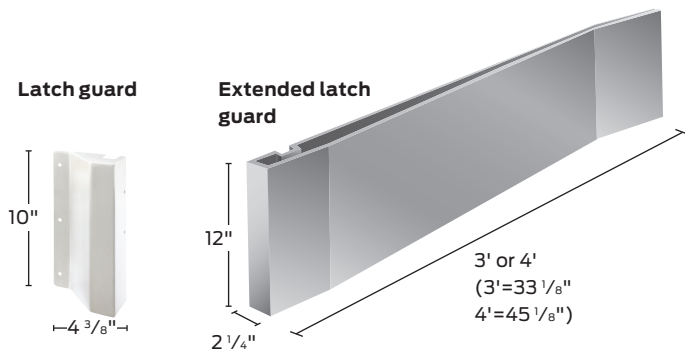

#### Models

RGO	Rod guard only (projection 1 3/16")
RG-27	Rod and latch guard
RG-27-3	3' (914 mm) Rod guard and extended latch guard
RG-27-4	4' (1219 mm) Rod guard and extended latch guard
LGO	Latch guard only
LGO-3	3' (914 mm) Extended latch guard only
LGO-4	4' (1219 mm) Extended latch guard only

When using on wood fire doors, high density block is required.

#### To order, specify:

1. Model number.\*
2. Handing (except on RGO).
3. Door material if other than hollow metal.
4. Optional through bolt mounting available.

\* RGO/RG-27 includes one rod guard only, which accommodates bottom or top rod up to 7' door. For longer top rods, specify rod guard quantity required.

#### 229 Cover plate kit

Cover plate kit contains inside and outside plates for hinge stile cutouts, an inside plate for the lock stile, and necessary screws. Plates are designed to cover cutouts required by most existing exit device installations.

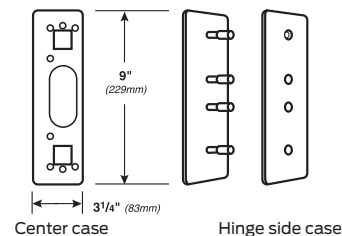

#### Glass bead kit (GBK)

Glass bead conversion kits are available for all 22 Series devices for use on doors with raised glass beads. Each kit consists of 1/4" (6 mm) shim sets. GBK for surface vertical rod ships with 1/8" shims for rod guides.

- 2 stacked kits maximum for panic hardware
- 1 kit maximum for fire hardware
- Shim thickness + door thickness not to exceed 2 1/4"

#### To order, specify:

1. Device model.
2. GBK.
3. Device type (rim or surface rod).
4. To order separately, specify model 22GBK-R (rim), 22GBK-499F (rim), 22GBK-SV (vertical rod).
5. Finish.

**Example:** 22 GBK Rim 689

## Through bolts

Through bolts provide secure mounting by mating with machine screws furnished with devices. Through bolts are either optional or required, as shown in quantity chart below. Through bolts ordered separately are not furnished with screws. If screws are required, order device mounting packages.

An alternative to through bolt mounting is the use of UL or WH approved high density blocking material for wood fire rated doors. Specify device with SLM (special laminate material) mounting package.

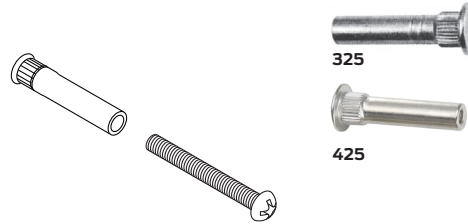

### To order through bolts:

1. If ordering devices with through bolts, specify SNB (through nuts and bolts) in device description.
2. If ordering through bolts separately, specify:
  - Through bolt model number
  - Package quantity (sold as package of 2)
  - Finish

Device type	Door type	Door mode	Function	Through bolts				
				425		325 for 499 hook		325 for latches
				Required Added to device price	Optional Added to device price	Required Added to device price	Optional Added to device price	Required Added to device price
22 Rim	All		EO, NL-OP		6			
	All		DT, K, L, NL, TP		2			
22 Rim-F	Metal	SGL	EO, NL-OP		6			
	Metal	SGL	DT, K, L, NL, TP		2			
	Metal	PR	EO, NL-OP		6		2	
	Metal	PR	DT, K, L, NL, TP		2		2	
	Wood	SGL	EO, NL-OP	6				
	Wood	SGL	DT, K, L, NL, TP	2				
	Wood	PR	EO, NL-OP	6		2		
	Wood	PR	DT, K, L, NL, TP	2		2		
2227	All		EO, NL-OP		6			4
	All		DT, K, L, NL, TP		2			4
2227 LBR	All		EO, NL-OP		6			2
	All		DT, K, L, NL, TP		2			2
2227-F	Metal		EO, NL-OP		6			4
	Metal		DT, K, L, NL, TP		2			4
	Wood		EO, NL-OP	6				4
	Wood		DT, K, L, NL, TP	2				4
2227-F LBR	Metal		EO, NL-OP		6		2	2
	Metal		DT, K, L, NL, TP		2		2	2
	Wood		EO, NL-OP	6		2		2
	Wood		DT, K, L, NL, TP	2		2		2

## Accessories

### Mullions

Removable steel mullions provide single door performance in double door openings with rim devices. Mullions are easily removed by loosening bottom set screw and removing top fitting cover. The top mullion fitting is attached to the frame and is concealed by the fitting cover.

- Steel mullions are 2" (51 mm) wide and 3" (76 mm) deep, with a wall thickness of  $\frac{1}{8}$ " (3 mm)
- Mullions are shipped with mounting screws and prepared for strikes (strikes are not included except where indicated)
- Steel mullions are available in SP28 and SP313 finishes (Consult factory for other powder coat finish options)

#### Keyed removable steel mullions (KR)

KR mullions make removal faster and easier by a single operation of the mortise cylinder. Once mullion is removed, large equipment or furniture can freely pass through the opening. The unit will self lock when re-installed, without the use of the cylinder key. Uses a  $1\frac{1}{4}$ " mortise cylinder with a straight cam (Schlage cam reference L583-477). Cylinders are sold separately. Prefix mullion model with "KR".

Removable aluminum mullions are  $1\frac{1}{16}$ " (27 mm) wide on face closest to the door and  $2\frac{3}{8}$ " (60 mm) at the widest point. The depth is  $3\frac{1}{8}$ " (79 mm) with a wall thickness of  $\frac{1}{8}$ " (3 mm).

Aluminum mullions are available in 606, 612, 628, 710 and 622/711 finishes. Consult factory for other powder coat finish options. Aluminum mullions are not available keyed removable.

Stock hollow metal applications for devices mounted to cover ANSI 161 cutouts are higher than the standard mullion strike location. Consult the factory for special strike preparation or order a blank mullion. See below.

#### Blank mullions

are furnished without strike preparation. They are used to mount devices at a strike height different from the standard mullion preparation.

#### To order, specify:

1. For keyed removable option on steel mullions, prefix model number with "KR"
2. Model number
3. Height of opening
4. Finish
5. Handing if required
6. Centerline deviation (refer to device template for standard centerline)
7. Strikes, when required, should be ordered with device

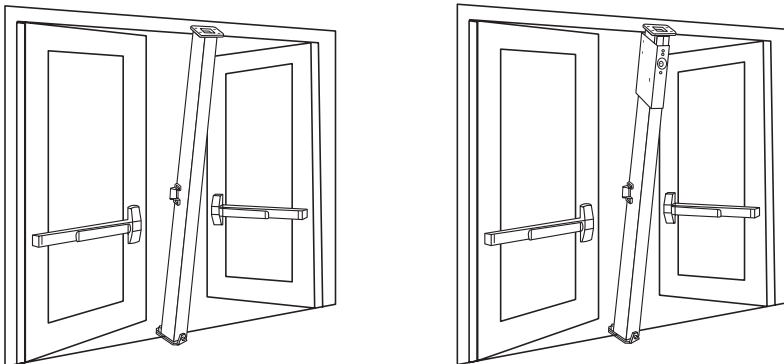

## Steel and aluminum mullions

### Steel mullions

- 1654** Prepared for two 1606 strikes. If 1606 strikes are not specified on the order, two per mullion will be added. Additional charges apply.
- 4954** Prepared for 264 or 299 strikes. For use with all Von Duprin Panic rim devices.
- 9954**  Prepared for and must be used with two 268 strikes (88-F device), or two 499F (22-F, 98-F, 99-F devices). UL fire labeled mullion for up to 3 hour opening using Von Duprin fire exit rim devices. This mullion is not easily removed due to special fittings. 98-F and 99-F devices are rated up to 10'0" (3048 mm).

Note: If 268 or 499F strikes are not specified on the order, two per mullion will be added. Additional charges apply.

- 4754** Prepared for two 4263 monitor strikes.
- 4854** Prepared for one 299 and one 6111 electric strike. Indicate handing for electric strike.
- 9854**  Prepared for one 268 or 499F strike and one 6111 electric strike. Indicate handing for electric strike. UL fire labelled mullion for up to 3 hour openings up to 8' x 8' (2438 mm x 2438 mm) using Von Duprin fire exit rim devices

### Aluminum mullions

- 5654** Prepared for two 299 strikes.
- 5754** Prepared for 1408 double strike.

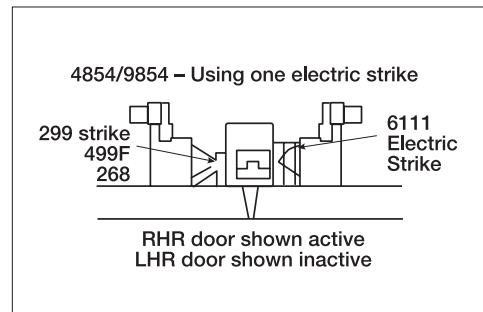
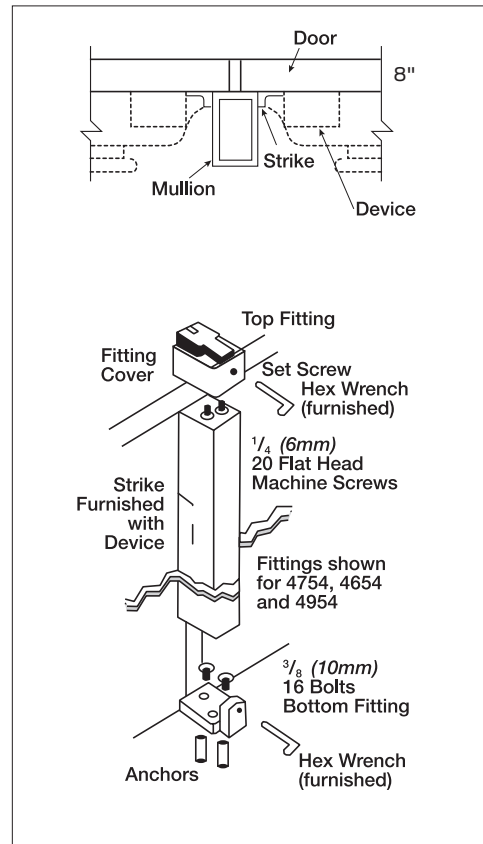



## Additional information

# UL Listing for fire exit hardware

## UL Listed fire exit hardware label and opening size

			With mullion	V x V same direction	V x V double egress
22-F	Metal, wood core, composite (wood or plastic covered)	3 Hour 4' x 8'	3 Hour 8' x 8'		
2227-F	Metal, wood core, composite (wood or plastic covered)	—		3 Hour 8' x 10'	3 Hour 8' x 10'
2227-F-LBR	Metal, wood core, composite (wood or plastic covered)	—		3 Hour 8' x 8'	3 Hour 8' x 8'

Note: Check with door manufacturers to confirm listing compatibility.

## Function, grade and type options

Function	Grade 1, type 1	Grade 1, type 2
01	22EO / 22EOF	2227EO / 2227EO-F
02	22DT	2227DT
03	22NL / 22NL-F	2227NL / 2227NL-F
05	22TP / 22TP-F	2227TP / 2227TP-F
08	22K / 22K-F	2227K / 2227K-F
08	22L / 22L-F	2227L / 2227L-F
14	22K-BE/22K-BE-F	2227K-BE/2227K-BE-F
14	2227K-BE/2227K-BE-F	2227L-BE/2227L-BE-F
15	22TP-BE/22TP-BE-F	2227TP-BE/2227TP-BE-F

## Dimensions

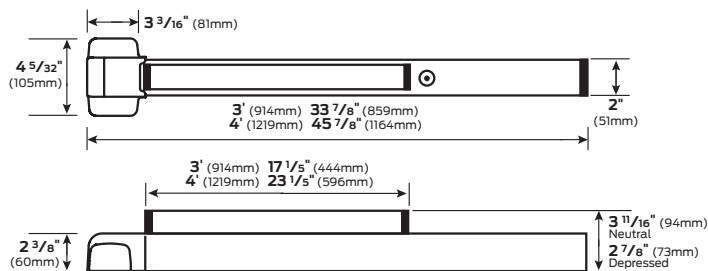

## Vertical rod dimensions

Vertical rods are  $\frac{1}{2}"$  (13 mm) square tubing

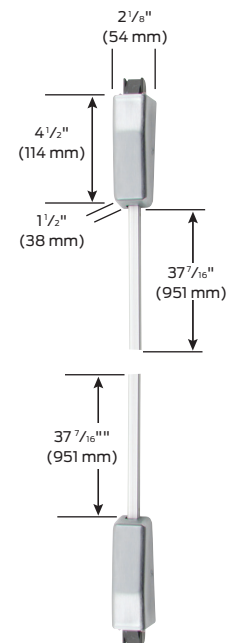

**Additional information**

## Minimum stile information

Device type	Standard single door		Standard double door		Optional single door		Optional double door	
	Strike	Stile	Application <sup>1</sup>	Stile	Strike	Stile	Application <sup>1</sup>	Stile
22	299	4 3/8" (121 mm)	299 x 4954	4 3/4" (121 mm)	1439	3 13/16" (97 mm)	299 w/5654	4 1/4" (108 mm)
					1410	3 13/16" (97 mm)	1408 w/5754	3 13/16" (97 mm)
					1606	3 15/16" (100 mm)	1606 w/1654	4 1/4" (108 mm)
					—	—	1609 with vertical rod <sup>2</sup>	4 3/8" (111 mm)
22-F	299F	4 3/8" (111 mm)	499F x 9954	4 7/8" (124 mm)	—	—	—	—
2227 Latch retraction	299 (Top) 304L/248L (Bottom)	3 5/8" (92 mm)	Two vertical rods	3 5/8" (92 mm)	260U Top 385A Bottom	3 5/8" (92 mm)	Two vertical rods	3 5/8" (92 mm)
2227 Pullman latch	299 (Top) 248L (Bottom)	3 5/8" (92 mm)	Two vertical rods	3 5/8" (92 mm)	260U Top	3 5/8" (92 mm)	Two vertical rods	3 5/8" (92 mm)
2227-F	299F (Top) 304L (Bottom)	3 5/8" (92 mm)	Two vertical rods	3 5/8" (92 mm)	260U-SS Top	3 5/8" (92 mm)	Two vertical rods	3 5/8" (92 mm)

- Mullion information, refer to General and Auxiliary catalogs.
- Not for UL fire exit hardware. Must be used with a coordinator.

Note: On a rim/vertical rod application for a pair of doors, the 1609 strike extends off the edge of the door into the opening.

## Lever styles and finishes

### Standard levers



**03**



**06 (Default lever)**



**17**

Finish options				
Color	Powder Coated Chrome	Powder Coated Aluminum	Powder Coated Matte Black	Powder Coated Dark Bronze
ANSI/BHMA number	526	689	622	695



## About Allegion

Allegion (NYSE: ALLE) is a global pioneer in seamless access, with leading brands like CISA®, Interflex®, LCN®, Schlage®, SimonsVoss® and Von Duprin®. Focusing on security around the door and adjacent areas, Allegion secures people and assets with a range of solutions for homes, businesses, schools and institutions. Allegion had \$2.7 billion in revenue in 2020, and its security products are sold around the world.

For more, visit [www.allegion.com](http://www.allegion.com)

KRYPTONITE ■ LCN ■  ■ STEELCRAFT ■ VON DUPRIN