



T R I T O N

USER MANUAL



WWW.TRITONKEYMACHINE.COM



TRITON



PLEASE FOLLOW THESE INSTRUCTIONS WHEN USING YOUR TRITON™ KEY CUTTER:

- 1** The equipment is designed to be operated at DC24V. The machine will only operate normally at 24VDC. Low/high voltage can harm the machine motor.
- 2** The cutter should be replaced on a regular basis. Delayed replacement or using a dull cutting bit can lead to inaccurate key cutting.
- 3** The cutting accuracy of the machine depends on the material type of the key blank. Select correct speed and cutting times to cut hardened key blanks.
- 4** Be sure to mount the machine on a solid secure surface. Clean the machine with a brush only. Prevent any kind of water intrusion when cleaning.
- 5** Make sure to enter correct key data and input correct key bitting number.
- 6** When using a voltage inverter to run the machine off a vehicle, always leave the vehicle running when using the machine.

CONTENTS



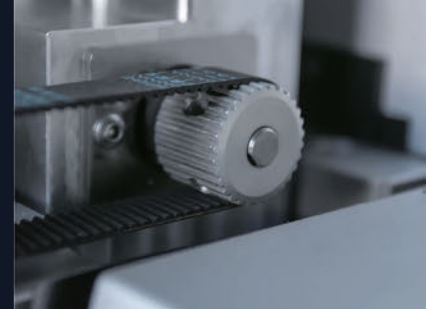

PAGE

Safety	4
Power Safety.....	4
Installation Safety.....	4
Usage Safety.....	5
Additional Safety Notes.....	5
Parts	6-7
Part Names	8-9
Power Adapter	10
Specifications	11
Consumable Items	12-13
Cutter.....	12
Decoder.....	13
Key Clamping	14-17
Jaw Instructions	18
S1 Jaw.....	15
S2 Jaw.....	16
S3 Jaw.....	16
S4 Jaw.....	17
Standard Menu	19-21
Jaw Calibration	22-29
Search	30-31
Key Blank Search.....	30
IC Card Search.....	31
Settings Menu	32-36
Language.....	32
Software Upgrade.....	33
Cutting Speed.....	34-35
About Us.....	36
Key Decoding	37
Key Cutting	38-39
Cutting Depth Adjustment	40-41
Layered Cutting	42-43
Move	44-45
Code	46-47
Progression	48-49
Duplicate	50-55
Single Standard Key.....	50
Double Standard Key.....	51
Single External Groove Key.....	52
Double External Groove Key.....	53
Internal Groove.....	54
Tubular Key.....	55
Custom Keys	56-71
Favorites	72
Cut History	72
Wifi Connection	73
Software Activation	74
Warranty	75









SAFETY



Safety Instructions

-  Make sure to observe the following for using the equipment safely;
 -  The information below is provided to enhance the user security awareness and prevent property loss. Read the safety precautions carefully for correct use.
-  Indicates that you could be injured or damage the equipment if you fail to follow the instructions.
-  Indicates that you can be seriously injured if you fail to follow the instructions.





Power Safety

-  Never use damaged power cords or loose plugs/ sockets.
-  Do not overload power plugs. Only use outlets rated for the machine load.
-  Never pull out the plug by tugging the power cord. Remove plug from socket by pulling directly on plug.
-  Keep the equipment unplugged when not in use.
-  If the machine makes any unusual noise when in use, turn off immediately and disconnect the power right away. Then contact your dealer or our factory for advice.
-  If you are using the machine with an inverter, a 10 amp fuse is required. The vehicle should be running while the machine is in use



Installation Safety

-  Do not install the equipment in a place with oil, dirt, moisture, dust or water intrusion as it may cause electric shock or fire.
-  Do not install near any heat source. This may cause machine overheating and failure.
-  Make sure to install the equipment on stable flat surface. The equipment weighs 35 lbs and generates minor vibration during operation. If you use the equipment on rough surface, it may lead to damage to equipment/worktable.







Usage Safety

-  The machine cutting bit spins at high speed during operation. Keep your body, clothing and loose items away from the equipment when in use to prevent injury.
-  Keep cutting vise and machining area clear at all times. Do not place any objects in this area.
-  Placing foreign objects in the cutting area must be avoided to prevent potential injury to machine operator.
-  Overheating or incorrect voltage may lead to fire or equipment failure. Water intrusion could lead to electrical shock.



Additional Safety Notes

-  Do not disassemble or modify the equipment. It may cause fire, electric shock and equipment failure. If you need a check-up, adjustment or repair of the equipment, please contact your dealer for repairs.
-  Keep children away from the equipment. This machine is designed for adult operation only.
-  In winter (sub-zero temperatures), the equipment will not work properly. Increase the temperature of working environment to 32 F or above for proper operation.

Parts

Name	Picture	Quantity	Purpose
Cutter		2ea	Key cutting tool
Decoder		2ea	Key decoding tool
2.5mm T-wrench		1ea	Tightening M5 bolts
1.5mm T-wrench		1ea	Tightening M3 bolts
M5 Bolt		2ea	Fixing cutter and decoder
M3 Bolt		2ea	Fixing keys on Side C/D of 4-way jaw
Stopper and Calibration Block		1ea	Calibrating jaws and guiding key reference position

Parts

Name	Picture	Quantity	Purpose
24V Adaptor w/Power Cord		1ea	Power supply INPUT 100~240V 50/60Hz 2A OUTPUT 24V 5A
Brush		1ea	Cleaning debris and shavings
Product Manual		1ea	User Manual

Part Names



Part Names

(continued...)

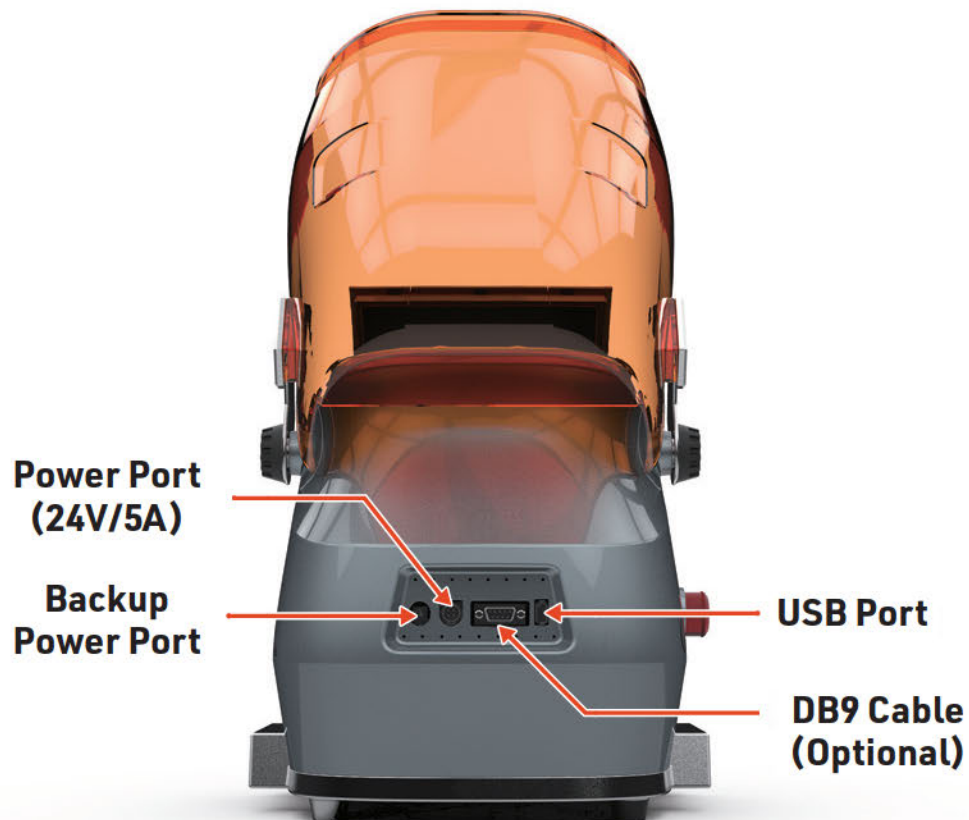

⚠ ATTENTION

- Avoid touching screen with sharp objects, it is easily damaged.
- Decoder is a consumable item, replace when damaged.
- Handle decoder with care to avoid damaging.
- Triton™ is not responsible for decoder damage in any case.

Power Adapter

Accessories/Components for Power



Power Switch

Turn On (Twist Clockwise)



Turn Off (Press)



Connect the power adapter. Rotate switch clockwise to turn on the equipment. Depress switch to turn off the equipment.

Equipment Specifications

Power Input	
Voltage	DC24V/5A
Power	120W
Size	305(W) x 300(H) x 400(D)mm
Weight	35.3 lbs
Accuracy	XY Axis:0.0025mm Z Axis:0.0025mm
Spindle Speed	12000+rpm
Working Temperature Range	0-104°F
Working Humidity Range	10-90%
Usage	To cut automobile keys, residential keys, motorcycle keys, dimple keys, tubular keys, FO21 tibbe keys.

Consumables

Cutter

- 1.1 Installation
- 1.2 Disassembly

1.1 Installation

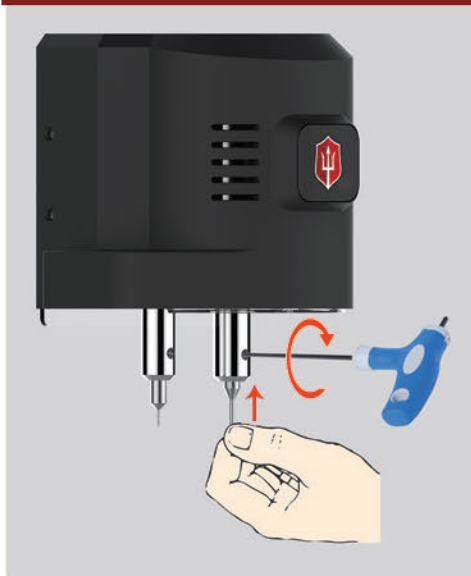

Steps for Cutter Installation:

1. Insert the cutter into the cutter holder and push it all the way in until it stops.
2. Tighten M5 screw tightly by turning 2.5mm T-wrench clockwise.

1.2 Disassembly

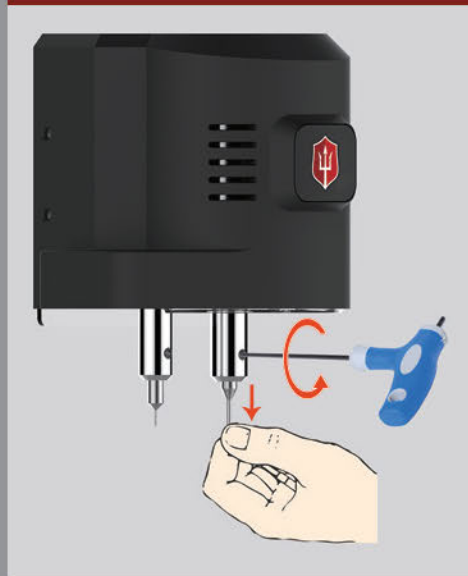

Steps for Cutter Disassembly:

1. Hold the cutter and loosen M5 screw by turning 2.5mm T-wrench counterclockwise.
2. Remove the cutter.

Consumables

(continued...)

Decoder

- 2.1 Installation
- 2.2 Disassembly

2.1 Installation



Steps for Decoder Installation:

1. Insert the decoder into the cutter holder and push it in until it stops.
2. Tighten M5 screw tightly by turning 2.5mm T-wrench clockwise.

2.2 Disassembly

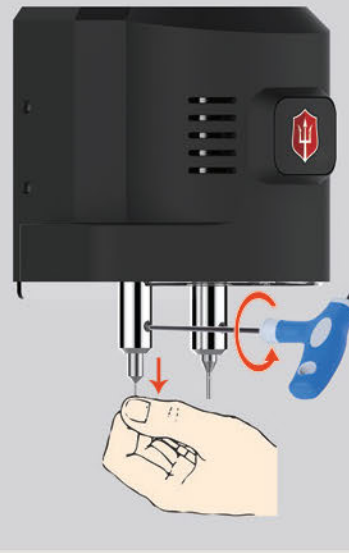

Steps for Decoder Disassembly:

1. Hold the decoder and loosen M5 screw by turning 2.5mm T-wrench counterclockwise.
2. Remove the decoder.

Key Clamping

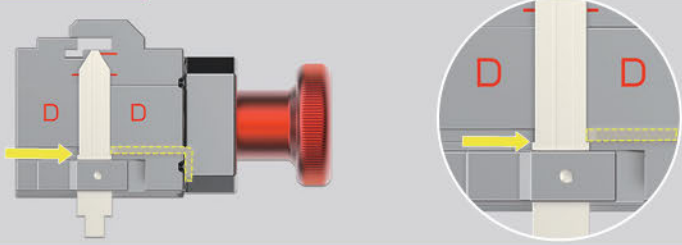
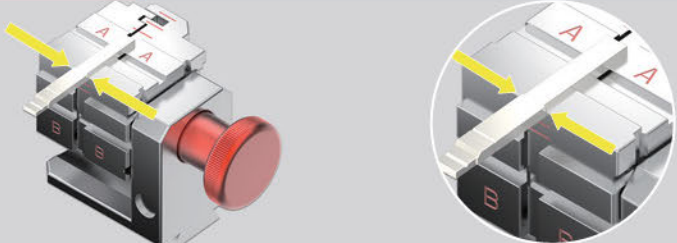
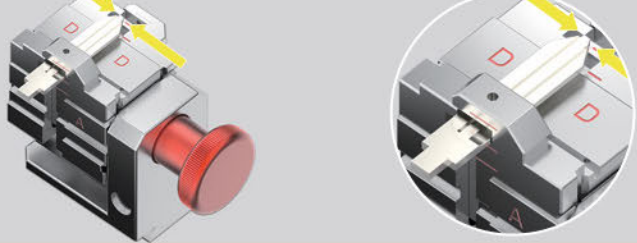
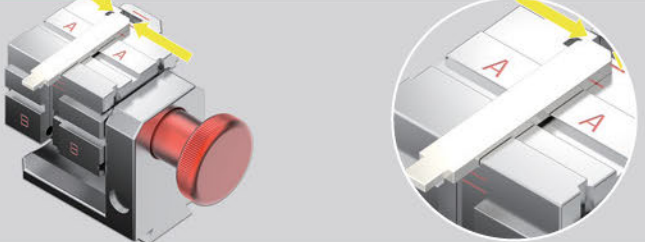
Standard Key	Install standard key at the top of the jaw	Shoulder Align
		
Laser Key	Install laser key at the bottom of the jaw	Tip Align
		
Standard Key	Install standard key at the top of the jaw	Tip Align
		
Laser Key	Install laser key at the bottom of the jaw	Tip Align
		

Key Clamping

(continued...)

Please avoid the mistakes below when clamping keys:



S1 Jaw - Standard Key

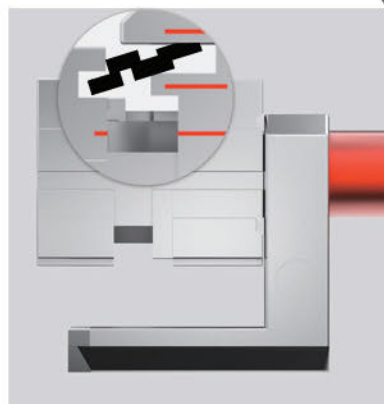
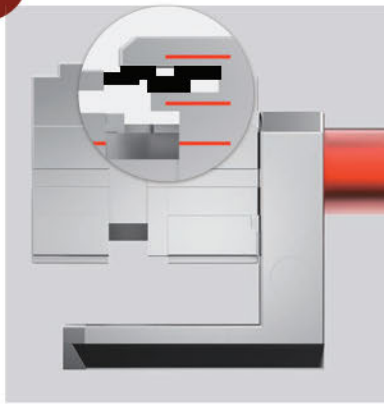

S1 Jaw - Laser Key

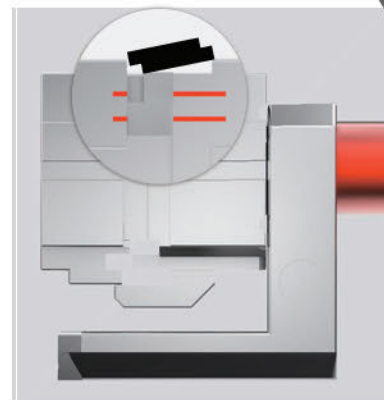
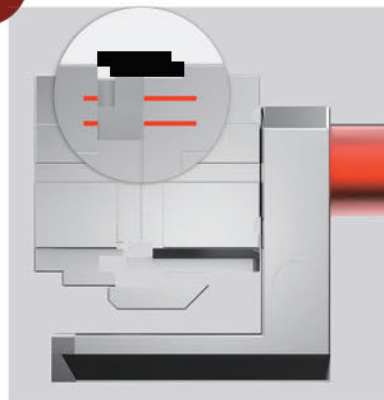

Key Clamping

Please avoid the mistakes below when clamping keys:



S2 Jaw - Single Standard Key

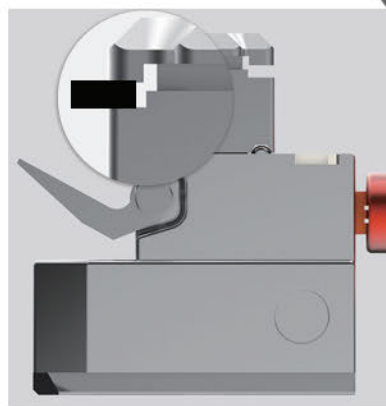
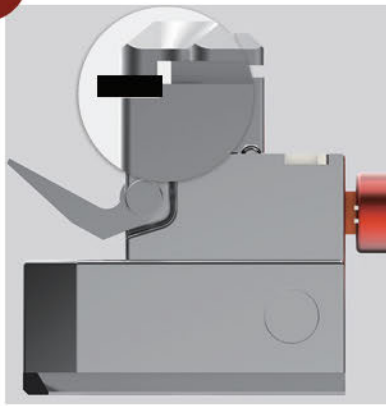

S3 Jaw - Tubular Key

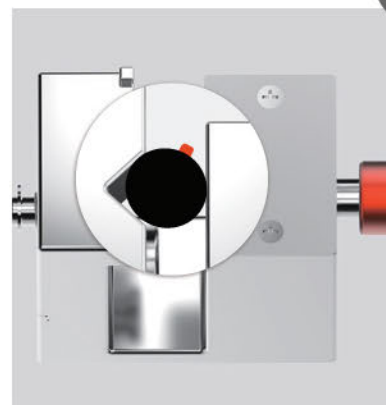
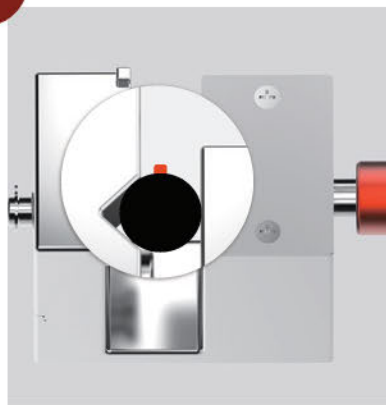

Key Clamping

(continued...)

Please avoid the mistakes below when clamping keys:



S4 Jaw - Available for Ford/Jaguar F021 Tibbe keys

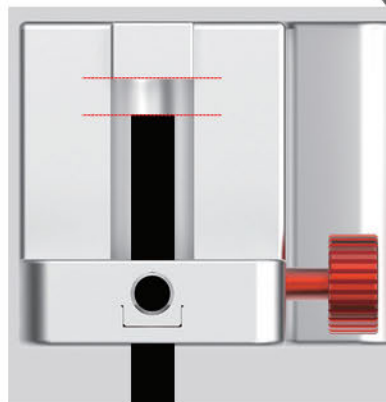
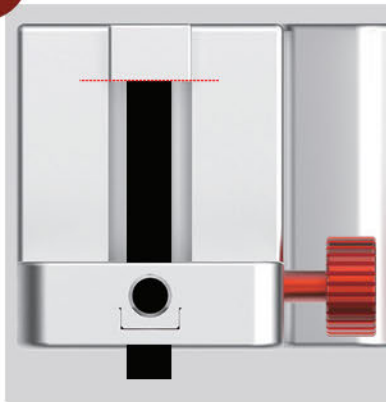

Jaw Instructions

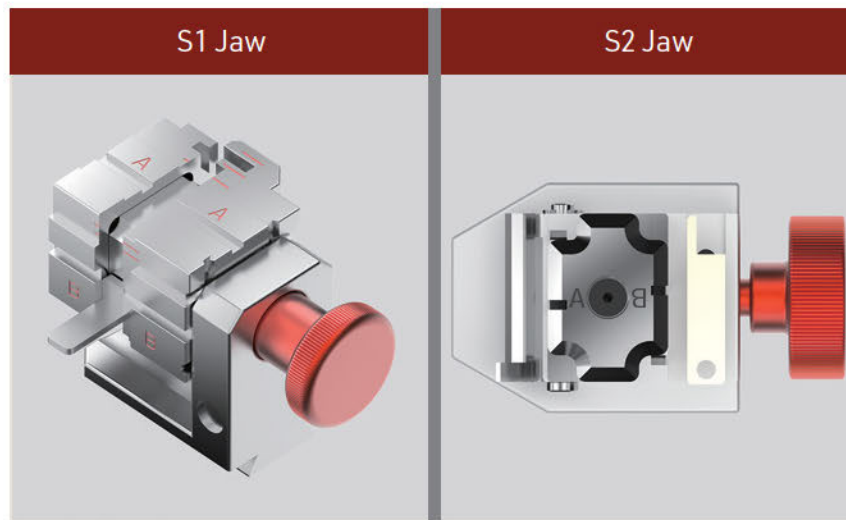

Available for
 Double standard keys, Single internal groove keys, Single external groove keys, Double internal groove keys, Double external groove keys, Dimple keys.

Available for
 Single standard keys.

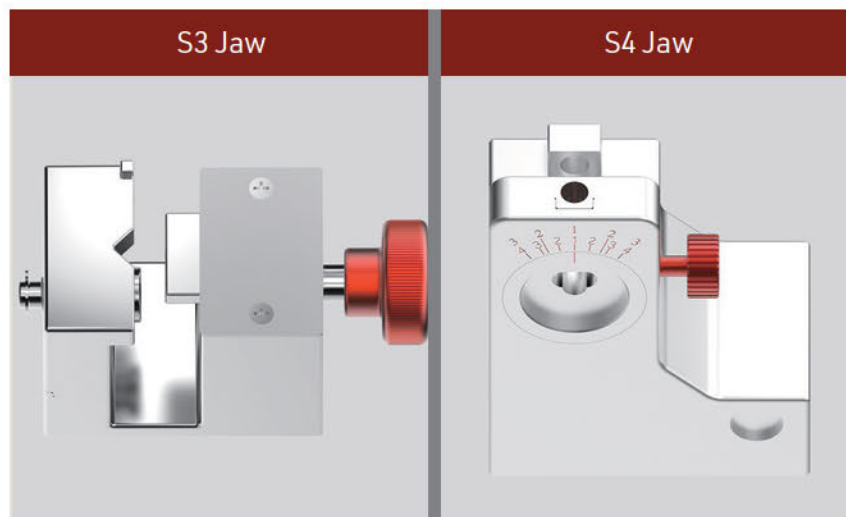







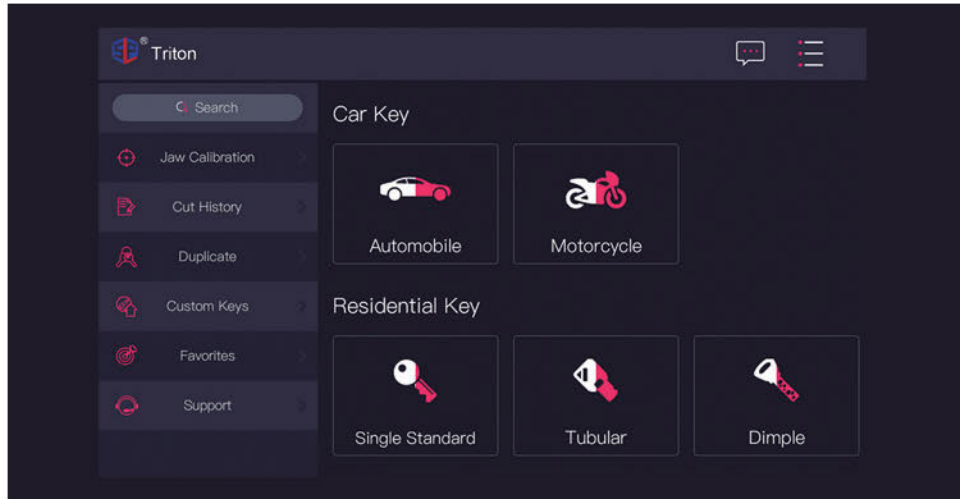

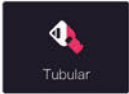

Available for
 Tubular keys.

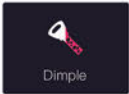
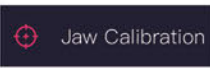
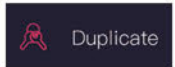
Available for
 Ford F021 Tibbe (6 cuts) and Jaguar F021 Tibbe (8 cuts) keys

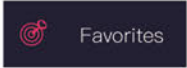
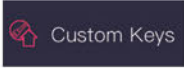
Standard Menu

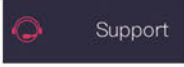



	Automobile		Motorcycle
	Tubular		Single Standard
	Dimple		Jaw Calibration
	Duplicate		Cut History
	Favorites		Custom Keys
	Menu		Support
	Message		Search

Standard Menu

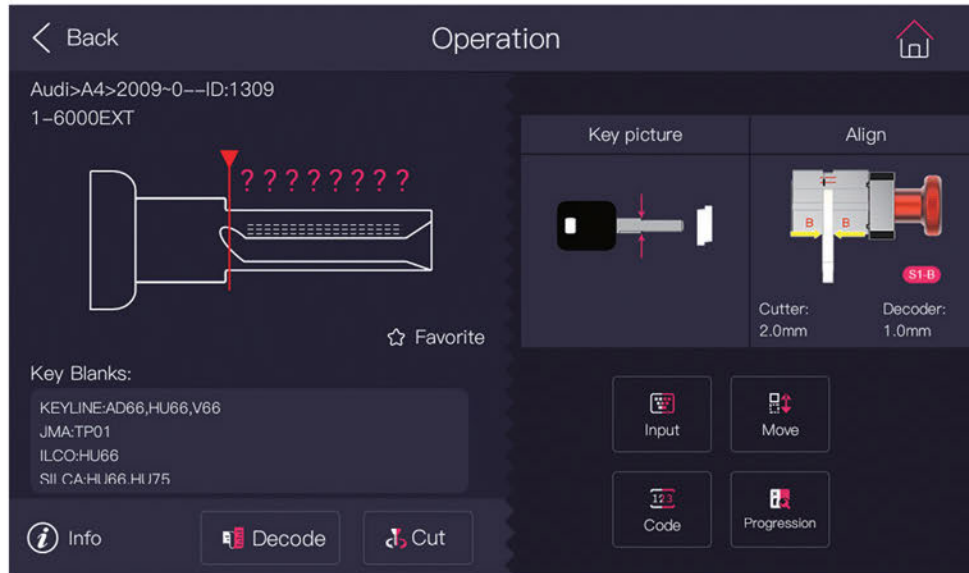
(continued...)

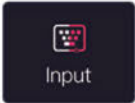
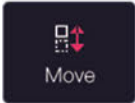
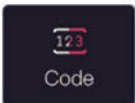
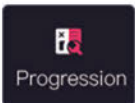
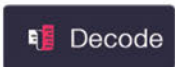

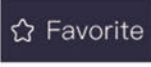



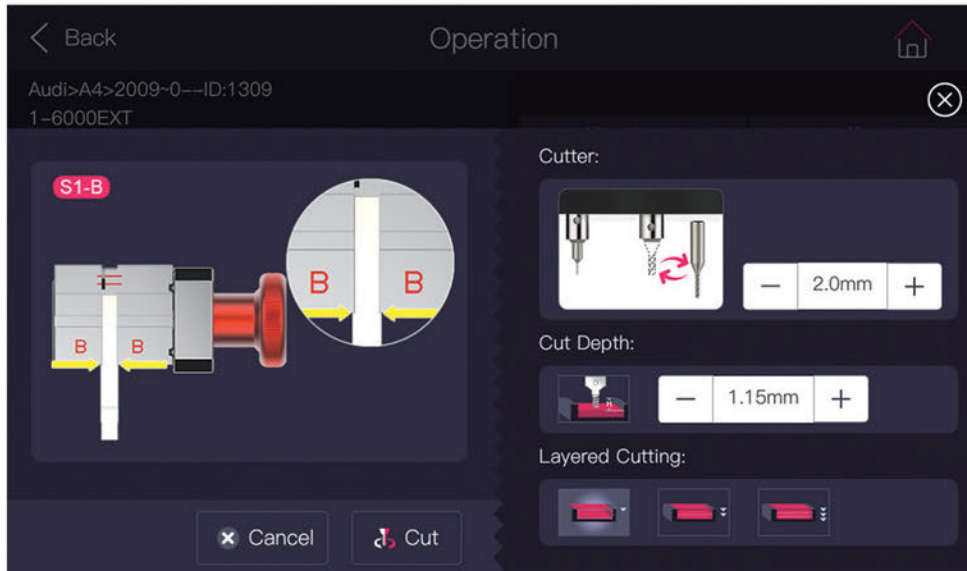

	Input bitting numbers		Jaw Move
	Get bitting numbers by key code		Input existing bitting numbers to get unknown bitting number
	Decode key		Cut key
	Show basic information		Collect common keys

Standard Menu

(continued...)



Cutter			
	Please insert the cutter shown as picture.		
	You can manually set the cutting depth when cutting laser keys.		
Cutting depth			
	When cutting laser keys, you can choose 1,2 or 3 cuts to finish the cutting depth. The harder the key blank is, the more cuts that will be needed		
	When cutting laser keys, you can choose 1,2 or 3 cuts to finish the cutting depth. The harder the key blank is, the more cuts that will be needed.		
Layered Cutting			
	You can manually set the cutting depth when cutting laser keys.		
	Cancel the operation		Start cutting key

Jaw Calibration

1. Automobile Key Jaw (S1-A)

Jaw Calibration

Step 1.

Choose Automobile Key Jaw (S1)

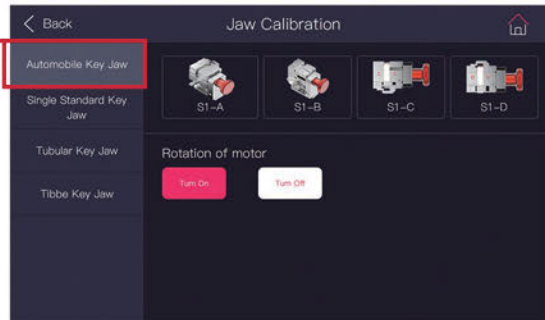

Step 2.

Choose Side A (S1-A)

Step 3.

Change cutter to decoder, place the calibration block and fix Jaw tightly, then click "OK" button as shown in picture.

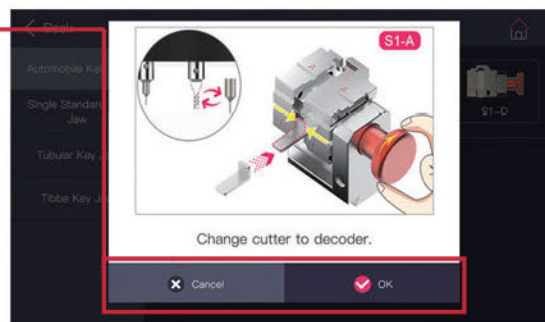

Jaw Calibration

(continued...)

2. Automobile Key Jaw (S1-B) Jaw Calibration

Step 1.

Choose Automobile Key Jaw (S1)

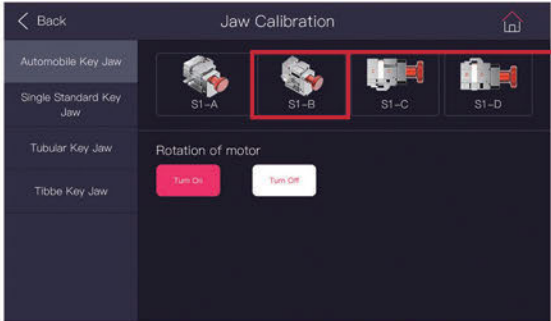
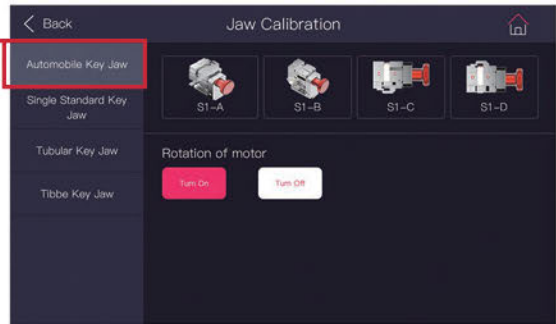

Step 2.

Choose Side B (S1-B)

Step 3.

Change cutter to decoder, place the calibration block and fix Jaw tightly, then click "OK" button as shown in picture.

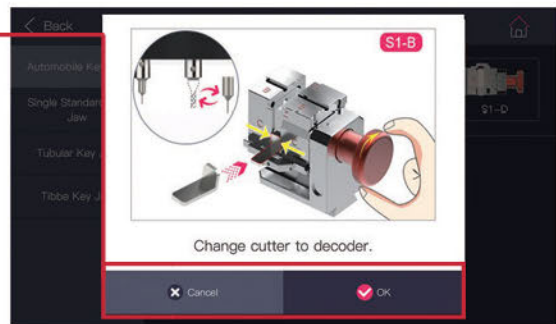

Jaw Calibration

3. Automobile Key Jaw (S1-C)

Jaw Calibration

Step 1.

Choose Automobile Key Jaw (S1)

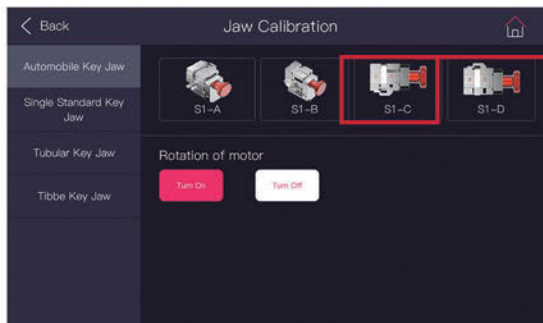
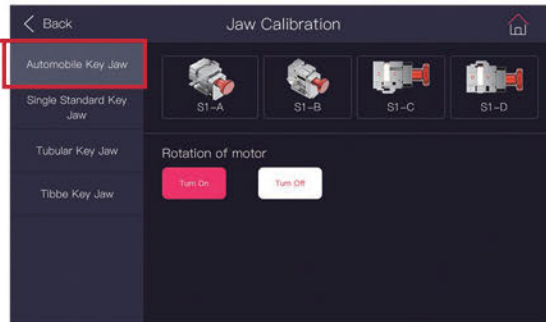

Step 2.

Choose Side C (S1-C)

Step 3.

Change cutter to decoder, place the calibration block and fix Jaw tightly, then click "OK" button as shown in picture.

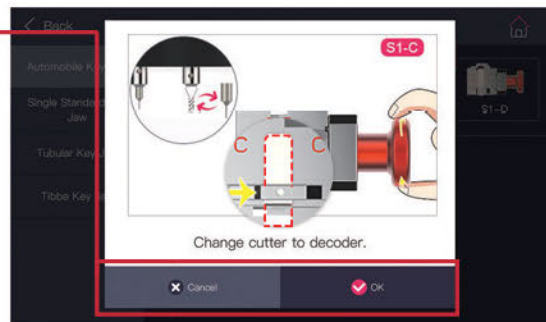

Jaw Calibration

(continued...)

4. Automobile Key Jaw (S1-D) Jaw Calibration

Step 1.

Choose Automobile Key Jaw (S1)

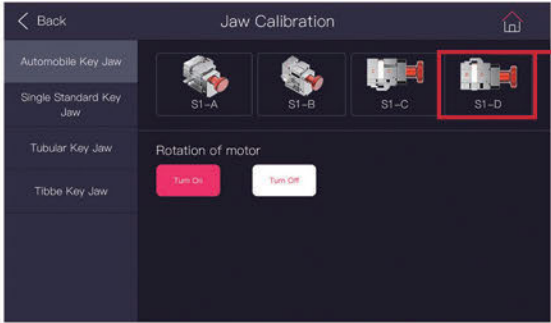
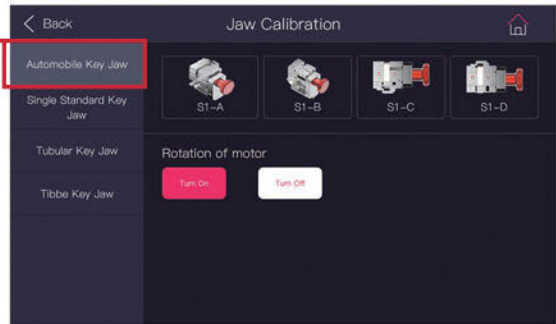

Step 2.

Choose Side D (S1-D)

Step 3.

Change cutter to decoder, place the calibration block and fix Jaw tightly, then click "OK" button as shown in picture.

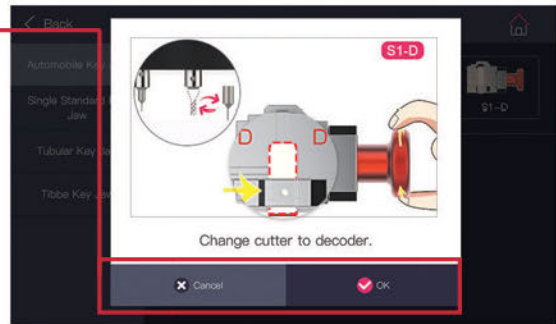

Jaw Calibration

5. Single Standard Key Jaw (S2-A)

Jaw Calibration

Step 1.

Choose Single Standard Key Jaw (S2)

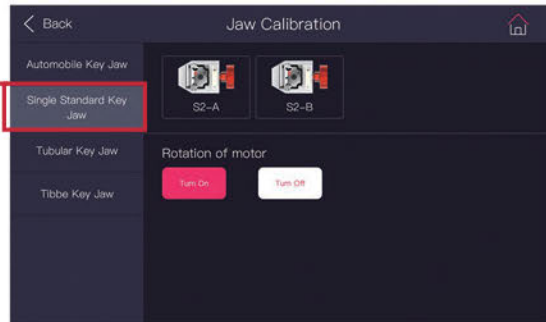

Step 2.

Choose Side A (S2-A)

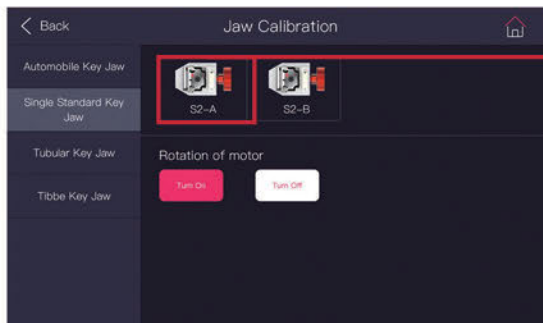

Step 3.

Change cutter to decoder, place the calibration block and fix Jaw tightly, then click "OK" button as shown in picture.

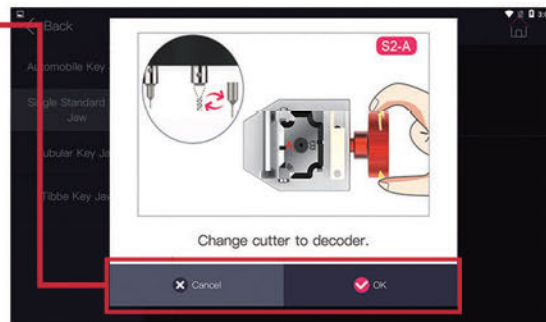

Jaw Calibration

(continued...)

6. Single Standard Key Jaw (S2-B)

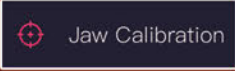

Step 1.

Choose Single Standard Key Jaw (S2)

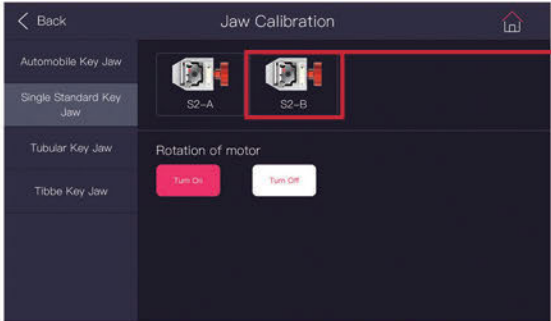
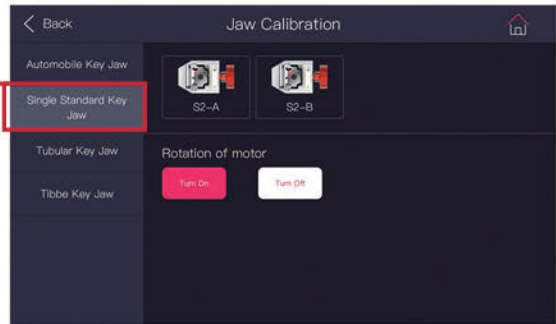

Step 2.

Choose Side B (S2-B)

Step 3.

Change cutter to decoder, place the calibration block and fix Jaw tightly, then click "OK" button as shown in picture.

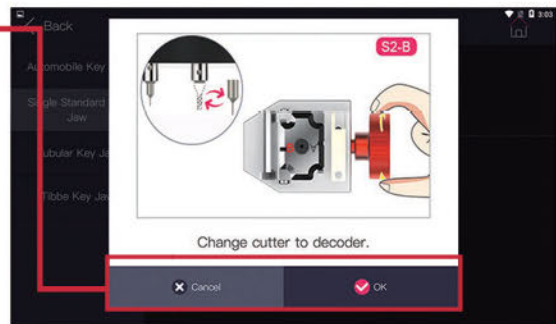

Jaw Calibration

7. Tubular Key Jaw (S3)

Jaw Calibration

Step 1.

Choose Tubular Key Jaw (S3)

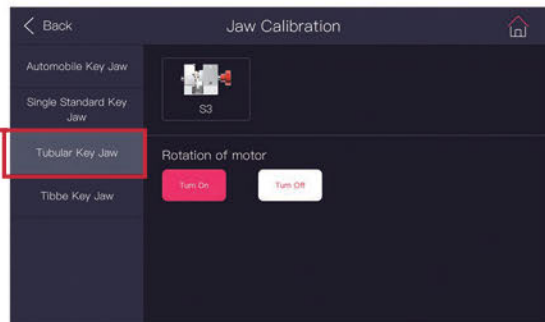

Step 2.

Choose Jaw (S3)

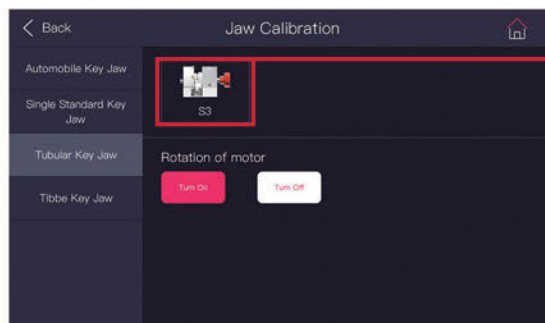

Step 3.

Change cutter to decoder, place the calibration block and fix Jaw tightly, then click "OK" button as shown in picture.

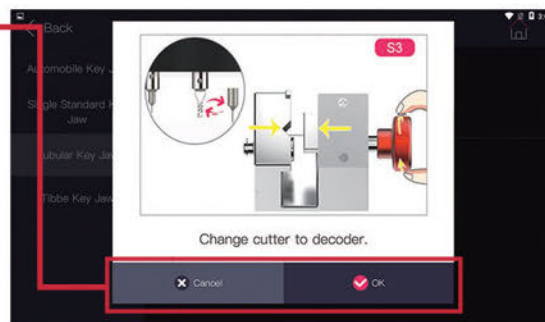

Jaw Calibration

(continued...)

8. Ford/Jaguar Tibbe Key Jaw (S4)

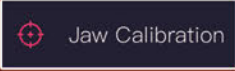

Step 1.

Choose Tibbe Key Jaw (S4)

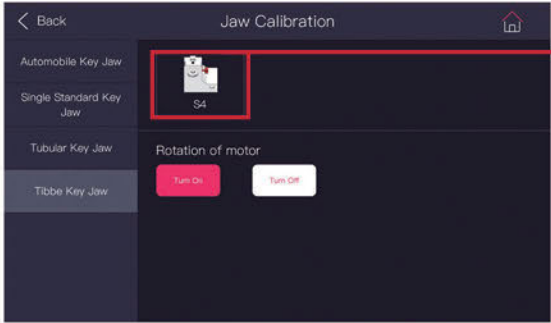
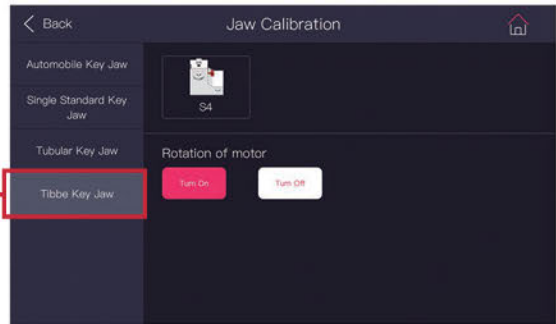

Step 2.

Choose Jaw (S4)

Step 3.

Change cutter to decoder, place the calibration block and fix Jaw tightly, then click "OK" button as shown in picture.

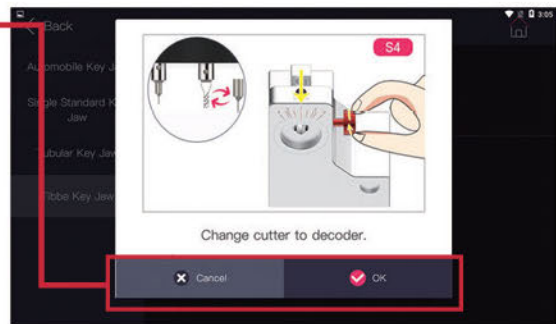

Search

Key Blank Search

Example: HU66 (Volkswagen, Audi, Skoda)

You can search key data by key blank

(You must be familiar with car key blank in order to use this function.)

Step 1.

Click  Search button

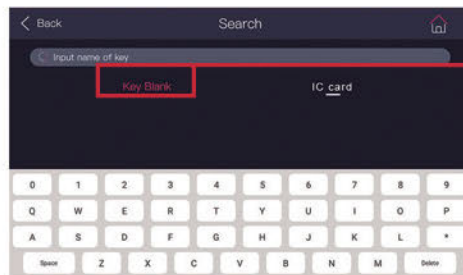
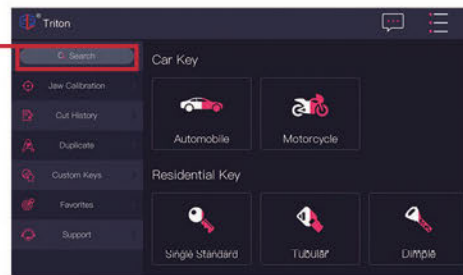

Step 2.

Click "Key Blank" button, then input the key blank number

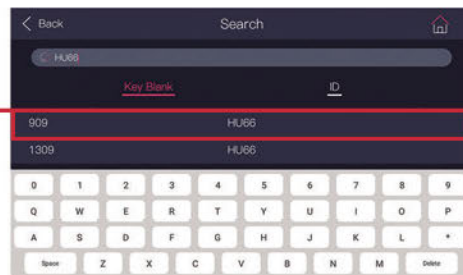

Step 3.

Choose the corresponding key blank manufacturer

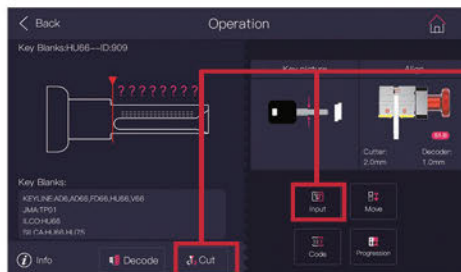

Step 4.

Input the biting numbers and click "OK" button then "Cut" button

Search

ID Search

Example:909 (Volkswagen, Audi, Skoda)
You can search key data by ID

(You must be familiar with ID from Instacode in order to use this function.)

Step 1.

Click  Search button

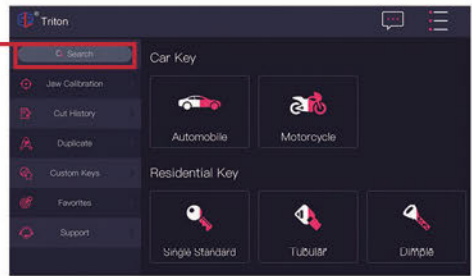

Step 2.

Click "ID" button, then input the ID number

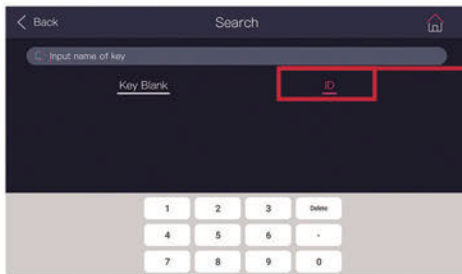

Step 3.

Choose the corresponding ID number

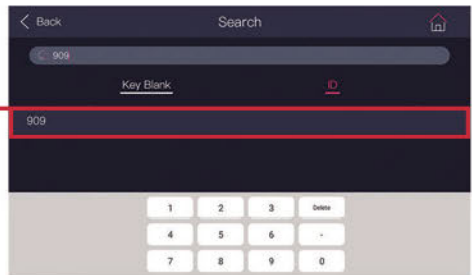

Step 4.

Input the biting numbers and click "OK" button then "Cut" button

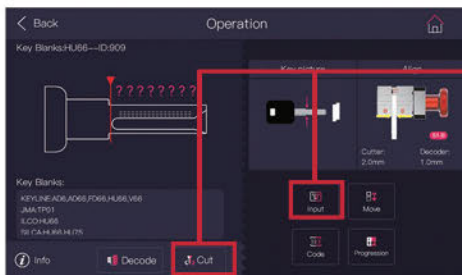

Settings Menu

Language

Step 1.

Click  button

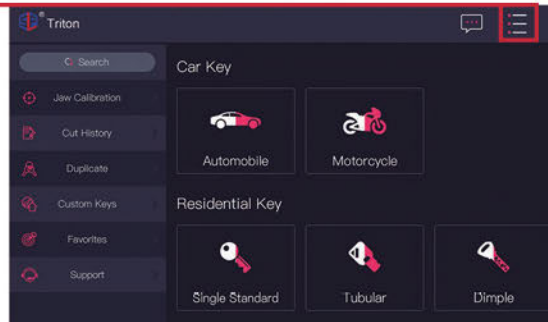

Step 2.

Click "Language" button

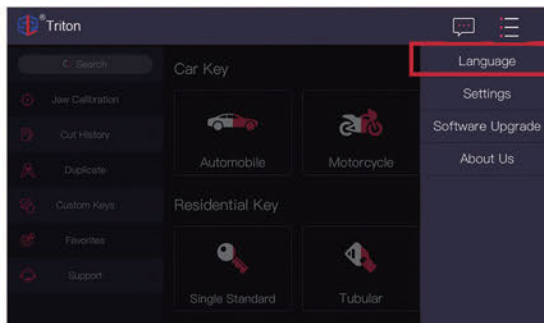

Step 3.

Choose the language you need

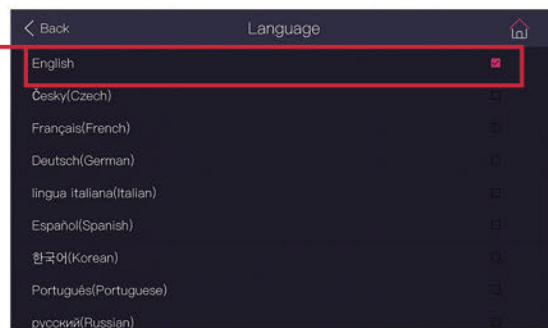

Settings Menu

Software Upgrade

Step 1.

Click  button

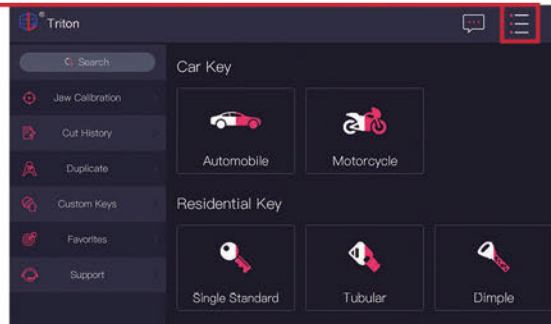

Step 2.

Click "Software Upgrade" button

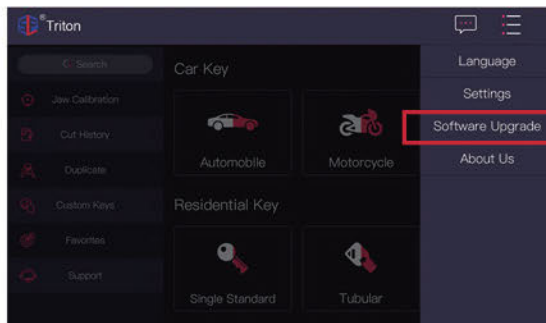

Step 3.

Click "Upgrade" button to upgrade your equipment

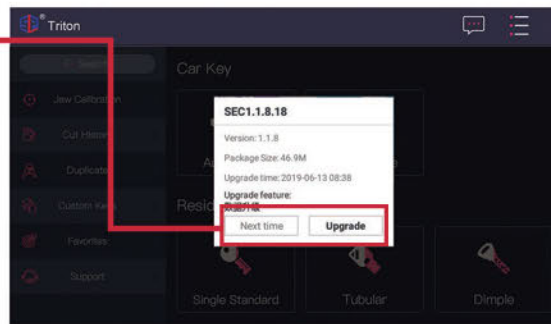

Settings Menu

Cutting Speed

Step 1.

Click  button

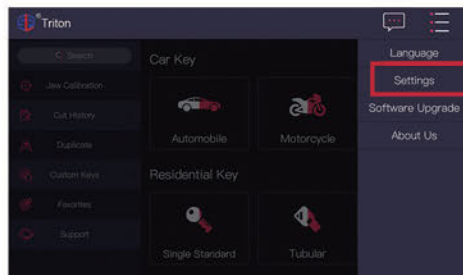
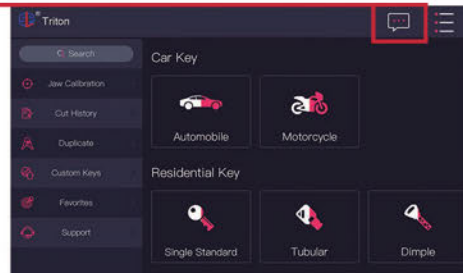

Step 2.

Click "Settings" button

Step 3.

Click "Cutting Speed" button

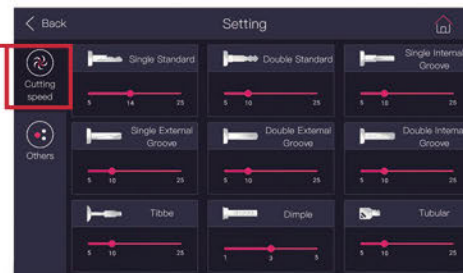

Step 4.

Slide progress bar to adjust cutting speed



Settings Menu

Shield Override

Step 1.

Click  button

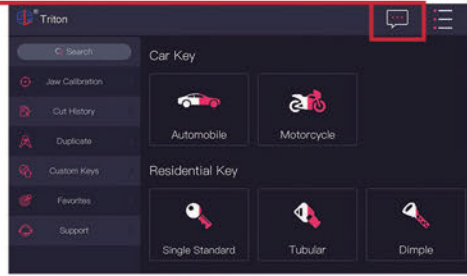

Step 2.

Click "Settings" button

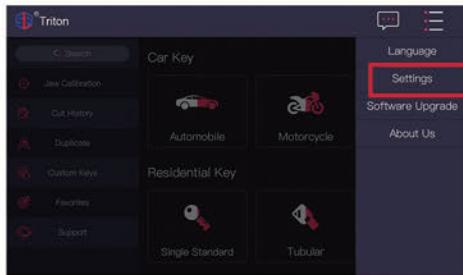

Step 3.

Click "Others" button

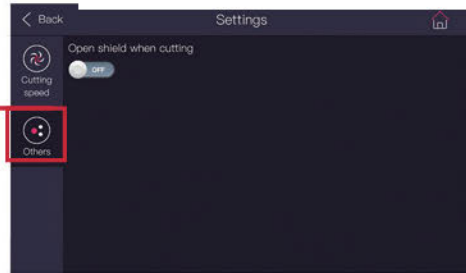

Step 4.

Slide to "On" to allow shield to be open during cutting

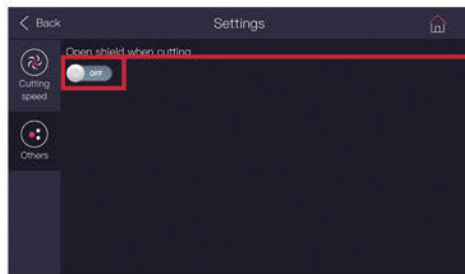

Settings Menu

About Us

Step 1.

Click  button

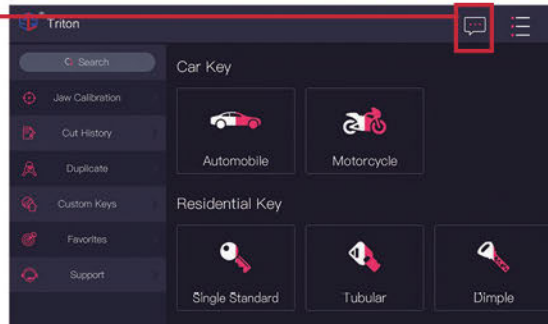

Step 2.

Click "About Us" button

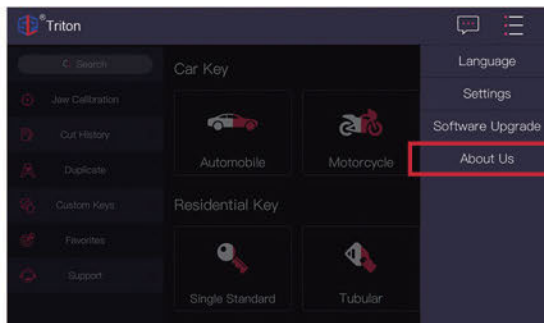

Step 3.

View details of "About Us"



Key Decoding

Key Decoding

Step 1.

Click  Decode button

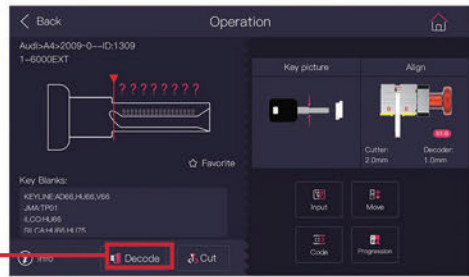

Step 2.

- 1. Confirm key's position
- 2. Place the decoder as shown in picture
- 3. Click "Decode" button

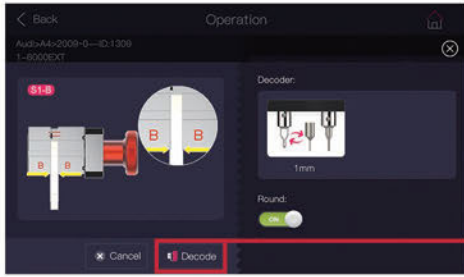

Step 3.

Decoding...wait a moment

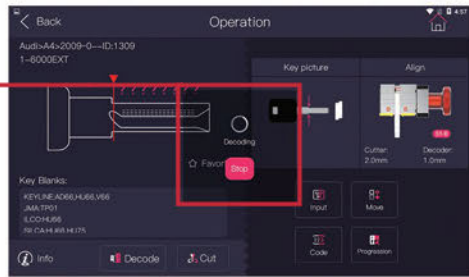

Step 4.

Decoding is done

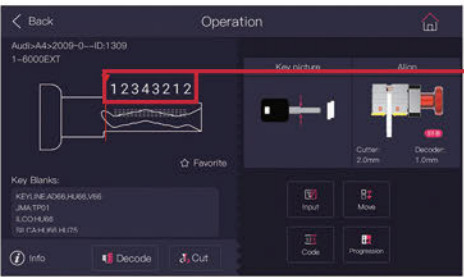

Key Cutting

Example: Audi Q7

(Input known biting numbers to cut a key when the original key is lost)

Step 1.

Click  button
on Home Page

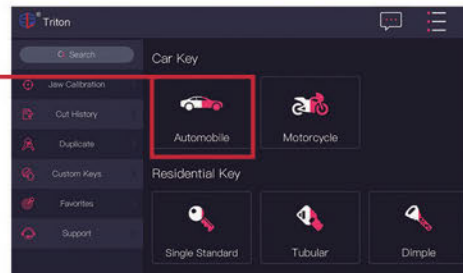

Step 2.

Choose "Audi"
in the list

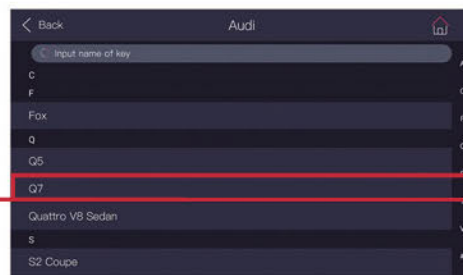

Step 3.

Choose "Q7" in the list

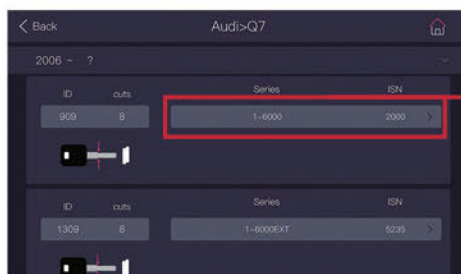

Step 4.

Choose the year of
manufacture

Key Cutting

Example: Audi Q7 (cont.) (Input known biting numbers to cut a key when the original key is lost)

Step 5.

Click  button

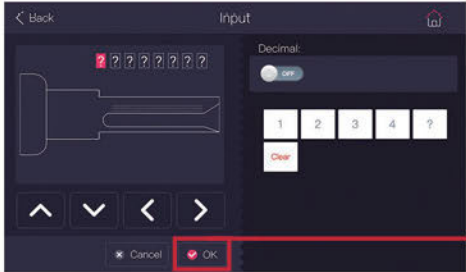
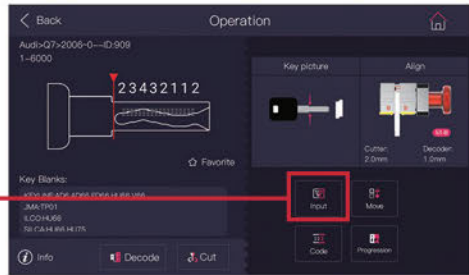

Step 62.

Input known biting numbers then click "OK" button

Step 7.

Check if the biting numbers are correct or not, then click  button



Step 8.

- 1. Fix the key as shown in picture
- 2. Insert cutter
- 3. Click "Cut" to cut key after confirmed

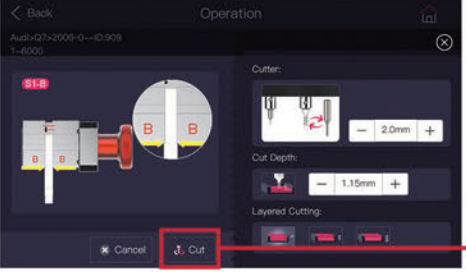

Cutting Depth Adjustment

Example: Honda Accord

Step 1.

Click  button
on Home Page

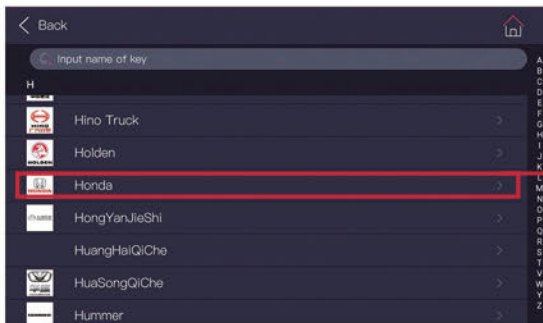
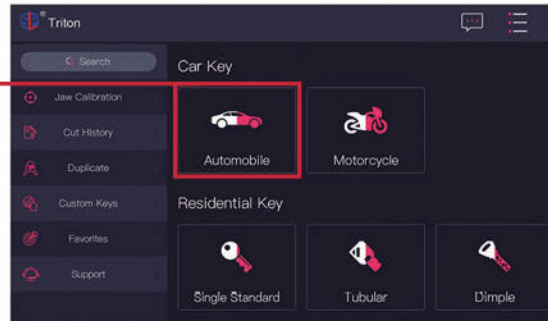

Step 2.

Choose "Honda"
in the list

Step 3.

Choose "Accord"
in the list



Cutting Depth Adjustment

Example: Honda Accord (cont.)

Step 4.

Choose the year of manufacture

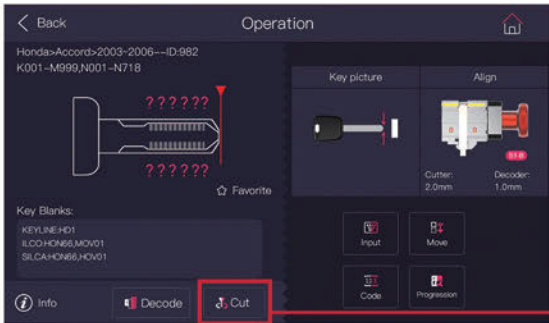

Step 5.

Click  button to pop out invisible window

Step 6.

Change the cutting depth by using "+, -" buttons

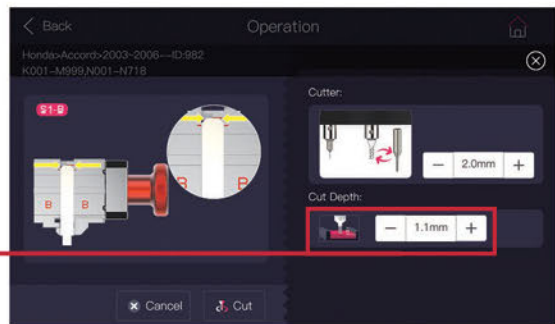

Layered Cutting

Example: Audi Q7

(Input known biting numbers to cut a key when the original key is lost)

Step 1.

Click  button
on Home Page

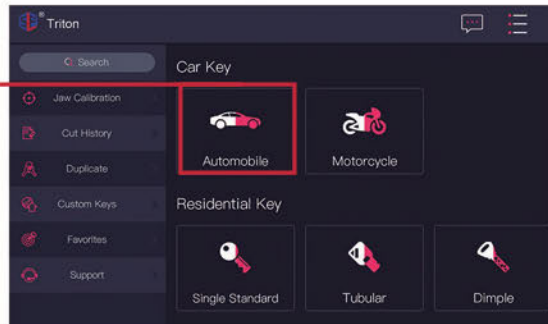

Step 2.

Choose "Audi"
in the list

Step 3.

Choose "Q7" in the list

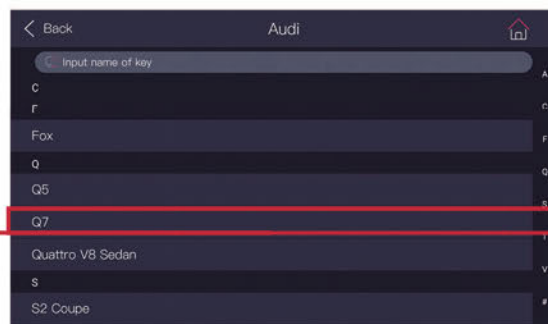

Layered Cutting

Example: Audi Q7 (cont.)

(Input known biting numbers to cut a key when the original key is lost)

Step 4.

Choose year of manufacture

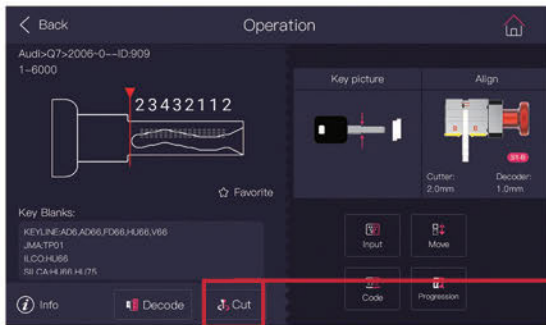
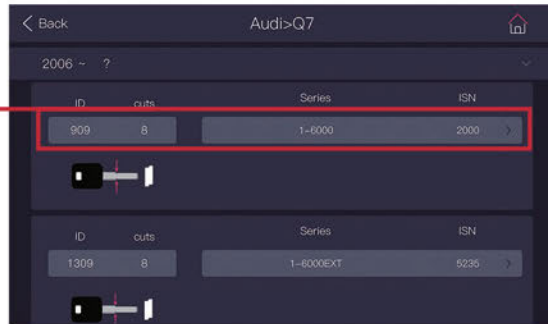

Step 5.

Click  button

Step 6.

Choose corresponding "Layered Cutting" icon

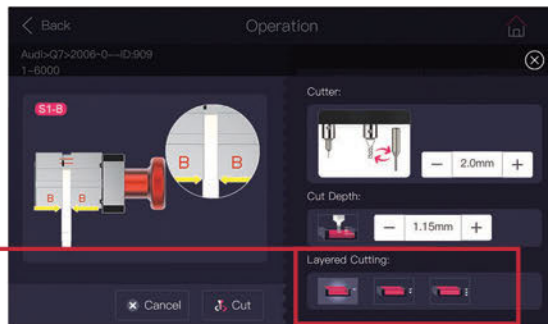

Move

Example: Audi Q7

(Input known biting numbers to cut a key when the original key is lost)

Step 1.

Click  button
on Home Page

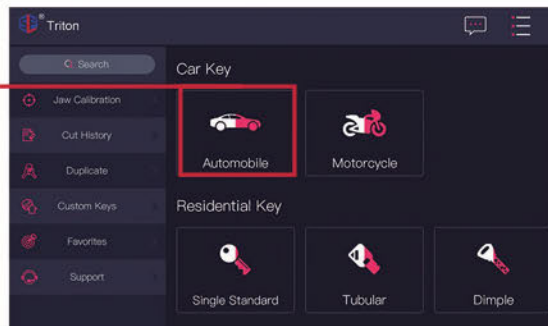

Step 2.

Choose "Audi"
in the list

Step 3.

Choose "Q7" in the list

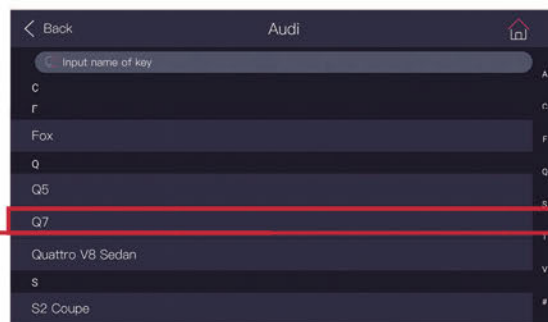

Move

Example: Audi Q7 (cont.) (Input known biting numbers to cut a key when the original key is lost)

Step 4.

Choose year of manufacture

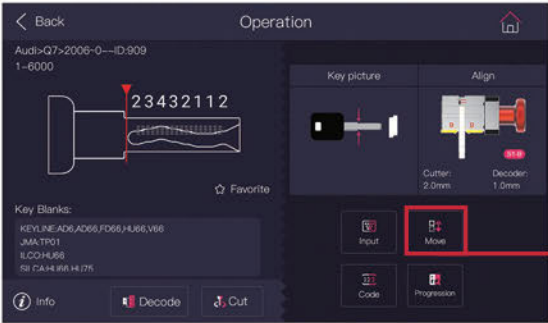

Step 5.

Click  button

Step 6.

Clamp moves

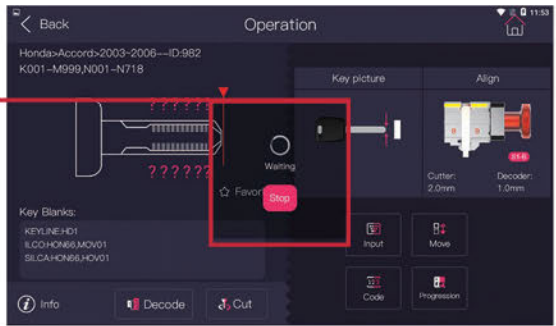

Code

Example: Honda Accord

(How to cut a key when original key is lost)

Step 1.

Click  button
on Home Page

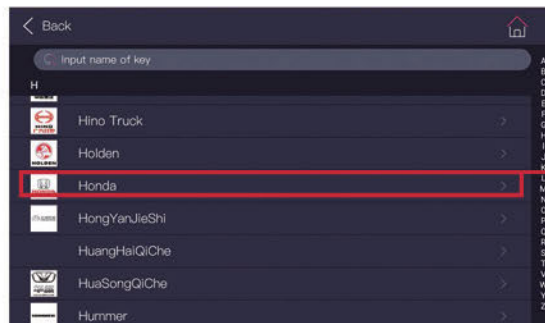
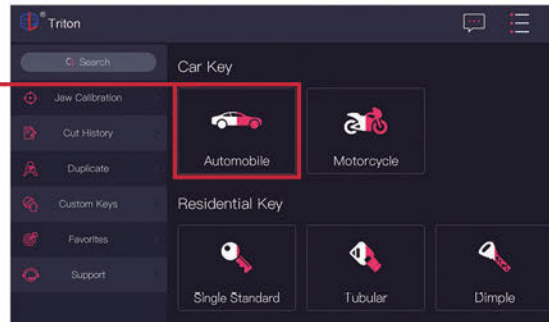

Step 2.

Choose "Honda"
in the list

Step 3.

Choose "Accord" in the list



Code

Example: Honda Accord (cont.) (How to cut a key when original key is lost)

Step 4.

Choose year of manufacture

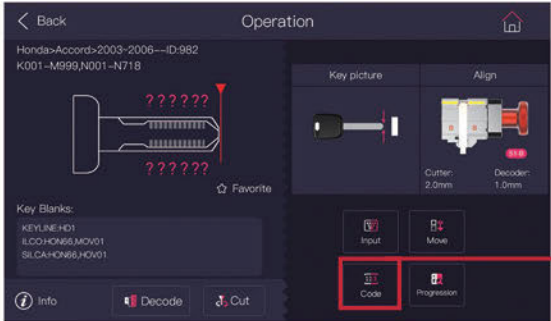

Step 5.

Click  button

Step 6.

Input the code "M081" and click "Search" to get the bitting numbers

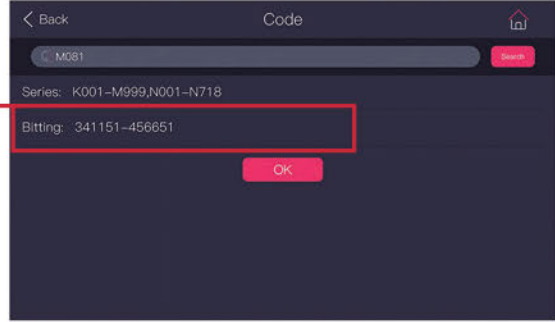

Progression

Example: Audi-Q7

Step 1.

Click  button
on Home Page

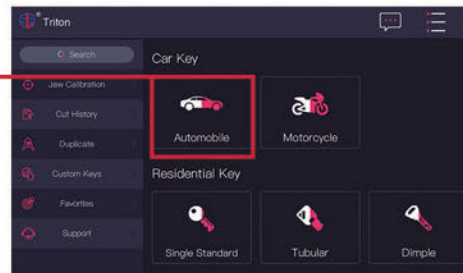

Step 2.

Choose "Audi"
in the list



Step 3.

Choose "Q7" the list

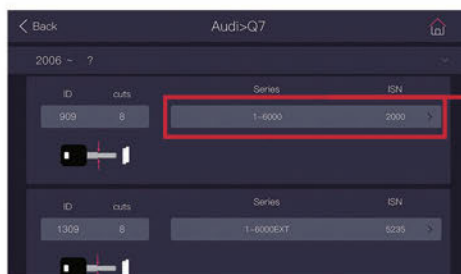

Step 4.

Choose the year of
manufacture

Progression

Example: Audi Q7 (cont.)

Step 5.

Click  button

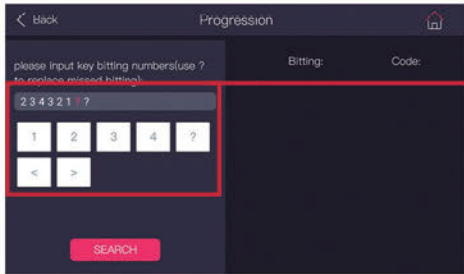
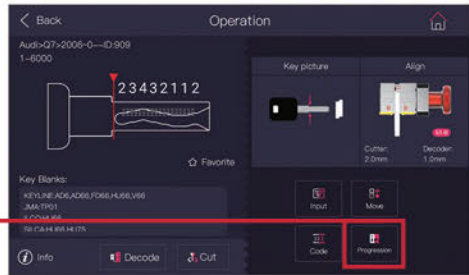

Step 6.

Example: Input known bitting numbers "234321" and keep unknown bitting numbers as "?" in the input box

Step 7.

Make sure the bitting numbers are correct, then click "Search" button

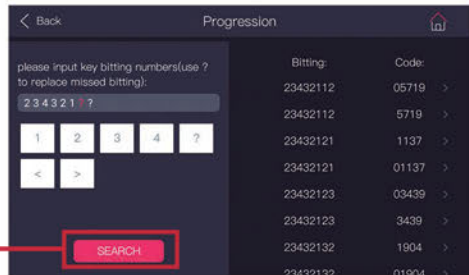

Step 8.

Review search result and choose the corresponding one you need

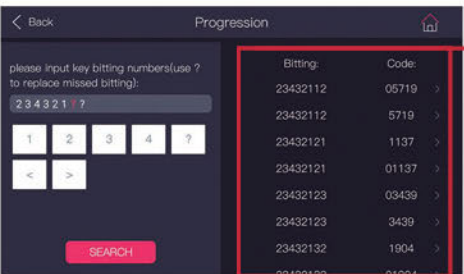

Duplicate

Single Standard Key

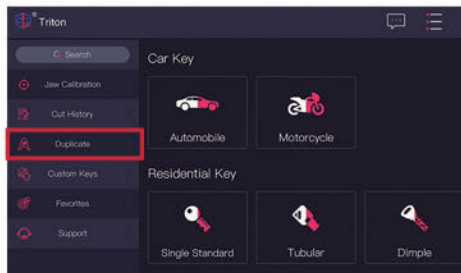

Step 1.

Click "Duplicate" button on Home Page

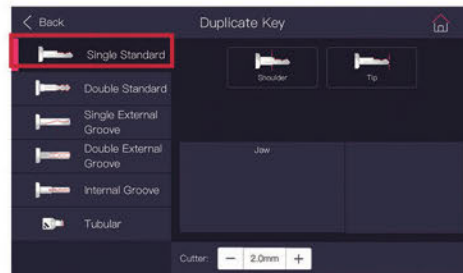

Step 2.

Click "Single Standard" button

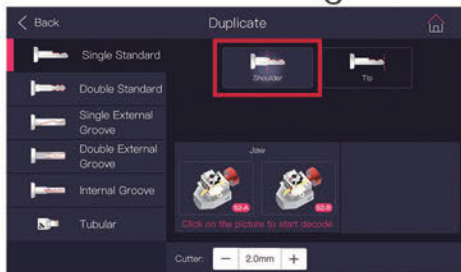

Step 3.

Click "Shoulder" button

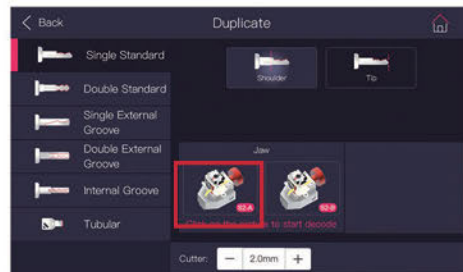

Step 4.

Click "Jaw" button

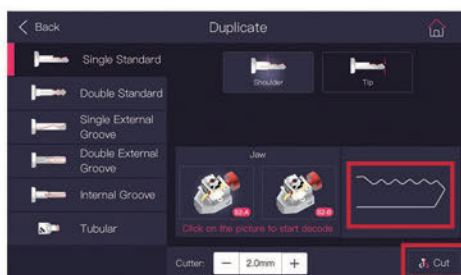

Step 5.

Click "Cut" button after duplicating is done

Duplicate

Double Standard Key

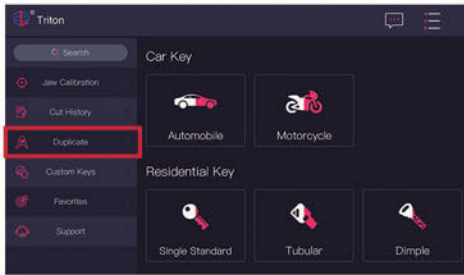

Step 1.

Click "Duplicate" button on Home Page

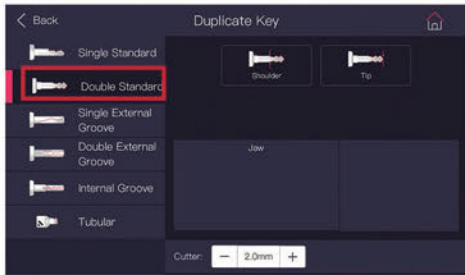

Step 2.

Click "Double Standard" button

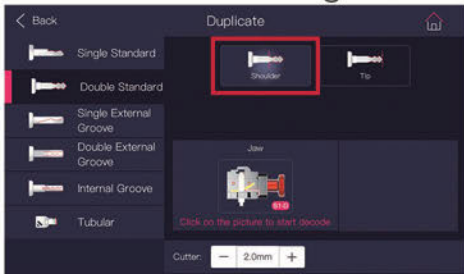

Step 3.

Click "Shoulder" button



Step 4.

Click "Jaw" button

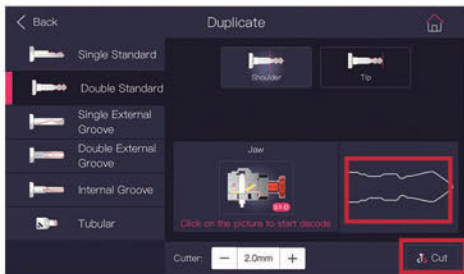

Step 5.

Click "Cut" button after duplicating is done

Duplicate

Single External Groove Key

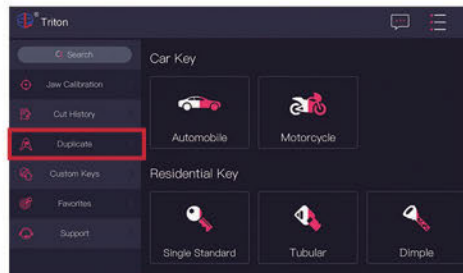

Step 1.

Click "Duplicate" button on Home Page

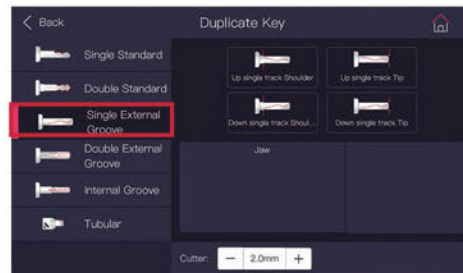

Step 2.

Click "Single External Groove" button



Step 3.

Click "Up Single Track Shoulder" button

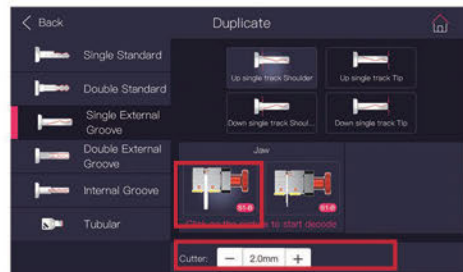

Step 4.

Click "Jaw" button and adjust cutter dimension

Step 5.

Click "Cut" button after duplicating is done

Duplicate

Double External Groove Key

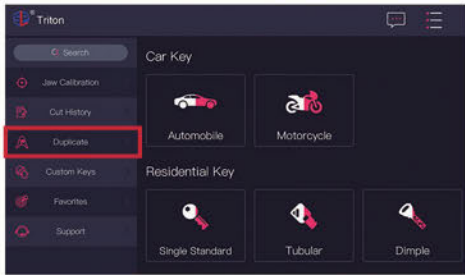

Step 1.

Click "Duplicate" button on Home Page

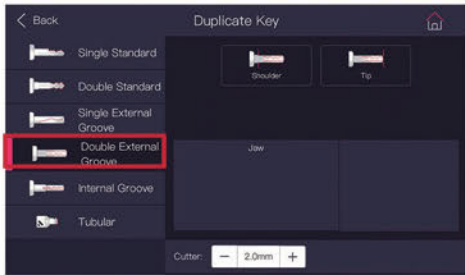

Step 2.

Click "Double External Groove" button

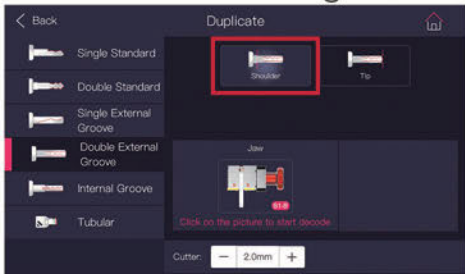

Step 3.

Click "Shoulder" button

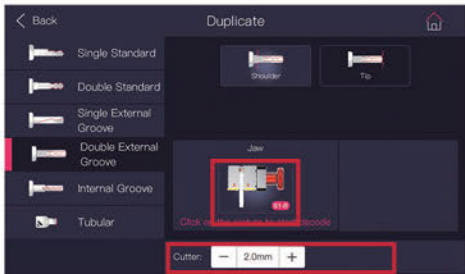

Step 4.

Click "Jaw" button and adjust cutter dimension

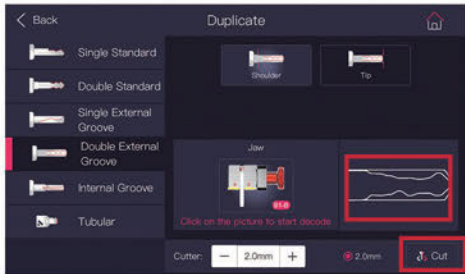

Step 5.

Click "Cut" button after duplicating is done

Duplicate

Internal Groove Key

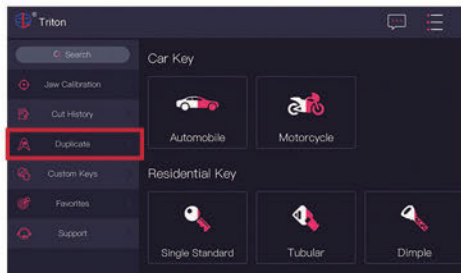

Step 1.

Click "Duplicate" button on Home Page

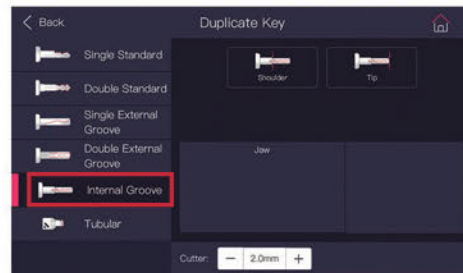

Step 2.

Click "Internal Groove" button

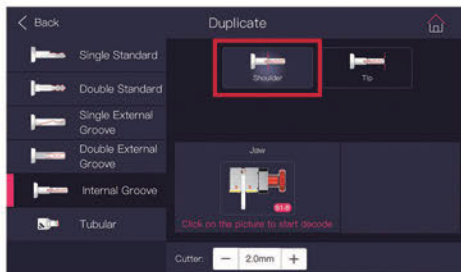

Step 3.

Click "Shoulder" button

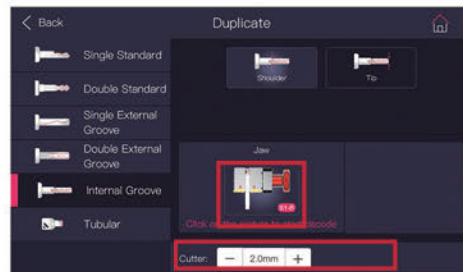

Step 4.

Click "Jaw" button and adjust cutter dimension

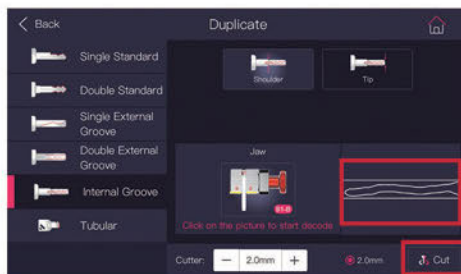

Step 5.

Click "Cut" button after duplicating is done

Duplicate

Tubular Key (continued...)

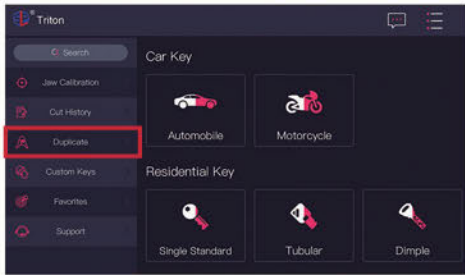

Step 1.

Click "Duplicate" button on Home Page

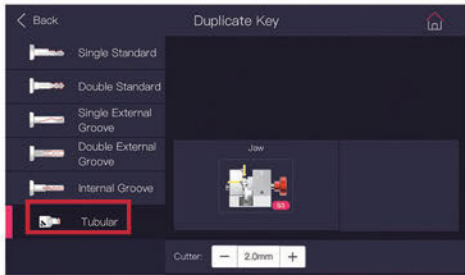

Step 2.

Click "Tubular" button

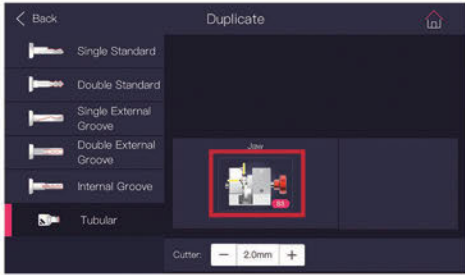

Step 3.

Click "Jaw" button



Step 4.

Click "Cut" button after duplicating is done

Custom Keys

Double Standard Key

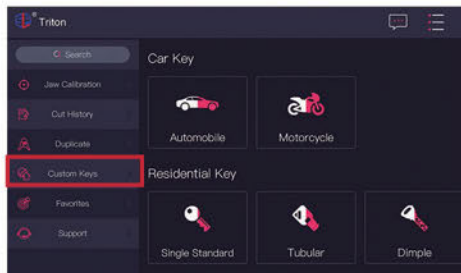

Step 1.

Click "Custom Keys" button on Home Page

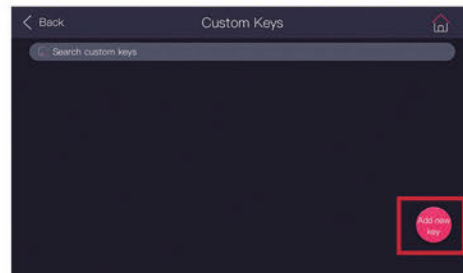

Step 2.

Click "Add New Key" button

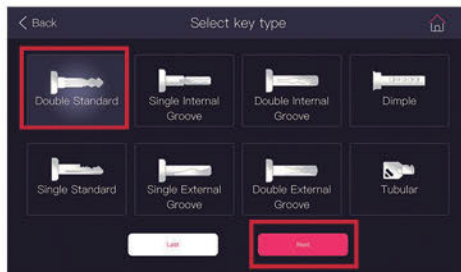

Step 3.

Click "Double Standard" button, then "Next" button



Step 4.

Click "Shoulder" button, then "Next" button

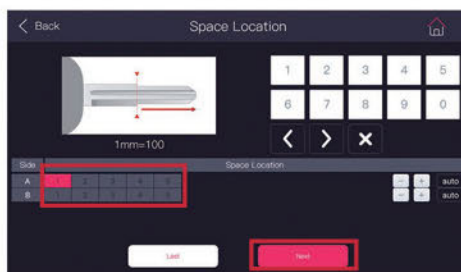

Step 5.

Input the parameters in space location of the key and click "Next" button

Custom Keys

(continued...)



Step 6.

Input the parameters in space width of the key and click "Next" button

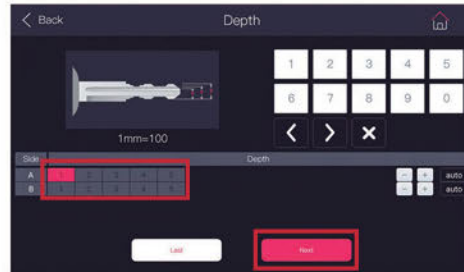

Step 7.

Input the parameters in depth of the key and click "Next" button



Step 8.

Input the parameters in width and click "Next" button

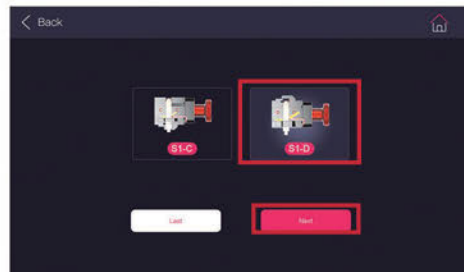

Step 9.

Choose correct "Jaw" and click "Next" button

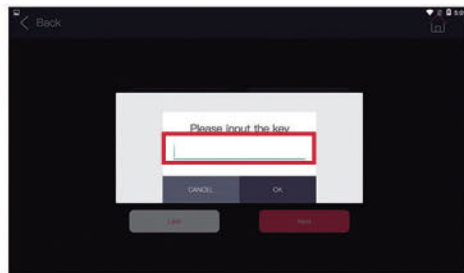

Step 10.

Name the new key data and click "OK" button

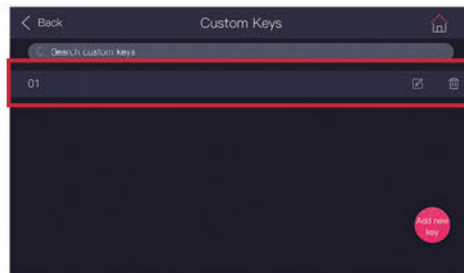

Step 11.

Review the key data you just added

Custom Keys

Single Internal Groove Key

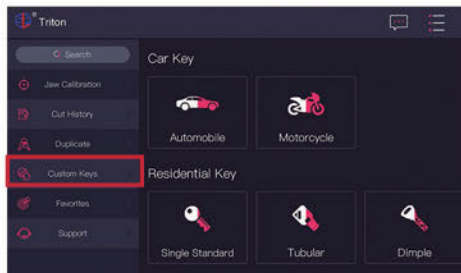

Step 1.

Click "Custom Keys" button on Home Page

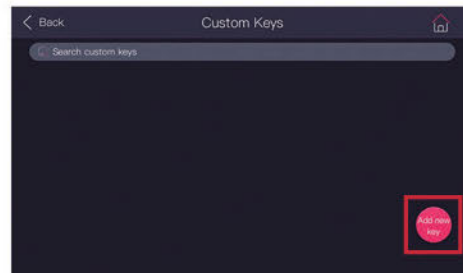

Step 2.

Click "Add New Key" button

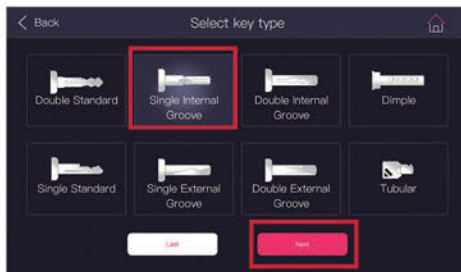

Step 3.

Click "Single Internal Groove Key" button, then "Next" button

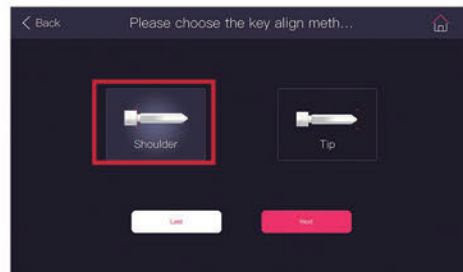

Step 4.

Click "Shoulder" button, then "Next" button

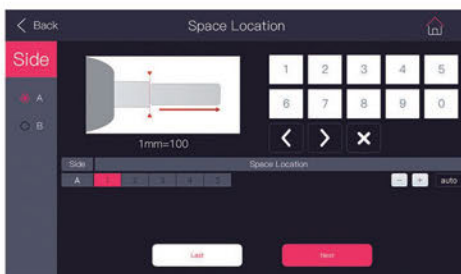

Step 5.

Choose "A" and input the parameters in space location of the key and click "Next" button

Custom Keys

(continued...)

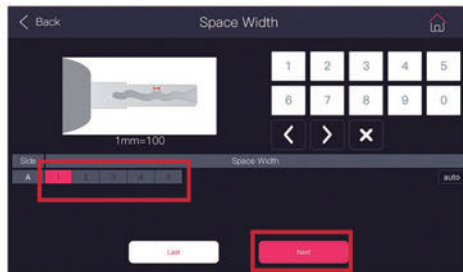

Step 6.

Input the parameters in space width of the key and click "Next" button

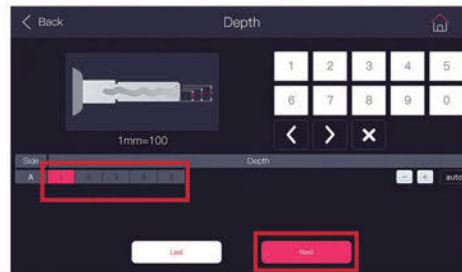

Step 7.

Input the parameters in depth of the key and click "Next" button



Step 8.

Input the parameters in Width, Thickness, Cut Depth, Groove and Guide and click "Next" button

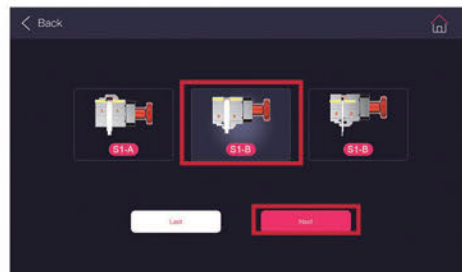

Step 9.

Choose correct "Jaw" and click "Next" button

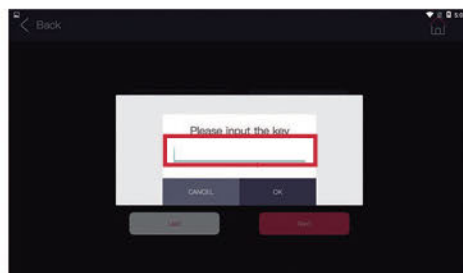

Step 10.

Name the new key data and click "OK" button

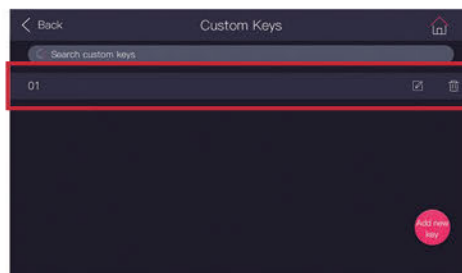

Step 11.

Review the key data you just added

Custom Keys

Double Internal Groove Key

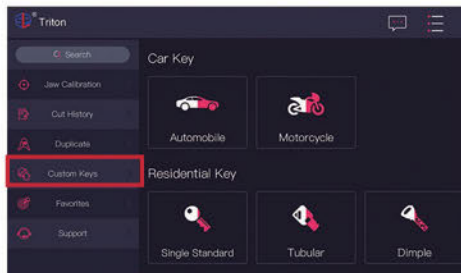

Step 1.

Click "Custom Keys" button on Home Page

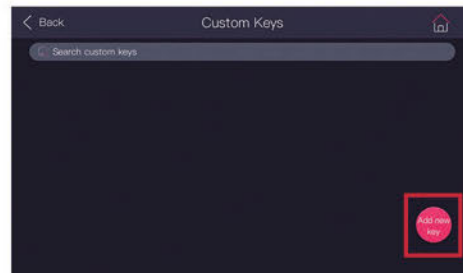

Step 2.

Click "Add New Key" button



Step 3.

Click "Double Internal Groove Key" button, then "Next" button

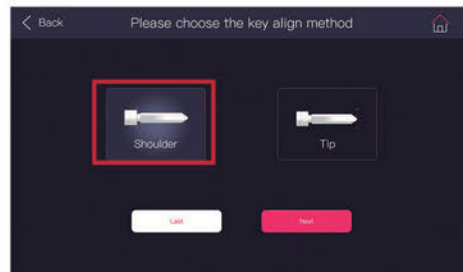

Step 4.

Click "Shoulder" button, then "Next" button

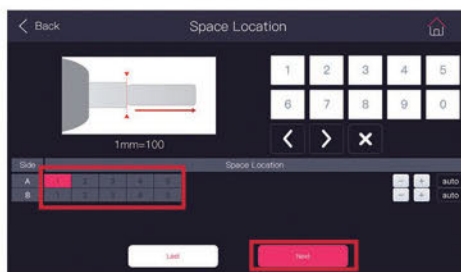

Step 5.

Input the parameters in space location of the key and click "Next" button

Custom Keys

(continued...)

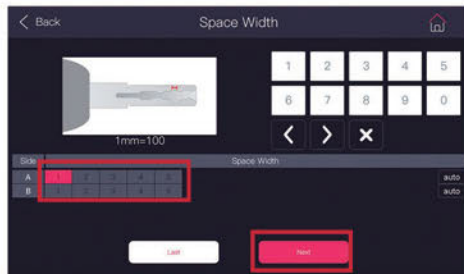

Step 6.

Input the parameters in space width of the key and click "Next" button

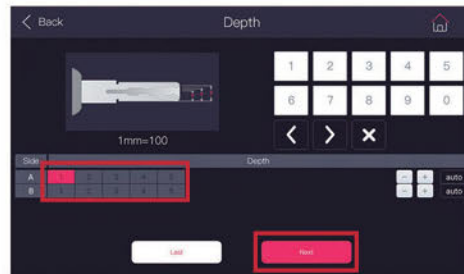

Step 7.

Input the parameters in depth of the key and click "Next" button



Step 8.

Input the parameters in Width, Thickness, Cut Depth, Groove and Nose and click "Next" button

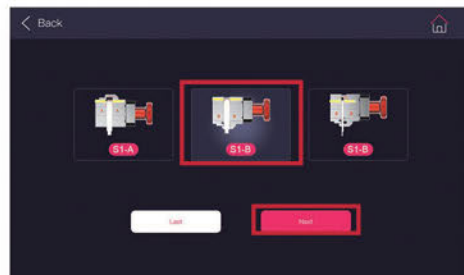

Step 9.

Choose correct "Jaw" and click "Next" button

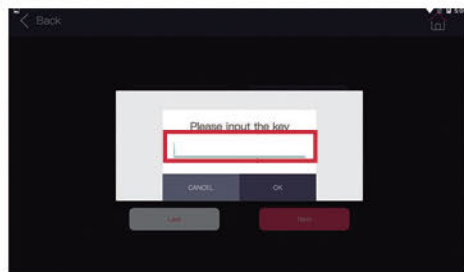

Step 10.

Name the new key data and click "OK" button

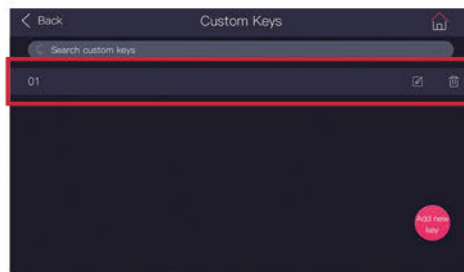

Step 11.

Review the key data you just added

Custom Keys

Dimple Key

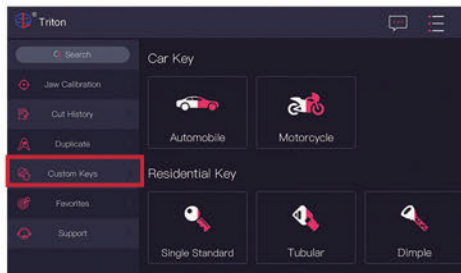

Step 1.

Click "Custom Keys" button on Home Page

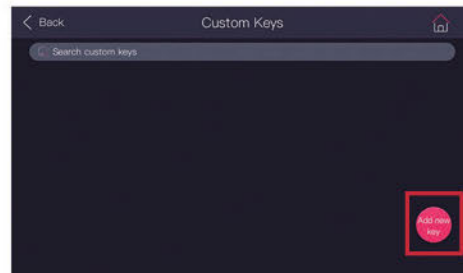

Step 2.

Click "Add New Key" button

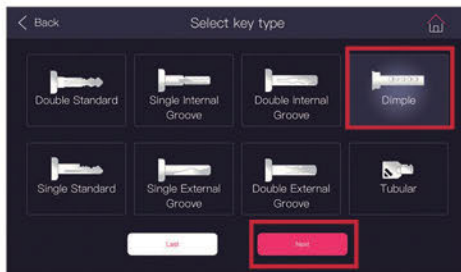

Step 3.

Click "Dimple" button, then "Next" button

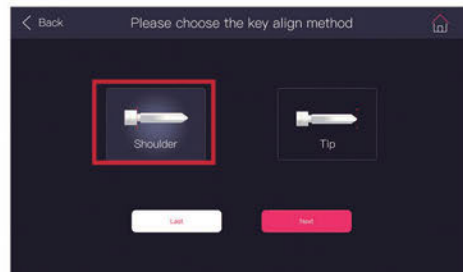

Step 4.

Click "Shoulder" button, then "Next" button

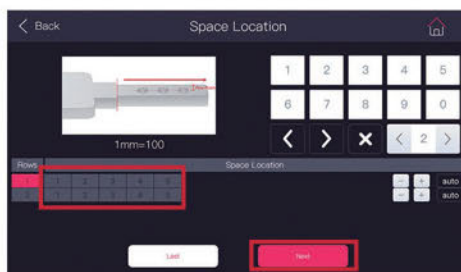

Step 5.

Input the parameters in space location of the key and click "Next" button

Custom Keys

(continued...)

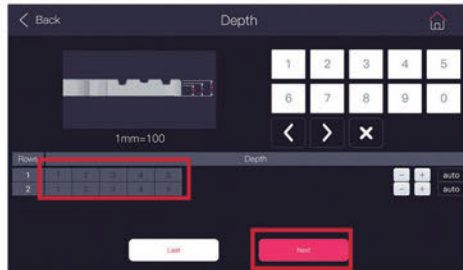

Step 6.

Input the parameters in depth of the key and click "Next" button

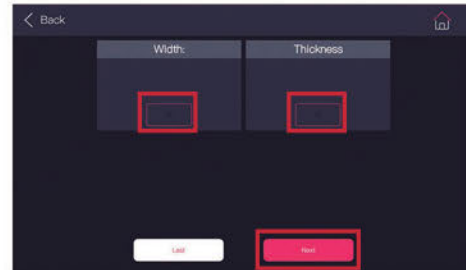

Step 7.

Input the parameters in Width & Thickness and click "Next" button



Step 8.

Choose correct "Jaw" and click "Next" button

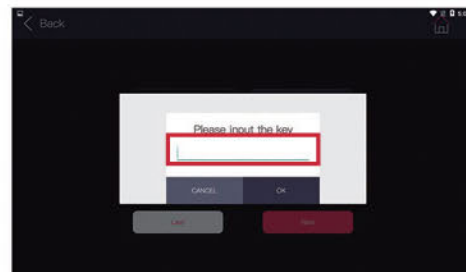

Step 9.

Name the new key data and click "OK" button

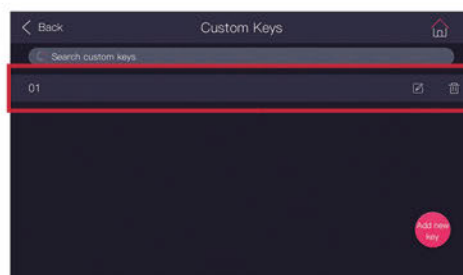

Step 10.

Review the key data you just added

Custom Keys

Single Standard Key

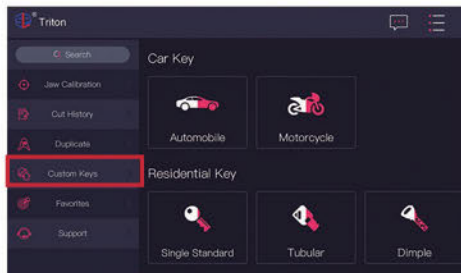

Step 1.

Click "Custom Keys" button on Home Page

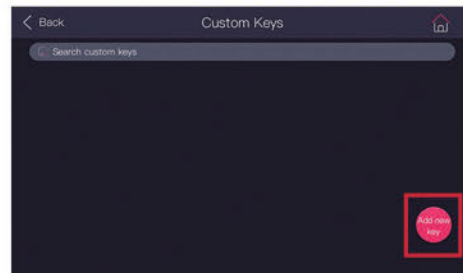

Step 2.

Click "Add New Key" button

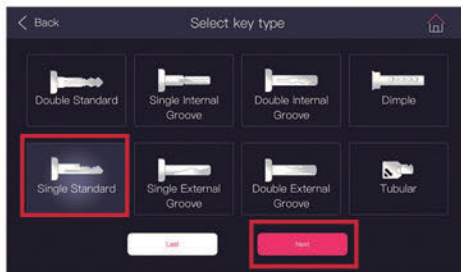

Step 3.

Click "Single Standard" button, then "Next" button

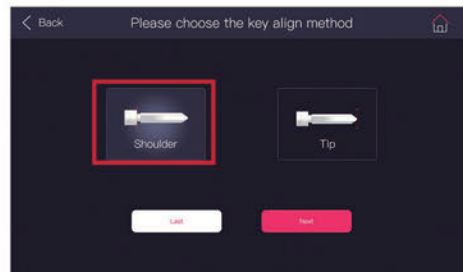

Step 4.

Click "Shoulder" button, then "Next" button

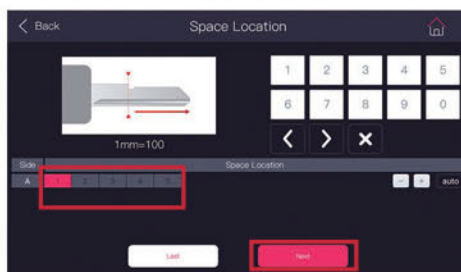

Step 5.

Input the parameters in space location of the key and click "Next" button

Custom Keys

(continued...)

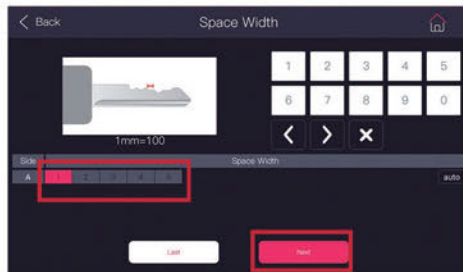

Step 6.

Input the parameters in space width of the key and click "Next" button

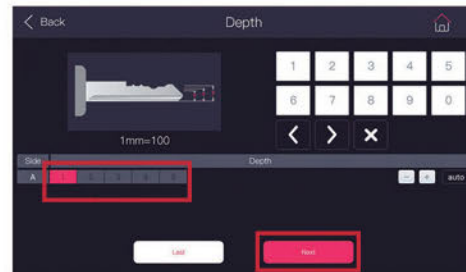

Step 7.

Input the parameters in depth of the key and click "Next" button



Step 8.

Input the parameters in Width and click "Next" button

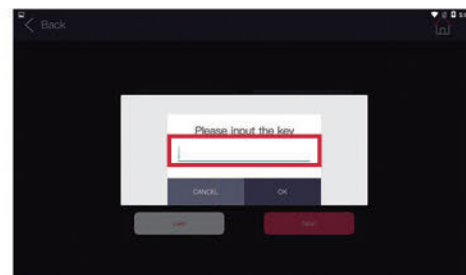

Step 9.

Name the new key data and click "OK" button

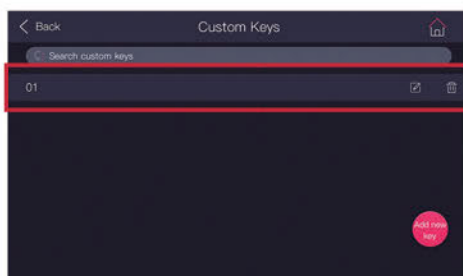

Step 10.

Review the key data you just added

Custom Keys

Single External Groove Key

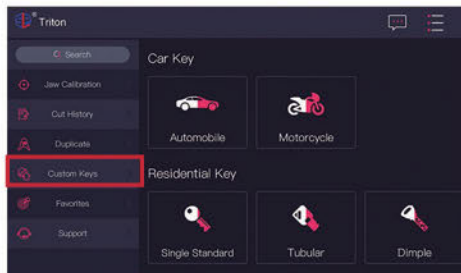

Step 1.

Click "Custom Keys" button on Home Page

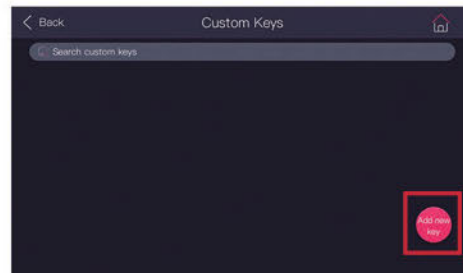

Step 2.

Click "Add New Key" button

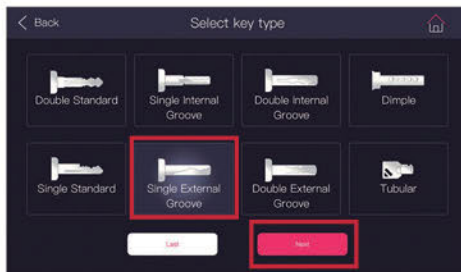

Step 3.

Click "Single External Groove Key" button, then "Next" button

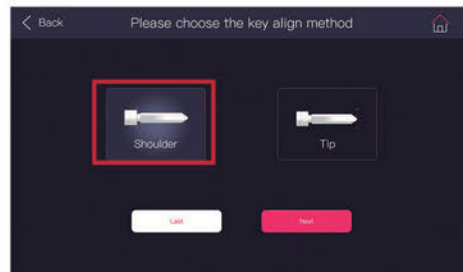

Step 4.

Click "Shoulder" button, then "Next" button

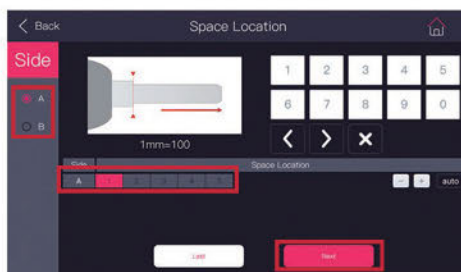

Step 5.

Choose "A" and input the parameters in space location of the key and click "Next" button

Custom Keys

(continued...)

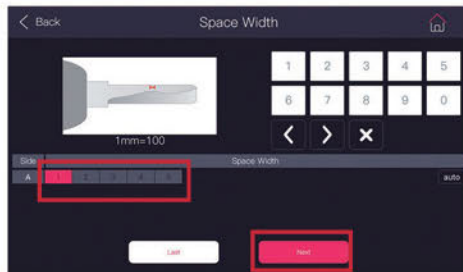

Step 6.

Input the parameters in space width of the key and click "Next" button

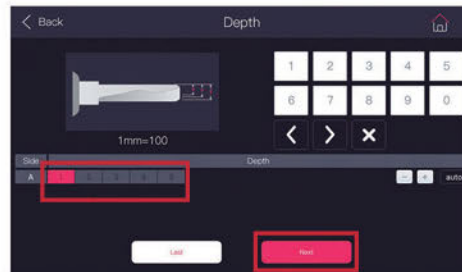

Step 7.

Input the parameters in depth of the key and click "Next" button



Step 8.

Input the parameters in Width, Thickness, Cut Depth, Groove and Nose and click "Next" button

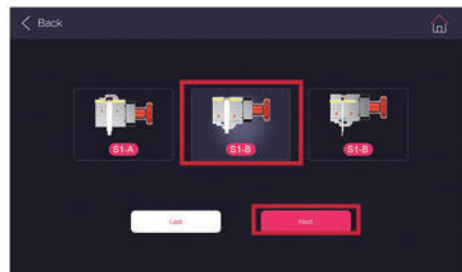

Step 9.

Choose correct "Jaw" and click "Next" button

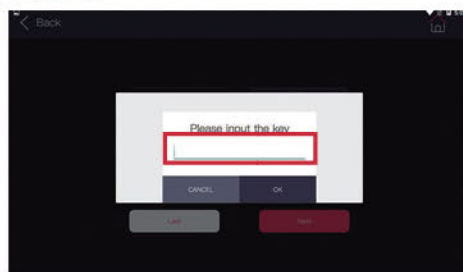

Step 10.

Name the new key data and click "OK" button

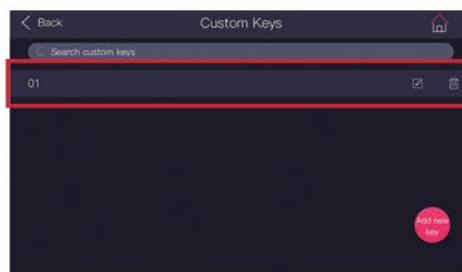

Step 11.

Review the key data you just added

Custom Keys

Double External Groove Key

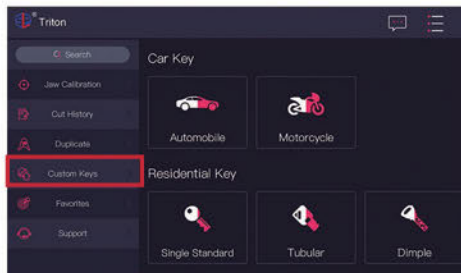

Step 1.

Click "Custom Keys" button on Home Page

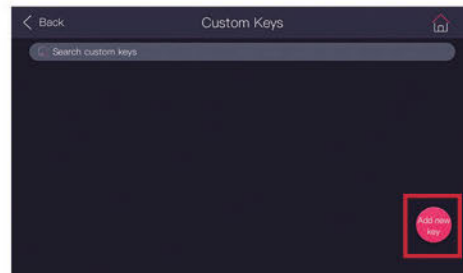

Step 2.

Click "Add New Key" button

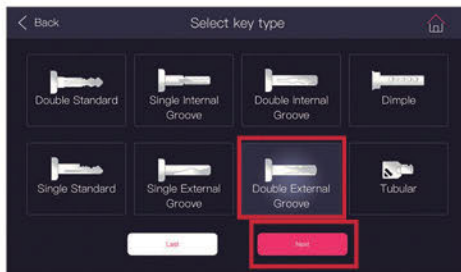

Step 3.

Click "Double External Groove Key" button, then "Next" button

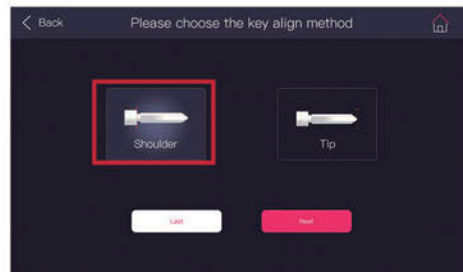

Step 4.

Click "Shoulder" button, then "Next" button

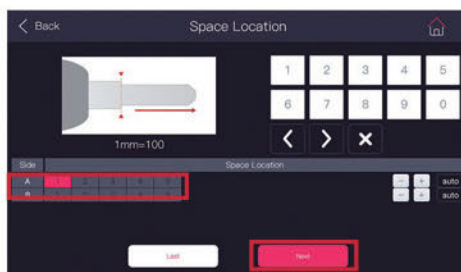

Step 5.

Input the key parameters in the spaces and click "Next" button

Custom Keys

(continued...)

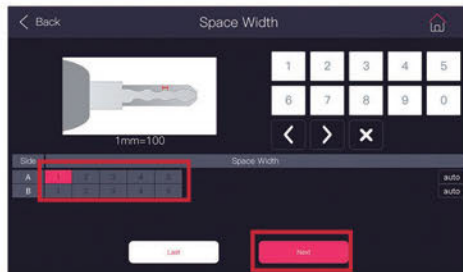

Step 6.

Input the parameters in space width of the key and click "Next" button

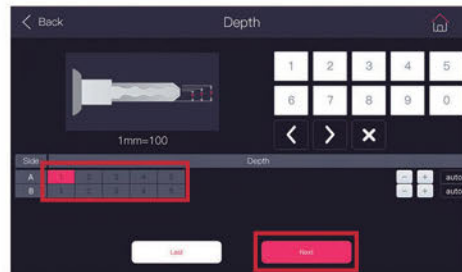

Step 7.

Input the parameters in depth of the key and click "Next" button



Step 8.

Input the parameters in Width, Thickness, Cut Depth and click "Next" button

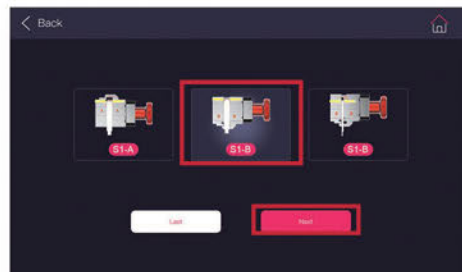

Step 9.

Choose correct "Jaw" and click "Next" button

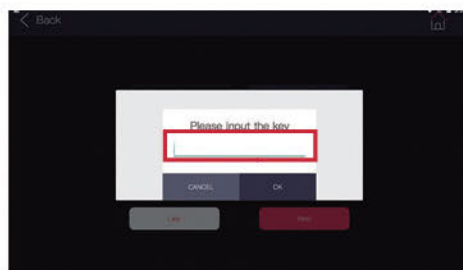

Step 10.

Name the new key data and click "OK" button

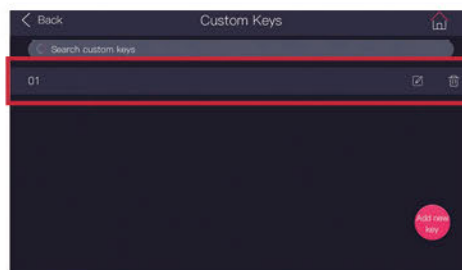

Step 11.

Review the key data you just added

Custom Keys

Tubular Key

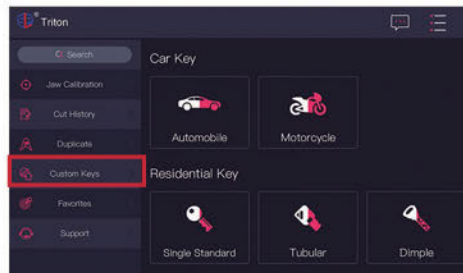

Step 1.

Click "Custom Keys" button on Home Page

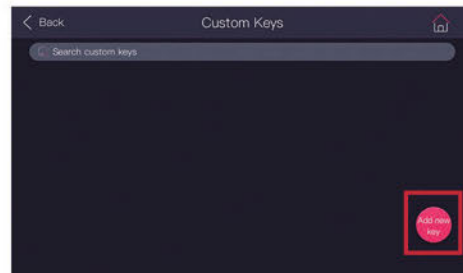

Step 2.

Click "Add New Key" button

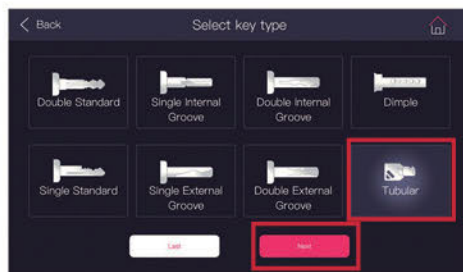

Step 3.

Click "Tubular" button, then "Next" button

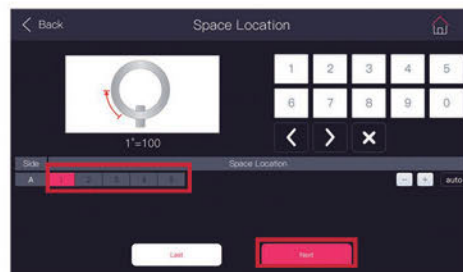

Step 4.

Input the parameters in space location of the key and click "Next" button



Step 5.

Input the parameters in depth of the key and click "Next" button

Custom Keys

(continued...)



Step 6.

Input the parameters in Width, Thickness, Cut Depth and click "Next" button

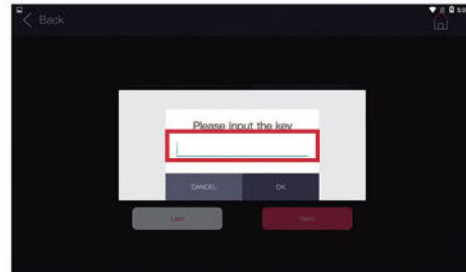

Step 7.

Name the new key data and click "OK" button

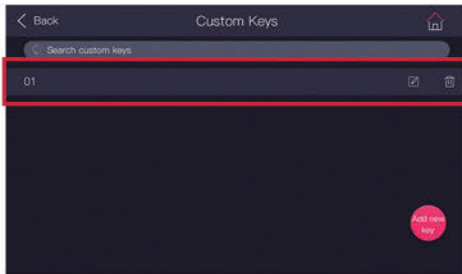

Step 8.

Review the key data you just added

Favorites/Cut History

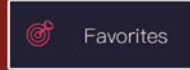

Favorites



You can check what keys you've saved before.



Cut History

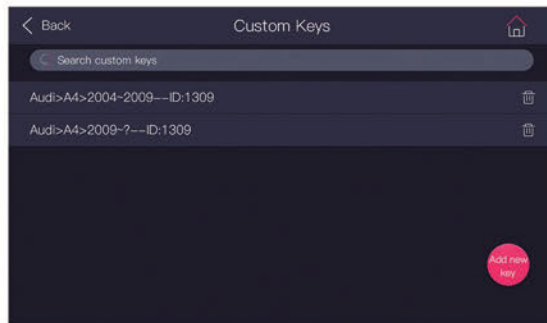

You can check what keys you've cut before.

WIFI Connection

WIFI Connection

Step 1.

Click "Set Up" button on Desktop



Step 2.

Click "WLAN" button

Choose the available WIFI connections shown in the list

Step 3.



Step 4.

Input password and click "Connect" button



Software Activation

Software Activation

Step 1.

Open the software and log in Serial Number and Registration code

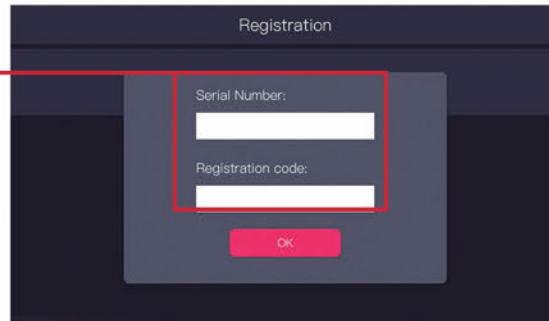

Registration

Serial Number:

Registration code:

OK



Step 2.

Find the label on the back cover of the equipment. The serial number and registration code are there.

Step 3.

Click "OK" button and complete the software activation

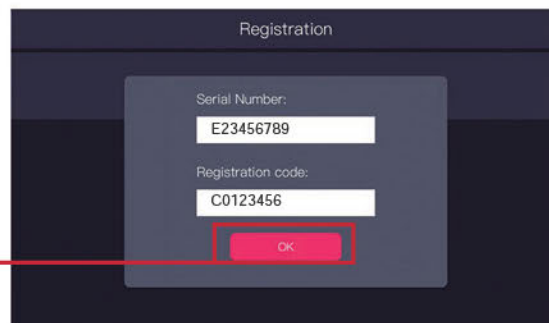

Registration

Serial Number:
E23456789

Registration code:
C0123456

OK

Warranty

LIMITED MANUFACTURER'S WARRANTY

Lock Labs® warrants the Triton Key Cutting Machine™ in compliance with this certificate, in effect for 24 months from the date of purchase. In order to redeem the benefits provided to you by this warranty, **this documentation must be provided in tandem with a verifiable proof of purchase**, as issued by an authorized Triton Key Cutting Machine™ distributor. This warranty covers the free repair or replacement of any parts deemed faulty as a result of manufacturing defects. (For the most current version of this agreement, please visit TritonKeyMachine.com/warranty).

This warranty does **not** cover:

- (1) Damage or malfunctions caused by natural disasters or acts of God (lightning, fire, flood, earthquakes and other external causes)
- (2) Theft, misplacement, reckless, abusive, willful or intentional conduct associated with handling and use of the Triton Key Cutting Machine™
- (3) Faulty installation, repair, or maintenance by anyone other than a Lock Labs® authorized service provider
- (4) Damage to or failure of unauthorized aftermarket upgrades or add-on accessories (This includes the electrical failure of the machine due to the use of inferior or inefficient power inverters)
- (5) Consumer replaceable or consumable items, including but not limited to: cutting bits, tracers (decoders), T-wrenches (Allen wrenches), Allen-slotted threaded bolts, tip stop/calibration block, debris brush and AC power adapter
- (6) Extreme environmental conditions (including extreme temperature or humidity) leading to problems such as external condensation, overheating and mold
- (7) Usage outside of the permitted or intended uses, as described by the manufacturer
- (8) Malfunctions caused by improper operation by machine operator
- (9) Damage caused by insect infestation or rodents
- (10) Covered products that have been reported as lost or stolen
- (11) Any machine whose serial number has been altered, defaced or removed
- (12) Any machine whose software has been modified or altered beyond the normal scope of use
- (13) Damage that is secondary, or any damage that would be ordinarily covered under a primary insurance policy (e.g., car accident causes damage to the Triton Key Cutting Machine™)
- (14) Protection against any other act or result not covered by this plan
- (15) Any resultant damage to the Triton Key Cutting Machine™ that arises from one or more conditions described above

Except for the above cases, all qualifying malfunctions are eligible for free service within the warranty period. To assure your request for service is handled efficiently, please contact Lock Labs® customer service prior to sending us any product. We will issue you a Repair Authorization Form that must be included when shipping your product to us. Failure to do so will result in service delays.

Shipping and Handling Policy: Lock Labs® will contribute to the cost of shipping to and from our repair center, at our discretion, and only within the Continental United States. After preliminary assessment, if your machine malfunction is determined as uncoverable by this warranty, the entirety of all shipping costs will become your obligation. Failure to rectify any outstanding shipping or repair charges **will** result in return shipping delays.

How to Obtain Service and Support

You may obtain service by accessing our website, tritonkeymachine.com/support, or by calling us at (888) 988-6865. Regular business hours are Monday through Friday 8am to 5pm Pacific Standard Time.

To receive service or support, you agree to comply with each of the terms listed below:

- (i) You will provide a copy of this warranty and a copy of your purchase, exchange and service receipts, if requested
- (ii) You will provide, to the best of your ability, information about the symptoms and causes of your issues with the Triton Key Cutting Machine™
- (iii) You will respond to requests for information, including but not limited to: your product serial number, version of the software installed, any peripheral devices connected or installed on the Triton Key Cutting Machine™ key machine, any error messages displayed, the actions which were taken before the Triton Key Cutting Machine™ experienced the issue and the steps taken to attempt resolution of the issue
- (iv) You will follow instructions we give you, including but not limited to refraining from sending us products and accessories that are not subject to repair or replacement service (as listed above) and packing the Triton Key Cutting Machine™ in accordance with the shipping instructions we will provide to you upon service agreement
- (v) **Keep your original packaging!** In the event your machine must be shipped to our repair facility, there is no safer method to ensure that the machine will arrive intact and undamaged, than if it ships in its original box with the original foam inserts. Damages incurred during shipping, due to improper packaging, will be the customer's sole responsibility
- (vi) You will be required to sign a service order disclaimer or other service order terms to obtain repairs or a replacement device. This service order disclaimer or other service order terms do not form a part of this warranty, and are a separate legal document
- (vii) **After** securing permission to send in your machine, please insert your completed Repair Authorization Form inside the box and ship to: Lock Labs Warranty and Repair Center - 2895 W. Capovilla Ave. Suite 100B, Las Vegas, NV 89119

THE LIMITED MANUFACTURER'S WARRANTY IS EXPRESSLY GIVEN AND ACCEPTED IN LIEU OF ALL OTHER WARRANTIES, EXPRESS OR IMPLIED, INCLUDING, WITHOUT LIMITATION, ANY WARRANTY OF MERCHANTABILITY OR FITNESS FOR A PARTICULAR PURPOSE. TO THE EXTENT THAT THEY CANNOT BE DISCLAIMED, THE IMPLIED WARRANTIES ARE LIMITED IN DURATION TO THE LIFE OF THE EXPRESS WARRANTY. LOCK LABS SHALL HAVE NO LIABILITY FOR INCIDENTAL AND CONSEQUENTIAL DAMAGES THAT ARISE FROM THE SALE OF TRITON™ PRODUCTS OR ARE A RESULT OF A BREACH OF THE LIMITED MANUFACTURER'S WARRANTY REPRODUCED ABOVE. THE REMEDIES SET FORTH IN THE LIMITED MANUFACTURER'S WARRANTY ARE THE PURCHASER'S SOLE AND EXCLUSIVE REMEDIES, AND THE ENTIRE LIABILITY OF LOCK LABS FOR ANY BREACH OF THE LIMITED MANUFACTURER'S WARRANTY. SOME STATES/JURISDICTIONS DO NOT ALLOW FOR THE DISCLAIMERS, LIMITATIONS, AND EXCLUSIONS DESCRIBED ABOVE, AND AS A RESULT, THEY MAY NOT APPLY TO YOU. THIS WARRANTY GIVES YOU SPECIFIC RIGHTS, AND YOU MAY ALSO HAVE OTHER LEGAL RIGHTS WHICH MAY VARY FROM STATE TO STATE OR FROM ONE JURISDICTION TO ANOTHER. NO DISTRIBUTOR, DEALER, SALES REPRESENTATIVE NOR ANY OTHER PERSON HAS BEEN AUTHORIZED TO MAKE ANY AFFIRMATION, REPRESENTATION OR WARRANTY REGARDING THE PRODUCT, OTHER THAN THOSE CONTAINED IN THIS LIMITED MANUFACTURER'S WARRANTY, AND IF MADE, SHALL NOT BE ENFORCEABLE AGAINST LOCK LABS. LOCK LABS RESERVES THE RIGHT TO MODIFY THESE TERMS AND CONDITIONS AT ANY TIME, IT BEING UNDERSTOOD THAT SUCH MODIFICATION WILL NOT ALTER THE LIMITED MANUFACTURER'S WARRANTY CONDITIONS APPLICABLE TO THE PRODUCTS SOLD WHILE THESE TERMS AND CONDITIONS ARE IN EFFECT.

TRITON



WWW.TRITONKEYMACHINE.COM



2895 W Capovilla Ave, Suite 100B
Las Vegas, NV 89119

Tel: (855) 562-5522
Email: info@lock-labs.com