

Part #	Part Name
1	Mounting Bracket A
2	Mounting Bracket B
3	Mounting Bracket C
4	Security Guide Bolt
5	Keyed Guide Bolt Receiver
6	Latch Assembly
7	Lock Hood
8	Spindle
9	Strike Assembly A
10	Strike Assembly B
11	Spacers
12	Strike Plate
13	Support Pin
14	Hex Bolts
15	M4 Screws
16	1/2" Self-Tapping Screws (4)
17	1 1/2" Self-Tapping Screws (2)
18	2 1/2" Self-Tapping Screws (2)
19	3/4" Large Phillips Screws (2)
20	Rubber Trim Plate
21	Outside Lock Body
22	Inside Lock Body
23	Flat Head M4 Screws
24	Set Screws
25	Punch
26	Gate Stop

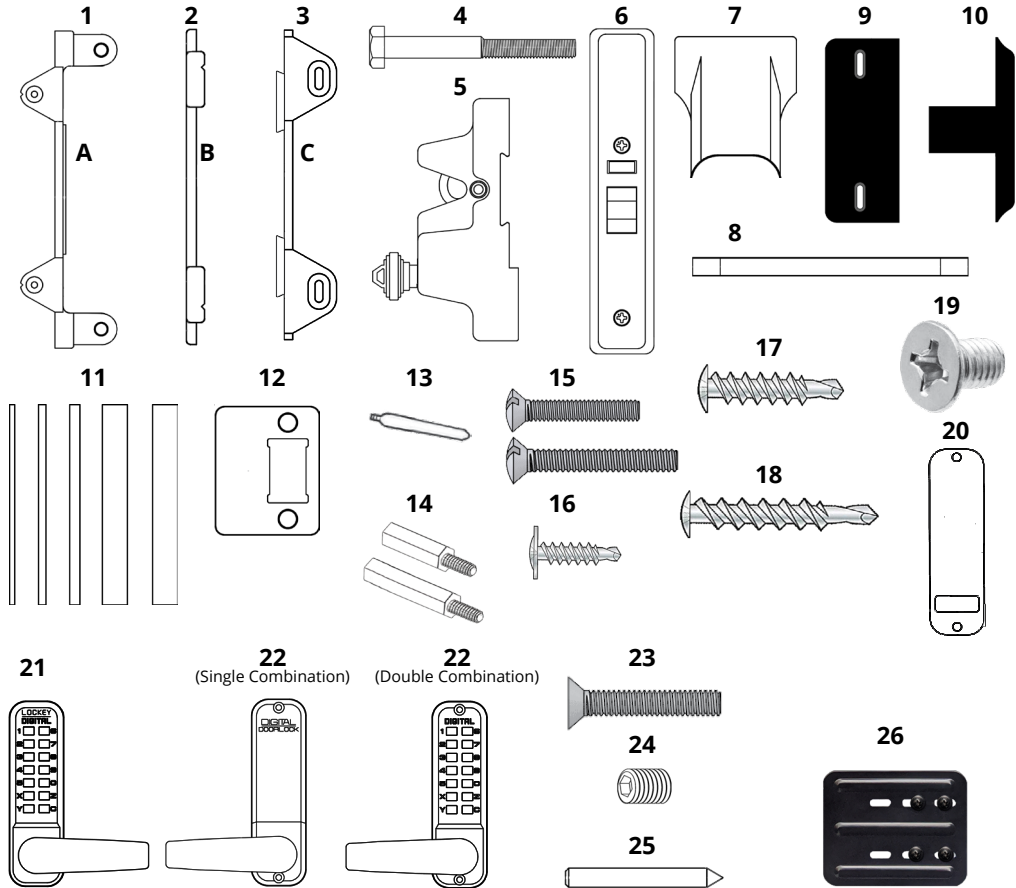

### IMPORTANT INFORMATION ABOUT YOUR SUMO™ GL2 GATE LOCK

- To retain SUMO product warranty, the gate must have a slam prevention device installed. Use of spring closers and/or self-closing hinges without a slam prevention device will void the warranty. LockeyUSA recommends a hydraulic gate closer, such as a TB Series gate closer.
- To retain SUMO product warranty, provided gate stop must also be installed.
- SUMO mounts on left and right hand gates. SUMO Mounting Bracket A must be mounted on the pull side of the gate. Lockout feature works on pull side of gate only. If your gate is an inswing gate, you may want to switch hinges to allow the pull side of the gate to be the exterior or you can simply switch the outside and inside lock bodies when installing.
- SUMO Mounting Brackets must mount flat on the fence and gate posts.

### INSTALLATION INSTRUCTIONS

- Using Mounting Bracket A (#1), identify the desired placement of the SUMO. The two tabs on Mounting Bracket A must mount on the inside edge of the gate.
  - Place Mounting Bracket A in the desired position. Temporarily secure with one 1/2" Self-Tapping Screw (#16) through the center hole on Mounting Bracket A.
  - On the inside of the gate, locate the bottom tab with a notch in it on Mounting Bracket A. Draw a straight line from the bottom notch to the edge of the gate (See Diagram 1).
  - Place Mounting Bracket B (#2) on the opposite side of the gate. Line the bottom notch on the bottom inside tab with the line drawn in Step 1b. (See Diagram 1).
  - Temporarily secure Mounting Bracket B with a 1/2" Self-Tapping Screw through the center hole.
- Insert Security Guide Bolt (#4) into the bottom hole on Mounting Bracket A with the bolt pointing towards the fence post. DO NOT tighten set screw at this time.
- Attach Keyed Guide Bolt Receiver (#5) to the bottom channel of Mounting Bracket C (#3).
 

**Note:** The keyed hook MUST be in the locked position in order to slide the Keyed Guide Bolt Receiver onto Mounting Bracket C. After the Keyed Guide Bolt Receiver is installed on Mounting Bracket C, unlock the receiver.
- Hold Mounting Bracket C with Keyed Guide Bolt Receiver to the fence post. Hold in place until the Security Guide Bolt is centered into the v-groove of the Keyed Guide Bolt Receiver, where the hook is (See Diagram 2). This will center the locks assembly with the strike assembly.
  - Mark the top of Mounting Bracket C with a pencil.
  - Open the gate. Secure Mounting Bracket C to the post with two 1/2" Self-Tapping Screws through the tabs on the inside fence post edge.
  - Close the gate to ensure the Security Guide Bolt and Keyed Guide Bolt Receiver are centered and you are able to lock the security hook.

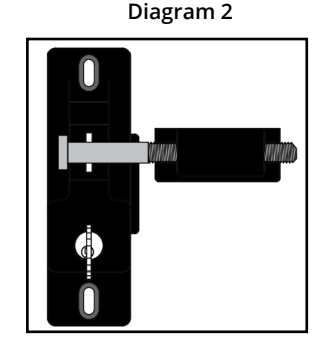
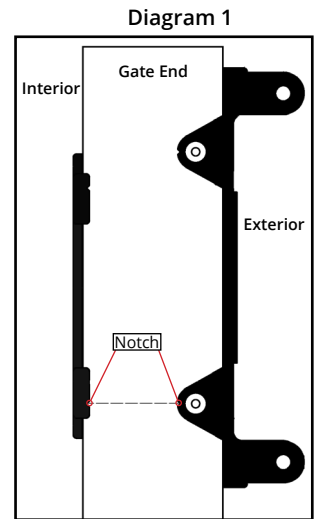
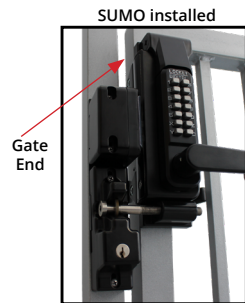

5. Next, adjust Security Guide Bolt for added security.
  - a. With gate closed, adjust the Security Guide Bolt in or out so the end just starts to hit the v-groove of the Keyed Guide Bolt Receiver.
6. Prepare to drill mounting holes (See Diagram 3).
  - a. Mark holes B, C and D on gate through Mounting Bracket A with a marker or pencil.
  - b. Mark holes A, C and D on gate through Mounting Bracket B with a marker or pencil.
7. Remove Mounting Bracket A and B.
  - a. Insert set screw (#24) using the allen wrench into hole on the back side of Mounting Bracket A. Tighten in order to secure Security Guide Bolt into place. Make sure the flat side of the Security Guide Bolt thread is in contact with the set screw.
8. Drill Mounting Holes.
  - a. Choose the proper template for your application, depending on handing (See Diagram 4).
  - b. Cut template on designated line to separate templates for Mounting Bracket A & B.
  - c. Fold each side of the template on the designated line. Place the folds on the edge of the gate & align the bottom horizontal line on the Mounting Bracket A template with the line drawn in step 1b, then tape to gate. Next, align the horizontal lines on the Mounting Bracket B template with the horizontal lines on the Mounting Bracket A template and secure both to gate.
  - d. With the Punch (#25) provided, mark center of mounting holes B, C and D on Mounting Bracket A template and mark the center of mounting holes A, C and D on the Mounting Bracket B template.
  - e. Double check to make sure the holes in the template align with the marks made in step 6.
  - f. Using a 3/8" drill bit, drill holes marked on the gate for B & D from Mounting Bracket A. Drill holes marked on the gate for A & D from Mounting Bracket B.
  - g. Using a 1/2" drill bit, drill holes marked C on both Mounting Brackets A & B.
9. Place Mounting Bracket A onto gate and secure with three 1/2" Self-Tapping Screws (2 screws through the tabs on the inside edge of gate, 1 through center hole used in previous step). Close the gate and check to make sure the Security Guide Bolt and v-groove of the Keyed Guide Bolt Receiver remain aligned. Secure Mounting Bracket B to gate with one 1/2" Self-Tapping Screw through center hole.
10. Once holes are drilled, place Latch Assembly (#6) onto Mounting Bracket A, then slide Lock Hood (#7) over top and secure with two 3/4" Large Phillips Screws (#19).
 

**Note:** To change latch direction, remove face plate. Pull & twist latch head so the rounded edge faces Mounting Bracket B when installed. Re-secure face plate on latch.
11. Install Combination Lock
  - a. Change the combination of your lock if you wish to change it from the code given. Please refer to the how to change code instructions at the end of the instruction document.
  - b. Cut the Spindle (#8) to its correct length by measuring the thickness of your gate post.
 

**Use Chart 1** to determine appropriate spindle length.
  - c. Double check spindle length – place Inside Lock Body (#22) to inside Mounting Bracket B. Place Spindle through Latch Assembly and all the way into the Inside Lock Body. Measure the distance the Spindle sticks out from the Latch Assembly to make sure you have 3/8" – 5/8" showing. **Note:** If your spindle is too short, your lock may not open. If your spindle is too long, your lock may bind and stay unlocked causing the lock to not clear when opened.
  - d. Insert Support Pin (#13) into Outside Lock Body (#21). See Diagram 3 to determine gate handing. For right handed gates, insert support pin in the left hole. For left handed gates, insert into the right hole (See Diagram 4).
  - e. Screw the proper length Hex Bolts (#14) into the Outside Lock Body and place the Rubber Trim Plate (#20) on the inside of the Outside Lock Body.
  - f. With the spindle in place, hold the Outside Lock Body to the Latch Assembly.
  - g. Place Rubber Trim Plate onto Inside Lock Body and hold into place on Mounting Bracket B. Secure Inside Lock Body to Outside Lock Body through the gate with two M4 Screws (#15).
  - h. Install lever handles onto both lock bodies using the two Set Screws. Handles should point towards hinges.

**IMPORTANT:** Your lock should now work. Test your lock by pressing the "C" button followed by your combination. Your lock should now open and retract the latch. Be sure to check both sides to make sure your lock is working properly before installing the strike assembly.
12. You are now ready to mount the strike assembly.
  - a. Slide the Strike Assembly A (#9) onto the top channel of Mounting Bracket C.
  - b. Use the Spacers (#11) and Strike Assembly B (#10) with the Strike Plate (#12) to determine the minimum gap between your gate and fence post. The recommended distance for your gap is 1/8".
  - c. Place Spacers and Strike Assembly B with the Strike Plate into place and secure them with two Flat Head M4 Screws (#23).
13. Test to make sure all lock functions work properly.
  - a. If the lock doesn't work properly, refer to Steps 1 through 12.
  - b. If the lock works properly, advance to the final step.
14. Secure Keyed Guide Bolt Receiver and the Strike Assembly A to the fence post.
  - a. With two 1 1/2" Self-Tapping Screws (#17), secure Keyed Guide Bolt Receiver using the slotted holes.
  - b. With two 2 1/2" Self-Tapping Screws (#18), secure the Latch Strike Assembly using the slotted holes.
15. Install Gate Stop (#26) on the pull side of the gate using the supplied self-tapping screws. Check installation to ensure the Gate Stop makes contact with the fence post when the gate is closed.
16. Your lock is now installed and ready to use. See next page for installed photo of the SUMO.

**Diagram 3**

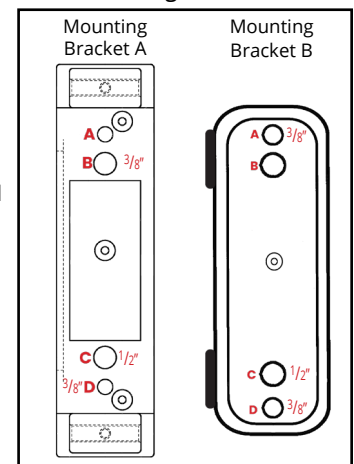
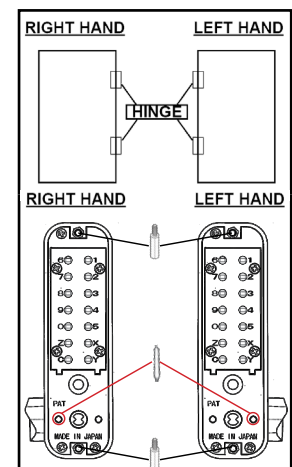

**Chart 1**  
(in inches)

Gate Post Thickness	Spindle Length (Single Combination)	Spindle Length (Double Combination)
1	4.5	4
1.5	5	4.5
2	5.5	5
2.5	6	5.5
3	6.5	6
3.5	7	6.5
4	7.5	7
4.5	8	7.5
5	8.5	8

**For Single Combination locks:**  
Add 3.5" to gate thickness for spindle length  
**For Double Combination (DC) locks:**  
Add 3" to gate thickness for spindle length

**Diagram 4**



Questions?  
Call Technical Support:  
**888.395.0163**  
For added security, M4 Tamper Proof Screws are available at [www.LockeyParts.com](http://www.LockeyParts.com).

SAVE

## How to Change User Code/Combination

1. Using a #2 screwdriver, remove the four (4) Red Screws.
2. Carefully remove cover plate.

**WARNING:** Springs are attached to plate.

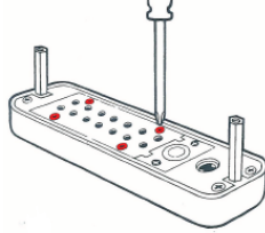

'C' = CLEAR (DO NOT REMOVE)

'Y' = PASSAGE ('Y' Tumbler may be removed to disable PASSAGE FUNCTION)

3. PRESS & HOLD 'C' BUTTON to release tumblers.

**IMPORTANT:** 'C' button *MUST* be pressed and held down when removing and inserting tumblers. Failure to do so will damage the lock and void the warranty.

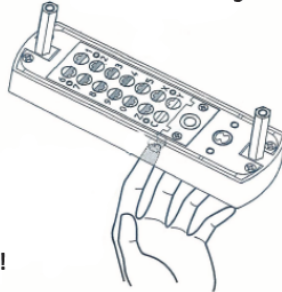

**WARNING:**

Do NOT force tumblers into position!

4. While holding the 'C' BUTTON, remove/add **CODE (Red)** and **NONCODE (Blue)** tumblers to create your desired code.

Ex: 3 Red = 3-Digit Code / 6 Red = 6-Digit Code

5. After changing your code, release the 'C' BUTTON to secure the tumblers in place.

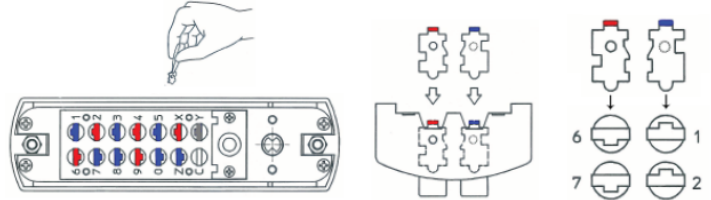

6. Replace the cover plate and secure with four (4) Red Screws, using a #2 screwdriver.

7. TEST CODE before installing/re-installing lock.

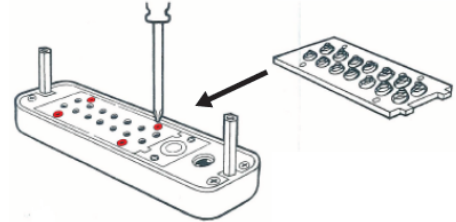

For more helpful tips and installation instructions, visit [www.LOCKEYUSA.com](http://www.LOCKEYUSA.com)

### IMPORTANT INFORMATION ABOUT YOUR SUMO™ GL2

1. When the door is closed, the system locks automatically.
2. From the inside, unlock using the lever handle.
3. From the outside, unlock by pressing 'C' (CLEAR), followed by your User Code.
4. Your lock is equipped with a PASSAGE FUNCTION, allowing you to leave the door unlocked.

**\*\*USING PASSAGE FUNCTION WILL COMPROMISE THE SECURITY OF THIS LOCK\*\***

#### To enable the passage function:

Press 'C' (CLEAR), then 'Y' (PASSAGE), then enter User Code.

#### To disable the passage function:

Press 'Y' (PASSAGE), followed by 'C' (CLEAR).

#### To disable the passage function PERMANENTLY:

Remove the 'Y' (PASSAGE) tumbler, leaving that slot empty.

#### IMPORTANT:

Always press and hold 'C' Button when removing and inserting Tumblers. Refer to 'How to Change Code' instructions above.

### MORE GATE HARDWARE PRODUCTS FROM LOCKEYUSA



#### SUMO™ GATE HARDWARE

Pool/Perimeter Magnetic Gate Latches, Self-Closing Hinges, Gravity Latches



#### SUMO™ GATE CLOSERS

TB100 Turtleback, TB175 Garden Gate Closer, TB200, TB400, TB600 Hydraulic Closers (also available in stainless steel), TB250, TB450, TB650 Adjustable Hydraulic Closers



#### SUMO™ GATE PANIC HARDWARE

Panic Shields, Panic Bars, Panic Trims, Panic Trim Gate Boxes, Strike Brackets, Latch Protectors, Max Guards



#### SUMO™ LINX FOR CHAIN LINK

LINX Gate Boxes for installing LockeyUSA keyless locks on chain link, TB-LINX Adapters for Gate Closers



**SUMO™ GL2 Installed**