



HD-AVS Eyeball Cameras

Quick Start Guide

Table Of Contents

Features and Specifications

- A. Overview 2
- B. Cable Interface 2

Camera Installation

- A. Installation Steps 3-4
- B. Lens Adjustment 4
- C. Waterproofing Connectors 4

FAQ and Lightning Protection

- A. FAQ 5

IMPORTANT SAFEGUARDS AND WARNINGS

Electrical Safety

All installation and operation here should conform to your local electrical safety codes. The power shall conform to the requirement in the SELV (Safety Extra Low Voltage). Please check product specifications for power requirements. We assume no liability or responsibility for all the fires or electrical shock caused by improper handling or installation. We are not liable for any problems caused by unauthorized modification or attempted repair.

Transportation Security

Care must be given to avoid heavy stress, violent vibration or water damage during transportation, storage and installation.

Installation

Do not apply power to the camera before completing installation. Please install the proper power cut-off device during the installation connection. Always follow the instruction guide the manufacturer recommended.

Qualified engineers needed

All the examination and repair work should be done by the qualified service engineers. We are not liable for any problems caused by unauthorized modifications or attempted repair.

Environment

This series network camera should be installed in a cool, dry place away from direct sunlight, inflammable, explosive substances and etc. Please keep it away from the electromagnetic radiation object and environment. Please make sure the CCD (CMOS) component is out of the radiation of the laser beam device. Otherwise it may result in CCD (CMOS) optical component damage. Please keep the sound ventilation. Do not allow the water and other liquid falling into the camera. Lightning-proof device is recommended to be adopted to better prevent lightning damage. The grounding studs of the product are recommended to be grounded to further enhance the reliability of the camera.

Daily Maintenance

Please shut down the device and then unplug the power cable before you begin daily maintenance work. Do not touch the CCD (CMOS) optic component. You can use the blower to clean the dust on the lens surface. Always use the dry soft cloth to clean the device. If there is too much dust, please use the water to dilute the mild detergent first and then use it to clean the device. Finally use the dry cloth to clean the device. Please put the dustproof cap to protect the CCD (CMOS) component when you do not use the camera.

Accessories

Be sure to use all the accessories recommended by manufacturer. Before installation, please open the package and check all the components are included. Contact your local retailer ASAP if something is broken in your package.



1A. OVERVIEW

This series Eyeball style camera utilizes High Definition Advanced Video System (HD-AVS) technology, an HD-over-coaxial cable video standard that allows long-distance, HD transmission of video, audio, and control functions. Most camera models support CVBS with an additional output.

The camera supports the IR night vision function. In the night environments, the device can use the IR light to highlight the object which is suitable for the surveillance function in the low illumination environments. The waterproof design conforms to the IP67 level and some models offer IK10 rating, thus is suitable for use in outdoor environments.

1B. Cable Interface

See Figure 1-1 for cable interface identification. Outputs may vary depending on model.

1. DC Power input (please see your specific model's power requirements)
2. Video output
3. Audio input (RCA)
4. Dip Switch (Changes video formats eg: CVBS, AVS, TVI)

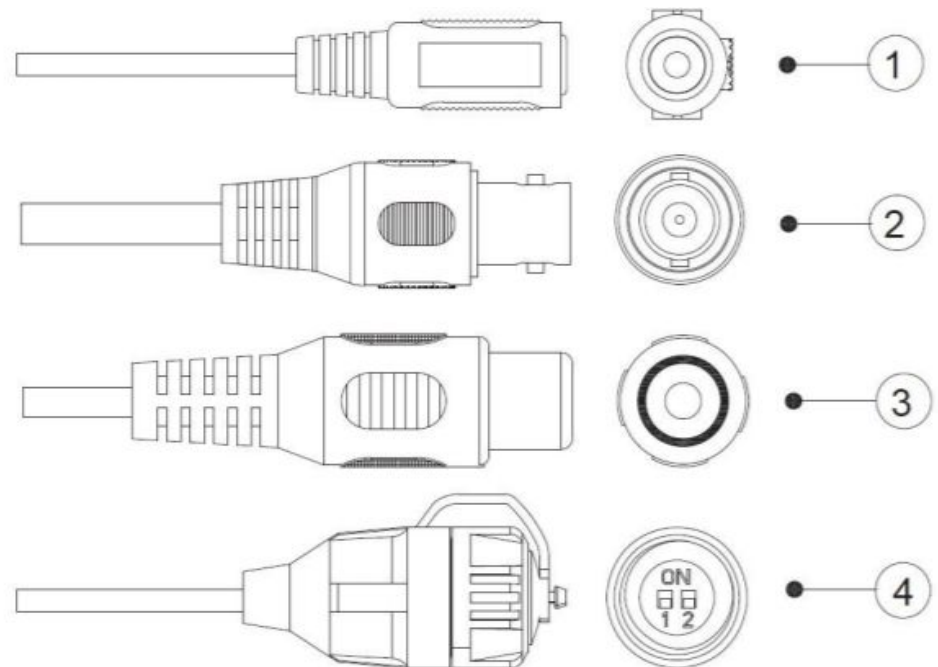

Figure 1-1

2A. INSTALLATION STEPS

Step 1 Separate the mounting base from the camera. Some models feature a set screw that must be loosened or locking tabs that need to be lined up for disassembly of the camera. See Figure 2-1 for examples.

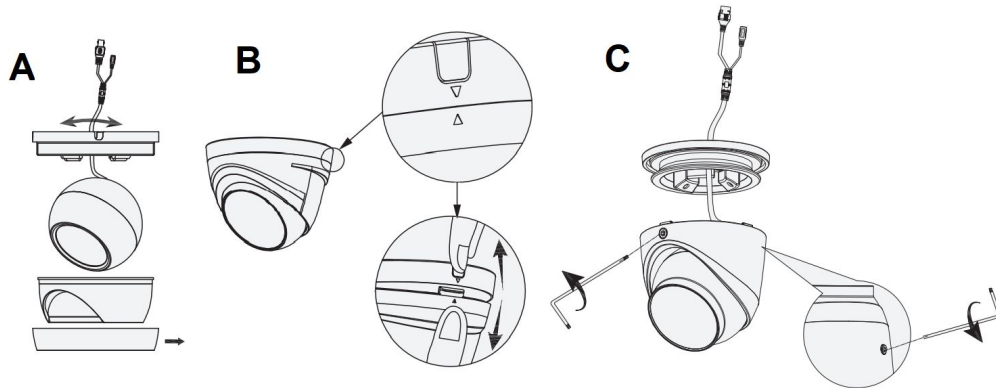

Figure 2-1

Step 2 Use the included position map and drill the appropriate mounting holes and cable exit, if necessary. See Figure 2-2.

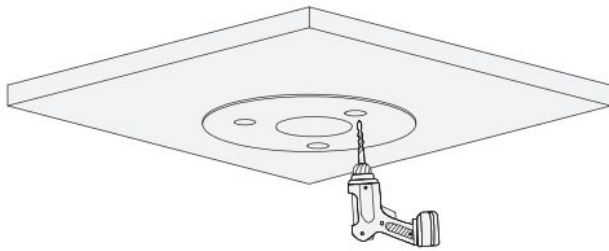

Figure 2-2

Step 3 Install the expansion screws. See Figure 2-3.

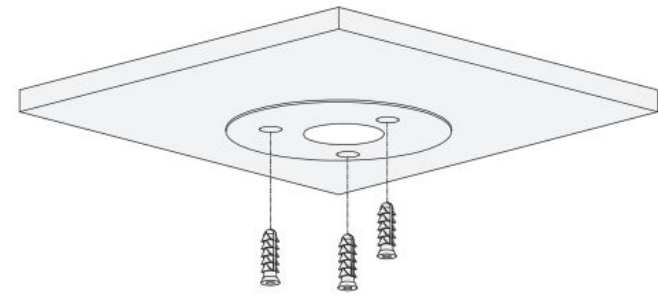

Figure 2-3

Step 4 Install the base to the mounting surface as shown by threading the installation screws through the base and expansion screws as shown in Figure 2-4.

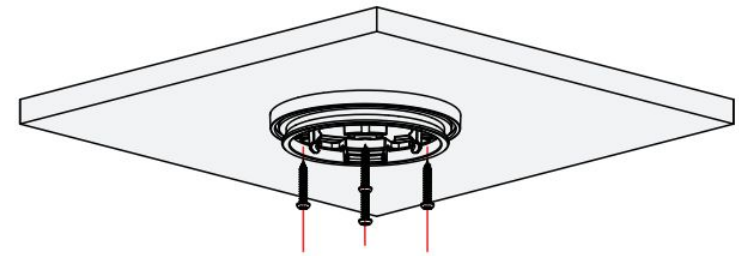

Figure 2-4

Step 5 Thread the cabling through the mounting surface if necessary and install the dome cover with the camera body to the base. See Figure 2-5 for examples.

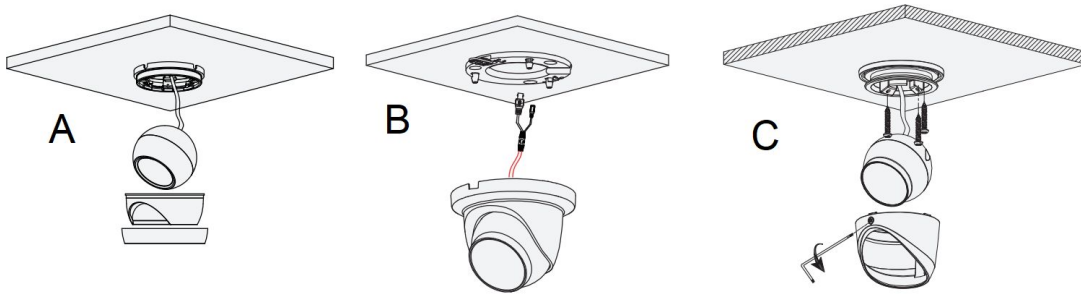

Figure 2-5

2B. Lens Adjustment (available in some models)

Some models feature a zoom and focus adjustment. Locate the adjustment knobs as shown in Figure 2-7.

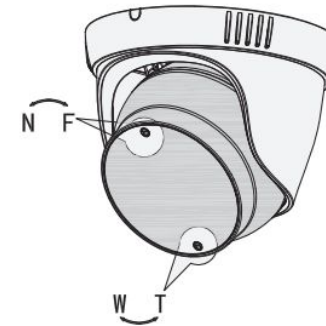

Figure 2-7

Step 6 Some models feature a set screw to secure the camera assembly. Loosen the screw to allow movement of the camera body. Tighten screw when the camera is set to proper angle. See Figure 2-6 for examples.

2C. Waterproofing Connectors

For outdoor installations, waterproofing the connectors is necessary. See Figure 2-8.

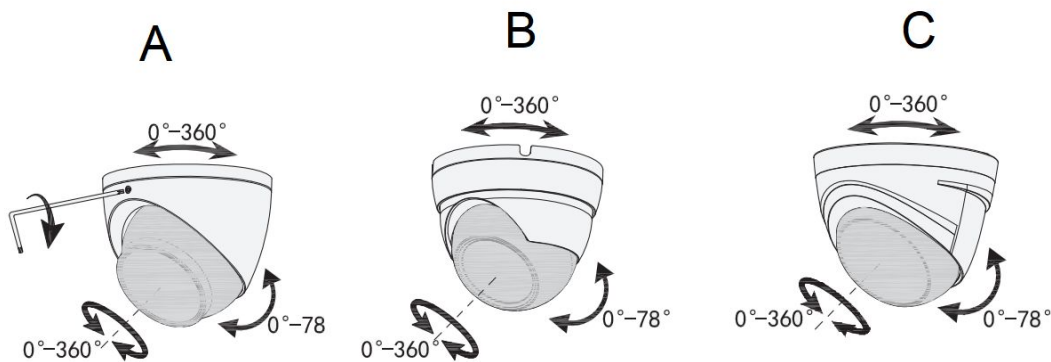

Figure 2-6

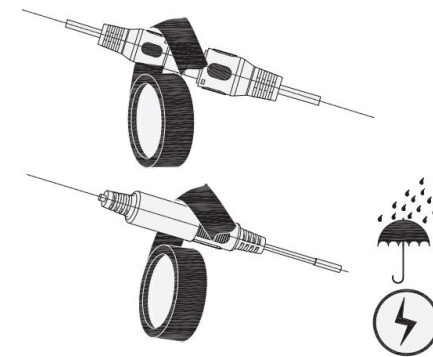

Figure 2-8

3A. FAQ

No image after the Device is powered on	<ul style="list-style-type: none">• Check whether the power supply is properly connected.• Check recorder video format and resolution compatibility with Camera• Check whether the main power and transformer are working normally.
Image is black and white	<ul style="list-style-type: none">• Use the required power supply.• Check recorder compatibility with Camera video format
Cannot control zoom/ focus through the recorder	<ul style="list-style-type: none">• Insufficient power, use the required power supply,• Ensure PTZ settings on Recorder is set to AVS protocol for that channel
Image is not stable	<ul style="list-style-type: none">• Poor contact on circuits. Connect the cable properly.
Blurry image.	<ul style="list-style-type: none">• Lens glass is dirty. Clean the lens.• Focus is in manual mode. Set Focus settings.