

1 Description

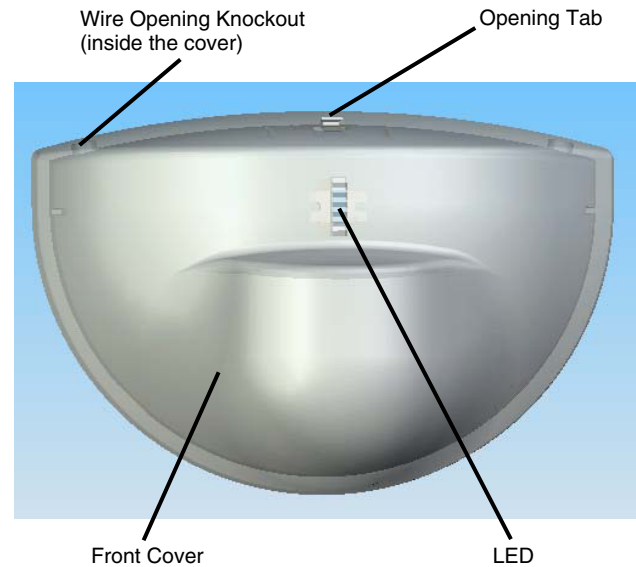
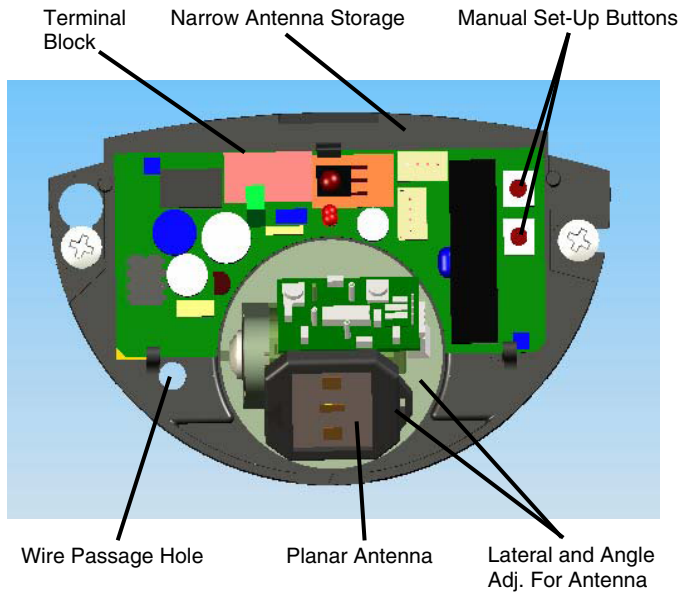

2 Technical Specifications

DESCRIPTION	SPECIFICATION
Frequency:	24.125 GHz
Supply voltage:	12 to 24 V AC: $\pm 10\%$ 12 to 24 V DC: -10% / $+30\%$
Mounting height:	Normal: 7'; Maximum: 10'-0"
Tilt angle:	0° to 90° vertical -15° to +15° lateral
Detection area:	
Wide	13ft (W) x 6.5ft (D)
Narrow	6.5ft (W) x 8.2ft (D) (supplied as optional)
Minimum detection speed:	2 in/sec. (measured in axis)
Power consumption:	< 2 W
Standard output relay:	
Max contact voltage	60 VDC / 125 VAC
Max contact current	1 A (resistive)
Max switching power	30W (DC) / 60VA (AC)
Hold time:	0.5 sec. to 9 sec. (adjustable)
Temperature range:	-4°F to 131°F
Dimensions:	4.75in (W) x 3.15in (H) x 2.0in (D)
Weight:	0.5lbs
Material:	ABS
Housing color:	Black. Can be painted with non-metallic paint
Cable length:	6ft

3 Installation

1 Tips

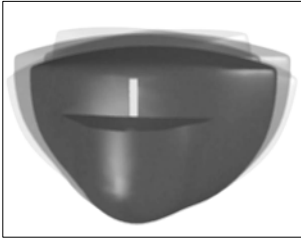

The sensor must be firmly fastened to prevent vibration.



The sensor must not be placed directly behind a panel or any kind of material.

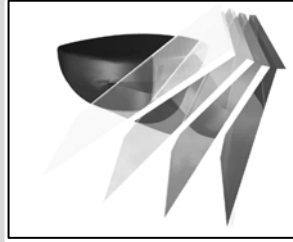

The sensor must not have any object likely to move or vibrate in its sensing field.

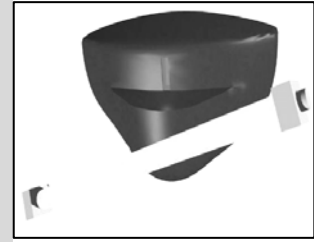

The sensor must not have any fluorescent lighting in its sensing field.

2 Safety Precautions

- Shut off all power going to the header before attempting any wiring procedures.
- Maintain a clean & safe environment when working in public areas.
- Constantly be aware of pedestrian traffic around the door area.
- Always stop pedestrian traffic through the doorway when performing tests that may result in unexpected reactions by the door.
- Always check placement of all wiring and components before powering up to insure that moving door parts will not catch any wires and cause damage to equipment.
- Ensure compliance with all applicable safety standards upon completion of installation.

ELECTROSTATIC DISCHARGE (ESD) PRECAUTIONS



Circuit board components are vulnerable to damage by electrostatic discharge (ESD). ESD can cause immediate or subtle damage to sensitive electronic parts. An electrostatic charge can build up on the human body and then discharge when you touch a board. A discharge can be produced when walking across a carpet and touching a board, for example. Before handling any board, make sure you dissipate your body's charge.

CAUTION: In the event a unit needs to be opened, observe the following precautions.

Ground yourself by touching a conductive surface of the door or other element connected to common earth ground to discharge the static electricity present in your body.
Avoid walking around while replacing items inside the case, especially if you are on carpet or during conditions of low temperature and low humidity.
Handle the board by the edges only to avoid touching electronic components.
Store a loose board in an anti-static bag.

3

Mechanical Installation

Opening the sensor

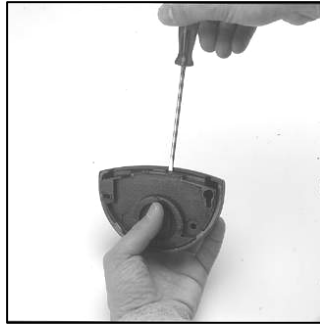

❑ From behind, before installation

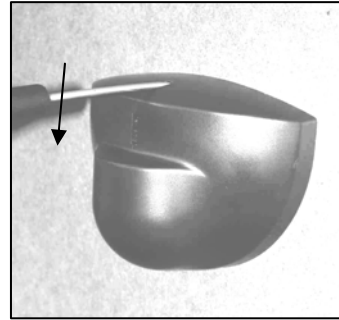

❑ From the front, after installation

Mounting the sensor

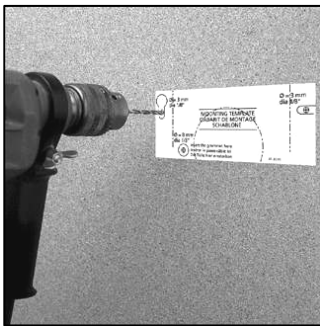

- ❑ Paste the template at desired location.
- ❑ Drill as instructed.

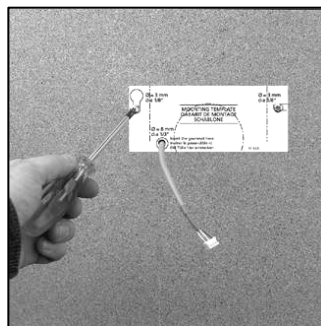

- ❑ Insert screws but do not screw them fully in.
- ❑ Pass the cable where indicated.

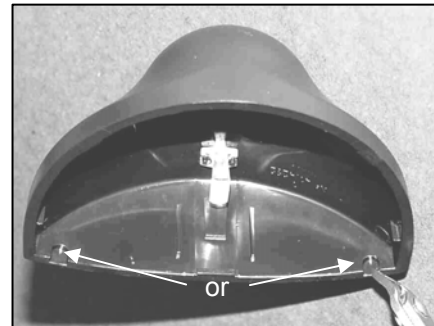

- ❑ Optional cable routing: Notch the cover as shown in the picture.

4

Electrical Installation

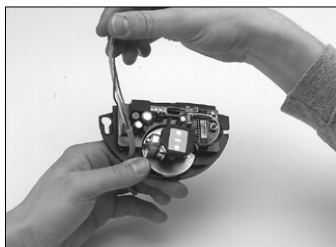

- ❑ Run the cable through the wire passage hole just below PCB.

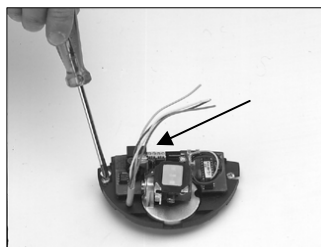

- ❑ Position the sensor and tighten the two screws. Make sure you leave enough cable to reach the terminal block near the top of the sensor.

Terminal	Connection
1 (Red)	12 to 24 VAC / DC (+)
2 (Black)	12 to 24 VAC / DC (-)
3 (White)	Relay Common
4 (Green)	Relay N.O.
5	Relay N.C.

Note: Input power tolerance is +/- 10% for AC, and -10% to +30% for DC power.

- ❑ Wiring connections are as shown above.

5

Mechanical Adjustments

A. THE WIDTH OF THE SENSING FIELD IS DETERMINED BY THE CHOICE OF THE PLANAR ANTENNA (OPTION)

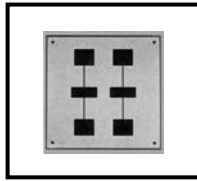
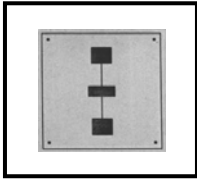

Wide sensing field: 3-element antenna	Narrow sensing field: 6-element antenna
--	--

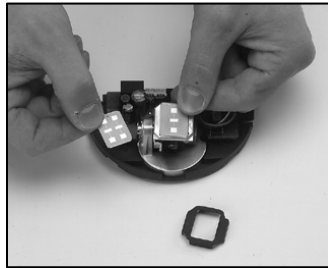
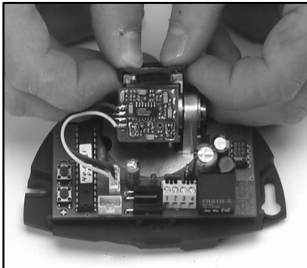

Carefully remove the protective cover of the antenna with a screwdriver.	Change the antenna and replace the protective cover.
--	--

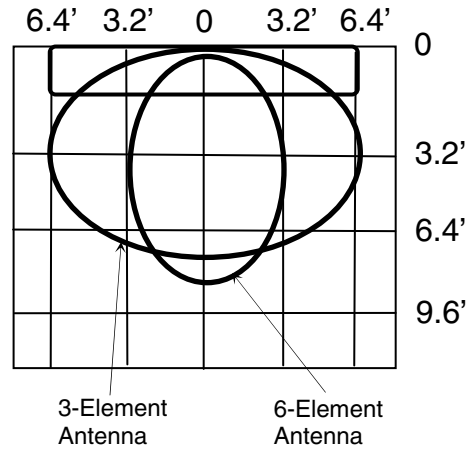

SENSING FIELDS ACCORDING TO THE TYPE OF ANTENNA

The sensing fields above correspond to the following adjustments:
 vertical angle of the antenna: 30°
 sensitivity: 9
 Mounting height: 7'

B. THE POSITION OF THE SENSING FIELD IS DETERMINED BY THE VERTICAL TILT ANGLE OF THE ANTENNA

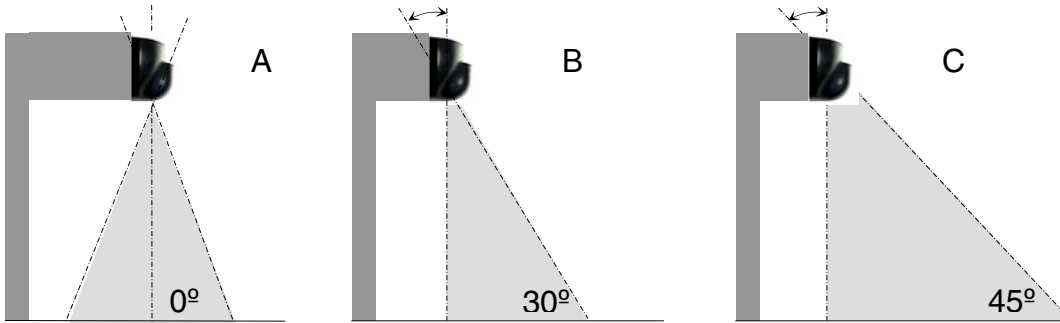

Sensing field as close to the door as possible: -antenna set at the position of 0°	Sensing field close to the door: -antenna set at the position of 30°	Sensing field far from the door: -antenna set at the position of 45°
---	---	---

SENSING FIELDS ACCORDING TO THE VERTICAL TILT ANGLE OF THE ANTENNA

The sensing fields on the right correspond to the following adjustments:

wide sensing field antenna
 vertical angle of the antenna: 0°, 20°, 45°
 sensitivity: 9
 Mounting height: 7'

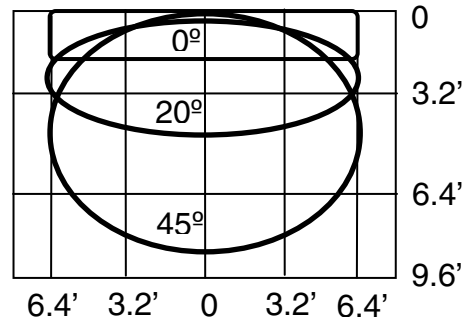

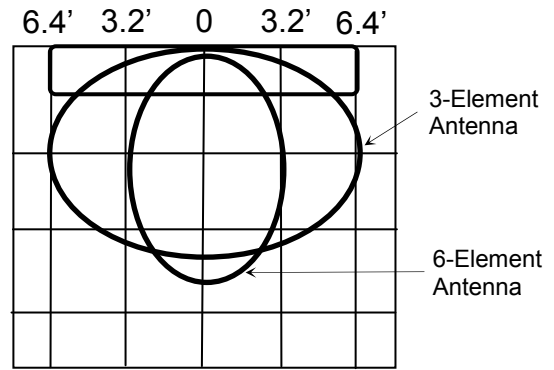
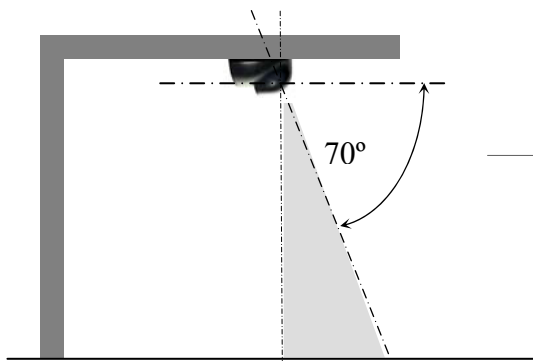

- ❑ For ceiling mounting, the vertical tilt angle of the antenna must be set at the maximum position of 70-75° and the spherical part of the sensor must be oriented in the opposite direction to the door.

SENSING FIELDS – CEILING MOUNT

The sensing fields above correspond to the following adjustments:

- ❑ Vertical angle of antenna: 70°
- ❑ Sensitivity: 9
- ❑ Mounting height: 7'

C. THE LATERAL POSITION OF THE SENSING FIELD IN FRONT OF THE DOOR IS DETERMINED BY THE LATERAL TILT ANGLE OF THE ANTENNA.

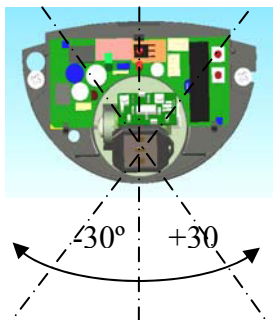

The sensing fields on the right correspond to following adjustments:

- Wide sensing field antenna
- Lateral angle of the antenna: +30°, -30°
- Sensitivity: 1 = min., 6 = middle, 9 = max.
- Mounting height: 7'

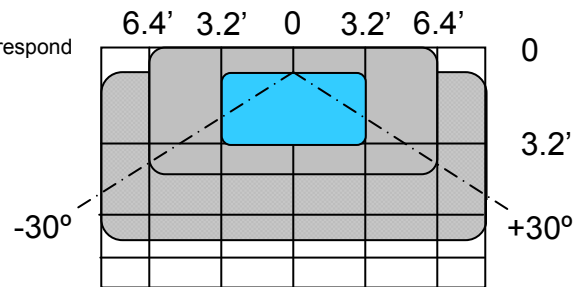

D. THE DIMENSIONS (WIDTH, DEPTH) OF THE SENSING FIELD DEPEND ON THE SENSITIVITY SETTING.

The sensing fields on the right correspond to the following adjustments:

- Wide sensing field antenna
- Vertical angle of the antenna: 30°
- Mounting height: 7'

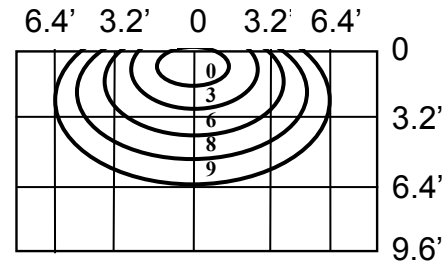

E. THE DIMENSIONS (WIDTH, DEPTH) OF THE SENSING FIELD DEPEND ON THE MOUNTING HEIGHT

The sensing fields on the right correspond to the following adjustments:

- Wide sensing field antenna
- Vertical angle of the antenna: 20°
- Sensitivity: 9
- Mounting height: 9.6'

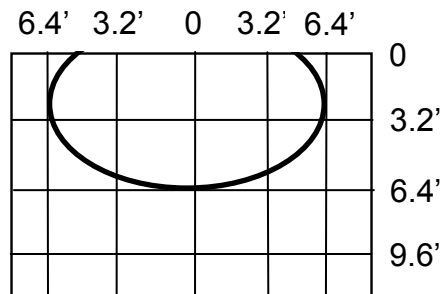

6 Programming Guide

The 663 is equipped with a Motion Tracking Feature (MTF). The MTF is available when the 663 is used in the uni-directional mode. The 663 is factory preset with the MTF ON. MTF is recommended for use in short vestibule areas to help reduce unwanted door hold-open time. Refer to the Programming Guide to alter this setting. Recommendation: keep the MTF enabled for all applications. The detection capabilities perform as follows:

BI-DIRECTIONAL MODE:

- Detection of all motion towards or away from the sensor.

UNI-DIRECTIONAL MODE:

- The detector will work in a uni-directional mode at all times regardless of traffic patterns - detecting only motion moving toward the sensor.

OR

UNI-DIRECTIONAL MODE WITH MTF: The principle is as follows:

- The detector does NOT activate its relay as long as it detects movement exclusively moving away from the detector. It acts like the classic unidirectional detector.
- As soon as the 663 detects movement toward the sensor, it automatically switches to bi-directional mode.
- The 663 maintains the bi-directional function for approximately 2 seconds following the last detection of motion toward the door.
- At the end of the 2-second time frame, if the 663 does not detect any further motion, it switches back to the unidirectional mode.



Number Keys

Number keys (0 through 9) are used for assigning a value for a given function

Unlock 

Inquire 

Lock 

To UNLOCK the sensor:
Press the UNLOCK key once. Red LED flashes quickly

To LOCK the sensor:
Press the LOCK key twice, OR press once then followed by a 4-digit lock code. If less than 4 digits, press lock again after the last digit. LED goes out when complete.

To INQUIRE the sensor:
Unlock the sensor, press the desired function key, followed by the INQUIRY key – the number of green flashes corresponds to the value.

Default: 0000

Adjustment Keys

Plus (+) and minus (-) keys are used for incremental adjustments to the sensor

Relay Configuration

The relay configuration has 4 possible output values:

- 1= Normally Open Relay
- 2= Normally Closed Relay
- 3=Continuous Detection
- 4=Continuous Non-Detection

Default: 1

Default Values

After pressing the DEFAULT VALUE key, the red LED flashes quickly. After pressing a number button, the red LED flashes slowly.

- 1 = Normal Mounting Height (only for serial numbers lower than 84000)
- 2 = Boost Mode, increases sensitivity for high mount applications.
- 9 = Restore default values except lock code (for serial number 84000 and greater)

Sensitivity

0 = Minimum Sensitivity
9 = Maximum Sensitivity

Default: 8

Detection Mode

Detection mode offers 3 different levels of detection:

1 = Bi-Directional
2 = Uni-Directional
3 = Uni-Directional with motion tracking feature

Default: 3



Relay Hold Time

Relay hold time refers to the hold time on the output relay of the 663. Values range from 0 to 9.

0 = .5 sec.

1 = 1 sec through 9 = 9 sec in 1 second intervals

Default: 0

Immunity

Immunity helps to reduce the chance of unwanted detections due to environmental disturbances.

1 = Reduced

2 = Normal

3 = Increased

4 through 9: enhanced immunity (for highly reflective environment)

Default: 2

* Every adjustment, when using the infrared remote control, must start with the unlocking function, and end with the locking function.

7 Manual Setup

If a remote control is not available, only the sensitivity parameter can be adjusted manually, by means of the push buttons **+** (Plus) and **-** (Minus).

The sensor parameters that are not accessible manually will remain at the factory preset values.

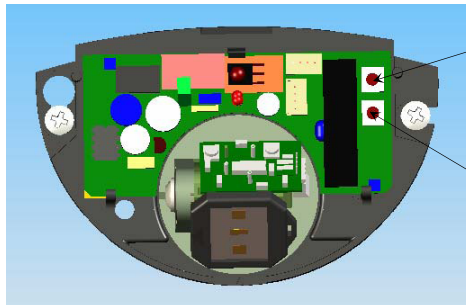

+ Press to increase sensitivity by one unit.

- Press to decrease sensitivity by one unit.

Pressing the two push buttons located on the circuit board, simultaneously for at least two seconds, will restore all default values except the lock code. Previously set lock codes will be retained.

4 Troubleshooting

SYMPTOMS	PROBABLE CAUSE	CORRECTIVE ACTION
The door will not open and no red LED lights up.	The sensor power is off.	Check the wiring and power supply.
	The door control is set to level 3.	Set door control to automatic mode (level 1).
The door opens and closes constantly.	The sensor "sees" the door moving When closing the door creates vibrations picked up by the sensor.	Increase the tilt angle and/or reduce the sensitivity and/or increase the immunity. Ensure the sensor is correctly fixed. Switch to unidirectional mode. Increase the immunity. Reduce the sensitivity.
The door will not close the. Red LED off.	On Off switch at door control in wrong position or is faulty. Improper output configuration on the sensor.	Check to insure On-Off switch for door is in the ON or AUTOMATIC position. Check the output configuration setting on each sensor connected to the door operator.
It rains and the sensor detects for no apparent reason.	The sensor detects the motion of the raindrops.	Use the ERA accessory. Switch to unidirectional mode (without MTF) and increase the immunity.
In airlock vestibules, the sensor sees the opposite door.		Increase immunity.
In airlock vestibules, the sensor sees the movement of the door leaves, despite of an increased immunity.		Make sure the antenna for the narrow sensing field is used.
In metallic environments, the sensor detects objects outside its detection field.		Increase immunity.
The sensor will not unlock when access code is entered.	Batteries in the remote control are weak or installed improperly. Remote control improperly pointed.	Check the batteries insertion. Change the batteries. Point the remote control toward the sensor.

5 Company Contact



Norton® is a registered trademark of Yale Security Inc., an ASSA ABLOY Group company.
Copyright © 2009, Yale Security Inc., an ASSA ABLOY Group company. All rights reserved.
Reproduction in whole or in part without the express written permission of Yale Security Inc. is prohibited.