

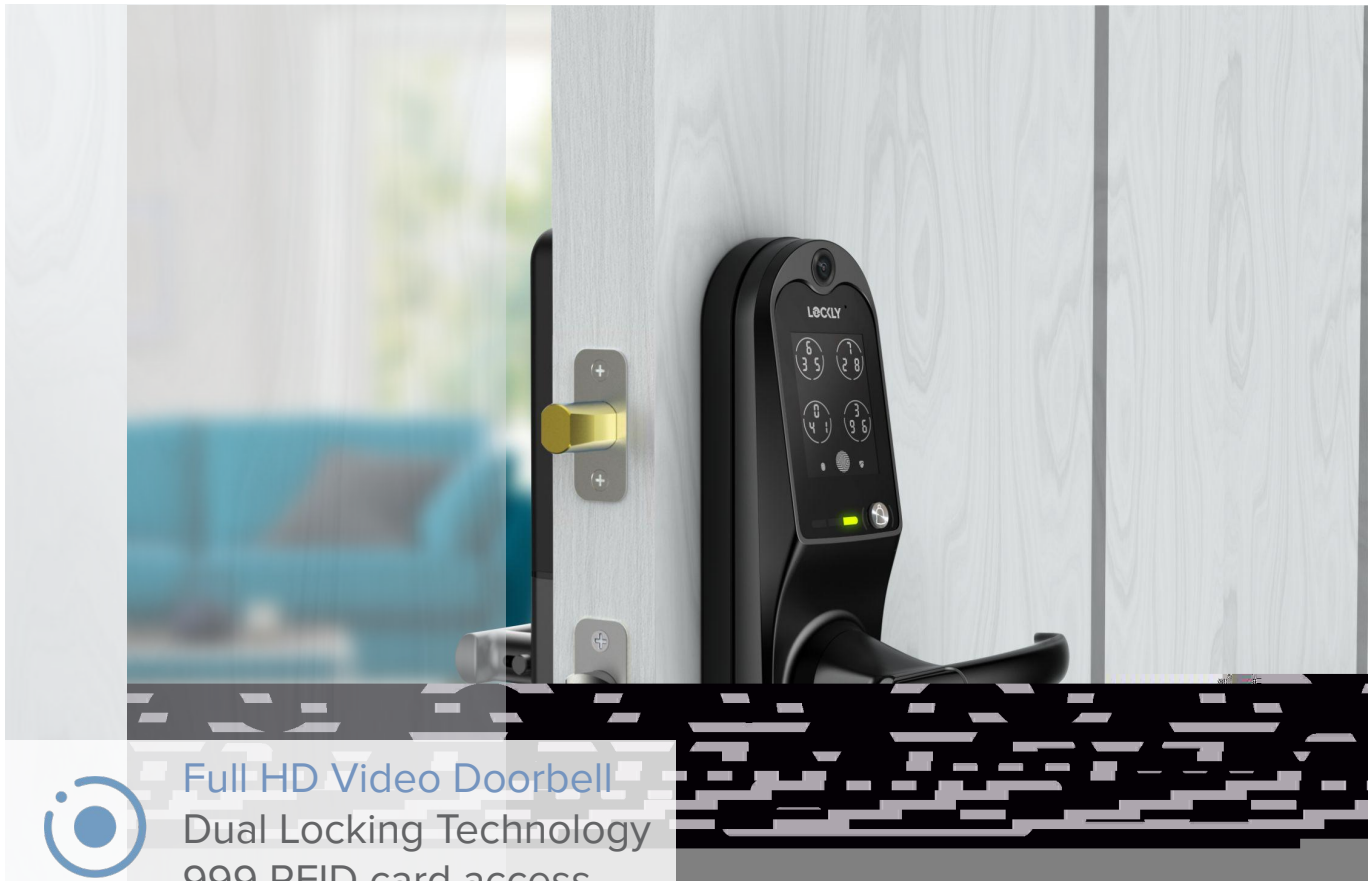

LOCKLY GUARD[™] VISION DUO 698D

Video Doorbell Interconnected Edition



Full HD Video Doorbell
Dual Locking Technology
999 RFID card access

Secure and manage what's most important to you. The integrated Doorbell and Full HD video camera allows you to enjoy the freedom of remotely seeing who's at your front door in real-time, warmly greet and let them in from anywhere in the world with the most secure interconnected deadbolt & latch lockset designed for dual bore holes or as replacement for existing mortise.



Multifamily



Residential



BnB/Rental

- Front doors
- Home office
- Back doors
- Storage Rooms
- Cabins
- And more



Hack-proof digital Keypad
Generate and stores up to 52 access codes with specific profiles and permissions



RFID / Fob Key Access
Fast and secure access, stores up to 999 fob keys or RFID cards.



Mobile App Control
Unlock, lock, or check door on your smartphone

Features and benefits



Full HD video camera
Streams real time video to your smartphone



Doorbell with 2-way audio
Greet guests in real-time from smartphone from anywhere in the world



100M+ accesses granted
Most trusted fingerprint sensor smart lock



Hack-proof Keypad
Patented PIN Genie® shuffling the keypad numbers



Dual Locking Technology™
Lock or unlock interconnect deadbolt & latch with a single motion



Wi-Fi alerts and control
Get status, alerts, and control from anywhere



MIFARE RFID or Fob key
Fast, easy and secure access



Weatherproof
IPX4 works in -4°F to 151°F (-20°C to 66°C)



Re-key capable
Replace the key not the lock with standard re-key kit



Smartphone control
Open/close, share, or revoke access with others

Property management

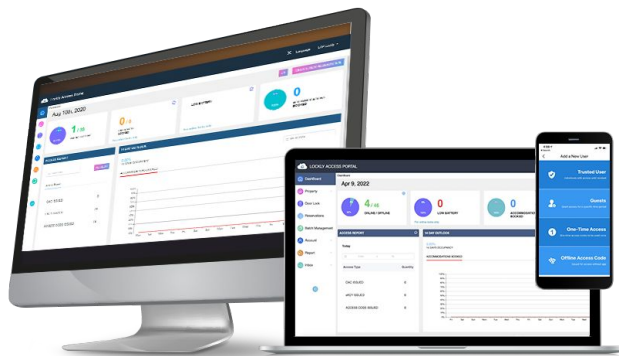

See the big picture from here

Works with Lockly\OS Total Access a full property management system of software, products, and services designed to allow you to view and control where, when, and by whom your property's being accessed from anywhere in the world.



Installation



Professional Installation Recommended

This product can be easily installed by advanced DIYers. It will only take a few minutes if pre-existing bore holes exist. It is recommended to contact a professional installer if drilling new holes is required.

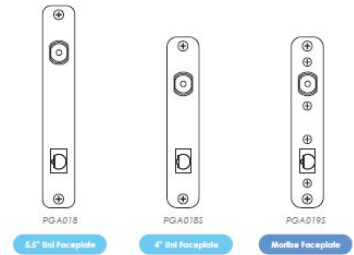
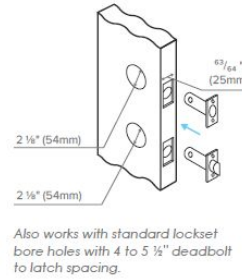
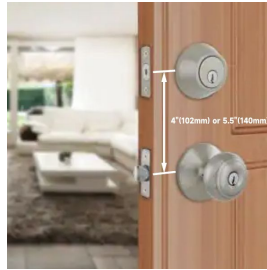



Download installation guide



Download Door Drilling Template 4"



Download Door Drilling Template 5.5"



Watch installation video



Download user manual

Access and control options



Your finger is your key

Keyless access

Secure, fast, and convenient fingerprint, access code, RFID on site set-up, allows management of properties from anywhere



Hack-proof Keypad



Secure Scan-to-Open

Mobile app Control

Mobile App Control

Remotely unlock, lock, check door, track access history and unique user profile data.



Full HD Video Camera*

Secure Scan-to-Open - Unlock by unique QR code, revoke capability anytime

Real-time Monitoring and Status

Monitor open/closed door status with real-time alerts sent to your smartphone.

eKeys & eBadges

Grant one-time use or specific time duration access by issuing codes, digital eKeys or eBadges remotely via a mobile device.

Video Monitoring and Recording*

Live stream and record videos in full HD that can be stored locally

Offline Access Codes™

Grant access codes to trusted users. Codes work offline without Wi-Fi or Internet.

Doorbell with 2-Way Audio*

Doorbell with unlocking and 2-way real-time conversations

Fast Pass MIFARE RFID access

Supports up to 999 cards. (3 RFID Cards included)

Auto Locking

Never worry about forgetting to lock the door with programmable auto-locking.

Replace the key not the lock

Re-key with readily available standard 6-pin cylinder SC1 re-key kits.

Wi-Fi control

Monitoring and control from anywhere and voice assistant control.

Lockly Air Transfer programming

Duplicate user profiles from an existing Lockly smart lock to another lock in just a few clicks.

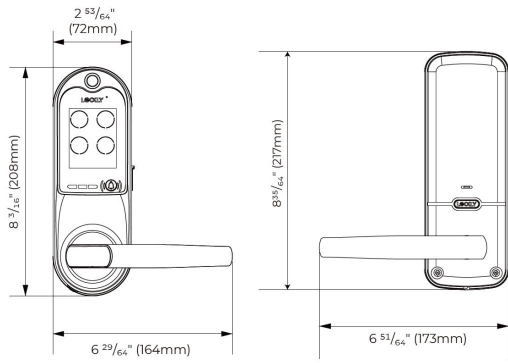

Electronic Specifications

Video Camera	Full HD Video Camera (720P/1080P)
Access Codes	Stores up to 52 PIN access codes
RFID/Fob key Access	Stores up to 65,535 ⁰⁵ MIFARE RFID/fob
Fingerprint Access	Stores up to 99 biometric fingerprints
Remotely Shareable Temporary Access	Unlimited ⁰⁵ Offline Access Codes/ eBadges ⁰⁵
Access Logs	Unlimited ⁰⁵ Accessible via LocklyPro Commercial app or LocklyOS™
Visual and audible	Exterior: LED (Red, Yellow, Green) Interior: LED (Blue) Configurable Lock/Unlock Audio Indicator Intercom (Doorbell, Microphone, Speaker)
Communication standards	BLE 4.2 , Wi-Fi 2.4GHz Advanced Encryption Standard (AES), 256-bit
Gateway communication range (networked solution)	Up to 98' (30m) BLE Up to 197' (60m) Wi-Fi Unobstructed open environment
Command Response	Responds to command from host in less than 3 seconds when linked to Lockly Wi-Fi Hub 0.2S on Fingerprint Recognition
Connectivity options	LocklyPro Commercial app, LocklyOS ALL in real-time communication
Available Signal Status	Battery Status via App Open/Close Door Status Bluetooth Connectivity Indicator Sensor LED (Red/Green)
Battery Life	AA Alkaline Batteries x 4 Up to 1 year (offline mode) up to 10 months (regular use with App & Sensor)
Operating temperature	-4°F to 151°F (-20°C to 66°C)
Operating Humidity	0 - 100% non-condensing

⁰⁵ Requires LocklyOS subscription

¹ Requires Lockly Guard Credential Manager PGA350. Up to 999 RFID/fob key can be stored without PGA350

Ordering information

1 Edition PGD679D VISION DUO	3 Cover plate included 4" C2C 5.5" C2C	6 Unifying Faceplate not included/optional PGA018s (4") PGA018 (5.5") PGA019 (4") mortise fit
2 Wi-Fi Hub PGH123 (included/optional) *Wi-Fi hub required	4 Interconnection Gear Plate included	7 RFID / Fob key 3 RFID tag keys (included) PGA803WH Tag key (10pcs/pack, optional) PGA803P Fob key (10pcs/pack, optional)
3 Finish SS Satin Nickel MB Matte Black AB Aged Bronze Custom colors available (advanced order required)	5 Sensors Built-in Wired Sensor (included/optional) Wireless Door Sensor (optional)	8 Credential Manager not included/optional PGA350

Credential Specifications

Credential technologies	RFID Card (13.56 MHz) BLE (2.4 GHz) Wi-Fi (2.4GHz) Capacitive Sensor Patented PIN Genie Keypad
Standards	ISO 14443
Maximum read range	RFID: up to 0.79" BLE: up to 98' (30m) Wi-Fi: up to 197' (60m)
RFID/Fob compatibility	MIFARE® S50
Mobile compatibility	LocklyPro Commercial app BLE 4.2 LocklyOS™

Mechanical Specifications

Handing	Field reversible
Materials	Premium Zinc Alloy chassis and escutcheon 45 mins Fire tested
Door Thickness	1-3/8" - 2 1/4" (35mm- 50mm)
Backset	Adjustable 2-3/8" or 2-3/4" (60mm or 70mm) 1" x 2 1/4" round corner faceplate
Strike	Deadbolt: 1 1/8" x 2 3/4", round corner Latchbolt: 1 3/4" x 2 1/4", round corner, Dust box included
Bore	2-1/8" (54mm) diameter Bore hole 1" (25mm) diameter latch hole
Physical Keys	SC1 Re-keying compatible, 2pcs included

Certifications /Warranty

Certification	 Intertek 5026048 UL10(C) UL 10(B) NFPA 252 CAN/ULC-S104
Warranty	Lifetime 24/7 Technical Support 2 -year Limited Mechanical & Finish 2 -year Limited Electronics



How to measure Centre to Centre Distance of an existing installation

Use the provided drilling template to measure the C2C distance of the existing door holes. Measure the distance from the center of the installed deadbolt to the center of latchbolt.

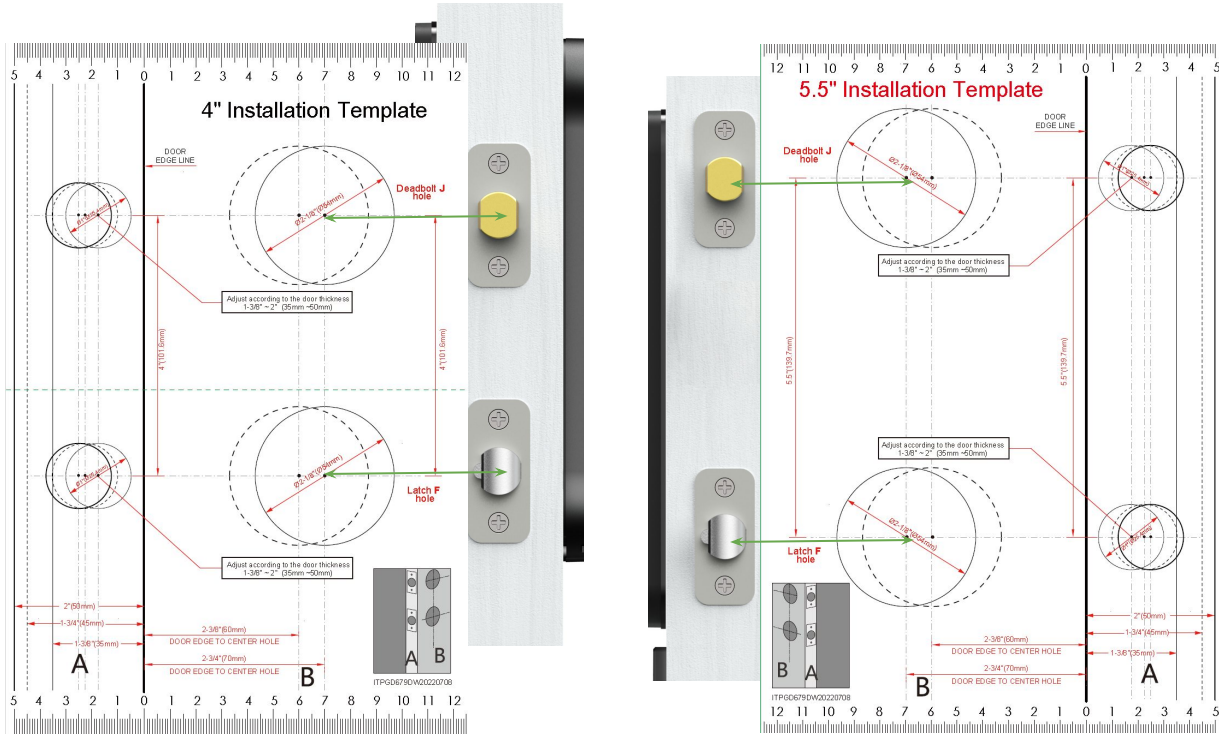

Length of the Handles

Before installation, ensure that you'll have enough space for the interior and exterior handles. Please note of the measurement of the product including the handles.

