

JMA[®]



CTP.16

**CATÁLOGO TRANSPONDER Y
MANDOS KRC**

TRANSPONDER AND KRC
REMOTES CATALOGUE

www.jma.es

A5 **JMA es Compromiso**
 JMA Konpromisoa da
 JMA is Commitment
 JMA, l'engagement
 JMA bedeutet Verpflichtung
 JMA é compromisso
 JMA jest zaangażowaniem

A 8 **Advertencia legal**
 Lege-abisua
 Legal warning
 Texte Legal
 Rechtlicher Hinweis
 Advertência legal
 Nota prawna

A 9 **Simbología**
 Sinbologia
 Symbols
 Symbologie
 Symbole
 Simbologia
 Symbolika

A10-A11 **Tecnología Transponder**
 Transponder Teknologia
 Transponder Technology
 Technologie Transpondeur
 Transponder -Technologie
 Tecnologia Transponder
 Technologii Transpondera

A14-A23 **Referencias llaves**
 Giltza referenziak
 Key range
 Références Clés
 Schlüsselreferenzen
 Referências chaves
 Kluczowe referencje

A24-A23 **ÍNDICES**
 AURKIBIDEAK
 CONTENTS
 TABLES DES MATIÈRES
 INHALT
 ÍNDICES
 INDEKSY

A24 **Índice de Marcas**
 Marken Aurkibidea
 Brand Index
 Index Marque
 Hauptmarke
 Índice de marca
 Spis marek

A25 **Índice General**
 Aurkibide Orokorra
 General Index
 Index Generale
 Gesamtverzeichnis
 Índice geral
 Ogólnego indeksu

B1-B7 **CLONACIÓN DE TRANSPONDER**
 TRANSPONDER KLONAZIOA
 TRANSPONDER CLONING
 CLONAGE DE TRANSPONDEURS
 KLONEN VON TRANSPONDERN
 CLONAGEM DE TRANSPONDER
 KLONOWANIE TRANSPONDERA



B1-B60 **Automóvil-Camioneta**
 Automobila-Kamioneta
 Car-Pick up
 Voiture-Camionnette
 Auto-Kleintransporter
 Automóvel-van
 Samochod-dostawcze

B61-B63 **Camión**
 Kamioia
 Trucks
 Camion
 Lkw
 Caminhão
 Ciężarówka

B65-B70 **Motocicleta**
 Motozikleta
 Motorcycle
 Motocyclette
 Motorrad
 Motocicleta
 Motocykl

1-21 **Tipos de llave**
 Giltza motak
 Key types
 Types de clés
 Arten von Schlüsseln
 Tipos de chaves
 Rodzaje kluczy

C25-44 **PREPROGRAMACIÓN DE TELEMANDOS**
 TELEAGINTEEN AURREPROGRAMAZIOA
 REMOTE CONTROL PRE-PROGRAMMING
 PRÉ-PROGRAMMATION DES TÉLÉCOMMANDES
 VORPROGRAMMIERUNG DER FERNBEDIENUNG
 PRÉ-PROGRAMAÇÃO DE CONTROLE REMOTO
 WSTĘPNE PROGRAMOWANIE ZDALNEGO STEROWANIA



**NUESTRO ÉXITO ESTÁ BASADO EN
EL COMPROMISO DE LAS PERSONAS**

Alejandro Altuna S.L.U es la sociedad matriz e impulsora de Altuna Group. Fabrica todo tipo de llaves para cerradura así como máquinas duplicadoras. Sus productos van destinados al mercado OEM y a la reposición, en este caso con la marca JMA.

Fundada por el Sr. Alejandro Altuna en 1942 arrancó su actividad en Mondragón. Posteriormente, la estrategia de apertura de mercados exteriores apoyada en la internacionalización y siempre basada en un enfoque innovador de los procesos industriales, ha convertido a ALTUNA GROUP en el primer productor de llaves europeo y referente mundial en este campo.

Actualmente, 15 compañías en 4 continentes trabajan conjuntamente para el desarrollo y potenciación de la fuerza de nuestra marca JMA, conocida en más de 100 países en todo el mundo.

JMA integra equipos de personas comprometidas y motivadas por un proyecto común que nos ha permitido ser el mayor fabricante de llaves de Europa.

LIDER EN TECNOLOGÍA:

Una apuesta sólida por la calidad y la innovación basada en la automatización y garantía de procesos y soportada por una vocación inversora a largo plazo.

LIDER EN CALIDAD:

Nuestra política de calidad se basa en la prevención y planificación, mejora continua, satisfacción del cliente y participación de las personas. Además de la Certificación en Calidad de acuerdo a la ISO 9001, Alejandro Altuna S.L.U. acoge Sistemas de Gestión de la Calidad homologados por las empresas líderes del sector de automoción y residencial.

**LIDER EN EL COMPROMISO
POR EL MEDIO AMBIENTE:**

En Alejandro Altuna S.L.U. las buenas prácticas medioambientales son la norma y no la excepción. Nuestro equipo forma parte de un proyecto de empresa respetuoso con el medioambiente y que colabora con el desarrollo sostenible de nuestro entorno. Alejandro Altuna S.L.U. fue el primer fabricante mundial de llaves en conseguir en 2000 el certificado ISO 14001 para su Sistema de Gestión.

LIDER EN SERVICIO:

La realidad de una empresa se demuestra en su capacidad por responder con la máxima celeridad y eficacia a las necesidades y exigencias de los clientes. Se encuentren donde se encuentren. Además, gracias a su amplia red de filiales y empresas distribuidoras repartidas por todo el mundo, le permite llegar a cualquier cliente, se cual sea su ubicación.

**OUR SUCCESS IS BASED ON
OUR PEOPLE'S COMMITMENT**

Alejandro Altuna S.L.U. is the parent company and driving force behind the Altuna Group. It manufactures all types of lock-keys and key-cutting machines. Its products are for the OEM and replacement markets, in the latter case with the JMA brand.

Set up by Alejandro Altuna in 1942, it started the production in Mondragón (Spain). Later, the strategy of opening up to foreign markets backed by globalisation and always based on an innovative attitude towards industrial processes, turned the ALTUNA GROUP into the largest producer of keys in Europe and a benchmark worldwide in the field.

Currently 15 companies in four continents work together to develop the strength of our JMA brand, well known in more than 100 countries all over the world.

This successful trail that led us to be the biggest key producer in Europe is based in our people's commitment to be:

THE LEADER IN TECHNOLOGY,

looking for the latest developments to improve the production processes together with a strong investment policy in all our plants to ensure the company's competitiveness and long-term future.

THE LEADER IN QUALITY:

Our quality policy is based on prevention and planning, continuous improvement, customer satisfaction and people participation. In addition to Quality Certification to ISO 9001, Alejandro Altuna S.L.U. operates Quality Management Systems approved by the leading companies in the automotive and residential sectors.

**THE LEADER IN THE
COMMITMENT TO THE ENVIRONMENT:**

At Alejandro Altuna S.L.U. best environmental practice is the norm and not the exception. Our team is part of a business project that respects the environment and contributes to the sustainable development of our community. Alejandro Altuna S.L.U. was the first key manufacturer in the world to achieve ISO 14001 certification for its management system in 2000.

THE LEADER IN SERVICE,

The efficiency of a company is shown in its capacity to respond with the maximum speed and effectiveness to the needs and requirements of its customers, wherever they are based. Moreover, with its extensive network of associate and distribution companies located throughout the world, the company can reach any customer, wherever based.

LA «TODO EN UNO» PARA CLONAR LLAVES DE VEHÍCULO THE ALL-IN-ONE MACHINE FOR VEHICLE KEY CLONING

1 / COPIA DE TRANSPONDER TRANSPONDER CLONING

**GRAN CAPACIDAD
DE CLONACIÓN**

GREAT CLONING CAPACITY

**NUEVA TECNOLOGÍA
LISTA PARA
ACTUALIZACIONES
de nuevos modelos transponder**

LATEST TECHNOLOGY READY
FOR FUTURE UPDATES
of new transponder models



2 / PRE-PROGRAMACIÓN DE CONTROLES REMOTOS REMOTE CONTROLS PRE-PROGRAMMING

**COPIA MÁS DE 600 REFERENCIAS
de mandos originales
EN ESTOS 3 NUEVOS MANDOS JMA**

COPY MORE THAN 600 REFERENCES
of original remote controls
WITH THESE 3 NEW JMA REMOTES

KRC100



KRC200

Escamoteable
Retractable blade



KRC300 SMART

Para apertura por
proximidad
For proximity
opening



EVO XPERT

TRANSPONDER TECHNOLOGY

**MANEJA TU
EVO XPERT
ONLINE**
MANAGE YOUR
EVO XPERT ONLINE



SIN INSTALACIÓN DE SOFTWARE
Basta con que te conectes a Internet
NO NEED TO INSTALL ANY SOFTWARE
Just connect into the Internet

TRABAJA DESDE TU MÓVIL, TABLET O PC
WORK FROM YOUR MOBILE PHONE, TABLET OR PC

TRABAJO GUÍADO PASO A PASO
STEP-BY-STEP WORK

TÚ CONTROLAS LAS ACTUALIZACIONES
Podrás realizar sólo las que precisas
TAKE CONTROL OF THE UPDATES
Just download the ones you need

LIBERTAD PARA TRABAJAR DONDE NECESITES
FREEDOM TO WORK WHEREVER YOU NEED

ALIMENTACIÓN POR BATERÍA
Trabaja sin cables

BATTERY POWERED
Wireless operation

FUNCIONA MEDIANTE APP WEB
Conéctate desde cualquier lugar y dispositivo

CONNECT TO THE WEB APP
From anywhere with any device



SACA EL MÁXIMO RENDIMIENTO A TU EVO XPERT
GET MAXIMUM PERFORMANCE FROM YOUR EVO XPERT

SAT /
CUSTOMER
SERVICE

Línea directa con nuestro departamento técnico
Direct line to our technical department

ETRAINING.JMA.ES

Plataforma online con videotutoriales y webinars
Online platform with video tutorials and webinars

ECATALOGO.JMA.ES

Busca cualquier llave que necesites duplicar
Look for any key that you need to duplicate



ESPAÑOL

Las llaves que aparecen en este catálogo son piezas JMA fabricadas por Alejandro ALTUNA S.L.U. o un subcontratista de éste. Están diseñadas para cilindros y cerraduras de los fabricantes cuyas marcas se indican en este catálogo. Conforme a las disposiciones legales vigentes relativas a la propiedad industrial, las marcas o nombres comerciales indicados en este catálogo son propiedad exclusiva de los fabricantes de cilindros y cerraduras, así como de los fabricantes de automóviles, otros constructores, distribuidores y usuarios. Dichas marcas o nombres comerciales se indican en calidad simplemente informativa con el fin de reconocer con rapidez la cerradura a la que corresponden nuestras piezas.

Este catálogo está reservado exclusivamente a profesionales de la reproducción de llaves que utilizan piezas JMA. Los datos referentes a los productos de este catálogo tienen carácter indicativo. Manteniendo siempre las características básicas, nos reservamos el derecho de realizar, sin previo aviso, modificaciones técnicas, estéticas o de otro tipo, por razones de evolución de los productos en cuestión.

Algunos modelos que están en este nuevo catálogo podrán recibirlos tanto con la marca y la referencia JMA como con otra marca del grupo ALTUNA.

ENGLISH

The keys that appear in this catalogue are JMA parts manufactured by Alejandro ALTUNA S.L.U. or one of its subcontractors. They are designed for cylinders and locks made by the manufacturers whose trademarks are indicated in this catalogue. In accordance with legal requirements relating to industrial property rights, the trademarks or trade names indicated in this catalogue are the exclusive property of the manufacturers of the cylinders and locks, as well as automobile manufacturers, other constructors, distributors and users. The aforementioned trademarks or trade names are indicated simply for information purposes so that the lock to which our parts correspond can be recognised quickly and easily. This catalogue is for the exclusive use of professional key copiers who use JMA parts. Data referring to the products in this catalogue are indicative in nature. Although the basic characteristics are maintained at all times, we reserve the right to make, without previous notice, any technical, aesthetic or other types of changes involved in the development of the products in question.

Some of the keys in this new catalogue could be received either with the JMA reference and trademark or with another trademark from the ALTUNAGroup.

DEUTSCH

Die in dem vorliegenden Katalog aufgeführten Schlüssel sind JMA-Teile, die von der Firma Alejandro ALTUNA, S.L.U., einem Zulieferanten von JMA, hergestellt werden. Sie sind für Zylinder und Schlösser derjenigen Hersteller entwickelt worden, deren Marken in diesem Katalog aufgeführt sind. In Übereinstimmung mit den geltenden gesetzlichen Vorschriften bezüglich des gewerblichen Eigentums sind die im vorliegenden Katalog aufgeführten Marken und Firmennamen ausschließliches Eigentum der Zylinder- und Schloßhersteller, sowie der Automobilhersteller und anderer Konstrukteure, Vertrieber und Benutzer. Diese Marken und Firmennamen werden nur zu Informationszwecken aufgeführt, mit dem Ziel, auf schnelle Weise zu erkennen, zu welchem Schloß unsere Teile gehören.

Dieser Katalog ist ausschließlich für Fachleute des Bereichs der Schlüsselreproduktion gedacht, die JMA-Teile verwenden.

Die Daten bezüglich der Produkte des vorliegenden Katalogs haben informativen Charakter. Bei Aufrechterhaltung der grundlegenden Eigenschaften behalten wir uns das Recht vor, aus Gründen der Entwicklung der entsprechenden Produkte und ohne Vorankündigung technische, ästhetische oder andere Änderungen vorzunehmen.

Einige Modelle des neuen Katalogs können Sie sowohl mit der Marke und der Bezeichnung JMA erhalten, als auch mit jeder anderen Marke der Gruppe ALTUNA.

EUSKERA

Katalogo honetan ageri diren giltzak Alejandro ALTUNA SA enpresak edo honek kontratatutako beste enpresa batek egindako JMA piezak dira. Katalogoan zehazten diren marken fabrikatzaileen zilindro eta sarrailetarako diseinatuta daude. Jabetza industrialari buruz indarrean dauden lege-xedapenekin bat etorri, katalogo honetan zehaztutako merkataritza-markak edo izenak zilindro eta sarraileen fabrikatzaileen nahiz ibilgailuen fabrikatzaileen eta beste eraikitzaile, bantzaile eta erabiltzaile batzuen jabetza eskusibokoak dira. Merkataritza-marka edo izen horiek zehaztasun gehiago emateko adierazten dira, gure piezak zein sarraileri dagozkion berehala ikusi ahal izateko. Katalogo hau giltzen kopiak egiteko JMA piezak erabiltzen dituzten profesionalentzako da soilik.

Katalogo honetako produktuei buruzko datuek izaera adierazgarria dute. Oinarrizko ezaugarriak gordez, produktuen bilakaeraren ondoriozko aldaketa teknikoak, estetikoak edo bestelakoak egiteko eskubidea dugu, aurretik horren berri eMAN © beharrik gabe.

Katalogo berri honetan dauden eredueta batzuk JMA marka eta erreferentziarekin nahiz ALTUNA taldeko beste marka batekin jaso ahal izango dira.

FRANÇAIS

Les ébauches de clés reportées sur ce catalogue sont des ébauches JMA fabriquées par Alejandro ALTUNA S.L.U. ou un de ses sous-traitants. Elles sont destinées aux cylindres et serrures des fabricants dont les marques sont indiquées dans ce catalogue. Conformément aux dispositions légales en vigueur relatives à la propriété industrielle, les marques ou les dénominations commerciales citées dans ce catalogue sont la propriété exclusive des fabricants de cylindres et de serrures ainsi que des constructeurs de voitures, autres constructeurs, distributeurs et utilisateurs. Ces marques ou dénominations commerciales sont indiquées à titre de simple information afin de connaître rapidement à quelle serrure nos ébauches sont destinées. Ce catalogue est exclusivement réservé aux professionnels de la reproduction de clés, utilisant des ébauches JMA. Les renseignements sur les produits de ce catalogue sont donnés à titre indicatif. Tout en gardant les caractéristiques de base, nous nous réservons le droit d'apporter, sans préavis, des modifications techniques, esthétiques ou autres, dues à l'évolution des produits en question.

Des ébauches de, cet catalogue pourront être livrées soit avec la marque et référence JMA soit avec une autre marque du groupe ALTUNA.

SIMBOLOGÍA

SYMBOLS

| NOMBRE O SÍMBOLO IZENA EDO IKURRA NAME OR SYMBOL NOM OU SYMBOLE NAME ODER SYMBOL | OBSERVACIONES OHARRAK OBSERVATIONS REMARKUES BEMERKUNGEN |
|--|--|
| | MARCA VEHÍCULO - I BILGAILU MARKA - VEHICLE BRAND - MARQUE DU VEHICULE - FAHRZEUGMARKE |
| | MODELO - MODELO - MODEL - MODELE - MODELL |
| | MODELO - MODELO - MODEL - MODELE - MODELL |
| | MODELO - MODELO - MODEL - MODELE - MODELL |
| | FABRICADO DESDE HASTA - GEROZTIK ARTE FABRIKATUA . - MANUFACTURED FROM TO - FABRIQUE D... AU... - HERGESTELLT VON BIS |
| | TP ORIGINAL - JATORRIZKO TPa - ORIGINAL TP - TP ORIGINAL - ORIGINAL - TP |
| | MODELO LLAVE - GILTZA MODELOA - KEY MODEL - MODELE CLEF - SCHLÜSSELMODELL |
| | PÁGINA CATÁLOGO - KATALOGO ORRIALDEA - CATALOGUE PAGE - PAGE CATALOGUE - KATALOGSEITE |
| TRS5000/ TRS-5000 EVO | MÁQUINA - MAKINA - MACHINE - MACHINE - MASCHINE |
| Basic | TRS 5000 |
| TPX Cloner | TRS 5000 + TPX |
| TPH Cloner | TRS 5000 + TPH |
| Programming TP | <p>Denominación comercial que JMA utiliza para los TP originales que se necesitarán a la hora de programar una llave via OBD II, con cualquier Scanner/Máquina de Diagnóstico del mercado de reposición.</p> <p>Giltza OBD II bidez ordezkapenen merkatuko Diagnosirako makinien edo eskanerren bitartez programatzeko JMAk jatorrizko TPentzat erabiltzen duen zen komertziala.</p> <p>The trading name used by JMA for the original TP that will be needed when programming a key via OBD II with any Scanner/ Diagnosis Tool on the replacement market.</p> <p>Dénomination commerciale que JMA utilise pour les TP originaux qui seront nécessaires au moment de programmer une clé via OBD II, avec n'importe quel Scanner/Machine de Diagnostique du marché du remplacement.</p> <p>Das ist die Handelsbezeichnung, die JMA für die Original-Transponder verwendet, die MAN ® für die Programmierung eines Schlüssels über OBD II mit einem Scanner/einer Diagnosemaschine des Ersatzteilmarktes benötigt.</p> |
| DEALER KEY | TELEMANDO-TELEAGINTEA-REMOTO CONTROL-TELECOM-MANDE-FERNSTEUERUNG |
| MEG | MEGAMOS ® FIJO |
| MEG/CR | MEGAMOS ® CRYPTO |
| MOTORO | MOTOROLA ® |
| PHI | PHILIPS ® FIJO |
| PHI/CR | PHILIPS ® CRYPTO |
| PHI/(EVO) | PHILIPS ® EVOLUTIVO NO COPY |
| SAAB ® | SAAB ® |
| SOK/CR | SOKYMAT ® CRYPTO |
| TARJ. | TARJETA - CARD |
| TEMIC | TEMIC ® FIJO |
| TEM/CR | TEMIC ® CRYPTO |
| TEX | TEXAS ® FIJO |

| NOMBRE O SÍMBOLO IZENA EDO IKURRA NAME OR SYMBOL NOM OU SYMBOLE NAME ODER SYMBOL | OBSERVACIONES OHARRAK OBSERVATIONS REMARKUES BEMERKUNGEN |
|--|---|
| * | <p>"La mayoría de los nuevos vehículos necesitan una preconfiguración de los transponders disponibles en el mercado antes de ser programados en los vehículos, utilizando para ello diferentes herramientas como Scanner via OBDII, portátiles, etc..."</p> <p>Estos pre-códigos, hablando por ejemplo del grupo VW, quiere decir que se deben extraer 7 bytes del CS (Component security), diferente para cada vehículo y llave, extrayendo dicho valor bien desde el Inmovilizador o bien desde la unidad de control (ECU), y programar dichos esos valores sobre el chip.</p> <p>"Ibilgailu berri gehienek merkatuan dauden transponderrak aurretik konfiguraturatu eduki behar dituzte. Horretarako, OBDII portatilaireta abarren bitartezko hainbat tresna erabiltzen dira."</p> <p>Aurre-kode horiek, VW taldekoak esaterako, CS-tik (Component security) 7 byte ateratzen dituztela esan nahi du, ibilgailu eta giltza bakoitzarentzako desberdina. Ibilgetzeko gailutik edo kontrolako unitatetik (ECU) ateratzen ditu balioak eta balio horiek txipean programatzen ditu.</p> <p>"Most new vehicles require pre-configuration of the transponders available on the market before they are programmed in the vehicles themselves. Various tools can be used to do this, such as a Scanner via OBDII, laptop, etc."</p> <p>Using the VW group as an example, these pre-codes mean that 7 bytes from the CS (Component Security) must be extracted. This is different for each vehicle and key, and the value is extracted from either the Immobiliser or from the ECU (Engine Control Unit). The value must then be programmed onto the chip.</p> <p>« La plupart des nouveaux véhicules ont besoin d'une préconfiguration des transpondeurs disponibles sur le marché avant d'être programmés dans les véhicules, en utilisant pour cela différents outils comme le Scanner via OBDII, les portables, etc. »</p> <p>Ces pré-codes, en parlant par exemple du groupe VW, cela signifie que 7 bytes du CS (Component security) doivent être extraits, différent pour chaque véhicule et chaque clé, en extrayant cette valeur ou bien depuis l'Immobilisateur ou bien depuis l'unité de contrôle (ECU), et programmer ces valeurs sur la puce.</p> <p>Bei den meisten neuen Fahrzeugen müssen die auf dem Markt verfügbaren Transponder vorprogrammiert werden, bevor sie mit verschiedenen Tools wie zum Beispiel Scanner über OBDII, Laptops usw. in die Fahrzeuge programmiert werden können."</p> <p>Im Fall von Fahrzeugen der VW-Gruppe heißt das beispielsweise, dass MAN ® mit diesen Pre-Codes 7 Bytes aus der CS (Component Security), die für jedes Fahrzeug und für jeden Schlüssel unterschiedlich ist, herausziehen muss; dieser Wert kann entweder aus der Wegfahrsperre oder aus der Steuereinheit (ECU) gezogen werden und wird dann in den Chip programmiert.</p> |
| ** | <p>Preconfigurar la cabecera adecuada en el transponder TP05 para que puedan funcionar como TP01/TP03/TP04 con la máscara que se indica en el PC Software</p> <p>Goiburur egoKIA ® aurrekonfiguratu TP05 transponderrean TP01/TP03/TP04 gisa funtziona dezaten, PC softwarean adierazitako maskararekin.</p> <p>Pre-configure the right header in the TP05 transponder so they can operate as TP01/TP03/TP04 with the mask indicated in the PC software.</p> <p>Préconfigurer la tête adéquate dans le transpondeur TP05 pour qu'il puisse fonctionner comme TP01/TP03/TP04 avec le masque indiqué dans le PC Software.</p> <p>Dann muss der entsprechende digitale Empfänger in den Transponder TP05 vorkonfiguriert werden, damit dieser als TP01/TP03/TP04 zusammen mit der Maske, die in der PC-Software angegeben ist, funktionieren kann.</p> |

TRANSPONDERS

| | | | | | | | |
|---|--|--|---|--|---|--|--|
| TP01  | TP02  | TP03  | TP04  | TP05  | TP06  | TP07  | TP08  |
| TP09  | TP10  | TP12  | TP13  | TP14  | TP16  | TP19  | TP20  |
| TP21  | TP22  | TP23  | TP24  | TP25  | TP26  | TP27  | TP29  |
| TP30  | TP31  | TP32  | TP33  | TP34  | TP35  | TP36  | TP38  |
| TPG1  | TPX1  | TPX2  | TPX4  | TPX5  | TPX5 W  | TPX6  | TPX7  |
| TPX8+  | TPH1  | TPM1  | TPAE1  | TPT1  | | | |

* 1 transponder para proceso sniff
* 1 transponder for the 'sniff' process

* El chip TPX8+ sustituye al modelo TPX8+
* The TPX8+ chip replaces the TPX8+ model

TECNOLOGÍA TRANSPONDER

TRANSPONDER TECHNOLOGY

CUADRO TRANSPONDER / TRANSPONDER TABLE

| ORIGINAL | JMA | FOR: | OBSERVACIONES-OHARRAK-REMARKS |
|----------|----------------------------|-------------------------------|---|
| TP01 | TP05 NOVA | PHILIPS® FIJO | |
| TP02 | TP02-TPX1-TPX5-TPX5 W-TPX6 | TEXAS® FIJO CRISTAL | |
| TP04 | TP05 NOVA | TEMIC® FIJO | |
| TP05 | TP05 NOVA | NOVA® FIJO | |
| TP06 | TP06-TPX2-TPX5-TPX5 W-TPX6 | TEXAS® CRYPTO CRISTAL | |
| TP07 | TP07-TPX1-TPX5-TPX5 W-TPX6 | TEXAS® FIJO CERAMICA | |
| TP08 | TP08 - TPX8+ | MEGAMOS® CRYPTO CRISTAL | |
| TP09 | TP09-TP05 | PHILIPS® CRYPTO | FOR OPEL ®-GM ® -HOLDEN ® -SUZUKI ® |
| TP10 | TP10-TPH1 | PHILIPS® CRYPTO 1º GENERACIÓN | FOR SEAT ®-VOLKSWAGEN ® |
| TP12 | TP12-TPX4-TPX5-TPX5 W | PHILIPS® CRYPTO 2º GENERACIÓN | |
| TP12CH | TP12CH-TPX4-TPX5-TPX5 W | PHILIPS® CRYPTO 2º GENERACIÓN | FOR CHRYSLER ® -DODGE ® -JEEP ® |
| TP12GM | TP12GM-TPX4-TPX5-TPX5 W | PHILIPS® CRYPTO 2º GENERACIÓN | FOR BUICK ® -CADILLAC ® -CHEVROLET ® -GMC ® -HUMMER ® |
| TP12HN | TP12HN-TPX4-TPX5-TPX5 W | PHILIPS® CRYPTO 2º GENERACIÓN | FOR ACURA ®-HONDA ® |
| TP12MT | TP12MT-TPX4-TPX5-TPX5 W | PHILIPS® CRYPTO 2º GENERACIÓN | FOR MITSUBISHI ® |
| TP12NS | TP12NS-TPX4-TPX5-TPX5 W | PHILIPS® CRYPTO 2º GENERACIÓN | FOR INFINITI ® -NISSAN ® |
| TP12RN | TP12RN-TPX4-TPX5-TPX5 W | PHILIPS® CRYPTO 2º GENERACIÓN | FOR DACIA ®-RENAULT ® |
| TP12SZ | TP12SZ-TPX4-TPX5-TPX5 W | PHILIPS® CRYPTO 2º GENERACIÓN | FOR SUZUKI ® |
| TP13 | TP13-TPH1 | PHILIPS® CRYPTO 1º GENERACIÓN | FOR NISSAN ® |
| TP14 | TP14-TPH1 | PHILIPS® CRYPTO 1º GENERACIÓN | FOR SEAT ®-VOLKSWAGEN ® |
| TP19 | TP19-TPX2-TPX5-TPX5 W-TPX6 | TEXAS® CRYPTO CERAMICA | |
| TP20 | TP20-TPX2-TPX5-TPX5 W-TPX6 | TEXAS® CRYPTO CERAMICA | FOR FORD ® -MAZDA ® |
| TP21 | TP21-TPX2-TPX5-TPX5 W-TPX6 | TEXAS® CRYPTO CERAMICA | FOR RENAULT ®-JEEP ® -CHRYSLER ® |
| TP22 | TP22 - TPX8+ | MEGAMOS® CRYPTO | FOR SEAT ® |
| TP23 | TP23 - TPX8+ | MEGAMOS® CRYPTO | FOR VOLKSWAGEN ® |
| TP24 | TP24 - TPX8+ | MEGAMOS® CRYPTO | FOR SKODA ® |
| TP25 | TP25 - TPX8+ | MEGAMOS® CRYPTO | FOR AUDI ® |
| TP26 | TP26-TPX2-TPX5-TPX5 W-TPX6 | TEXAS® CRYPTO | FOR MITSUBISHI ® |
| TP27 | TP27-TPX2-TPX5-TPX5 W-TPX6 | TEXAS® CRYPTO | FOR SUZUKI ® |
| TP28 | TP28-TPX2-TPX5-TPX5 W-TPX6 | TEXAS® CRYPTO | FOR MITSUBISHI ® |
| TP29 | TP29-TPX2-TPX5-TPX5 W-TPX6 | TEXAS® CRYPTO | FOR LEXUS ® -TOYOTA ® |
| TP30 | TP30-TPX2-TPX5-TPX5 W-TPX6 | TEXAS® CRYPTO | FOR LEXUS ® -TOYOTA ® -SCION ® |
| TP31 | TP31-TPX2-TPX5-TPX5 W-TPX6 | TEXAS® CRYPTO | FOR YAMAHA ® |
| TP32 | TP32 SOK/CR | SOKYMAT® CRYPTO | FOR HONDA ® -AUDI® A6 |
| TP33 | TP33 TEX/DST80 - TPX7 | TEXAS® CRYPTO 2º GENERACIÓN | FOR FORD ® |
| TP34 | TP34 TEX/DST80- TPG1 | TEXAS® CRYPTO 2º GENERACIÓN | FOR TOYOTA ® |
| TP35 | TP35 TEX/CR | TEXAS® CRYPTO 2º GENERACIÓN | FOR TOYOTA ® - PEUGEOT ® - CITROEN ® |
| TP36 | TP36- TPAE1 | TEXAS® CRYPTO 4º GENERACIÓN | FOR TOYOTA ® - CITROEN ® - PEUGEOT ® - SCION ® |
| TP38 | TP38 PHI/CR3 | PHILIPS® CRYPTO 3º GENERACIÓN | FOR HONDA® G |
| TPG1 | TPG1 | TEXAS® CRYPTO 2º GENERACIÓN | FOR TOYOTA® G |
| TPH1 | TPH1 | PHILIPS® CRYPTO | FOR NISSAN ® |
| TPM1 | TPM1 | MEGAMOS® CRYPTO 1º GENERACIÓN | FOR DAEWOO ® - KIA ® -CHEVROLET ® - PONTIAC ® |
| TPX1 | TPX1 | TPX1 | |
| TPX2 | TPX2 | TPX2 | |
| TPX4 | TPX4 | TPX4 | |
| TPX5 | TPX5 | TPX5 | |
| TPX5 W | TPX5 W | TPX5 W | |
| TPX6 | TPX6 | TPX6 | |
| TPX7 | TPX7 | TPX7 | |
| TPX8+ | TPX8+ | TPX8+ | |
| TPAE1 | TPAE1 | TPAE1 | FOR TOYOTA ® |



CATÁLOGO TRANSPONDER
TRANSPONDER CATALOGUE

TPG1

TOYO-15.P

| FOR: | MODELO - MODEL |
|----------------|-------------------------|
| SCION ® | IQ (CAN) |
| | TC |
| | XB (CAN) |
| | XD (CAN) |
| SUBARU ® | TREZIA |
| TOYOTA ® | AURIS |
| | CAMRY |
| | COROLLA |
| | FJ CRUISER |
| | FORTUNER |
| | HIACE |
| | HILUX |
| | INNOVA |
| | LANDCRUISER 200 |
| | LANDCRUISER PRA- DO |
| | RAV 4 |
| | VERSO |
| | VERSO-S |
| | YARIS |
| | TOYOTA ® (AUSTRALIA) |
| TOYOTA ® (USA) | 4 RUNNER |
| | AVALON |
| | CAMRY |
| | COROLLA |
| | FJ CRUISER |
| | HIGHLANDER |
| | MATRIX |
| | PRIUS C |
| | RAV 4 |
| | SEQUOIA |
| | SIENNA VAN |
| | TACOMA |
| | TUNDRA |
| VENZA | |
| YARIS | |

TOYO-19.P

| FOR: | MODELO - MODEL |
|----------|----------------|
| TOYOTA ® | AURIS (EU) |
| | AVENSIS |

TPH1

DAT-6.P2

| FOR: | MODELO - MODEL |
|----------------|----------------|
| NISSAN ® | MAXIMA |
| | MICRA |
| | MICRA VAN |
| | NX ALMERA |
| | TERRANO 3000D |
| | TERRANO II |
| | VANETTE CARGO |
| | |
| NISSAN (JAPON) | MICRA MARCH |

DAT-15.P2

| FOR: | MODELO - MODEL |
|------------------|----------------|
| NISSAN ® | ALMERA |
| | PRIMERA |
| | |
| | |
| | PATROL |
| NISSAN ® (JAPON) | X-TRAIL |

HU-DH.P3

| FOR: | MODELO - MODEL |
|---------|----------------|
| VOLVO ® | SX 12 |

HU-HAA.P1

| FOR: | MODELO - MODEL |
|-----------------------|----------------|
| FORD ® | GALAXY |
| SEAT ® | ALHAMBRA |
| | AROSA |
| | CORDOBA |
| | IBIZA |
| | INCA |
| | INCA |
| | VARIO |
| | |
| | |
| | |
| VOLKSWAGEN ® | CABRIO |
| | GOLF CABRIO |
| | LUPO |
| | POLO |
| | SHARAN |
| | TRANSPORTER |
| VOLKSWAGEN ® (USA) | EURO VAN |

HU-HAA.TLN

| FOR: | MODELO - MODEL |
|--------------|----------------|
| SEAT ® | ALHAMBRA |
| VOLKSWAGEN ® | POLO |
| | SHARAN |

HU-HAA.TLV

| FOR: | MODELO - MODEL |
|--------------|----------------|
| SEAT ® | ALHAMBRA |
| VOLKSWAGEN ® | POLO |
| | SHARAN |

NE-36.P2

| FOR: | MODELO - MODEL |
|-----------|----------------|
| PEUGEOT ® | 206 |
| | 206 CABRIO |

NE-51.P2

| FOR: | MODELO - MODEL |
|-----------|----------------|
| PEUGEOT ® | 406 |

TPM1

DAE-3D.P1

| FOR: | MODELO - MODEL |
|------------------|----------------|
| CHEVROLET ® (KR) | AVEO |
| | KALOS |
| | LACETI |
| | MATIZ |
| | NUBIRA |
| | TACUMA |

DAE-3D.P4

| FOR: | MODELO - MODEL |
|-----------|----------------|
| PONTIAC ® | G3 |

DAE-4.P1

| FOR: | MODELO - MODEL |
|------------------|----------------|
| CHEVROLET ® (KR) | LANOS |
| | LEGANZA |

DAE-6.P

| FOR: | MODELO - MODEL |
|------------------|----------------|
| CHEVROLET ® (KR) | MATIZ |
| | NUBIRA |

KI-2D.P

| FOR: | MODELO - MODEL |
|-------|----------------|
| KIA ® | CARNIVAL |
| | CLARUS |
| | PRIDE |
| | RETONA |
| | SEDONA |
| | SEPHIA |
| | SHUMA |
| | SPORTAGE |

TPT1

MAZ-10D.P

| FOR: | MODELO - MODEL |
|--------|----------------|
| FORD ® | RANGER |

MAZ-11D.P

| FOR: | MODELO - MODEL |
|---------------|----------------|
| MAZDA ® | 323 |
| | 626 |
| | MIATA |
| | MPV |
| | MX 5 |
| MAZDA ® (USA) | MPV |

MAZ-11D.P2

| FOR: | MODELO - MODEL |
|---------|----------------|
| MAZDA ® | DEMIO |

REFERENCIAS LLAVES

KEY RANGE

TPAE1

TPX1-TPX5-TPX6

| KI-7.P | |
|----------------------|-----------------------------|
| FOR: | MODELO - MODEL |
| CITROEN ® | C1 |
| PEUGEOT ® | 108 |
| SCION ® | iM |
| TOYOTA ® | AYGO CAMRY RAV 4 |
| TOYOTA ® (AUSTRALIA) | AURION |
| TOYOTA ® (USA) | CAMRY C-HR COROLLA IM |

| TOYO-15.P | |
|----------------|--|
| FOR: | MODELO - MODEL |
| TOYOTA ® | HIACE HILUX KLUGER LANDCRUISER 200 RAV 4 YARIS |
| TOYOTA ® (USA) | CAMRY COROLLA HIGHLANDER PRIUS C RAV 4 SEQUOIA SIENNA VAN TACOMA TUNDRA YARIS |

| DAI-1.P1 | |
|------------|---|
| FOR: | MODELO - MODEL |
| DAIHATSU ® | CHARADE CUORE FEROZA SIRION TERIOS YRV |
| PERODUA ® | KEMBARA |

| DAI-3.P1 | |
|------------|------------------|
| FOR: | MODELO - MODEL |
| DAIHATSU ® | CUORE MOVE |
| PERODUA ® | KELISA KENARI |

| DAT-6.P2 | |
|----------|----------------|
| FOR: | MODELO - MODEL |
| NISSAN ® | NX ALMERA |

| DAT-15.P2 | |
|---------------------|----------------|
| FOR: | MODELO - MODEL |
| INFINITI ® (NISSAN) | QX4 Q45 |

| FO-6.P | |
|--------------------|---|
| FOR: | MODELO - MODEL |
| FORD ® | COUGAR COURIER KOMBI ESCORT FIESTA GRANADA KA MONDEO ORION PUMA SCORPIO TRANSIT WINDSTAR |
| FORD ® (AUSTRALIA) | 121 |
| FORD ® (MERCOSUR) | COURIER ESCORT KA RANGER |
| FORD ® (SUDAFRIKA) | COURIER ESCORT KA |
| MAZDA ® | 121 |

| FO-15DC.P | |
|--------------|---|
| FOR: | MODELO - MODEL |
| FORD ® (USA) | CROWN VICTORIA EXCURSION EXPEDITION EXPLORER EXPLORER SPORT TRAC F-150 F-250 F-350 |

| | |
|---------------|---|
| | HEAVY TRACK LTD MUSTANG RANGER V6 TAURUS LX WINDSTAR |
| LINCOLN ® | BLACKWOOD CONTINENTAL NAVIGATOR TOWN CAR |
| MAZDA ® (USA) | B-SERIES P/U |
| MERCURY ® | GRAND MARQUIS MOUNTAINEER SABLE GS&LS |

| FO-15D.P | |
|--------------------|--|
| FOR: | MODELO - MODEL |
| FORD ® | EXPLORER |
| FORD ® (AUSTRALIA) | B-SERIES EXPLORER EXPLORER SPORT TRAC TAURUS LX/SHO |
| FORD ® (MERCOSUR) | EXPLORER F-100 |
| FORD ® (SUDAFRIKA) | EXPLORER F-100 RANGER |
| MAZDA ® | B-SERIES P/U |
| PANOZ ® | AIV ROADSTER ESPERANTE |

| FO-16.P | |
|--------------|----------------|
| FOR: | MODELO - MODEL |
| FORD ® (USA) | CONTOUR V6 |
| MERCURY ® | COUGAR |
| PANOZ ® | AIV ROADSTER |

| FO-30D.P | |
|--------------|----------------|
| FOR: | MODELO - MODEL |
| FORD ® (USA) | GT |

| FO-6.P | |
|--------------------|--|
| FOR: | MODELO - MODEL |
| FORD ® | COUGAR COURIER KOMBI FIESTA GRANADA KA MONDEO ORION PUMA SCORPIO WINDSTAR |
| FORD ® (AUSTRALIA) | 121 |
| FORD ® (MERCOSUR) | COURIER ESCORT KA RANGER COURIER ESCORT KA |
| MAZDA ® | 121 |

| HY-4.P1 | |
|-----------|--|
| FOR: | MODELO - MODEL |
| HYUNDAI ® | COUPE ELANTRA H-1 INNOVATION LANTRA SANTAMO SCOUBE |

| HY-5.P1 | |
|-----------|--|
| FOR: | MODELO - MODEL |
| HYUNDAI ® | ACCENT AMICA ATOS ATOS PRIME EXCEL PONY |

| HY-6D.P1 | |
|-----------|------------------|
| FOR: | MODELO - MODEL |
| HYUNDAI ® | SONATA SONICA |

| HY-9.P1 | |
|-----------|----------------|
| FOR: | MODELO - MODEL |
| HYUNDAI ® | STAREX |

| MIT-12.P | |
|--------------|----------------|
| FOR: | MODELO - MODEL |
| MITSUBISHI ® | ECLIPSE |

| | |
|--------------|--|
| MITSUBISHI ® | EXPRESS FOCUS GALANT MONTERO NIMBUS PAJERO SHOGUN SPACE GEAR SPACE RUNNER SPACE WAGON |
|--------------|--|

| MIT-8D.P1 | |
|--------------|--------------------------|
| FOR: | MODELO - MODEL |
| MITSUBISHI ® | COLT LANCER MIRAGE |

| MIT-8D.P2 | |
|--------------|--------------------------|
| FOR: | MODELO - MODEL |
| MITSUBISHI ® | COLT LANCER MIRAGE |

| PRO-1.P | |
|----------|----------------|
| FOR: | MODELO - MODEL |
| PROTON ® | 415 416 |

| SUZU-10.P1 | |
|------------------------|---|
| FOR: | MODELO - MODEL |
| CHEVROLET® (S.AMERICA) | TRACKER |
| SUBARU ® | JUSTY |
| SUZUKI ® | ALTO BALENO GRAND VITARA SWIFT VITARA |
| SUZUKI ® (JAPON) | ESCUDO |

| SUZU-8.P1 | |
|------------------|--|
| FOR: | MODELO - MODEL |
| SUZUKI ® | ALTO BALENO GRAND VITARA JIMNY SWIFT VITARA |
| SUZUKI ® (JAPON) | ESCUDO |

| TOYO-15.P | |
|-----------|---|
| FOR: | MODELO - MODEL |
| TOYOTA ® | 4 RUNNER AVENSIS VERSO CAMRY CELICA CENTURY COROLLA COROLLA COROLLA COROLLA VERSO |

TPX1-TPX5-TPX6

| | |
|------------------|------------------------|
| | ECHO VERSO |
| | HIACE |
| | HILUX |
| | LANDCRUISER 90 |
| | LANDCRUISER 100 |
| | PICNIC |
| | PREVIA |
| | PRIUS |
| | RAV 4 |
| | RAV 4 |
| TOYOTA @ (JAPON) | CALDINA |
| | ESTIMA |
| | GAIA |
| | IPSUM |
| | KLUGER |
| | LANDCRUISER PRA- DO |
| | MARK 2 |
| | PRONARD |
| | VEROSSA |
| TOYOTA @ (USA) | 4 RUNNER |
| | AVALON |
| | CAMRY |
| | HIGHLANDER |
| | LANDCRUISER |
| | PRIUS |
| | SEQUOIA |
| | SIENNA VAN |
| | SOLARA |

| TOYO-17.P | |
|-----------|----------------|
| FOR: | MODELO - MODEL |
| TOYOTA @ | COROLLA |

| TOYO-18.P | |
|----------------------------|-----------------|
| FOR: | MODELO - MODEL |
| LEXUS @ (TOYOTA) | ES300 |
| | LS400 |
| | LX450 |
| | LX470 |
| | SC300/400 |
| LEXUS @ (TOYOTA @) (JAPON) | CELSIOR |
| | LANDCRUISER |
| LEXUS @ (TOYOTA @) (USA) | LS400 |
| | SC300/400 |
| TOYOTA @ | CENTURY |
| | LANDCRUISER 100 |
| TOYOTA @ (JAPON) | CELSIOR |

| TOYO-19.P | |
|-----------|----------------|
| FOR: | MODELO - MODEL |
| TOYOTA @ | AVENSIS |
| | CARINA |

| TOYO-20D.P | |
|------------|----------------|
| FOR: | MODELO - MODEL |
| DAIHATSU @ | COPEN |
| PERODUA @ | KEMBARA |

| TOYOTA @ | ECHO |
|--------------------------|------------------------|
| | MR2 |
| | YARIS |
| TOYOTA @ (JAPON) | PLAZ |
| TOYOTA @ (USA) | MR2 SPIDER |
| TOYO-30.P | |
| FOR: | MODELO - MODEL |
| LEXUS @ (TOYOTA@) | ES300 |
| | GS SERIES |
| | GS300 |
| | GS400 |
| | GS430 |
| | IS200 |
| | IS300 |
| | LS200 |
| | LS400 |
| | LX470 |
| | RX300 |
| LEXUS @ (TOYOA@) (JAPON) | ALTEZZA |
| | CELSIOR |
| | GS300 |
| | GS400 |
| LEXUS @ (TOYOA@) (USA) | GS300/GS400 |
| | IS300 |
| | LS400 |
| | LS430 |
| | SC300/400 |
| TOYOTA @ | LANDCRUISER 100 |
| TOYOTA @ (JAPON) | ARISTO |
| | BREVIS |
| | CELSIOR |
| | CROWN |
| | LANDCRUISER PRA- DO |
| | ORIGIN |
| | PROGRESS NC300 |
| | WINDOM |

| TOYO-36.P | |
|-------------------|----------------|
| FOR: | MODELO - MODEL |
| LEXUS @ (TOYOTA@) | ES300 |
| | GS SERIES |
| | IS200 |
| | IS300 |
| | LS200 |
| | LS400 |

TPX2-TPX5-TPX6

| CHR-15.P | |
|------------|------------------|
| FOR: | MODELO - MODEL |
| CHRYSLER @ | 300M |
| | CIRRUS |
| | CIRRUS |
| | CIRRUS SEDAN |
| | CONCORDE |
| | LHS |
| | NEON |
| | NEW YORKER |
| | PT CRUISER |
| | SEBRING CONVERT |
| | SEBRING COUPE |
| | SEBRING SEDAN |
| | STRATUS |
| | STRATUS 2 DR. |
| | TOWN & COUNTRY |
| | VISION |
| | VOYAGER VAN |
| DODGE @ | CARAVAN |
| | DAKOTA |
| | DURANGO |
| | INTREPID |
| | NEON |
| | RAM |
| | 1500/2500/3500 |
| | STRATUS (CANADA) |
| | STRATUS COUPE |
| | STRATUS SEDAN |
| VISION | |
| EAGLE @ | VISION |
| JEEP @ | CHEROKEE |
| | CJ5 / CJ7 |
| | G.CHEROKEE |
| | LIBERTY |
| | WRANGLER |
| PLYMOUTH @ | BREEZE |
| | GRAND VOYAGER |
| | NEON |
| | PROWLER |

| CHR-19.P | |
|------------|----------------|
| FOR: | MODELO - MODEL |
| CHRYSLER @ | SEBRING COUPE |
| DODGE @ | STRATUS COUPE |

| CIT-1.P | |
|-----------|----------------|
| FOR: | MODELO - MODEL |
| CITROEN @ | C1 |
| PEUGEOT @ | 107 |
| TOYOTA @ | AYGO |

| DAE-3D.P1 | |
|------------------|----------------|
| FOR: | MODELO - MODEL |
| CHEVROLET @ (KR) | LACETTI |
| | NUBIRA SW |

| DAE-4.P1 | |
|------------------|----------------|
| FOR: | MODELO - MODEL |
| CHEVROLET @ (KR) | EPICA |
| | EPICA |
| | EVANDA |

| DAI-1.P1 | |
|------------|----------------|
| FOR: | MODELO - MODEL |
| DAIHATSU @ | BE-GO |
| | BOON |
| | COO |
| | CUORE |
| | MATERIA |
| | SIRION |
| | STORIA |
| | TERIOS |
| | TREVIS |

| DAT-15.P2 | |
|------------------|----------------|
| FOR: | MODELO - MODEL |
| NISSAN @ | ALMERA |
| | ALMERA |
| | ALMERA TINO |
| | ALTIMA |
| | ARMADA |
| | FRONTIER P/UP |
| | FRONTIER P/UP |
| | MICRA |
| | MURANO |
| | NAVARA |
| | NAVARA |
| | NOTE |
| | PATHFINDER |
| | PATROL GR |
| | PRIMERA |
| | PULSAR |
| | SENTRA |
| | X-TERRA |
| | X-TRAIL |
| | X-TRAIL |
| | X-TRAIL |
| NISSAN @ (JAPON) | X-TRAIL |
| SUBARU @ | LIBERTY |

| DAT-15.P3 | |
|-----------------------|----------------|
| FOR: | MODELO - MODEL |
| INFINITI @ (NISSAN @) | G20 |
| | I30 / I35 |
| NISSAN @ (USA) | FRONTIER |
| | PATHFINDER |
| | X-TERRA |

| DAT-15.P4 | |
|-----------------------|----------------|
| FOR: | MODELO - MODEL |
| INFINITI @ (NISSAN @) | QX4 |
| | 350 Z |
| | SENTRA |
| NISSAN @ (JAPON) | CEFIRO |
| NISSAN @ (USA) | ALTIMA |
| | MAXIMA |
| | SENTRA |
| | X-TRAIL |

| DAT-6.P2 | |
|------------------|----------------|
| FOR: | MODELO - MODEL |
| NISSAN @ | ATLEON |
| | ATLEON |
| | CAB STAR |
| | CAB STAR |
| | MICRA |
| | MICRA VAN |
| | TERRANO II |
| | VANETTE CARGO |
| NISSAN @ (JAPON) | MICRA MARCH |

| FO-15DC.P | |
|---------------|----------------|
| FOR: | MODELO - MODEL |
| FORD @ (USA) | ESCAPE |
| | FOCUS |
| | THUNDERBIRD |
| LINCOLN @ | CONTINENTAL |
| | LS |
| MAZDA @ (USA) | TRIBUTE |

| FO-15D.P | |
|--------------------|---------------------|
| FOR: | MODELO - MODEL |
| FORD @ (AUSTRALIA) | ESCAPE |
| | ESCAPE |
| | EXPLORER |
| | EXPLORER |
| | EXPLORER SPORT TRAC |
| | FOCUS |
| | TAURUS |
| | TAURUS |
| | TAURUS LX/SHO |
| | TRIBUTE |
| FORD @ (MERCOSUR) | RANGER |
| FORD @ (SUDAFRIKA) | RANGER |
| MAZDA @ | B-SERIES P/U |
| | TRIBUTE |

| FO-24.P | |
|--------------------|----------------|
| FOR: | MODELO - MODEL |
| FORD @ | FIESTA |
| | FOCUS |
| | FOCUS C-MAX |
| | GALAXY |
| | KUGA |
| | MONDEO |
| | S-MAX |
| FORD @ (AUSTRALIA) | FALCON BF |
| | FALCON FG |
| | FIESTA |
| | FOCUS |
| FORD @ (MERCOSUR) | MONDEO |
| FORD @ (SUDAFRIKA) | MONDEO |

| FO-24.TL2 | |
|-----------|----------------|
| FOR: | MODELO - MODEL |
| FORD @ | FIESTA |
| | FOCUS |
| | FOCUS C-MAX |

TPX2-TPX5-TPX6

| | |
|--|--------|
| | GALAXY |
| | MONDEO |
| | MONDEO |

FO-30D.P

| FOR: | MODELO - MODEL |
|--------------------|---------------------|
| FORD @ (MERCOSUR) | RANGER |
| FORD @ (SUDAFRIKA) | EXPLORER |
| | RANGER |
| FORD @ (USA) | CROWN VICTORIA |
| | EDGE |
| | ESCAPE |
| | E-SERIES |
| | EXPEDITION |
| | EXPLORER |
| | EXPLORER |
| | EXPLORER SPORT TRAC |
| | F-150 |
| | F-250 |
| | F-350 |
| | F-450 |
| | F-450 |
| | FIVE HUNDRED |
| | FLEX |
| | FOCUS |
| | FREESTAR |
| | FREESTYLE |
| | FUSION |
| | MUSTANG |
| | RANGER |
| | TAURUS |
| | TAURUS |
| | THUNDERBIRD |
| | WINDSTAR |

| LINCOLN @ | |
|-----------|-----------|
| | AVIATOR |
| | LS |
| | MARK LT |
| | MKS |
| | MKX |
| | MKZ |
| | NAVIGATOR |
| | TOWN CAR |
| | ZEPHYR |

| MAZDA @ | |
|---------|--------------|
| | B-SERIES P/U |
| | TRIBUTE |

| MAZDA @ (USA) | |
|---------------|--------------|
| | B-SERIES P/U |
| | TRIBUTE |

| MERCURY @ | |
|-----------|---------------|
| | GRAND MARQUIS |
| | MARAUDER |
| | MARINER |
| | MARINER |
| | MILAN |
| | MONTEGO |
| | MONTEREY |
| | MOUNTAINEER |
| | SABLE GS&LS |

| PANOZ @ | |
|---------|-----------|
| | ESPERANTE |

FO-6.P

| FOR: | MODELO - MODEL |
|--------|----------------|
| FORD @ | FIESTA |
| | FOCUS |
| | FUSION |

| | |
|--|-----------------|
| | KA |
| | MONDEO |
| | TOURNEO CONNECT |
| | TOURNEO CONNECT |
| | TRANSIT |
| | TRANSIT |
| | TRANSIT CONNECT |
| | TRANSIT CONNECT |

| FORD @ (AUSTRALIA) | |
|--------------------|-----------|
| | FALCON BA |
| | TERRITORY |

| FORD @ (MERCOSUR) | |
|-------------------|--------|
| | FOCUS |
| | KA |
| | MONDEO |

| FORD @ (SUDAFRIKA) | |
|--------------------|--------|
| | MONDEO |

| JAGUAR @ | |
|----------|--------|
| | S-TYPE |
| | XJ |
| | X-TYPE |

FO-TX.P

| FOR: | MODELO - MODEL |
|--------------------|----------------|
| FORD @ (MERCOSUR) | C-MAX |
| | ECO SPORT |
| | FIESTA |
| | FIESTA MAX |
| | FOCUS C-MAX |
| FORD @ (SUDAFRIKA) | ECO SPORT |
| | FIESTA |
| | FIESTA MAX |
| | FOCUS |
| | FOCUS C-MAX |

HU-2.P1

| FOR: | MODELO - MODEL |
|----------|----------------|
| SCANIA @ | 164 |
| | R-SERIES |

HY-6D.P1

| FOR: | MODELO - MODEL |
|-----------------|-----------------|
| HYUNDAI @ | SANTAFE |
| | SONATA |
| | SONICA |
| | TRAJET |
| | XG 25/XG30 |
| HYUNDAI @ (AUS) | GRANDEUR XG |
| HYUNDAI @ (USA) | XG 300 (CANADA) |

JAU-1.P

| FOR: | MODELO - MODEL |
|----------------|----------------|
| JAGUAR @ (USA) | XJ8 / XJR |

JAU-2.P

| FOR: | MODELO - MODEL |
|----------------|----------------|
| JAGUAR @ | S-TYPE |
| JAGUAR @ (USA) | S-TYPE |
| | XJ8 / XJR |
| | X-TYPE |
| | X-TYPE |

KAW-16.P1

| FOR: | MODELO - MODEL |
|------------|----------------|
| KAWASAKI @ | ER-6 |
| | NINJA 650 |

| | |
|--|--------------|
| | NINJA 1000 |
| | NINJA ZX-10R |
| | NINJA ZX-14R |
| | Z 1000 |
| | ZZR 1400 |

KAW-9.P1

| FOR: | MODELO - MODEL |
|------------|----------------|
| KAWASAKI @ | ER-6 |
| | NINJA ZX-10R |
| | NINJA ZX-12R |
| | NINJA ZX-14R |
| | NINJA ZX-6R |
| | Z 750S |
| | Z 1000 |
| | ZZR 1200 |
| | ZZR 1400 |

KI-2D.P

| FOR: | MODELO - MODEL |
|-------|----------------|
| KIA @ | CARENS |
| | CARNIVAL |
| | JOICE |
| | RETONA |
| | RIO |
| | RONDO |
| | SEPHIA |
| | SHUMA |
| | SPORTAGE |

KI-7.P

| FOR: | MODELO - MODEL |
|-------------|----------------|
| KIA @ (USA) | AMANTI |

KI-9.P

| FOR: | MODELO - MODEL |
|-------|----------------|
| KIA @ | AMANTI |

MAZ-11D.P

| FOR: | MODELO - MODEL |
|---------------|----------------|
| MAZDA @ (USA) | MIATA |

MAZ-11D.P2

| FOR: | MODELO - MODEL |
|-----------------|----------------|
| MAZDA @ | 2 |
| | 3 |
| | 5 |
| | 6 |
| | CX-5 |
| | CX-7 |
| | CX-9 |
| | MX 5 |
| | RX 8 |
| MAZDA @ (JAPON) | DEMIO |
| MAZDA @ (USA) | 2 |
| | 3 |
| | 5 |
| | 6 |
| | CX-5 |
| | CX-7 |
| | CX-9 |
| | RX 8 |

MIT-12.P

| FOR: | MODELO - MODEL |
|--------------------|----------------|
| MITSUBISHI @ | CHALLENGER |
| | DIAMANTE |
| | ECLIPSE |
| | GALANT |
| | L200 |
| | MONTERO |
| | MONTERO |
| | MONTERO IO |
| | MONTERO MINI |
| | MONTERO PININ |
| | MONTERO SPORT |
| | MONTERO SPORT |
| | PAJERO |
| | PAJERO |
| | PAJERO IO |
| | PAJERO MINI |
| | PAJERO PININ |
| | PAJERO SPORT |
| | PAJERO SPORT |
| | SHOGUN |
| | SHOGUN |
| | SHOGUN SPORT |
| | SPACE RUNNER |
| MITSUBISHI @ (USA) | MONTERO SPORT |

MIT-12.P2

| FOR: | MODELO - MODEL |
|--------------------|----------------|
| MITSUBISHI @ | CHALLENGER |
| | DIAMANTE |
| | L200 |
| | MONTERO |
| | MONTERO IO |
| | MONTERO MINI |
| | MONTERO PININ |
| | MONTERO SPORT |
| | NATIVA |
| | OUTLANDER |
| | PAJERO |
| | PAJERO IO |
| | PAJERO MINI |
| | PAJERO PININ |
| | PAJERO SPORT |
| | SHOGUN |
| | SHOGUN SPORT |
| | SPACE STAR |
| | SPACE WAGON |
| | TRITON |
| | TRITON |
| | VERADA |
| | VERADA |
| MITSUBISHI @ (USA) | DIAMANTE |
| | DIAMANTE |
| | MONTERO |
| | MONTERO SPORT |

MIT-18.P

| FOR: | MODELO - MODEL |
|--------------------|----------------|
| MITSUBISHI @ (USA) | ECLIPSE |
| | ECLIPSE |
| | ENDEAVOR |
| | GALANT |

| | |
|--|--------|
| | GALANT |
|--|--------|

MIT-8D.P1

| FOR: | MODELO - MODEL |
|--------------------|----------------|
| MITSUBISHI @ | LANCER |
| | LANCER EVO |
| | OUTLANDER |
| | SHOGUN PININ |
| MITSUBISHI @ (USA) | LANCER EVO |

NE-38.P4

| FOR: | MODELO - MODEL |
|-----------|----------------|
| RENAULT @ | AVANTIME |
| | LAGUNA I |
| | MEGANE I |
| | MEGANE I |
| | SCENIC I |
| | SCENIC I |

OP-10.P

| FOR: | MODELO - MODEL |
|----------|----------------|
| SUBARU @ | G3X JUSTY |
| SUZUKI @ | IGNIS |

SSA-1.P1

| FOR: | MODELO - MODEL |
|-------------|----------------|
| SSANGYONG @ | ACTYON |
| | KYRON |
| | REXTON |

SUB-2.P

| FOR: | MODELO - MODEL |
|----------------|----------------|
| SUBARU @ | B9 TRIBECA |
| | EXIGA |
| | FORESTER |
| | FORESTER |
| | IMPREZA |
| | IMPREZA |
| | LEGACY |
| | LEGACY |
| | LIBERTY |
| | OUTBACK |
| | OUTBACK |
| | OUTBACK |
| | WRX |
| SUBARU @ (USA) | FORESTER |
| | IMPREZA |
| | IMPREZA WRX |
| | LEGACY |
| | OUTBACK |

SUB-3.P2

| FOR: | MODELO - MODEL |
|----------|----------------|
| SUBARU @ | B9 TRIBECA |
| | BAJA |
| | FORESTER |
| | FORESTER |
| | IMPREZA |
| | IMPREZA |
| | LEGACY |
| | LIBERTY |
| | OUTBACK |

TPX2-TPX5-TPX6

| | |
|---------------|--------------|
| | WRX |
| SUBARU® (AUS) | FORESTER |
| | IMPREZA |
| | LIBERTY |
| | OUTBACK |
| SUBARU®(USA) | FORESTER |
| | IMPREZA |
| | LEGACY |
| | OUTBACK / GT |
| | TRIBECA B9 |

SUZU-8.P1

| FOR: | MODELO - MODEL |
|-----------------|-------------------|
| SUZUKI® | IGNIS |
| | JIMNY |
| SUZUKI® (INDIA) | MARUTI VERSA |
| | MARUTI WAGON R |
| | MARUTI ZEN ESTILO |

SUZU-8I.P1

| FOR: | MODELO - MODEL |
|----------------|----------------|
| SUZUKI® | ALTO |
| SUZUKI®(INDIA) | MARUTI ALTO |

SUZU-10.P1

| FOR: | MODELO - MODEL |
|--------|----------------|
| ISUZU® | BIG HORN |
| | TROOPER |

SUZU-14.P2

| FOR: | MODELO - MODEL |
|---------|----------------|
| SUZUKI® | IGNIS |
| | JIMNY |

SUZU-15D.P

| FOR: | MODELO - MODEL |
|---------|--------------------|
| SUZUKI® | GSF BANDIT |
| | GSR 600 |
| | GSX 1300 HAYA-BUSA |
| | GSX-R1000 |
| | GSX-R600 |
| | GSX-R750 |
| | V-STROM |

SUZU-17D.P2

| FOR: | MODELO - MODEL |
|-----------------|----------------|
| SUZUKI® (INDIA) | MARUTI ESTEEM |
| | MARUTI OMNI |

SUZU-17.P2

| FOR: | MODELO - MODEL |
|---------|----------------|
| SUZUKI® | SUZU-17.P2 |

TOYO-15.P

| FOR: | MODELO - MODEL |
|----------|----------------|
| PONTIAC® | VIBE |
| SCION® | TC |
| | XA |
| | XB |
| | XD |
| TOYOTA® | ALPHARD |
| | AURIS |
| | AVANZA |
| | AVENSIS |

| | |
|--------|-------------------|
| | AVENSIS VERSO |
| | CAMRY |
| | COROLLA |
| | FJ CRUISER |
| | FORTUNER |
| | HIACE |
| | HILUX |
| | INNOVA KIJANG |
| | IQ |
| | LANDCRUISER 100 |
| | LANDCRUISER 120 |
| | LANDCRUISER PRADO |
| | PICNIC |
| | PREVIA |
| | RAV 4 |
| | REIZ |
| | T.U.V. |
| | TARAGO |
| | URBAN CRUISER |
| | VIOS |
| WISH | |
| AURION | |

| | |
|---------------------|--|
| TOYOTA® (AUSTRALIA) | |
|---------------------|--|

| | |
|-------------------|--|
| TOYOTA® (JAPON) | |
| ALPHARD | |
| Bb | |
| COROLLA FIELDER | |
| COROLLA RUNX | |
| COROLLA SPACIO | |
| CROWN | |
| DYNA | |
| ESTIMA | |
| FUN CARGO | |
| IPSUM | |
| ISIS | |
| IST | |
| KLUGER | |
| LANDCRUISER PRADO | |
| MAJESTA | |
| MARK X | |
| NOAH | |
| OPEN DECK | |
| PLAZ | |
| RAUM | |
| RAV 4 | |
| REGIUSACE | |
| SIENTA | |
| TOYOACE | |
| VANGUARD | |
| VITZ | |
| VOXY | |
| WISH | |
| 4 RUNNER | |
| AVALON | |
| CAMRY | |
| COROLLA | |
| FJ CRUISER | |
| HIACE | |
| HIGHLANDER | |
| HILUX | |
| LANDCRUISER | |

| | |
|---------------|--|
| TOYOTA® (USA) | |
|---------------|--|

| | |
|--|------------|
| | MATRIX |
| | PRIUS |
| | RAV 4 |
| | SEQUOIA |
| | SIENNA VAN |
| | SOLARA |
| | TACOMA |
| | TUNDRA |
| | VENZA |
| | YARIS |

TOYO-15.P2

| FOR: | MODELO - MODEL |
|---------|----------------|
| SUZUKI® | LIANA |
| | LIANA |
| | SWIFT |

TOYO-19.P

| FOR: | MODELO - MODEL |
|---------------------|----------------|
| DAIHATSU® | CHARADE |
| TOYOTA® | AURIS (EU) |
| | AVENSIS |
| | AVENSIS |
| | COROLLA |
| | COROLLA |
| | YARIS |
| | COROLLA |
| TOYOTA® (SUDAFRIKA) | COROLLA |

TOYO-20D.P

| FOR: | MODELO - MODEL |
|----------|----------------|
| PERODUA® | MYVI |
| | NAUTICA |
| | VIVA |

TOYO-30.P

| FOR: | MODELO - MODEL |
|-----------------|-----------------|
| LEXUS® (TOYOTA) | ES330 |
| | GS300 |
| | GX460 |
| | GX470 |
| | LS430 |
| | LX470 |
| | RX330 |
| | RX350 |
| | RX400H |
| | RX450H |
| | LANDCRUISER 100 |

| | |
|---------------------|--|
| TOYOTA® (AUSTRALIA) | |
|---------------------|--|

TOYO-36.P

| FOR: | MODELO - MODEL |
|----------------|----------------|
| LEXUS®(TOYOTA) | ES330 |
| | GX470 |
| | LS430 |
| | LX470 |

| | |
|-----------------------|--------|
| | RX330 |
| | RX350 |
| | RX400H |
| | RX450H |
| | SC430 |
| LEXUS® (TOYOTA) (USA) | ES330 |
| | GS470 |
| | LS430 |
| | SC430 |

YAMA-26D.P2

| FOR: | MODELO - MODEL |
|---------------------|--------------------|
| YAMAHA® | BT 1100 BULLDOG |
| | FJ-09 |
| | FJR 1300 |
| | FZ-07 |
| | FZ-09 |
| | FZ1 |
| | FZ6 |
| | FZ8 |
| | FZS 1000 FAZER |
| | MAJESTY 400 |
| | MT-01 |
| | MT-03 |
| | MT-07 |
| | MT-09 |
| | MT-09 TRACER |
| | TDM 600 |
| | TDM 900 |
| | T-MAX 500 |
| | XJR 1300 |
| | X-MAX 250 |
| | XP 500 |
| | XT 660R |
| | XT 660Z TENERE |
| | XT 1200Z S.TENERE |
| | XTR |
| | XTX |
| | XVS 650A DRAG STAR |
| XVS 1100A DRAG STAR | |
| YP 400 | |
| YVS A DRAG STAR | |
| YZF R1 | |
| YZF R6 | |
| ZTR | |

ZA-9.P

| FOR: | MODELO - MODEL |
|---------|----------------|
| YAMAHA® | X-MAX 125 |

ZA-11.P

| FOR: | MODELO - MODEL |
|---------|----------------|
| YAMAHA® | X-MAX 125 |

TPX4-TPX5-TPX5W

BM-5.P4

| FOR: | MODELO - MODEL |
|-----------|----------------|
| BMW®(USA) | SERIE : 1 |
| | SERIE : 3 |
| | SERIE : 3 |
| | SERIE : 7 |
| | SERIE : 7 |
| | SERIE : 8 |
| | X3 |
| Z 4 | |

BM-6.P

| FOR: | MODELO - MODEL |
|-------------------|-------------------|
| LAND-RANGE ROVER® | RANGE ROVER |
| | RANGE ROVER VOGUE |

BM-6.P6

| FOR: | MODELO - MODEL |
|------------------------|------------------|
| BMW® | SERIE : 7 |
| BMW® (USA) | M5 & M6 SEDAN |
| | SERIE : 1 W/PROX |
| | SERIE : 3 |
| | SERIE : 3 W/PROX |
| | SERIE : 5 |
| | SERIE : 5 |
| | SERIE : 6 |
| | SERIE : 6 |
| | SERIE : 6 |
| | SERIE : M3 & M5 |
| | X 3 |
| | X 3, X 5, X 6 |
| | X 5 |
| X 5 | |
| Z 3 | |
| Z 4 | |
| LAND-RANGE ROVER®(USA) | RANGE ROVER |

BM-6RKE

| FOR: | MODELO - MODEL | |
|------------|----------------|-------------------------|
| BMW® | SERIE : 1 | |
| | SERIE : 3 | |
| | SERIE : 5 | |
| | SERIE : 6 | |
| | X 1 | |
| | X 5 | |
| | X 6 | |
| | Z 4 | |
| | BMW®(USA) | SERIE : 1 (128i - 135i) |
| | | SERIE : 7 |
| | | X 5 W/PROX |
| | X 6 W/PROX | |
| Z 4 W/PROX | | |

REFERENCIAS LLAVES

KEY RANGE

TPX4-TPX5-TPX5W

BM-6RKE1

| FOR: | MODELO - MODEL |
|------------|------------------------|
| BMW® (USA) | SERIE : 7 SERIE : 7 |

BM-7.P

| FOR: | MODELO - MODEL |
|------|---|
| BMW® | C 600 SPORT C 650 GT F 650 F 800 G 650 K 1200 K 1300 K 1600 R 1200 RT |

CHR-15.P

| FOR: | MODELO - MODEL |
|-------------------|---|
| CHRYSLER® | 200 300/300C ASPEN PACIFICA PT CRUISER SEBRING CONVERT SEBRING SEDAN TOWN & COUNTRY VOYAGER VAN |
| DODGE® | AVENGER CALIBER CARAVAN CHARGER DAKOTA DURANGO MAGNUM NITRO RAM 1500 SPORT RAM 2500/3500 SPORT |
| JEEP® | CHEROKEE CJ5 / CJ7 COMANCHE COMMANDER COMPASS G.CHEROKEE LIBERTY PATRIOT WRANGLER |
| MITSUBISHI® | RAIDER |
| MITSUBISHI® (USA) | RAIDER |
| STERLING® | BULLET |

CHR-15.P1

| FOR: | MODELO - MODEL |
|-----------|--|
| CHRYSLER® | 300/300C TOWN & COUNTRY VOYAGER VAN |
| DODGE® | CARAVAN CHALLENGER CHARGER DART DURANGO JOURNEY MAGNUM |

| | |
|-------------------|-------------------------------------|
| JEEP® | RAM 1500 COMMANDER G.CHEROKEE |
| VOLKSWAGEN® | ROUTAN |
| VOLKSWAGEN® (USA) | ROUTAN |

CIT-1.P

| FOR: | MODELO - MODEL |
|----------------|--|
| CITROEN® | BERLINGO C2 C3 C3 PICASSO C3 PLURIEL C4 C5 C6 DS3 DS4 |
| NISSAN® | NV 400 |
| OPEL-VAUXHALL® | MOVANO |
| PEUGEOT® | 407 508 1007 PARTNER RANCH |
| RENAULT® | CLIO III FLUENCE KANGOO MASTER MODUS TWINGO |

DAE-3D.P4

| FOR: | MODELO - MODEL |
|---------------|----------------|
| SUZUKI® (USA) | RENO |

DAC-4D.P

| FOR: | MODELO - MODEL |
|----------------|-------------------------------------|
| RENAULT® | TWIZY |
| RENAULT DACIA® | DOKKER LOGGY LOGAN SANDERO |

DAE-4.P1

| FOR: | MODELO - MODEL |
|-----------------|----------------|
| CHEVROLET® (KR) | CAPTIVA |
| HOLDEN® | CAPTIVA |
| OPEL-VAUXHALL® | ANTARA |

DAE-4D.P2

| FOR: | MODELO - MODEL |
|------------------|----------------|
| CHEVROLET® (USA) | CAPTIVA SPORT |
| DAEWOO® (USA) | LEGANZA |
| SATURN® | VUE |
| SUZUKI® (USA) | VERONA |

DAT-15.P2

| FOR: | MODELO - MODEL |
|--------------------|---|
| INFINITI® (NISSAN) | FX35 / FX45 |
| NISSAN® | ALMERA ALMERA TINO ALTIMA CAB STAR |

| | |
|----------|---|
| RENAULT® | CUBE FRONTIER P/UP JUKE KING CAB LIVINA MICRA NAVARA NOTE NP 300 NT500 NV 200 PATHFINDER PATROL GR PRIMERA QASHQAI QASHQAI QUEST TIIDA X-TERRA X-TRAIL MAXITY |
|----------|---|

DAT-15.P3

| FOR: | MODELO - MODEL |
|--------------------|--|
| INFINITI® (NISSAN) | FX35 / FX45 G35 M45 Q45 QX56 |
| NISSAN® (USA) | 350 Z ALTIMA ARMADA CUBE FRONTIER JUKE LIVINA MAXIMA MICRA MURANO NV 1500/2500/3500 NV 200 PATHFINDER QUEST ROGUE SENTRA TIIDA TITAN VERSA X-TERRA EQUATOR |
| SUZUKI® | EQUATOR |
| SUZUKI® (USA) | EQUATOR |

DAT-6.P2

| FOR: | MODELO - MODEL |
|---------|----------------|
| NISSAN® | ATLEON |

FI-11.P5

| FOR: | MODELO - MODEL |
|--------|---------------------------------------|
| IVECO® | 35 C11 DAILY EUROSTAR S 2000 |

FI-16.P

| FOR: | MODELO - MODEL |
|-------------------|--|
| ABARTH® | 500 GRANDE PUNTO PUNTO PUNTO EVO |
| ALFA ROMEO® | 156 156 SPORT WAGON 166 GIULIETTA MITO |
| CHRYSLER® | YPSILON JUMPER NEMO RELAY |
| DODGE® | PROMASTER |
| FIAT® | 500 500L BRAVO DOBLO DUCATO FIORINO GRAND SIENA GRANDE PUNTO IDEA PANDA PANDA PUNTO PUNTO EVO QUBO VIAGGIO |
| FIAT® (S.AMERICA) | PALIO (BRASIL) |
| FIAT® (USA) | 500 500 CABRIO |
| FORD® | KA |
| IVECO® | DAILY EUROCARGO STRALIS |
| LANCIA® | DELTA MUSA YPSILON |
| OPEL-VAUXHALL® | COMBO |
| PEUGEOT® | BIPPER BOXER |

FO-24.P

| FOR: | MODELO - MODEL |
|-------------------|----------------------------------|
| LAND-RANGE ROVER® | DISCOVERY 3 RANGE ROVER SPORT |

GM-27.P

| FOR: | MODELO - MODEL |
|------------------------|----------------|
| CHEVROLET® (S.AMERICA) | S-10 |

GM-37.P

| FOR: | MODELO - MODEL |
|------------------|---|
| BUICK® | ENCLAVE LUCERNE |
| CADILLAC® | CTS DTS ESCALADE SRX STS XLR |
| CHEVROLET® (USA) | AVALANCHE COBALT EQUINOX EXPRESS HHR IMPALA MALIBU MONTECARLO SILVERADO SUBURBAN TAHOE TRAILBLAZER TRAVERSE |
| GMC® | ACADIA DENALI ENVOY SAVANA SIERRA YUKON |
| HUMMER® | H2 H2 SUT |
| PONTIAC® | G5 G6 PURSUIT SOLSTICE TORRENT |
| SATURN® | AURA OUTLOOK SKY |
| SUZUKI® (USA) | XL7 |

GM-49D.P

| FOR: | MODELO - MODEL |
|------------------|----------------|
| CHEVROLET® (USA) | CAPRICE (PPV) |
| HOLDEN® | COMMODORE VE |

HOND-21.P

| FOR: | MODELO - MODEL |
|-----------------------|-----------------|
| ACURA® (HONDA®) (USA) | RL TL TSX |

TPX4-TPX5-TPX5W

| | |
|-------------------|-----------------|
| HONDA® | GOLD WING |
| HOND-24.P1 | |
| FOR: | MODELO - MODEL |
| HONDA® | BLACK SPIRIT |
| | CBR 600F |
| | CBR 600RR |
| | CBR 900 |
| | CBR 1000 |
| | CBR 1100F |
| | CBR 1100XX |
| | CROSSRUNNER |
| | CROSSTOURER |
| | CTX 700 |
| | CTX1300 |
| | HORNET |
| | INTEGRA |
| | NC 700 S |
| | NC 700 X |
| | NC 750 |
| | NT 650V |
| | NT 700V |
| | NX 650V |
| | RUNE |
| | SHADOW 750 |
| | SILVER WING |
| | ST1300 PAN-EUR. |
| | SW-T400 |
| | SW-T600 |
| | VARADERO |
| | VFR 800 |
| | VFR1200 |
| | VT 750 C4 |
| | VT1300CX |
| | VTX 1800C |
| | X - ELEVEN |

| | |
|-----------------------|----------------|
| HOND-31.P | |
| FOR: | MODELO - MODEL |
| ACURA® (HONDA®) (USA) | CSX (CANADA) |
| | MDX |
| | RDX |
| | TL |
| | TSX |
| | ZDX |

| | |
|--------|-------------|
| HONDA® | ACCORD |
| | ACCORD |
| | AMAZE |
| | BRIQ |
| | CITY |
| | CIVIC |
| | CR-V |
| | CR-Z |
| | ELYSION (J) |
| | INSIGHT |
| | JAZZ |
| | STEPWGN |
| | STREAM |

| | |
|--------------------|-----------|
| HONDA® (AUSTRALIA) | CIVIC |
| | MDX |
| HONDA® (USA) | ACCORD |
| | CIVIC |
| | CROSSTOUR |

| | |
|--|-----------|
| | CR-V |
| | CR-Z |
| | ELEMENT |
| | FIT |
| | INSIGHT |
| | ODYSSEY |
| | PILOT |
| | RIDGELINE |
| | S 2000 |

| | |
|-------------------|----------------|
| HOND-53.P1 | |
| FOR: | MODELO - MODEL |
| HONDA® | VARADERO |

| | |
|-------------------|----------------|
| HOND-54.P1 | |
| FOR: | MODELO - MODEL |
| HONDA® | GOLD WING |
| | SILVER WING |

| | |
|------------------|----------------|
| HOND-55.P | |
| FOR: | MODELO - MODEL |
| HONDA® | AFRICAN TWIN |
| | CB 500 |
| | CB 650 |
| | CBF 600 |
| | CBR 650 |
| | CBR 1000 |
| | CROSSRUNNER |
| | CROSSTOURER |
| | INTEGRA |
| | NC 750 |

| | |
|------------------|----------------|
| HOND-56.P | |
| FOR: | MODELO - MODEL |
| HONDA® | TORNADO XR250 |

| | |
|-----------------|----------------|
| HU-DH.P3 | |
| FOR: | MODELO - MODEL |
| MITSUBISHI® | COLT |

| | |
|-----------------|----------------|
| HU-HAA.P | |
| FOR: | MODELO - MODEL |
| AUDI® | A8 |
| | Q7 |

| | |
|------------------|----------------|
| HU-HAA.P1 | |
| FOR: | MODELO - MODEL |
| PORSCHE® | CAYENNE |
| | CAYMAN |
| VOLKSWAGEN® | TOUAREG |

| | |
|-------------------|----------------|
| HU-HAA.TLN | |
| FOR: | MODELO - MODEL |
| AUDI® | A8 |
| | Q7 |

| | |
|-----------------|----------------|
| HU-HCA.P | |
| FOR: | MODELO - MODEL |
| CITROEN® | C4 PICASSO |
| | C5 |
| | C8 |
| | CACTUS |

| | |
|----------|----------|
| | C-ELYSEE |
| | DISPATCH |
| | JUMPY |
| FIAT® | SCUDO |
| | ULYSSE |
| LANCIA® | PHEDRA |
| PEUGEOT® | 207 |
| | 208 |
| | 301 |
| | 307 |
| | 308 |
| | 807 |
| | 2008 |
| | 3008 |
| | 408 |
| | 5008 |
| | EXPERT |
| | RCZ |
| TOYOTA® | PROACE |

| | |
|----------------|----------------|
| HY-4.P1 | |
| FOR: | MODELO - MODEL |
| HYUNDAI® | ACCENT |
| | AVANTE |
| | COUPE |
| | ELANTRA |
| | EXCEL |
| | GETZ |
| | H-1 |
| | LANTRA |
| | LAVITA |
| | MATRIX |
| | SANTAFE |
| | TERRACAN |
| | TIBURON |
| | TUCSON |
| | VERNA |
| KIA® | MORNING |
| | PICANTO |
| | SPORTAGE |

| | |
|----------------|----------------|
| HY-5.P1 | |
| FOR: | MODELO - MODEL |
| HYUNDAI® | AMICA |
| | ATOS PRIME |

| | |
|-----------------|------------------|
| HY-6D.P1 | |
| FOR: | MODELO - MODEL |
| HYUNDAI® | TRAJET |
| KIA® | SORENTO |
| KIA® (USA) | SORENTO (CANADA) |

| | |
|------------------|-----------------|
| HY-11D.P1 | |
| FOR: | MODELO - MODEL |
| HYUNDAI® | ELANTRA |
| | GENESIS COUPE |
| | ILOAD |
| | IMAX |
| | SANTAFE |
| | SONATA |
| | TUCSON |
| | VERACRUZ |
| HYUNDAI® (USA) | ELANTRA (CAN) |
| | ENTOURAGE (CAN) |

| | |
|------------|------------------|
| | GENESIS COUPE |
| | SANTAFE (CANADA) |
| | TUCSON (CANADA) |
| KIA® | MAGENTIS |
| | RONDO |
| | SOUL |
| | SPORTAGE |
| KIA® (USA) | FORTE (CANADA) |
| | MAGENTIS (CAN) |
| | OPTIMA (CANADA) |
| | SEDONA (CANADA) |
| | SEDONA (CANADA) |

| | |
|-----------------|------------------|
| HY-11.P1 | |
| FOR: | MODELO - MODEL |
| HYUNDAI® | AVANTE |
| | ENTOURAGE |
| | H-1 |
| | H-1 BUS |
| | I10 |
| | STAREX |
| HYUNDAI® (USA) | ACCENT (CANADA) |
| | ELANTRA (CAN) |
| | SANTAFE (CANADA) |
| | TIBURON (CANADA) |
| | TUCSON (CANADA) |
| | VERACRUZ (CAN) |
| KIA® | CARENS |
| | CARNIVAL |
| | OPTIMA |
| | SEDONA |

| | |
|-----------------|----------------|
| HY-11RKE | |
| FOR: | MODELO - MODEL |
| HYUNDAI® | SANTAFE |
| | SONATA |

| | |
|-----------------|----------------|
| HY-12.P1 | |
| FOR: | MODELO - MODEL |
| KIA® | RIO |
| KIA® (USA) | RIO (CANADA) |

| | |
|----------------|---------------------|
| HY-18.P | |
| FOR: | MODELO - MODEL |
| HYUNDAI® | ACCENT |
| | AVANTE |
| | AZERA |
| | ELANTRA NEOS |
| | GENESIS |
| | GRANDEUR |
| | I20 |
| | I30 |
| | I45 |
| | IX20 |
| | IX35 |
| | LANTRA |
| | SOLARIS |
| | SONATA |
| | TUCSON |
| | VERNA |
| HYUNDAI® (AUS) | I40 |
| | AZERA |
| | ELANTRA TOUR. (CAN) |

| | |
|------------|----------------------|
| | GENESIS 4 w/ PROX DR |
| | SONATA (CAN) |
| | TUCSON (CANADA) |
| KIA® | BORREGO |
| | CEE'D |
| | CEE'D SW |
| | MAGENTIS |
| | OPIRUS |
| | OPTIMA |
| | RIO |
| | SPORTAGE |
| KIA® (USA) | BORREGO |
| | MAGENTIS (CAN) |
| | OPTIMA (CANADA) |
| | RIO (CANADA) |
| | RONDO (CANADA) |
| | SPORTAGE (CANADA) |

| | |
|-----------------|-----------------|
| HY-18RKE | |
| FOR: | MODELO - MODEL |
| HYUNDAI® (USA) | ACCENT (CANADA) |
| | SONATA w/PROX |
| KIA® | CEE'D |
| | SORENTO |

| | |
|-----------------|----------------|
| HY-19.P1 | |
| FOR: | MODELO - MODEL |
| HYUNDAI® | SANTAFE |
| HYUNDAI® (AUS) | SANTAFE |

| | |
|------------------|----------------|
| HY-19D.P1 | |
| FOR: | MODELO - MODEL |
| HYUNDAI® (AUS) | ACCENT |
| | VELOSTER |

| | |
|----------------|----------------|
| HY-20P1 | |
| FOR: | MODELO - MODEL |
| HYUNDAI® | SOLARIS |

| | |
|-----------------|----------------|
| HY-20.P1 | |
| FOR: | MODELO - MODEL |
| KIA® | RIO |

| | |
|------------------|----------------|
| ISU-3D.P1 | |
| FOR: | MODELO - MODEL |
| HOLDEN® | COLORADO |
| ISUZU® | D-MAX |

| | |
|-----------------|-----------------|
| ISU-5.P3 | |
| FOR: | MODELO - MODEL |
| ISUZU® | ELF |
| | FFR 500/600/700 |
| | FRD 500 |
| | FSD 700/850 |
| | F-SERIES |
| | FSR 700/850 |
| | FSS 550 |
| | FTR 900 |
| | FTS 800 |
| | FVB |
| | FVL 1400 |

TPX4-TPX5-TPX5W

| |
|---------------------|
| FVM 1400 |
| FVR 1000 |
| FFV 1400 |
| FPZ 1400 |
| NLR 200 |
| NLS 200 |
| NNR 200 |
| NPR 200/250/275/300 |
| NPS 250/300 |
| NQR 450 |
| N-SERIES |

| |
|---------------------|
| KI-2D.P |
| FOR: MODELO - MODEL |
| KIA® CARENS |
| CARNIVAL |
| MAGENTIS |
| MENTOR |
| OPTIMA |
| SEDONA |
| SEPHIA |

| |
|---------------------|
| KI-2.P |
| FOR: MODELO - MODEL |
| KIA® CERATO |

| |
|--------------------------------|
| KI-7.P |
| FOR: MODELO - MODEL |
| KIA® RONDO |
| MITSUBISHI® MAGNA |
| MITSUBISHI® (AUSTRALIA) VERADA |

| |
|---------------------|
| KI-9.P |
| FOR: MODELO - MODEL |
| KIA® AMANTI |
| CEE'D |
| CEE'D SW |
| OPIRUS |
| PICANTO |
| RONDO |
| SORENTO |
| KIA®(USA) AMANTI |
| SORENTO (CANADA) |

| |
|---------------------|
| ME-7.P1 |
| FOR: MODELO - MODEL |
| DODGE® SPRINTER |

| |
|---------------------|
| MIT-12.P |
| FOR: MODELO - MODEL |
| MITSUBISHI® L200 |
| MONTERO |
| MONTERO SPORT |
| NATIVA |
| PAJERO |

| |
|---------------------|
| MIT-12.P2 |
| FOR: MODELO - MODEL |
| MITSUBISHI® L200 |
| MIRAGE |
| MONTERO |

| |
|---------------------------|
| PAJERO |
| TRITON |
| MIT-18.P |
| FOR: MODELO - MODEL |
| MITSUBISHI® ENDEAVOR |
| MITSUBISHI® (USA) ECLIPSE |
| GALANT |

| |
|----------------------|
| MIT-8DP1 |
| FOR: MODELO - MODEL |
| CITROEN® C4 AIRCROSS |
| MITSUBISHI® COLT |
| ENDEAVOR |
| OUTLANDER SPORT |

| |
|---------------------------|
| MIT-8D.P2 |
| FOR: MODELO - MODEL |
| CITROEN® C-CROSSER |
| C-ZERO |
| MITSUBISHI® 380 |
| ASX |
| ECLIPSE |
| GALANT |
| GRANDIS |
| I-MIEV |
| LANCER |
| OUTLANDER |
| MITSUBISHI® (USA) ECLIPSE |
| ENDEAVOR |
| GALANT |
| LANCER |
| OUTLANDER |
| OUTLANDER SPORT |
| PEUGEOT® 4007 |
| 4008 |
| ION |

| |
|------------------------|
| NE-36.P2 |
| FOR: MODELO - MODEL |
| PEUGEOT® 106 |
| 206 |
| 206 CABRIO |
| 206 PLUS |
| RENAULT® CLIO II FASE2 |
| MASTER |
| TRAFIC |
| RENAULT DACIA® SYMBOL |

| |
|------------------------|
| NE-38.P4 |
| FOR: MODELO - MODEL |
| NISSAN® INTERSTAR |
| PRIMASTAR |
| OPEL-VAUXHALL® MOVANO |
| VIVARO |
| RENAULT® CLIO II FASE2 |
| MASTER |
| PREMIUM DXI |
| THALIA |
| TRAFIC |

| |
|---------------------|
| NE-51.P2 |
| FOR: MODELO - MODEL |

| |
|--------------|
| PEUGEOT® 406 |
| 607 |

| |
|------------------------------------|
| NE-52.P2 |
| FOR: MODELO - MODEL |
| LAND-RANGE ROVER® FREELANDER |
| LAND-RANGE ROVER® (USA) FREELANDER |

| |
|----------------------|
| OP-11.P1 |
| FOR: MODELO - MODEL |
| CHEVROLET® (KR) AVEO |
| CRUZE |
| MALIBU |
| ORLANDO |
| TRAX |
| VOLT |
| AGILE |
| ONIX |
| PRISMA |
| TRACKER |
| HOLDEN® ASTRA |
| BARINA |
| COMMODORE VF |
| VECTRA |
| ZAFIRA |
| OPEL-VAUXHALL® ADAM |
| AMPERA |
| ASTRA H |
| ASTRA J |
| CABRIO |
| CASCADA |
| CORSA D |
| CORSA E |
| INSIGNA |
| MERIVA |
| MOKKA |
| SIGNUM |
| VECTRA |
| ZAFIRA |
| ASTRA |

| |
|-------------------------|
| OP-11.P5 |
| FOR: MODELO - MODEL |
| BUICK® ALLURE (CANADA) |
| ENCORE |
| LACROSSE |
| REGAL W/O PEPS |
| VERANO |
| CADILLAC® SRX |
| CHEVROLET® (KR) MALIBU |
| CHEVROLET® (USA) CAMARO |
| CAPRICE (PPV) |
| CAPRICE (PPV) |
| CITY EXPRESS |
| COLORADO (CAN) |
| CRUZE |
| EQUINOX |
| EXPRESS |
| IMPALA |
| MALIBU |
| ORLANDO |
| SILVERADO |

| |
|-----------------------|
| OP-11.TL |
| FOR: MODELO - MODEL |
| PONTIAC® G8 |
| OP-WH.P |
| FOR: MODELO - MODEL |
| OPEL-VAUXHALL® SIGNUM |
| VECTRA |
| SIP-4.P3 |
| FOR: MODELO - MODEL |
| MASERATI® COUPE |
| SIP-4.P4 |
| FOR: MODELO - MODEL |
| ALFA ROMEO® 166 |

| |
|---------------------|
| SIX-3.P3 |
| FOR: MODELO - MODEL |
| CITROEN® BERLINGO |
| C5 |
| DISPATCH |
| JUMPY |
| SAXO |
| XSARA |
| XSARA PICASSO |
| FIAT® SCUDO |
| PEUGEOT® EXPERT |
| PARTNER |
| RANCH |

| |
|-------------|
| SONIC |
| SUBURBAN |
| TAHOE |
| TRAX (CAN) |
| VOLT |
| GMC® CANYON |
| DENALI |
| SAVANA |
| SIERRA |
| TERRAIN |
| YUKON |

| |
|---------------------|
| OP-11.TL |
| FOR: MODELO - MODEL |
| PONTIAC® G8 |

| |
|-----------------------|
| OP-WH.P |
| FOR: MODELO - MODEL |
| OPEL-VAUXHALL® SIGNUM |
| VECTRA |

| |
|---------------------|
| SIP-4.P3 |
| FOR: MODELO - MODEL |
| MASERATI® COUPE |

| |
|---------------------|
| SIP-4.P4 |
| FOR: MODELO - MODEL |
| ALFA ROMEO® 166 |

| |
|---------------------|
| SIX-3.P3 |
| FOR: MODELO - MODEL |
| CITROEN® BERLINGO |
| C5 |
| DISPATCH |
| JUMPY |
| SAXO |
| XSARA |
| XSARA PICASSO |
| FIAT® SCUDO |
| PEUGEOT® EXPERT |
| PARTNER |
| RANCH |

| |
|---------------------|
| SMR-1.P |
| FOR: MODELO - MODEL |
| SMART® FORFOUR |
| FORTWO |

| |
|---------------------------------|
| SUZU-14.P2 |
| FOR: MODELO - MODEL |
| FIAT® SEDICI |
| NISSAN® PIXO |
| OPEL-VAUXHALL® AGILA A |
| SUZUKI® ALTO |
| GRAND VITARA |
| SPLASH |
| SWIFT |
| SX4 |
| SUZUKI® (INDIA) MARUTI ALTO K10 |
| MARUTI A-STAR |
| MARUTI RITZ |
| MARUTI SWIFT |

| |
|----------------|
| MARUTI SX4 |
| MARUTI WAGON R |

| |
|---------------------|
| SUZU-20D.P2 |
| FOR: MODELO - MODEL |
| NISSAN® PIXO |

| |
|----------------------|
| SUZU-8.P1 |
| FOR: MODELO - MODEL |
| SUZUKI® GRAND VITARA |
| SANTANA |
| VITARA |

| |
|---------------------|
| TAT-1D.P2 |
| FOR: MODELO - MODEL |
| TATA® ARIA |
| INDICA VISTA |
| INDIGO Ecs |
| MANZA |
| VISTA |

| |
|---------------------|
| TAT-2D.P1 |
| FOR: MODELO - MODEL |
| MAHINDRA® BOLERO |
| SCORPIO |

| |
|----------------------|
| TOYO-15.P2 |
| FOR: MODELO - MODEL |
| SUZUKI® GRAND VITARA |

| |
|---------------------|
| TOYO-18.P |
| FOR: MODELO - MODEL |
| HYUNDAI® I20 |

| |
|-----------------------|
| VA-34.P4 |
| FOR: MODELO - MODEL |
| NISSAN® KUBISTAR |
| RENAULT® KANGOO |
| TWINGO |
| RENAULT DACIA® DUSTER |
| LOGAN |
| SANDERO |
| SYMBOL |

| |
|---------------------|
| ZA-11.P |
| FOR: MODELO - MODEL |

TPX7

| FO-6.P | |
|-------------|-----------------|
| FOR: | MODELO - MODEL |
| FORD® (USA) | TRANSIT CONNECT |

| FO-24.P | | |
|-------------------|------------------|-----------|
| FOR: | MODELO - MODEL | |
| FORD® | B-MAX | |
| | C-MAX | |
| | C-MAX | |
| | ECO SPORT | |
| | EDGE | |
| | FIESTA | |
| | FOCUS | |
| | FOCUS C-MAX | |
| | GALAXY | |
| | KUGA | |
| | MONDEO | |
| | RANGER | |
| | S-MAX | |
| | TOURNEO CONNECT | |
| | TOURNEO COURIER | |
| | TOURNEO CUSTOM | |
| | TRANSIT | |
| TRANSIT CONNECT | | |
| TRANSIT COURIER | | |
| TRANSIT CUSTOM | | |
| FORD® (AUSTRALIA) | FALCON FG | |
| | FIESTA | |
| | FOCUS | |
| | KUGA | |
| | MONDEO | |
| | RANGER | |
| | FORD® (MERCOSUR) | ECO SPORT |
| | | C-MAX |
| | FORD® (USA) | C-MAX |
| | | EDGE |
| ESCAPE | | |
| FIESTA | | |
| FOCUS | | |
| TRANSIT | | |
| TRANSIT CONNECT | | |
| MAZDA® | | BT-50 |

| FO-24.TL2 | |
|-----------|----------------|
| FOR: | MODELO - MODEL |
| FORD® | B-MAX |
| | ECO SPORT |
| | GALAXY |
| | MONDEO |
| | S-MAX |

| FO-30D.P | |
|-------------|----------------|
| FOR: | MODELO - MODEL |
| FORD® (USA) | EDGE |
| | E-SERIES |
| | EXPEDITION |
| | EXPLORER |
| | F-150 |
| | F-250 |
| | F-350 |
| | FLEX |
| | FOCUS |
| | FUSION |
| | MUSTANG |

| | |
|----------|-----------|
| LINCOLN® | RANGER |
| | TAURUS |
| | MARK LT |
| | MKT |
| | MKX |
| MERCURY® | MKZ |
| | NAVIGATOR |
| | MILAN |
| VP6® | MV-1 |

| HY-11.P1 | |
|----------|----------------|
| FOR: | MODELO - MODEL |
| HYUNDAI® | EON |
| KIA® | CARNIVAL |

| HY-11D.P1 | |
|------------|----------------|
| FOR: | MODELO - MODEL |
| HYUNDAI® | CRETA |
| KIA® | HB20 (BRAZIL) |
| | CERATO |
| KIA® (USA) | FORTE |

| HY-18.P | |
|------------|----------------|
| FOR: | MODELO - MODEL |
| HYUNDAI® | I30 |
| | I40 |
| | I40 |
| | IX20 |
| | SONATA |
| KIA® | TUCSON |
| | CARENS |
| | CEE'D |
| | RIO |
| | RIONDO |
| KIA® (USA) | SOUL |
| | SPORTAGE |
| | RIO (CANADA) |

| HY-19D.P1 | |
|----------------|------------------|
| FOR: | MODELO - MODEL |
| HYUNDAI® | VELOSTER |
| HYUNDAI® (USA) | ELANTRA GT (CAN) |
| KIA® | MORNING |
| | PICANTO |

| HY-19.P1 | |
|----------|----------------|
| FOR: | MODELO - MODEL |
| HYUNDAI® | SANTAFE |
| KIA® | SORENTO |

| HY-20.P1 | |
|----------|----------------|
| FOR: | MODELO - MODEL |
| HYUNDAI® | I30 |
| | IONIQ |
| | KONA |
| | YPSILON |
| KIA® | NIRO |
| | PICANTO |
| | RIO |

TPX8+

| DAE-3D.P1 | |
|-----------|----------------|
| FOR: | MODELO - MODEL |
| HOLDEN® | BARINA |
| PONTIAC® | WAVE |

| DAE-3.P4 | |
|------------------|----------------|
| FOR: | MODELO - MODEL |
| CHEVROLET® (USA) | SPARK |

| FI-11.P5 | |
|----------|----------------|
| FOR: | MODELO - MODEL |
| IVECO® | DAILY |

| FI-13.P5 | |
|----------|----------------|
| FOR: | MODELO - MODEL |
| FIAT® | SEICENTO |

| FI-13.P7 | |
|----------|----------------|
| FOR: | MODELO - MODEL |
| FIAT® | PUNTO |

| FI-13.P8 | |
|------------------|----------------|
| FOR: | MODELO - MODEL |
| FIAT® | PUNTO |
| | SIENA |
| FIAT®(S.AMERICA) | PALIO (BRASIL) |

| FI-16.P | |
|-------------------|----------------|
| FOR: | MODELO - MODEL |
| ALFA ROMEO® | 147 |
| | 156 |
| | GT |
| CITROEN® | JUMPER |
| | RELAY |
| FERRARI® | 458 |
| FIAT® | 612 SCAGLIETTI |
| | CALIFORNIA |
| | ALBEA |
| | BRAVO |
| | DOBLO |
| | DUCATO |
| | IDEA |
| | LINEA |
| | MILLE |
| | PUNTO |
| STILO | |
| FIAT® (S.AMERICA) | DOBLO |
| | IDEA |
| | STILO |
| LANCIA® | DELTA |
| | LYBRA |
| | MUSA |
| | THESIS |
| | YPSILON |
| MASERATI® | GRAND SPORT |
| | GRAND TURISMO |
| | QUATTROPORTE |
| PEUGEOT® | BOXER |

| FI-16.P15 | |
|-----------|----------------|
| FOR: | MODELO - MODEL |
| FIAT® | MULTIPLA |

| GM-28.P | |
|------------------|----------------|
| FOR: | MODELO - MODEL |
| CHEVROLET® (USA) | COLORADO (CAN) |
| CADILLAC® | CTS |

| GM-37.P | |
|-----------|----------------|
| FOR: | MODELO - MODEL |
| CADILLAC® | SRX |

| HOND-21.P | | |
|----------------|----------------|-------|
| FOR: | MODELO - MODEL | |
| HOLDEN® | FRONTERA | |
| HONDA® | ACCORD | |
| | ACCORD | |
| | CIVIC | |
| | CR-V | |
| | HR-V | |
| | INSIGHT | |
| | LOGO | |
| | S 2000 | |
| | SHUTTLE | |
| | STREAM | |
| | ISUZU® | AXIOM |
| | ISUZU® (USA) | RODEO |
| | | RODEO |
| OPEL-VAUXHALL® | FRONTERA | |

| HOND-31.P | | |
|-----------|-------------------------|--|
| FOR: | MODELO - MODEL | |
| HONDA® | ACCORD | |
| | CITY | |
| | CIVIC | |
| | CR-V | |
| | EDIX (J) | |
| | FR-V | |
| | JAZZ | |
| | S 2000 | |
| | STREAM | |
| | SPORTVAN | |
| | VOLKSWAGEN® (S.AMERICA) | |

| HU-HAA.P | |
|-------------------------|-----------------|
| FOR: | MODELO - MODEL |
| AUDI® | A1 |
| | A2 |
| | A3 |
| | A3 |
| | A4 |
| | A4 |
| | A6 |
| | A6 |
| | A8 |
| | ALLROAD QUATTRO |
| | ALLROAD QUATTRO |
| | COUPE |
| | COUPE S2 |
| | Q3 |
| | RST 4 |
| | S3 |
| | S4 |
| | S6 |
| | S8 |
| | TT COUPE |
| TT COUPE | |
| TT ROADSTER | |
| TT ROADSTER | |
| AUDI® (USA) | A3 |
| | A4/S4 |
| | A5/S5 |
| | A6/S6 |
| | A8 |
| | TT |
| VOLKSWAGEN® (S.AMERICA) | SAVEIRO |
| | SAVEIRO |

| HU-HAA.P1 | | |
|----------------|----------------|-------|
| FOR: | MODELO - MODEL | |
| AUDI® | A4 | |
| | A6 | |
| | A8 | |
| | CABRIO | |
| | COUPE S2 | |
| | S4 | |
| | S6 | |
| | S8 | |
| | TT COUPE | |
| | TT COUPE | |
| | TT ROADSTER | |
| | AUDI® (USA) | A5/S5 |
| | | A6/S6 |
| A6/S6 | | |
| A8 | | |
| Q5 / Q7 | | |
| LAMBORGHINI® | GALLARDO | |
| | MURCIELAGO | |
| PORSCHE® | 911 | |
| | BOXSTER | |
| PORSCHE® (USA) | 968 | |
| | CAYENNE | |
| SEAT® | ALHAMBRA | |
| | ALHAMBRA | |
| | ALTEA | |

| FOR: | PÁG. | PÁG. | PÁG. | PÁG. |
|------------------------|------|------|------|------|
| ABARTH® | B2 | | | |
| ACURA® (HONDA®) (USA) | B2 | | | |
| ALFA ROMEO® | B2 | B3 | | |
| APRILIA® | B73 | | | |
| APRILIA® (USA) | B73 | | | |
| AUDI® | B3 | B4 | B5 | |
| AUDI® (USA) | B5 | | | |
| BENTLEY® | B5 | | | |
| BMW® | B5 | B6 | B73 | |
| BMW® (USA) | B6 | B7 | | |
| BUICK® | B7 | | | |
| CADILLAC® | B7 | B8 | | |
| CHEVROLET® (KR) | B8 | B9 | | |
| CHEVROLET® (S.AMERICA) | B9 | B10 | | |
| CHEVROLET® (USA) | B10 | B11 | | |
| CHRYSLER® | B11 | B12 | | |
| CITROEN® | B12 | B13 | | |
| DAEWOO® (USA) | B13 | | | |
| DAF® | B69 | | | |
| DAIHATSU® | B13 | B14 | | |
| DERBI® | B73 | | | |
| DODGE® | B14 | | | |
| DUCATI® | B73 | B74 | | |
| EAGLE® | B14 | | | |
| FERRARI® | B14 | | | |
| FIAT® | B14 | B15 | B16 | B17 |
| FIAT® (S.AMERICA) | B17 | | | |
| FIAT® (USA) | B17 | | | |
| FORD® | B17 | B18 | B19 | |
| FORD® (AUSTRALIA) | B19 | | | |
| FORD® (MERCOSUR) | B20 | | | |
| FORD® (SUDAFRIKA) | B20 | | | |
| FORD® (USA) | B20 | B21 | B22 | B69 |
| GILERA® | B74 | | | |
| GMC® | B22 | | | |
| GREAT WALL® | B22 | B23 | | |
| HOLDEN® | B23 | | | |
| HONDA® | B23 | B24 | B74 | B75 |
| HONDA® (AUSTRALIA) | B25 | | | |
| HONDA® (USA) | B25 | | | |
| HUMMER® | B25 | | | |
| HYUNDAI® | B25 | B26 | B27 | B28 |
| HYUNDAI® (AUS) | B28 | | | |

| FOR: | PÁG. | PÁG. | PÁG. | PÁG. |
|--------------------------|------|------|------|------|
| HYUNDAI® (USA) | B28 | B29 | | |
| INFINITI® (NISSAN) | B29 | | | |
| ISUZU® | B29 | B30 | B69 | |
| ISUZU® (USA) | B30 | | | |
| IVECO® | B30 | B69 | | |
| JAGUAR® | B30 | | | |
| JAGUAR® (USA) | B30 | | | |
| JEEP® | B31 | | | |
| KAWASAKI® | B75 | | | |
| KIA® | B31 | B32 | B33 | |
| KIA® (USA) | B33 | | | |
| LAMBORGHINI® | B33 | | | |
| LANCIA® | B33 | B34 | | |
| LAND-RANGE ROVER® | B34 | | | |
| LAND-RANGE ROVER® (USA) | B34 | | | |
| LEXUS® (TOYOTA®) | B34 | B35 | B36 | |
| LEXUS® (TOYOTA®) (JAPON) | B36 | | | |
| LEXUS® (TOYOTA®) (USA) | B36 | | | |
| LINCOLN® | B36 | B37 | | |
| MAHINDRA® | B37 | | | |
| MALAGUTI® | B75 | | | |
| MAN® | B69 | | | |
| MASERATI® | B37 | | | |
| MAZDA® | B37 | B38 | | |
| MAZDA® (AUSTRALIA) | B38 | | | |
| MAZDA® (JAPON) | B38 | | | |
| MAZDA® (SUDAFRIKA) | B38 | | | |
| MAZDA® (USA) | B38 | B39 | | |
| MBK® | B75 | B76 | | |
| MERCEDES® | B39 | B69 | | |
| MERCURY® | B39 | | | |
| MINI® | B39 | B40 | | |
| MITSUBISHI® | B40 | B41 | B42 | |
| MITSUBISHI® (AUSTRALIA) | B42 | | | |
| MITSUBISHI® (USA) | B42 | | | |
| MOTO GUZZI® | B76 | | | |
| NISSAN® | B43 | B44 | B45 | B70 |
| NISSAN® (JAPON) | B45 | | | |
| NISSAN® (USA) | B45 | B46 | | |
| OLDS MOBILE® | B46 | | | |
| OPEL-VAUXHALL® | B46 | B47 | B48 | |
| PANOZ® | B48 | | | |
| PERODUA® | B48 | | | |

| FOR: | PÁG. | PÁG. | PÁG. | PÁG. |
|-------------------------|------|------|------|------|
| PEUGEOT® | B48 | B49 | B76 | |
| PIAGGIO® | B76 | | | |
| PLYMOUTH® | B49 | | | |
| PONTIAC® | B49 | B50 | | |
| PORSCHE® | B50 | | | |
| PORSCHE® (USA) | B50 | | | |
| PROTON® | B50 | | | |
| RENAULT® | B50 | B51 | B70 | |
| RENAULT DACIA® | B51 | B52 | | |
| ROVER® | B52 | | | |
| SAAB® | B52 | | | |
| SAAB® (USA) | B52 | | | |
| SATURN® | B52 | | | |
| SCANIA® | B70 | | | |
| SCION® | B52 | | | |
| SEAT® | B52 | B53 | | |
| SKODA® | B53 | B54 | | |
| SMART® | B54 | | | |
| SSANGYONG® | B54 | | | |
| STELRING® | B70 | | | |
| SUBARU® | B54 | B55 | | |
| SUBARU® (AUS) | B55 | B56 | | |
| SUBARU® (USA) | B55 | B56 | | |
| SUZUKI® | B56 | B57 | B77 | |
| SUZUKI® (INDIA) | B57 | | | |
| SUZUKI® (JAPON) | B57 | | | |
| SUZUKI® (USA) | B57 | B58 | | |
| TAGAZ® | B58 | | | |
| TATA® | B58 | | | |
| TOYOTA® | B58 | B59 | B60 | |
| TOYOTA® (AUSTRALIA) | B60 | | | |
| TOYOTA® (JAPON) | B60 | B61 | | |
| TOYOTA® (SUDAFRIKA) | B61 | | | |
| TOYOTA® (USA) | B61 | B62 | B63 | |
| TRIUMPH® | B77 | | | |
| VESPA® | B77 | | | |
| VOLKSWAGEN® | B63 | B64 | B65 | |
| VOLKSWAGEN® (S.AMERICA) | B65 | | | |
| VOLKSWAGEN® (USA) | B66 | | | |
| VOLVO® | B66 | B67 | B70 | |
| VPG® | B67 | | | |
| YAMAHA® | B77 | B78 | | |

ÍNDICE GENERAL POR REFERENCIA

GENERAL INDEX ACCORDING TO REFERENCE

| REF. | PÁG. | REF. | PÁG. | REF. | PÁG. | REF. | PÁG. | REF. | PÁG. |
|----------|------|-----------|------|-----------|------|----------|------|------------|------|
| AF-14P3 | 19 | FI-13P5 | 20 | HU-HAAP1 | 7 | ME-9P1 | 8 | SIX-3P3 | 16 |
| AU-AHP2 | 5 | FI-13P6 | 21 | HU-HAATL | 7 | ME-HMP1 | 21 | SKO-5P1 | 3 |
| BM-5P4 | 5 | FI-13P7 | 20 | HU-HAATLN | 8 | ME-HMTL | 21 | SMR-1P | 16 |
| BM-6P | 5 | FI-13P8 | 20 | HU-HAATLV | 8 | MHN-1.P | 13 | SSA-1P1 | 16 |
| BM-6P6 | 6 | FI-16P | 20 | HU-HCAP | 8 | MIT-12P | 14 | SUB-2P | 16 |
| BM-6RKE | 6 | FI-16P15 | 20 | HY-11DP1 | 11 | MIT-12P2 | 14 | SUB-3P2 | 17 |
| BM-6RKE1 | 6 | FO-15DCP | 3 | HY-11P1 | 11 | MIT-18P | 14 | SUZU-10P1 | 17 |
| BM-7P | 1 | FO-15DP | 3 | HY-11RKE | 11 | MIT-8DP1 | 14 | SUZU-14P2 | 17 |
| CHR-15P | 1 | FO-16P | 3 | HY-12P1 | 11 | MIT-8DP2 | 14 | SUZU-15DP | 17 |
| CHR-15P1 | 1 | FO-24P | 6 | HY-18P | 11 | NE-18P1 | 14 | SUZU-17DP2 | 17 |
| CHR-19P | 1 | FO-24P2 | 6 | HY-18RKE | 12 | NE-35P3 | 5 | SUZU-17P2 | 17 |
| CIT-1P | 20 | FO-24TL | 6 | HY-19DP1 | 12 | NE-36P2 | 15 | SUZU-20DP2 | 17 |
| DAC-3DP4 | 1 | FO-24TL2 | 7 | HY-19P1 | 12 | NE-38P4 | 15 | SUZU-8IP1 | 17 |
| DAC-4DP | 1 | FO-30DP | 3 | HY-20P1 | 12 | NE-40P1 | 15 | SUZU-8P1 | 17 |
| DAC-6DP | 1 | FO-6P | 6 | HY-4P1 | 11 | NE-45P1 | 15 | TAT-1DP2 | 18 |
| DAE-3DP1 | 1 | FO-6TL | 6 | HY-5P1 | 11 | NE-51P2 | 15 | TAT-2DP1 | 18 |
| DAE-3DP4 | 1 | FO-6TL2 | 6 | HY-6DP1 | 11 | NE-52P2 | 15 | TOYO-10P1 | 18 |
| DAE-3P1 | 2 | FO-TXP | 3 | HY-9P1 | 11 | OP-10P | 8 | TOYO-15P | 18 |
| DAE-3P4 | 2 | GM-27P | 4 | ISU-3DP1 | 12 | OP-11P1 | 8 | TOYO-15P2 | 18 |
| DAE-3P5 | 2 | GM-28P | 4 | ISU-3DP2 | 12 | OP-11P2 | 8 | TOYO-17P | 18 |
| DAE-4DP1 | 2 | GM-30P | 4 | ISU-5P3 | 12 | OP-11P5 | 9 | TOYO-18P | 18 |
| DAE-4DP2 | 2 | GM-37P | 4 | JAU-1P | 18 | OP-11TL | 9 | TOYO-19P | 19 |
| DAE-4P1 | 2 | GM-43P | 4 | JAU-2P | 18 | OP-11TL2 | 9 | TOYO-20DP | 19 |
| DAE-4P2 | 2 | GM-49DP | 4 | KAW-16P1 | 12 | OP-DP | 9 | TOYO-20DP1 | 19 |
| DAE-6P | 2 | GM-4P1 | 4 | KAW-9P1 | 12 | OP-DTL | 9 | TOYO-30P | 19 |
| DAI-1IP1 | 2 | HOND-21P | 4 | KI-2DP | 13 | OP-DTL2 | 9 | TOYO-36P | 19 |
| DAI-1P1 | 3 | HOND-24P1 | 4 | KI-2P | 13 | OP-SP | 9 | VA-34P4 | 21 |
| DAI-3P1 | 3 | HOND-31P | 5 | KI-7P | 13 | OP-STL | 9 | VO-2DP | 10 |
| DAT-15P2 | 15 | HOND-53P1 | 5 | KI-8DP | 13 | OP-STL2 | 9 | VO-2LP | 10 |
| DAT-15P3 | 16 | HOND-54P1 | 5 | KI-9P | 13 | OP-WHP | 10 | VO-2P | 10 |
| DAT-15P4 | 16 | HOND-55P | 5 | MAZ-10DP | 13 | OP-WHTL | 10 | VO-2TL | 10 |
| DAT-6P2 | 15 | HOND-56P | 5 | MAZ-10DP2 | 13 | OP-WHTL2 | 10 | VO-8P | 10 |
| DAT-6P4 | 15 | HU-2P1 | 7 | MAZ-11DP | 14 | OP-WYP | 10 | YAMA-26DP2 | 21 |
| DCT-1P | 3 | HU-5P | 7 | MAZ-11DP2 | 14 | PRO-1P | 16 | ZA-11P | 21 |
| FI-11P5 | 19 | HU-6P | 7 | MAZ-12P1 | 14 | SAA-1P | 16 | ZA-14P | 21 |
| FI-13P2 | 19 | HU-DHP2 | 7 | MAZ-9DP | 13 | SAA-3P | 16 | ZA-9P | 21 |
| FI-13P3 | 19 | HU-DHP3 | 7 | ME-16P | 8 | SIP-4P3 | 20 | | |
| FI-13P4 | 20 | HU-HAAP | 7 | ME-7P1 | 8 | SIP-4P4 | 20 | | |

AUTOMÓVIL-CAMIONETA

AUTOMOBILA-KAMIONETA



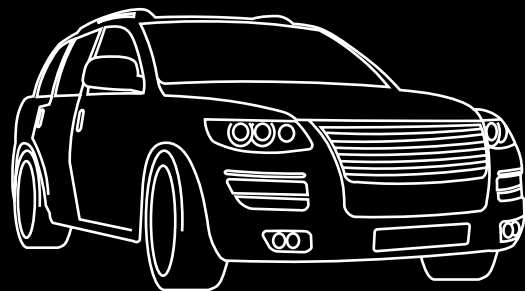

CAR-PICK UP TRUCK

VOITURE-CAMIONNETTE

AUTO-KLEINTRANSPORTER













THE KEY TO EXCELLENCE
GLOBALLY UNLOCKING MILLIONS OF DOORS DAILY

| FOR: |  |  |  |  | TRS-5000 EVO | EVO XPERT | Programming TP |  | |
|--------------------------------------|---|---|---|---|-----------------|--------------|-------------------|---|--|
| ABARTH® | 124 SPIDER | 2016- | PHI/CR3 | DEALER KEY | | | - | | |
| | 500 | 2008- | PHI/CR2 | FI-16P | TPX4/TPX5 | TPX4/TPX5 | - | 20 | |
| | GRANDE PUNTO | 2007-2010 | PHI/CR2 | FI-16P | TPX4/TPX5 | TPX4/TPX5 | - | 20 | |
| | PUNTO | 2012-2014 | PHI/CR2 | FI-16P | TPX4/TPX5 | TPX4/TPX5 | - | 20 | |
| | PUNTO EVO | 2010-2012 | PHI/CR2 | FI-16P | TPX4/TPX5 | TPX4/TPX5 | - | 20 | |
| ACURA® (HONDA®) (USA) | CL | 1998-2003 | MEG/- | HOND-21P | TP05 | TP05 | TP03/TP05** | 4 | |
| | CSX (CANADA) | 2006-2011 | PHI/CR2 | HOND-31P | TPX4/TPX5 | TPX4/TPX5 | TP12HN | 5 | |
| | EL (CANADA) | 2001-2002 | MEG/- | HOND-21P | TP05 | TP05 | TP03/TP05** | 4 | |
| | | 2003-2005 | MEG/- | HOND-31P | TP05 | TP05 | TP03/TP05** | 5 | |
| | ILX | 2013-2015 | PHI/CR2 | DEALER KEY | | | - | | |
| | | 2016- | PHI/CR3 | DEALER KEY | | | - | | |
| | INTEGRA | 2000-2001 | MEG/- | HOND-21P | TP05 | TP05 | TP03/TP05** | 4 | |
| | MDX | 2001-2006 | MEG/- | HOND-21P | TP05 | TP05 | TP03/TP05** | 4 | |
| | | 2007-2013 | PHI/CR2 | HOND-31P | TPX4/TPX5 | TPX4/TPX5 | TP12HN | 5 | |
| | | 2014- | PHI/CR2 | DEALER KEY | | | - | | |
| | NSX | 1997-2005 | MEG/- | HOND-21P | TP05 | TP05 | TP03/TP05** | 4 | |
| | | 2017- | PHI/CR3 | DEALER KEY | | | - | | |
| | RDX | 2007-2012 | PHI/CR2 | HOND-31P | TPX4/TPX5 | TPX4/TPX5 | TP12HN | 5 | |
| | | 2013-2015 | PHI/CR2 | DEALER KEY | | | - | | |
| | | 2016- | PHI/CR3 | DEALER KEY | | | - | | |
| | RL | 1996-2004 | MEG/- | HOND-21P | TP05 | TP05 | TP03/TP05** | 4 | |
| | | 1996-2004 | MEG/- | ORIGINAL | | | - | | |
| | | 2005-2009 | PHI/CR2 | HOND-21P | TPX4/TPX5 | TPX4/TPX5 | TP12HN | 4 | |
| | RLX | 2014-2015 | PHI/CR2 | DEALER KEY | | | - | | |
| | | 2016- | PHI/CR3 | DEALER KEY | | | - | | |
| RSX | 2002-2006 | MEG/- | HOND-21P | TP05 | TP05 | TP03/TP05** | 4 | | |
| TL | 1999-2003 | MEG/- | HOND-21P | TP05 | TP05 | TP03/TP05** | 4 | | |
| | 2004-2006 | PHI/CR2 | HOND-21P | TPX4/TPX5 | TPX4/TPX5 | TP12HN | 4 | | |
| | 2007-2014 | PHI/CR2 | HOND-31P | TPX4/TPX5 | TPX4/TPX5 | TP12HN | 5 | | |
| | 2007-2014 | PHI/CR2 | DEALER KEY | | | - | | | |
| TLX | 2015- | PHI/CR3 | DEALER KEY | | | - | | | |
| TSX | 2004-2008 | PHI/CR2 | HOND-21P | TPX4/TPX5 | TPX4/TPX5 | TP12HN | 4 | | |
| | 2009-2014 | PHI/CR2 | HOND-31P | TPX4/TPX5 | TPX4/TPX5 | TP12HN | 5 | | |
| ZDX | 2010-2012 | PHI/CR2 | HOND-31P | TPX4/TPX5 | TPX4/TPX5 | TP12HN | 5 | | |
| | 2010-2013 | PHI/CR2 | DEALER KEY | | | - | | | |
| ALFA ROMEO® | 145 | 1995-1998 | PHI/- | FI-13P3 | TP01/TP05 | TP01/TP05 | TP01/TP05** | 19 | |
| | 146 | 1995-1998 | PHI/- | FI-13P3 | TP01/TP05 | TP01/TP05 | TP01/TP05** | 19 | |
| | 147 | 2000-2010 | MEG/CR | FI-16P | TPX8+ | TPX8+ | - | 20 | |
| | 155 | 1995-1998 | PHI/- | FI-13P3 | TP01/TP05 | TP01/TP05 | TP01/TP05** | 19 | |
| | | 156 | 1998-2001 | PHI/CR | ORIGINAL | | | - | |
| | | 2001-2003 | PHI/CR2 | FI-16P | TPX4/TPX5 | TPX4/TPX5 | - | 20 | |
| | | 2003-2007 | MEG/CR | FI-16P | TPX8+ | TPX8+ | - | 20 | |
| | 156 SPORT WAGON | 2000-2001 | PHI/CR | ORIGINAL | | | - | | |
| | | 2001-2007 | PHI/CR2 | FI-16P | TPX4/TPX5 | TPX4/TPX5 | - | 20 | |
| | | 2001-2007 | PHI/CR2 | ORIGINAL | | | - | | |
| | 159 | 2005-2011 | PHI/CR | ORIGINAL | | | - | | |
| | 164 | 1995-1998 | PHI/- | AF-14P3 | TP01/TP05 | TP01/TP05 | TP01/TP05** | 19 | |
| | 164 PLUS | 1995-1998 | PHI/- | SIP-4P3 | TP01/TP05 | TP01/TP05 | TP01/TP05** | 20 | |
| 166 | 1998-2004 | PHI/CR | SIP-4P4 | | | - | 20 | | |

AUTOMÓVIL - CAMIONETA





CAR-PICK UP TRUCK





| FOR: |  |  |  |  | TRS-5000 EVO | EVO XPERT | Programming TP |  |
|-----------|---|---|---|---|-----------------|--------------|-------------------|---|
| | | 1998-2004 | PHI/CR | ORIGINAL | | | - | |
| | | 2000-2004 | PHI/CR2 | SIP-4P4 | TPX4/TPX5 | TPX4/TPX5 | - | 20 |
| | | 2001-2008 | PHI/CR2 | ORIGINAL | | | - | |
| | | 2004-2008 | PHI/CR2 | FI-16P | TPX4/TPX5 | TPX4/TPX5 | - | 20 |
| | BRERA | 2005-2010 | PHI/CR2 | ORIGINAL | | | - | |
| | GIULIETTA | 2010- | PHI/CR2 | FI-16P | TPX4/TPX5 | TPX4/TPX5 | - | 20 |
| | | 2010- | PHI/CR2 | ORIGINAL | | | - | |
| | GT | 2003-2010 | MEG/CR | FI-16P | TPX8+ | TPX8+ | - | 20 |
| | GTV | 1995-1998 | PHI/- | FI-13P3 | TP01/TP05 | TP01/TP05 | TP01/TP05** | 19 |
| | MITO | 2008 - | PHI/CR2 | FI-16P | TPX4/TPX5 | TPX4/TPX5 | - | 20 |
| | | 2008 - | PHI/CR2 | ORIGINAL | | | - | |
| | SPIDER | 1995-1998 | PHI/- | FI-13P3 | TP01/TP05 | TP01/TP05 | TP01/TP05** | 19 |
| 2006-2010 | | PHI/CR2 | ORIGINAL | | | - | | |
| AUDI® | 80/90 | 1996- | MEG/- | AU-AHP2 | TP05 | TP05 | TP03/TP05** | 5 |
| | A1 | 2010-2015 | MEG/CR | HU-HAAP | TPX8+ | TPX8+ | TP25* | 7 |
| | | 2010-2015 | MEG/CR | ORIGINAL | | | - | |
| | A2 | 1999-2000 | MEG/CR | HU-HAATLV | TPX8+ | TPX8+ | TP08 | 8 |
| | | 2000-2005 | MEG/CR | HU-HAAP | TPX8+ | TPX8+ | TP08 | 7 |
| | | 2000-2005 | MEG/CR | HU-HAATLN | TPX8+ | TPX8+ | TP08 | 8 |
| | A3 | 1996-1997 | MEG/- | HU-HAAP | TP05 | TP05 | TP03/TP05** | 7 |
| | | 1996-1997 | MEG/- | HU-HAATLV | TP05 | TP05 | TP03/TP05** | 8 |
| | | 1997-2000 | MEG/CR | HU-HAATLV | TPX8+ | TPX8+ | TP08 | 8 |
| | | 1997-2003 | MEG/CR | HU-HAAP | TPX8+ | TPX8+ | TP08 | 7 |
| | | 2001-2003 | MEG/CR | HU-HAATLN | TPX8+ | TPX8+ | TP08 | 8 |
| | | 2003-2012 | MEG/CR | HU-HAAP | TPX8+ | TPX8+ | TP25* | 7 |
| | | 2003-2012 | MEG/CR | HU-HAATLN | TPX8+ | TPX8+ | TP25* | 8 |
| | | 2003-2012 | MEG/CR | ORIGINAL | | | - | |
| | | 2012- | MEG/AES | HU-5P | | | - | 7 |
| | 2012- | MEG/AES | ORIGINAL | | | - | | |
| | A4 | 1995-1996 | MEG/- | AU-AHP2 | TP05 | TP05 | TP03/TP05** | 5 |
| | | 1996-1997 | MEG/- | HU-HAAP | TP05 | TP05 | TP03/TP05** | 7 |
| | | 1996-1997 | MEG/- | HU-HAATLV | TP05 | TP05 | TP03/TP05** | 8 |
| | | 1997-2000 | MEG/CR | HU-HAATLV | TPX8+ | TPX8+ | TP08 | 8 |
| | | 1997-2004 | MEG/CR | HU-HAAP | TPX8+ | TPX8+ | TP08 | 7 |
| | | 1997-2004 | MEG/CR | HU-HAAP1 | TPX8+ | TPX8+ | TP08 | 7 |
| | | 2001-2003 | MEG/CR | HU-HAATLN | TPX8+ | TPX8+ | TP08 | 8 |
| 2004-2008 | | MEG/CR | HU-HAAP | TPX8+ | TPX8+ | TP25* | 7 | |
| 2004-2008 | | MEG/CR | HU-HAATLN | TPX8+ | TPX8+ | TP25* | 8 | |
| 2004-2008 | | MEG/CR | ORIGINAL | | | - | | |
| 2009- | | PHI/CR3 | DEALER KEY | | | - | | |
| A5 | 2008- | PHI/CR3 | DEALER KEY | | | - | | |
| A6 | 1995-1996 | MEG/- | AU-AHP2 | TP05 | TP05 | TP03/TP05** | 5 | |
| | 1996-1997 | MEG/- | HU-HAAP | TP05 | TP05 | TP03/TP05** | 7 | |
| | 1996-1997 | MEG/- | HU-HAATLV | TP05 | TP05 | TP03/TP05** | 8 | |
| | 1997-2000 | MEG/CR | HU-HAATLV | TPX8+ | TPX8+ | TP08 | 8 | |
| | 1997-2004 | MEG/CR | HU-HAAP | TPX8+ | TPX8+ | TP08 | 7 | |
| | 1997-2004 | MEG/CR | HU-HAAP1 | TPX8+ | TPX8+ | TP08 | 7 | |
| | 2001-2004 | MEG/CR | HU-HAATLN | TPX8+ | TPX8+ | TP08 | 8 | |
| | 2004-2006 | MEG/CR | HU-HAAP | TPX8+ | TPX8+ | TP25* | 7 | |
| 2004-2006 | MEG/CR | HU-HAATLN | TPX8+ | TPX8+ | TP25* | 8 | | |

| FOR: |  |  |  |  | TRS-5000 EVO | EVO XPERT | Programming TP |  |
|-----------------|---|---|---|---|-----------------|--------------|-------------------|---|
| | | 2004-2006 | MEG/CR | ORIGINAL | | | - | |
| | | 2006-2011 | SOK/CR | ORIGINAL | | | - | |
| | | 2012- | PHI/CR3 | DEALER KEY | | | - | |
| A7 | | 2010- | PHI/CR3 | DEALER KEY | | | - | |
| A8 | | 1995-1996 | MEG/- | AU-AHP2 | TP05 | TP05 | TP03/TP05** | 5 |
| | | 1996-1997 | MEG/- | HU-HAAP | TP05 | TP05 | TP03/TP05** | 7 |
| | | 1996-1997 | MEG/- | HU-HAATLV | TP05 | TP05 | TP03/TP05** | 8 |
| | | 1997-2000 | MEG/CR | HU-HAATLV | TPX8+ | TPX8+ | TP08 | 8 |
| | | 1997-2004 | MEG/CR | HU-HAAP | TPX8+ | TPX8+ | TP08 | 7 |
| | | 1997-2004 | MEG/CR | HU-HAAP1 | TPX8+ | TPX8+ | TP08 | 7 |
| | | 2001-2004 | MEG/CR | HU-HAATLN | TPX8+ | TPX8+ | TP08 | 8 |
| | | 2004-2009 | PHI/CR2 | HU-HAAP | TPX4/TPX5 | TPX4/TPX5 | - | 7 |
| | | 2004-2009 | PHI/CR2 | HU-HAATLN | TPX4/TPX5 | TPX4/TPX5 | - | 8 |
| | | 2009- | PHI/CR3 | DEALER KEY | | | - | |
| ALLROAD QUATTRO | | 2000-2005 | MEG/CR | HU-HAAP | TPX8+ | TPX8+ | TP08 | 7 |
| | | 2000-2005 | MEG/CR | HU-HAATLN | TPX8+ | TPX8+ | TP08 | 8 |
| | | 2006-2011 | MEG/CR | HU-HAAP | TPX8+ | TPX8+ | TP25* | 7 |
| | | 2006-2011 | MEG/CR | HU-HAATLN | TPX8+ | TPX8+ | TP25* | 8 |
| | | 2006-2011 | MEG/CR | ORIGINAL | | | - | |
| CABRIO | | 1995-1996 | MEG/- | AU-AHP2 | TP05 | TP05 | TP03/TP05** | 5 |
| | | 1996-1997 | MEG/- | HU-HAAP | TP05 | TP05 | TP03/TP05** | 7 |
| | | 1997-2004 | MEG/CR | HU-HAAP1 | TPX8+ | TPX8+ | TP08 | 7 |
| COUPE | | 1995-1996 | MEG/- | AU-AHP2 | TP05 | TP05 | TP03/TP05** | 5 |
| | | 1996-1997 | MEG/- | HU-HAAP | TP05 | TP05 | TP03/TP05** | 7 |
| | | 1997-2004 | MEG/CR | HU-HAAP | TPX8+ | TPX8+ | TP08 | 7 |
| COUPE S2 | | 1995-1996 | MEG/- | AU-AHP2 | TP05 | TP05 | TP03/TP05** | 5 |
| | | 1996-1997 | MEG/- | HU-HAAP | TP05 | TP05 | TP03/TP05** | 7 |
| | | 1997-2004 | MEG/CR | HU-HAAP | TPX8+ | TPX8+ | TP08 | 7 |
| | | 1997-2004 | MEG/CR | HU-HAAP1 | TPX8+ | TPX8+ | TP08 | 7 |
| Q3 | | 2011-2014 | MEG/CR | HU-HAAP | TPX8+ | TPX8+ | TP25* | 7 |
| | | 2011-2014 | MEG/CR | ORIGINAL | | | - | |
| Q5 | | 2009- | PHI/CR3 | DEALER KEY | | | - | |
| | | 2009- | PHI/CR3 | ORIGINAL | | | - | |
| Q7 | | 2006- | PHI/CR2 | HU-HAAP | TPX4/TPX5 | TPX4/TPX5 | - | 7 |
| | | 2006- | PHI/CR2 | HU-HAATLN | TPX4/TPX5 | TPX4/TPX5 | - | 8 |
| | | 2006- | PHI/CR2 | ORIGINAL | | | - | |
| RST 4 | | 2006- | MEG/CR | HU-HAAP | TPX8+ | TPX8+ | TP08 | 7 |
| S3 | | 2001-2004 | MEG/CR | HU-HAAP | TPX8+ | TPX8+ | TP08 | 7 |
| | | 2001-2004 | MEG/CR | HU-HAATLN | TPX8+ | TPX8+ | TP08 | 8 |
| S4 | | 2002-2005 | MEG/CR | HU-HAAP | TPX8+ | TPX8+ | TP08 | 7 |
| | | 2002-2005 | MEG/CR | HU-HAAP1 | TPX8+ | TPX8+ | TP08 | 7 |
| | | 2002-2005 | MEG/CR | HU-HAATLN | TPX8+ | TPX8+ | TP08 | 8 |
| S6 | | 1995-1996 | MEG/- | AU-AHP2 | TP05 | TP05 | TP03/TP05** | 5 |
| | | 1996-1997 | MEG/- | HU-HAAP | TP05 | TP05 | TP03/TP05** | 7 |
| | | 1996-1997 | MEG/- | HU-HAATLV | TP05 | TP05 | TP03/TP05** | 8 |
| | | 1997-2004 | MEG/CR | HU-HAATLV | TPX8+ | TPX8+ | TP08 | 8 |
| | | 1997-2004 | MEG/CR | HU-HAAP | TPX8+ | TPX8+ | TP08 | 7 |
| | | 1997-2004 | MEG/CR | HU-HAAP1 | TPX8+ | TPX8+ | TP08 | 7 |
| | | 1997-2004 | MEG/CR | HU-HAATLN | TPX8+ | TPX8+ | TP08 | 8 |
| S8 | | 1999-2004 | MEG/CR | HU-HAAP | TPX8+ | TPX8+ | TP08 | 7 |

AUTOMÓVIL - CAMIONETA





CAR-PICK UP TRUCK



| FOR: |  |  |  |  | TRS-5000 EVO | EVO XPERT | Programming TP |  | |
|-------------|---|---|---|---|-----------------|--------------|-------------------|---|---|
| | TT COUPE | 1999-2004 | MEG/CR | HU-HAAP1 | TPX8+ | TPX8+ | TP08 | 7 | |
| | | 1999-2004 | MEG/CR | HU-HAATLN | TPX8+ | TPX8+ | TP08 | 8 | |
| | | 1998-2006 | MEG/CR | HU-HAAP | TPX8+ | TPX8+ | TP08 | 7 | |
| | | 1998-2006 | MEG/CR | HU-HAAP1 | TPX8+ | TPX8+ | TP08 | 7 | |
| | | 2006-2014 | MEG/CR | HU-HAAP | TPX8+ | TPX8+ | TP25* | 7 | |
| | | 2006-2014 | MEG/CR | HU-HAAP1 | TPX8+ | TPX8+ | TP25* | 7 | |
| | | 2006-2014 | MEG/CR | ORIGINAL | | | - | | |
| | | 2015- | PHI/CR3 | DEALER KEY | | | - | | |
| | | TT ROADSTER | 1998-2004 | MEG/CR | HU-HAAP | TPX8+ | TPX8+ | TP08 | 7 |
| | | | 1998-2005 | MEG/CR | HU-HAAP1 | TPX8+ | TPX8+ | TP08 | 7 |
| 2005- | MEG/CR | | HU-HAAP | TPX8+ | TPX8+ | TP25* | 7 | | |
| AUDI® (USA) | A3 | 2006-2015 | MEG/CR | HU-HAAP | TPX8+ | TPX8+ | TP08 | 7 | |
| | | 2012- | MEG/AES | HU-5P | | | - | 7 | |
| | | 2012- | MEG/AES | HU-6P | | | - | 7 | |
| | | 2006-2015 | MEG/CR | DEALER KEY | | | - | | |
| | A4/S4 | 2006-2015 | MEG/CR | HU-HAAP | TPX8+ | TPX8+ | TP08 | 7 | |
| | | 2006-2015 | MEG/CR | DEALER KEY | | | - | | |
| | A5/S5 | 2001-2005 | MEG/CR | HU-HAAP | TPX8+ | TPX8+ | TP08 | 7 | |
| | | 2001-2005 | MEG/CR | HU-HAAP1 | TPX8+ | TPX8+ | TP08 | 7 | |
| | | 2008-2015 | MEG/CR | DEALER KEY | | | - | | |
| | A6/S6 | 2001-2005 | MEG/CR | HU-HAAP | TPX8+ | TPX8+ | TP08 | 7 | |
| | | 2001-2005 | MEG/CR | HU-HAAP1 | TPX8+ | TPX8+ | TP08 | 7 | |
| | | 2006-2015 | MEG/CR | HU-HAAP1 | TPX8+ | TPX8+ | TP25* | 7 | |
| | | 2006-2013 | MEG/CR | DEALER KEY | | | - | | |
| | A8 | 1997-2000 | MEG/CR | HU-HAAP | TPX8+ | TPX8+ | TP08 | 7 | |
| | | 1997-2000 | MEG/CR | HU-HAAP1 | TPX8+ | TPX8+ | TP08 | 7 | |
| | A8/S8 | 2001-2007 | MEG/CR | DEALER KEY | | | - | | |
| | | 2008-2015 | MEG/CR | DEALER KEY | | | - | | |
| | Q5 / Q7 | 2007-2015 | MEG/CR | HU-HAAP1 | TPX8+ | TPX8+ | TP25* | 7 | |
| | | 2007-2015 | MEG/CR | DEALER KEY | | | - | | |
| | TT | 2000-2004 | MEG/CR | HU-HAAP | TPX8+ | TPX8+ | TP08 | 7 | |
| | | 2000-2004 | MEG/CR | HU-HAAP1 | TPX8+ | TPX8+ | TP08 | 7 | |
| | | 2005-2015 | MEG/CR | HU-HAAP1 | TPX8+ | TPX8+ | TP25* | 7 | |
| 2005-2015 | | MEG/CR | DEALER KEY | TPX8+ | TPX8+ | TP25* | | | |
| BENTLEY® | ARNAGE | 1998-2004 | PHI/CR | ORIGINAL | | | - | | |
| | CONT. GT | 2003-2008 | PHI/CR2 | ORIGINAL | | | - | | |
| | CONTINENTAL GTC | 2003-2009 | PHI/CR2 | DEALER KEY | | | - | | |
| | | 2003-2009 | PHI/CR2 | ORIGINAL | | | - | | |
| | CONTINENTAL SUPER SPORT | 2003-2009 | PHI/CR2 | DEALER KEY | | | - | | |
| BMW® | SERIE : 1 | 2004-2011 | PHI/CR2 | BM-6RKE | TPX4/TPX5 | TPX4/TPX5 | TP12* | 6 | |
| | | 2004-2013 | PHI/CR2 | DEALER KEY | | | - | | |
| | | 2011- | PHI/CR3 | DEALER KEY | | | - | | |
| | SERIE : 2 | 2014- | PHI/CR3 | DEALER KEY | | | - | | |
| | SERIE : 3 | 1995-2001 | PHI/- | ORIGINAL | | | - | | |
| | | 2002-2006 | PHI/EVO. | ORIGINAL | | | - | | |
| | | 2005-2011 | PHI/CR2 | BM-6RKE | TPX4/TPX5 | TPX4/TPX5 | TP12* | 6 | |
| | | 2005-2013 | PHI/CR2 | ORIGINAL | | | - | | |
| | SERIE : 3GT | 2011- | PHI/CR3 | DEALER KEY | | | - | | |
| | | 2013- | PHI/CR3 | DEALER KEY | | | - | | |

| FOR: |  |  |  |  | TRS-5000 EVO | EVO XPERT | Programming TP |  |
|-------------------|---|---|---|---|-----------------|--------------|-------------------|---|
| | SERIE : 4 | 2013- | PHI/CR3 | DEALER KEY | | | - | |
| | SERIE : 5 | 1996-2003 | PHI/- | ORIGINAL | | | - | |
| | | 2003-2010 | PHI/CR2 | BM-6RKE | TPX4/TPX5 | TPX4/TPX5 | TP12* | 6 |
| | | 2010- | PHI/CR3 | DEALER KEY | | | - | |
| | SERIE : 5GT | 2010- | PHI/CR3 | DEALER KEY | | | - | |
| | SERIE : 6 | 2004-2011 | PHI/CR2 | BM-6RKE | TPX4/TPX5 | TPX4/TPX5 | TP12* | 6 |
| | | 2004-2011 | PHI/CR2 | DEALER KEY | | | - | |
| | | 2011- | PHI/CR3 | DEALER KEY | | | - | |
| | SERIE : 7 | 1994-2001 | PHI/EVO. | ORIGINAL | | | - | |
| | | 2002-2008 | PHI/CR2 | BM-6P6 | TPX4 | TPX4 | TP12* | 6 |
| | | 2002-2008 | PHI/CR2 | DEALER KEY | | | - | |
| | | 2008-2015 | PHI/CR3 | DEALER KEY | | | - | |
| | SERIE : 8 | 1995-1999 | PHI/- | ORIGINAL | | | - | |
| | X 1 | 2009-2012 | PHI/CR2 | BM-6RKE | TPX4/TPX5 | TPX4/TPX5 | TP12* | 6 |
| | | 2009-2012 | PHI/CR2 | DEALER KEY | | | - | |
| | | 2012- | PHI/CR3 | DEALER KEY | | | - | |
| | X 3 | 2003-2010 | PHI/EVO. | ORIGINAL | | | - | |
| | | 2011- | PHI/CR3 | DEALER KEY | | | - | |
| | X 4 | 2014- | PHI/CR3 | DEALER KEY | | | - | |
| | X 5 | 1999-2003 | PHI/- | ORIGINAL | | | - | |
| | | 2004-2006 | PHI/EVO. | ORIGINAL | | | - | |
| | | 2007-2013 | PHI/CR2 | BM-6RKE | TPX4/TPX5 | TPX4/TPX5 | TP12* | 6 |
| | | 2007-2013 | PHI/CR3 | DEALER KEY | | | - | |
| | | 2007-2013 | PHI/CR3 | ORIGINAL | | | - | |
| | | 2013-2018 | PHI/CR3 | DEALER KEY | | | - | |
| | X 6 | 2008-2013 | PHI/CR2 | BM-6RKE | TPX4/TPX5 | TPX4/TPX5 | TP12* | 6 |
| | | 2008-2013 | PHI/CR2 | DEALER KEY | | | - | |
| | | 2014-2019 | PHI/CR3 | DEALER KEY | | | - | |
| | Z 3 | 1995-2002 | PHI/- | ORIGINAL | | | - | |
| | Z 4 | 2003-2008 | PHI/EVO. | ORIGINAL | | | - | |
| | | 2009-2012 | PHI/CR2 | BM-6RKE | TPX4/TPX5 | TPX4/TPX5 | TP12* | 6 |
| | | 2009-2012 | PHI/CR2 | DEALER KEY | | | - | |
| | | 2013- | PHI/CR3 | DEALER KEY | | | - | |
| | Z 8 | 2000-2003 | PHI/EVO. | ORIGINAL | | | - | |
| BMW® (USA) | SERIE : 1 | 2004-2011 | PHI/CR2 | BM-5P4 | TPX4/TPX5 | TPX4/TPX5 | TP12* | 5 |
| | SERIE : 1 W/PROX | 2008-2014 | PHI/CR2 | BM-6P6 | TPX4/TPX5 | TPX4/TPX5 | TP12* | 6 |
| | SERIE : 1 (128i - 135i) | 2008-2011 | PHI/CR2 | BM-6RKE | TPX4/TPX5 | TPX4/TPX5 | TP12* | 6 |
| | SERIE : 3 | 1995-1998 | PHI/CR2 | BM-5P4 | TPX4/TPX5 | TPX4/TPX5 | TP12* | 5 |
| | | 1999-2007 | PHI/CR2 | BM-5P4 | TPX4/TPX5 | TPX4/TPX5 | TP12* | 5 |
| | SERIE : 3 | 2005-2011 | PHI/CR2 | BM-6P6 | TPX4/TPX5 | TPX4/TPX5 | TP12* | 6 |
| | SERIE : 3 W/PROX | 2006-2011 | PHI/CR2 | BM-6P6 | TPX4/TPX5 | TPX4/TPX5 | TP12* | 6 |
| | SERIE : 3 | 2008-2011 | PHI/CR2 | DEALER KEY | | | - | |
| | SERIE : 5 | 1997-2003 | -/- | DEALER KEY | | | - | |
| | | 2003-2010 | PHI/CR2 | BM-6P6 | TPX4/TPX5 | TPX4/TPX5 | TP12* | 6 |
| | | 2004-2007 | PHI/CR2 | DEALER KEY | | | - | |
| | | 2008-2009 | PHI/CR2 | DEALER KEY | | | - | |
| | | 2006-2011 | PHI/CR2 | BM-6P6 | TPX4/TPX5 | TPX4/TPX5 | TP12* | 6 |
| | SERIE : 6 | 2004-2011 | PHI/CR2 | BM-6P6 | TPX4/TPX5 | TPX4/TPX5 | TP12* | 6 |
| | | 2005-2007 | PHI/CR2 | BM-6P6 | TPX4/TPX5 | TPX4/TPX5 | TP12* | 6 |
| | | 2008-2009 | PHI/CR2 | BM-6P6 | TPX4/TPX5 | TPX4/TPX5 | TP12* | 6 |

AUTOMÓVIL - CAMIONETA





CAR-PICK UP TRUCK



| FOR: |  |  |  |  | TRS-5000 EVO | EVO XPERT | Programming TP |  |
|---------------|---|---|---|---|-----------------|--------------|-------------------|---|
| | SERIE : 7 | 1995-1996 | PHI/CR2 | BM-5P4 | TPX4/TPX5 | TPX4/TPX5 | TP12* | 5 |
| | | 1997-2002 | PHI/CR2 | BM-5P4 | TPX4/TPX5 | TPX4/TPX5 | TP12* | 5 |
| | | 2003-2007 | PHI/CR2 | BM-6RKE1 | TPX4/TPX5 | TPX4/TPX5 | TP12* | 6 |
| | | 2002-2008 | PHI/CR2 | BM-6RKE | TPX4/TPX5 | TPX4/TPX5 | TP12* | 6 |
| | | 2008-2009 | PHI/CR2 | BM-6RKE1 | TPX4/TPX5 | TPX4/TPX5 | TP12* | 6 |
| | SERIE : 8 | 1995-1995 | -/- | BM-5P4 | TPX4/TPX5 | TPX4/TPX5 | TP12* | 5 |
| | SERIE : M3 & M5 | 2000-2007 | PHI/CR2 | BM-6P6 | TPX4/TPX5 | TPX4/TPX5 | TP12* | 6 |
| | M5 & M6 SEDAN | 2008-2008 | PHI/CR2 | BM-6P6 | TPX4/TPX5 | TPX4/TPX5 | TP12* | 6 |
| | X3 | 2004-2007 | PHI/CR2 | BM-5P4 | TPX4/TPX5 | TPX4/TPX5 | TP12* | 5 |
| | X 3 | 2007-2007 | PHI/CR2 | BM-6P6 | TPX4/TPX5 | TPX4/TPX5 | TP12* | 6 |
| | X 3, X 5, X 6 | 2008-2009 | PHI/CR2 | BM-6P6 | TPX4/TPX5 | TPX4/TPX5 | TP12* | 6 |
| | X 5 | 2000-2007 | PHI/CR2 | BM-6P6 | TPX4/TPX5 | TPX4/TPX5 | TP12* | 6 |
| | | 2007-2007 | PHI/CR2 | BM-6P6 | TPX4/TPX5 | TPX4/TPX5 | TP12* | 6 |
| | X 5 W/PROX | 2007-2011 | PHI/CR2 | BM-6RKE | TPX4/TPX5 | TPX4/TPX5 | TP12* | 6 |
| | X 6 W/PROX | 2008-2013 | PHI/CR2 | BM-6RKE | TPX4/TPX5 | TPX4/TPX5 | TP12* | 6 |
| | Z 3 | 1995-2002 | PHI/CR2 | BM-6P6 | TPX4/TPX5 | TPX4/TPX5 | TP12* | 6 |
| | Z 4 | 2003-2011 | PHI/CR2 | BM-5P4 | TPX4/TPX5 | TPX4/TPX5 | TP12* | 5 |
| | | 2003-2011 | PHI/CR2 | BM-6P6 | TPX4/TPX5 | TPX4/TPX5 | TP12* | 6 |
| Z 4 W/PROX | 2008-2013 | PHI/CR2 | BM-6RKE | TPX4/TPX5 | TPX4/TPX5 | TP12* | 6 | |
| Z 4 M COUPE | 2008-2008 | PHI/CR2 | DEALER KEY | | | - | | |
| BUICK® | ALLURE (CANADA) | 2005-2009 | MEG/- | GM-37P | TP05 | TP05 | TP03/TP05** | 4 |
| | | 2010-2012 | PHI/CR2 | OP-11P5 | TPX4/TPX5 | TPX4/TPX5 | TP12GM | 9 |
| | | 2010-2012 | PHI/CR2 | ORIGINAL | | | - | |
| | CASCADA | 2016- | PHI/CR2 | ORIGINAL | | | - | |
| | CENTURY | 1997-1999 | -/- | ORIGINAL | | | - | |
| | | 2000-2005 | -/- | ORIGINAL | | | - | |
| | ENCLAVE | 2007-2018 | PHI/CR2 | GM-37P | TPX4/TPX5 | TPX4/TPX5 | TP12GM | 4 |
| | ENCORE | 2014-2018 | PHI/CR2 | OP-11P5 | TPX4/TPX5 | TPX4/TPX5 | TP12GM | 9 |
| | LACROSSE (CANADA) | 2005-2009 | MEG/- | GM-37P | TP05 | TP05 | TP03/TP05** | 4 |
| | LACROSSE | 2010-2016 | PHI/CR2 | OP-11P5 | TPX4/TPX5 | TPX4/TPX5 | TP12GM | 9 |
| | LE SABRE | 1992-1999 | -/- | ORIGINAL | | | - | |
| | | 2000-2005 | MEG/- | GM-28P | TP05 | TP05 | TP03/TP05** | 4 |
| | LUCERNE | 2006-2011 | PHI/CR2 | GM-37P | TPX4/TPX5 | TPX4/TPX5 | TP12GM | 4 |
| | PARK AVENUE | 1997-2005 | MEG/- | GM-27P | TP05 | TP05 | TP03/TP05** | 4 |
| | | 1997-2005 | MEG/- | GM-43P | TP05 | TP05 | TP03/TP05** | 4 |
| | | 2003-2005 | MEG/- | GM-27P | TP05 | TP05 | TP03/TP05** | 4 |
| | RAINIER | 2003-2007 | MEG/- | GM-28P | TP05 | TP05 | TP03/TP05** | 4 |
| | REGAL W/O PEPS | 2011-2018 | PHI/CR2 | OP-11P5 | TPX4/TPX5 | TPX4/TPX5 | TP12GM | 9 |
| | REGAL W/PEPS | 2011-2018 | PHI/CR2 | DEALER KEY | | | - | |
| | RENDEVOUZ | 2002-2007 | MEG/- | GM-28P | TP05 | TP05 | TP03/TP05** | 4 |
| | RIVIERA | 1992-1994 | -/- | ORIGINAL | | | - | |
| | | 1995-1999 | -/- | ORIGINAL | | | - | |
| ROADMASTER | 1994-1996 | -/- | ORIGINAL | | | - | | |
| TERRAZA | 2005-2006 | MEG/- | GM-27P | TP05 | TP05 | TP03/TP05** | 4 | |
| | 2007-2008 | MEG/- | GM-37P | TP05 | TP05 | TP03/TP05** | 4 | |
| VERANO | 2012-2018 | PHI/CR2 | OP-11P5 | TPX4/TPX5 | TPX4/TPX5 | TP37 | 9 | |
| VERANO W/PEPS | 2012- | PHI/CR2 | DEALER KEY | | | - | | |
| CADILLAC® | ATS | 2013-2014 | PHI/CR2 | DEALER KEY | | | - | |
| | | 2015- | PHI/CR2 | DEALER KEY | | | - | |

| FOR: |  |  |  |  | TRS-5000 EVO | EVO XPERT | Programming TP |  |
|---------------------------------------|---|---|---|---|-----------------|----------------|-------------------|---|
| | BLS | 2005-2010 | PHI/CR2 | DEALER KEY | | | - | |
| | BROUGHAM | 1993-1996 | -/- | ORIGINAL | | | - | |
| | CATERA | 1997-1999 | PHI/CR | OP-SP | TP05 | TP05 | TP01/TP05** | 9 |
| | | 2000-2001 | PHI/CR | OP-SP | | | TP09 | 9 |
| | CONCOURS | 1991-1999 | -/- | ORIGINAL | | | - | |
| | CTS | 2002-2003 | MEG/- | GM-28P | TP05 | TP05 | TP03/TP05** | 4 |
| | | 2003-2007 | MEG/CR | GM-28P | TPX8+ | TPX8+ | TP08 | 4 |
| | | 2008-2013 | PHI/CR2 | GM-37P | TPX4/TPX5 | TPX4/TPX5 | TP12GM | 4 |
| | | 2014- | PHI/CR2 | DEALER KEY | | | - | |
| | DEVILLE | 1991-1999 | -/- | ORIGINAL | | | - | |
| | DEVILLE STS | 2000-2005 | MEG/- | GM-28P | TP05 | TP05 | TP03/TP05** | 4 |
| | DTS | 2006-2011 | PHI/CR2 | GM-37P | TPX4/TPX5 | TPX4/TPX5 | TP12GM | 4 |
| | ELDORADO | 1991-2003 | -/- | ORIGINAL | | | - | |
| | ELR | 2014- | PHI/CR2 | DEALER KEY | | | - | |
| | ESCALADE | 2007-2014 | PHI/CR2 | GM-37P | TPX4/TPX5 | TPX4/TPX5 | TP12GM | 4 |
| | | 2015- | PHI/CR2 | DEALER KEY | | | - | |
| | FLEETWOOD | 1993-1996 | -/- | ORIGINAL | | | - | |
| | SEVILLE | 1991-1996 | -/- | ORIGINAL | | | - | |
| | | 1997-1999 | MEG/- | GM-28P | TP05 | TP05 | TP03/TP05** | 4 |
| | | 2000-2005 | MEG/- | GM-28P | TP05 | TP05 | TP03/TP05** | 4 |
| | SRX | 2004-2006 | MEG/CR | GM-37P | TPX8+ | TPX8+ | TP08 | 4 |
| | | 2007-2009 | PHI/CR2 | GM-37P | TPX4/TPX5 | TPX4/TPX5 | TP12GM | 4 |
| | | 2010-2014 | PHI/CR2 | OP-11P5 | TPX4/TPX5 | TPX4/TPX5 | TP12GM | 9 |
| | | 2015- | PHI/CR2 | DEALER KEY | | | - | |
| | STS | 2004-2011 | PHI/CR2 | GM-37P | TPX4/TPX5 | TPX4/TPX5 | TP12GM | 4 |
| | | 2008-2011 | PHI/CR2 | DEALER KEY | | | - | |
| | XLR | 2004-2009 | PHI/CR2 | GM-37P | TPX4/TPX5 | TPX4/TPX5 | TP12GM | 4 |
| | XT5 | 2017- | PHI/CR2 | DEALER KEY | | | - | |
| | XTS | 2013- | PHI/CR2 | DEALER KEY | | | - | |
| CHEVROLET[®] (KR) | ARANOS | 1995- | MEG/- | OP-SP | TP05 | TP05 | TP03/TP05** | 9 |
| | AVEO | 2006-2011 | MEG/CR | DAE-3DP1 | TPM1 | TPM1 | TP08 | 1 |
| | | 2011- | PHI/CR2 | OP-11P1 | TPX4/TPX5 | TPX4/TPX5 | TP12GM | 8 |
| | | 2011- | PHI/CR2 | ORIGINAL | | | - | |
| | CAPTIVA | 2006- | PHI/CR2 | ORIGINAL | | | - | |
| | | 2006- | PHI/CR2 | DAE-4P1 | TPX4/TPX5 | TPX4/TPX5 | TP12GM | 2 |
| | | 2013- | PHI/CR2 | DEALER KEY | | | - | |
| | CIELO | -1998 | MEG/- | OP-SP | TP05 | TP05 | TP03/TP05** | 9 |
| | CRUZE | 2008- | PHI/CR2 | OP-11P1 | TPX4/TPX5 | TPX4/TPX5 | TP12GM | 8 |
| | | 2008-2014 | PHI/CR2 | ORIGINAL | | | - | |
| | | 2011- | PHI/CR2 | DEALER KEY | | | - | |
| | EPICA | 2006-2013 | TEX/CR | DAE-4P1 | TPX2/TPX5/TPX6 | TPX2/TPX5/TPX6 | TP19 | 2 |
| | | 2006-2013 | TEX/CR | ORIGINAL | | | - | |
| | | 2008-2013 | TEX/CR | DAE-4P1 | TPX2/TPX5/TPX6 | TPX2/TPX5/TPX6 | - | 2 |
| | | 2008-2013 | TEX/CR | ORIGINAL | | | - | |
| | ESPERO | 1995-1997 | MEG/- | OP-SP | TP05 | TP05 | TP03/TP05** | 9 |
| | EVANDA | 2003-2006 | TEX/CR | DAE-4P1 | TPX2/TPX5/TPX6 | TPX2/TPX5/TPX6 | TP19 | 2 |
| | | 2003-2006 | TEX/CR | ORIGINAL | | | - | |
| | KALOS | 2002-2006 | MEG/CR | DAE-3DP1 | TPM1 | TPM1 | TP08 | 1 |
| | LACETI | 2002-2004 | MEG/CR | DAE-3DP1 | TPM1 | TPM1 | TP08 | 1 |
| | LACETTI | 2004-2009 | TEX/CR | DAE-3DP1 | TPX2/TPX5/TPX6 | TPX2/TPX5/TPX6 | TP19 | 1 |

AUTOMÓVIL - CAMIONETA





CAR-PICK UP TRUCK





| FOR: |  |  |  |  | TRS-5000 EVO | EVO XPERT | Programming TP |  |
|---|---|---|---|---|-----------------|----------------|-------------------|---|
| | | 2004-2009 | TEX/CR | ORIGINAL | | | - | |
| LANOS | | 1997-2002 | MEG/- | DAE-4DP1 | TP05 | TP05 | TP03/TP05** | 2 |
| | | 2002-2004 | MEG/CR | DAE-4P1 | TPM1 | TPM1 | TP08 | 2 |
| LEGANZA | | 1997-2000 | MEG/- | DAE-4P1 | TP05 | TP05 | TP03/TP05** | 2 |
| | | 2000-2008 | MEG/CR | DAE-4P1 | TPM1 | TPM1 | TP08 | 2 |
| MALIBU | | 2012- | PHI/CR2 | OP-11P1 | TPX4/TPX5 | TPX4/TPX5 | TP12GM | 8 |
| | | 2012- | PHI/CR2 | OP-11P5 | TPX4/TPX5 | TPX4/TPX5 | TP12GM | 9 |
| | | 2012- | PHI/CR2 | ORIGINAL | | | - | |
| MATIZ | | 1998-2000 | MEG/- | DAE-6P | TP05 | TP05 | TP03/TP05** | 2 |
| | | 2001-2005 | MEG/CR | DAE-6P | TPM1 | TPM1 | TP08 | 2 |
| | | 2006- | MEG/CR | DAE-3DP1 | TPM1 | TPM1 | TP08 | 1 |
| NEXIA | | 1995-1997 | MEG/- | OP-SP | TP05 | TP05 | TP03/TP05** | 9 |
| NUBIRA | | 1997-2000 | MEG/- | DAE-3DP1 | TP05 | TP05 | TP03/TP05** | 1 |
| | | 2000-2002 | MEG/CR | DAE-3DP1 | TPM1 | TPM1 | TP08 | 1 |
| | | 2002-2006 | MEG/CR | DAE-6P | TPM1 | TPM1 | TP08 | 2 |
| NUBIRA SW | | 2004-2009 | TEX/CR | DAE-3DP1 | TPX2/TPX5/TPX6 | TPX2/TPX5/TPX6 | TP19 | 1 |
| | | 2004-2009 | TEX/CR | ORIGINAL | | | - | |
| ORLANDO | | 2011- | PHI/CR2 | OP-11P1 | TPX4/TPX5 | TPX4/TPX5 | TP12GM | 8 |
| | | 2011- | PHI/CR2 | ORIGINAL | | | - | |
| SPARK | | 2009-2015 | SOK/CR | DEALER KEY | | | - | |
| | | 2015- | PHI/CR2 | ORIGINAL | | | - | |
| TACUMA | | 2000-2008 | MEG/CR | DAE-3DP1 | TPM1 | TPM1 | TP08 | 1 |
| TRAX | | 2012-2014 | PHI/CR2 | OP-11P1 | TPX4/TPX5 | TPX4/TPX5 | TP12GM | 8 |
| | | 2012- | PHI/CR2 | ORIGINAL | | | - | |
| VOLT | | 2012- | PHI/CR2 | OP-11P1 | TPX4/TPX5 | TPX4/TPX5 | TP12GM | 8 |
| | | 2012- | PHI/CR2 | ORIGINAL | | | - | |
| CHEVROLET® (S.AMERICA) | AGILE | 2009- | PHI/CR2 | OP-11P1 | TPX4/TPX5 | TPX4/TPX5 | TP12GM | 8 |
| | | 2009- | PHI/CR2 | ORIGINAL | | | - | |
| | ASTRA | 1999-2007 | PHI/CR | OP-SP | | | TP09 | 9 |
| | | 2007- | PHI/CR2 | ORIGINAL | | | - | |
| | BLAZER | 2006- | PHI/CR2 | ORIGINAL | | | - | |
| | CAPTIVA | 2008- | PHI/CR2 | ORIGINAL | | | - | |
| | CELTA | 2000- | PHI/CR | OP-SP | | | TP09 | 9 |
| | CORSA | 1995-1998 | PHI/- | OP-DP | TP05 | TP05 | TP01/TP05** | 9 |
| | | 1995-1998 | PHI/- | OP-SP | TP05 | TP05 | TP01/TP05** | 9 |
| | | 1998-1999 | PHI/CR | OP-DP | | | TP09 | 9 |
| | | 1998-1999 | PHI/CR | OP-SP | | | TP09 | 9 |
| | | 1998-1999 | PHI/CR | OP-STL | | | TP09 | 9 |
| | | 2000- | PHI/CR | OP-SP | | | TP09 | 9 |
| | 2000- | PHI/CR | OP-STL2 | | | TP09 | 9 | |
| | CORSA HATCH | 2000- | PHI/CR | OP-SP | | | TP09 | 9 |
| | MERIVA | 2002- | PHI/CR | OP-SP | | | TP09 | 9 |
| | MONTANA | 2003- | PHI/CR | OP-SP | | | TP09 | 9 |
| | OMEGA | 1995-1998 | PHI/- | OP-WHP | TP05 | TP05 | TP01/TP05** | 10 |
| | | 1995-1998 | PHI/- | OP-WYP | TP05 | TP05 | TP01/TP05** | 10 |
| | ONIX | 2012- | PHI/CR2 | OP-11P1 | TPX4/TPX5 | TPX4/TPX5 | TP12GM | 8 |
| | | 2012- | PHI/CR2 | ORIGINAL | | | - | |
| | PRISMA | 2006-2012 | PHI/CR | OP-SP | | | TP09 | 9 |
| 2012- | | PHI/CR2 | OP-11P1 | TPX4/TPX5 | TPX4/TPX5 | TP12GM | 8 | |
| 2012- | | PHI/CR2 | ORIGINAL | | | - | | |

| FOR: |  |  |  |  | TRS-5000 EVO | EVO XPERT | Programming TP |  |
|---------------------------------|---|---|---|---|-----------------|----------------|-------------------|---|
| | S-10 | 2006- 2006- | PHI/CR2 PHI/CR2 | GM-27P ORIGINAL | TPX4/TPX5 | TPX4/TPX5 | TP12GM - | 4 |
| | TRACKER | 1998-2007 | TEX/- | SUZU-10P1 | TPX1/TPX6/TPX5 | TPX1/TPX6/TPX5 | TP07 | 17 |
| | | 2013-2014 | PHI/CR2 | OP-11P1 | TPX4/TPX5 | TPX4/TPX5 | TP12GM | 8 |
| | VECTRA | 2005- | PHI/CR | OP-SP | | | TP09 | 9 |
| | | 2009- | PHI/CR | OP-DTL2 | | | TP09 | 9 |
| | ZAFIRA | 1999-2000 | PHI/- | OP-SP | TP01/TP05 | TP01/TP05 | TP01/TP05** | 9 |
| | | 1999-2000 | PHI/CR | OP-SP | | | TP09 | 9 |
| | | 1999-2000 | PHI/CR | OP-STL | | | TP09 | 9 |
| | | 2001-2005 | PHI/CR | OP-SP | | | TP09 | 9 |
| | | 2006- | PHI/CR2 | ORIGINAL | | | - | |
| CHEVROLET [®] (USA) | AVALANCHE | 2007-2013 | PHI/CR2 | GM-37P | TPX4/TPX5 | TPX4/TPX5 | TP12GM | 4 |
| | AVEO | 2004-2010 | MEG/- | DAE-4DP1 | TP05 | TP05 | TP03/TP05** | 2 |
| | CAMARO | 1991-2002 | -/- | ORIGINAL | | | - | |
| | | 2010-2015 | PHI/CR2 | OP-11P5 | TPX4/TPX5 | TPX4/TPX5 | TP37 | 9 |
| | | 2016- | PHI/CR2 | DEALER KEY | | | - | |
| | CAPRICE (PPV) | 2011-2013 | PHI/CR2 | GM-49DP | TPX4/TPX5 | TPX4/TPX5 | TP12GM | 4 |
| | | 2011-2013 | PHI/CR2 | OP-11P5 | TPX4/TPX5 | TPX4/TPX5 | TP37 | 9 |
| | | 2014-2018 | PHI/CR2 | OP-11P5 | TPX4/TPX5 | TPX4/TPX5 | TP37 | 9 |
| | CAPTIVA SPORT | 2012-2015 | PHI/CR2 | DAE-4DP2 | TPX4/TPX5 | TPX4/TPX5 | TP12GM | 2 |
| | CITY EXPRESS | 2015- | PHI/CR2 | OP-11P5 | TPX4/TPX5 | TPX4/TPX5 | TP12NS | 9 |
| | COBALT | 2006-2010 | PHI/CR2 | GM-37P | TPX4/TPX5 | TPX4/TPX5 | TP12GM | 4 |
| | COLORADO (CAN) | 2008-2012 | MEG/CR | GM-28.P | TPX8+ | TPX8+ | TP08 | 4 |
| | | 2015- | PHI/CR2 | OP-11P5 | TPX4/TPX5 | TPX4/TPX5 | TP37 | 9 |
| | CORVETTE | 1997-1999 | -/- | ORIGINAL | | | - | |
| | | 2000-2004 | -/- | ORIGINAL | | | - | |
| | | 2005-2013 | PHI/CR2 | DEALER KEY | | | - | |
| | CRUZE | 2011-2016 | PHI/CR2 | OP-11P5 | TPX4/TPX5 | TPX4/TPX5 | TP37 | 9 |
| | CRUZE W/PROX | 2011-2016 | PHI/CR2 | DEALER KEY | | | - | |
| | EPICA | 2004-2007 | MEG/- | DAE-4P1 | TP05 | TP05 | TP03/TP05** | 2 |
| | EQUINOX | 2007-2009 | PHI/CR2 | GM-37P | TPX4/TPX5 | TPX4/TPX5 | TP12GM | 4 |
| | | 2010- | PHI/CR2 | OP-11P5 | TPX4/TPX5 | TPX4/TPX5 | TP37 | 9 |
| | EXPRESS | 1995-1998 | -/- | ORIGINAL | | | - | |
| | | 1999-2007 | -/- | ORIGINAL | | | - | |
| | | 2008-2014 | PHI/CR2 | GM-37P | TPX4/TPX5 | TPX4/TPX5 | TP12GM | 4 |
| | | 2015- | PHI/CR2 | OP-11P5 | TPX4/TPX5 | TPX4/TPX5 | TP37 | 9 |
| | HHR | 2006-2011 | PHI/CR2 | GM-37P | TPX4/TPX5 | TPX4/TPX5 | TP12GM | 4 |
| | EXPRESS | 1995-1996 | -/- | ORIGINAL | | | - | |
| | IMPALA | 2006-2013 | PHI/CR2 | GM-37P | TPX4/TPX5 | TPX4/TPX5 | TP12GM | 4 |
| | | 2014- | PHI/CR2 | OP-11P5 | TPX4/TPX5 | TPX4/TPX5 | TP37 | 9 |
| | IMPALA W/PROX | 2014- | PHI/CR2 | DEALER KEY | | | - | |
| | LUMINA | 1995-2001 | -/- | ORIGINAL | | | - | |
| | MALIBU | 2004-2013 | PHI/CR2 | GM-37P | TPX4/TPX5 | TPX4/TPX5 | TP12GM | 4 |
| 2014-2016 | | PHI/CR2 | OP-11P5 | TPX4/TPX5 | TPX4/TPX5 | TP37 | 9 | |
| MALIBU W/PROX | 2016- | PHI/CR2 | DEALER KEY | | | - | | |
| MONTECARLO | 1995-1999 | -/- | ORIGINAL | | | - | | |
| | 2006-2007 | PHI/CR2 | GM-37P | TPX4/TPX5 | TPX4/TPX5 | TP12GM | 4 | |
| ORLANDO | 2012-2014 | PHI/CR2 | OP-11P5 | TPX4/TPX5 | TPX4/TPX5 | - | 9 | |
| SILVERADO | 2007-2013 | PHI/CR2 | GM-37P | TPX4/TPX5 | TPX4/TPX5 | TP12GM | 4 | |
| | 2014- | PHI/CR2 | OP-11P5 | TPX4/TPX5 | TPX4/TPX5 | TP37 | 9 | |

AUTOMÓVIL - CAMIONETA





CAR-PICK UP TRUCK





| FOR: |  |  |  |  | TRS-5000 EVO | EVO XPERT | Programming TP |  |
|-----------|---|---|---|---|-----------------|----------------|-------------------|---|
| | SONIC | 2012- | PHI/CR2 | OP-11P5 | TPX4/TPX5 | TPX4/TPX5 | TP37 | 9 |
| | SPARK | 2013-2015 | MEG/CR | DAE-3P4 | TPX8+ | TPX8+ | TP08 | 2 |
| | | 2015 - | MEG/CR | DAE-3P5 | | | TP32CS | 2 |
| | SSR | 2003-2006 | -/- | ORIGINAL | | | - | |
| | SUBURBAN | 2007-2014 | PHI/CR2 | GM-37P | TPX4/TPX5 | TPX4/TPX5 | TP12GM | 4 |
| | | 2015- | PHI/CR2 | OP-11P5 | TPX4/TPX5 | TPX4/TPX5 | TP37 | 9 |
| | SUBURBAN W/PROX | 2015- | PHI/CR2 | DEALER KEY | | | - | |
| | TAHOE | 2007-2014 | PHI/CR2 | GM-37P | TPX4/TPX5 | TPX4/TPX5 | TP12GM | 4 |
| | | 2015- | PHI/CR2 | OP-11P5 | TPX4/TPX5 | TPX4/TPX5 | TP37 | 9 |
| | TAHOE W/PROX | 2015- | PHI/CR2 | DEALER KEY | | | - | |
| | TRAILBLAZER | 2006- | PHI/CR2 | GM-37P | TPX4/TPX5 | TPX4/TPX5 | TP12GM | 4 |
| | TRAVERSE | 2009-2016 | PHI/CR2 | GM-37P | TPX4/TPX5 | TPX4/TPX5 | TP12GM | 4 |
| | TRAX (CAN) | 2013-2018 | PHI/CR2 | OP-11P5 | TPX4/TPX5 | TPX4/TPX5 | TP37 | 9 |
| | UPLANDER | 2005-2005 | MEG/- | GM-37P | TP05 | TP05 | TP03/TP05** | 4 |
| | | 2005-2006 | MEG/- | GM-27P | TP05 | TP05 | TP03/TP05** | 4 |
| | | 2007-2009 | MEG/- | GM-28P | TP05 | TP05 | TP03/TP05** | 4 |
| | VENTURE VAN | 1999-2002 | MEG/- | GM-27P | TP05 | TP05 | TP03/TP05** | 4 |
| 2003-2005 | | MEG/- | GM-27P | TP05 | TP05 | TP03/TP05** | 4 | |
| VIVANT | 2004-2007 | MEG/- | DAE-4DP1 | TP05 | TP05 | TP03/TP05** | 2 | |
| VOLT | 2011-2015 | PHI/CR2 | OP-11P5 | TPX4/TPX5 | TPX4/TPX5 | - | 9 | |
| | | PHI/CR2 | ORIGINAL | | | - | | |
| CHRYSLER® | 200 | 2011-2014 | PHI/CR2 | CHR-15P | TPX4/TPX5 | TPX4/TPX5 | TP12CH | 1 |
| | 300/300C | 2005-2007 | PHI/CR2 | CHR-15P | TPX4/TPX5 | TPX4/TPX5 | TP12CH | 1 |
| | | 2008-2015 | PHI/CR2 | CHR-15P1 | TPX4/TPX5 | TPX4/TPX5 | - | 1 |
| | | 2012-2015 | PHI/CR2 | DEALER KEY | | | - | |
| | 300M | 1999-2004 | TEX/CR | CHR-15P | TPX2/TPX5/TPX6 | TPX2/TPX5/TPX6 | TP21 | 1 |
| | ASPEN | 2007-2009 | PHI/CR2 | CHR-15P | TPX4/TPX5 | TPX4/TPX5 | TP12CH | 1 |
| | CIRRUS | 1999-2000 | TEX/CR | CHR-15P | TPX2/TPX5/TPX6 | TPX2/TPX5/TPX6 | TP21 | 1 |
| | | 2001-2002 | TEX/CR | CHR-15P | TPX2/TPX5/TPX6 | TPX2/TPX5/TPX6 | TP21 | 1 |
| | CIRRUS SEDAN | 1998-2004 | TEX/CR | CHR-15P | TPX2/TPX5/TPX6 | TPX2/TPX5/TPX6 | TP21 | 1 |
| | CONCORDE | 1998-2004 | TEX/CR | CHR-15P | TPX2/TPX5/TPX6 | TPX2/TPX5/TPX6 | TP21 | 1 |
| | CROSSFIRE | 2003-2008 | -/- | ME-7P | | | - | 8 |
| | LHS | 1999-2001 | TEX/CR | CHR-15P | TPX2/TPX5/TPX6 | TPX2/TPX5/TPX6 | TP21 | 1 |
| | NEON | 1995-2005 | TEX/CR | CHR-15P | TPX2/TPX5/TPX6 | TPX2/TPX5/TPX6 | TP21 | 1 |
| | NEW YORKER | 1998-2001 | TEX/CR | CHR-15P | TPX2/TPX5/TPX6 | TPX2/TPX5/TPX6 | TP21 | 1 |
| | PACIFICA | 2004-2008 | PHI/CR2 | CHR-15P | TPX4/TPX5 | TPX4/TPX5 | TP12CH | 1 |
| | | 2017- | PHI/CR2 | DEALER KEY | | | - | |
| | PT CRUISER | 2001-2005 | TEX/CR | CHR-15P | TPX2/TPX5/TPX6 | TPX2/TPX5/TPX6 | TP21 | 1 |
| | | 2006-2011 | PHI/CR2 | CHR-15P | TPX4/TPX5 | TPX4/TPX5 | TP12CH | 1 |
| | SEBRING CONVERT | 1998-2006 | TEX/CR | CHR-15P | TPX2/TPX5/TPX6 | TPX2/TPX5/TPX6 | TP21 | 1 |
| | | 2007-2011 | PHI/CR2 | CHR-15P | TPX4/TPX5 | TPX4/TPX5 | TP12CH | 1 |
| | SEBRING COUPE | 2001-2001 | TEX/CR | CHR-15P | TPX2/TPX5/TPX6 | TPX2/TPX5/TPX6 | TP19 | 1 |
| | | 2001-2006 | TEX/CR | CHR-19P | TPX2/TPX5/TPX6 | TPX2/TPX5/TPX6 | TP26 | 1 |
| | SEBRING SEDAN | 1998-2006 | TEX/CR | CHR-15P | TPX2/TPX5/TPX6 | TPX2/TPX5/TPX6 | TP21 | 1 |
| | | 2007-2011 | PHI/CR2 | CHR-15P | TPX4/TPX5 | TPX4/TPX5 | TP12CH | 1 |
| | STRATUS | 1998-2006 | TEX/CR | CHR-15P | TPX2/TPX5/TPX6 | TPX2/TPX5/TPX6 | TP21 | 1 |
| | STRATUS 2 DR. | 2001-2005 | TEX/CR | CHR-15P | TPX2/TPX5/TPX6 | TPX2/TPX5/TPX6 | TP19 | 1 |
| | TOWN & COUNTRY | 2001-2003 | TEX/CR | CHR-15P | TPX2/TPX5/TPX6 | TPX2/TPX5/TPX6 | TP21 | 1 |
| | | 2004-2007 | PHI/CR2 | CHR-15P | TPX4/TPX5 | TPX4/TPX5 | TP12CH | 1 |
| | | 2008-2016 | PHI/CR2 | CHR-15P1 | TPX4/TPX5 | TPX4/TPX5 | TP12CH | 1 |

| FOR: |  |  |  |  | TRS-5000 EVO | EVO XPERT | Programming TP |  |
|----------------------|---|---|---|---|-----------------|----------------|-------------------|---|
| | VISION | 1998- | TEX/CR | CHR-15P | TPX2/TPX5/TPX6 | TPX2/TPX5/TPX6 | TP21 | 1 |
| | VOYAGER VAN | 1998-2003 | TEX/CR | CHR-15P | TPX2/TPX5/TPX6 | TPX2/TPX5/TPX6 | TP21 | 1 |
| | | 2004-2007 | PHI/CR2 | CHR-15P | TPX4/TPX5 | TPX4/TPX5 | TP12CH | 1 |
| | | 2008-2015 | PHI/CR2 | CHR-15P1 | TPX4/TPX5 | TPX4/TPX5 | - | 1 |
| | YPSILON | 2011- | PHI/CR2 | FI-16P | TPX4/TPX5 | TPX4/TPX5 | - | 20 |
| CITROEN [®] | BERLINGO | 1998-2001 | PHI/- | SIX-3P3 | TP01/TP05 | TP01/TP05 | TP01/TP05** | 16 |
| | | 2001-2002 | PHI/CR2 | SIX-3P3 | TPX4/TPX5 | TPX4/TPX5 | TP12 | 16 |
| | | 2002- | PHI/CR2 | CIT-1P | TPX4/TPX5 | TPX4/TPX5 | TP12 | 21 |
| | C1 | 2004-2014 | TEX/CR | CIT-1P | TPX2/TPX5/TPX6 | TPX2/TPX5/TPX6 | TP35 | 21 |
| | | 2004-2014 | TEX/CR | ORIGINAL | | | - | |
| | | 2014- | TEX/AES | KI-7P | | TPAE1 | - | 13 |
| | | 2014- | TEX/AES | ORIGINAL | | | - | |
| | C2 | 2003-2010 | PHI/CR2 | CIT-1P | TPX4/TPX5 | TPX4/TPX5 | TP12 | 21 |
| | C3 | 2002-2016 | PHI/CR2 | CIT-1P | TPX4/TPX5 | TPX4/TPX5 | TP12 | 21 |
| | | 2016- | PHI/CR3 | ORIGINAL | | | - | |
| | C3 PICASSO | 2008-2017 | PHI/CR2 | CIT-1P | TPX4/TPX5 | TPX4/TPX5 | TP12 | 21 |
| | C3 PLURIEL | 2003-2010 | PHI/CR2 | CIT-1P | TPX4/TPX5 | TPX4/TPX5 | TP12 | 21 |
| | C4 | 2005- | PHI/CR2 | CIT-1P | TPX4/TPX5 | TPX4/TPX5 | TP12 | 21 |
| | C4 AIRCROSS | 2012-2017 | PHI/CR2 | MIT-8DP1 | TPX4/TPX5 | TPX4/TPX5 | TP12 | 14 |
| | | 2012-2017 | PHI/CR2 | DEALER KEY | | | - | |
| | C4 PICASSO | 2006-2013 | PHI/CR2 | HU-HCAP | TPX4/TPX5 | TPX4/TPX5 | TP12 | 8 |
| | | 2013- | PHI/CR2 | DEALER KEY | | | - | |
| | C5 | 2001-2004 | PHI/CR2 | SIX-3P3 | TPX4/TPX5 | TPX4/TPX5 | TP12 | 16 |
| | | 2004-2008 | PHI/CR2 | CIT-1P | TPX4/TPX5 | TPX4/TPX5 | TP12 | 21 |
| | | 2008-2017 | PHI/CR2 | HU-HCAP | TPX4/TPX5 | TPX4/TPX5 | TP12 | 8 |
| | C6 | 2005-2012 | PHI/CR2 | CIT-1P | TPX4/TPX5 | TPX4/TPX5 | TP12 | 21 |
| | C8 | 2002-2014 | PHI/CR2 | HU-HCAP | TPX4/TPX5 | TPX4/TPX5 | TP12 | 8 |
| | CACTUS | 2014- | PHI/CR2 | HU-HCAP | TPX4/TPX5 | TPX4/TPX5 | TP12 | 8 |
| | C-CROSSER | 2007-2012 | PHI/CR2 | MIT-8DP2 | TPX4/TPX5 | TPX4/TPX5 | TP12 | 14 |
| | | 2007-2012 | PHI/CR2 | ORIGINAL | | | - | |
| | C-ELYSEE | 2013-2016 | PHI/CR2 | HU-HCAP | TPX4/TPX5 | TPX4/TPX5 | TP12 | 8 |
| | C-ZERO | 2011- | PHI/CR2 | MIT-8DP2 | TPX4/TPX5 | TPX4/TPX5 | TP12 | 14 |
| | | 2011- | PHI/CR2 | ORIGINAL | | | - | |
| | DISPATCH | 1998-2001 | PHI/- | SIX-3P3 | TP01/TP05 | TP01/TP05 | TP01/TP05** | 16 |
| | | 2002-2006 | PHI/CR2 | SIX-3P3 | TPX4/TPX5 | TPX4/TPX5 | TP12 | 16 |
| | | 2007-2016 | PHI/CR2 | HU-HCAP | TPX4/TPX5 | TPX4/TPX5 | TP12 | 8 |
| | | 2016- | PHI/CR3 | ORIGINAL | | | - | |
| | DS3 | 2009- | PHI/CR2 | CIT-1P | TPX4/TPX5 | TPX4/TPX5 | TP12 | 21 |
| DS4 | 2011- | PHI/CR2 | CIT-1P | TPX4/TPX5 | TPX4/TPX5 | TP12 | 21 | |
| | 2011- | PHI/CR2 | DEALER KEY | | | - | | |
| DS5 | 2012- | PHI/CR2 | DEALER KEY | | | - | | |
| EVASION | 1998-2002 | PHI/- | SIX-3P3 | TP01/TP05 | TP01/TP05 | TP01/TP05** | 16 | |
| JUMPER | 1996-2001 | MEG/- | FI-11P5 | TP05 | TP05 | TP03/TP05** | 19 | |
| | 2002-2010 | MEG/CR | FI-16P | TPX8+ | TPX8+ | TP08 | 20 | |
| | 2002-2010 | MEG/CR | ORIGINAL | | | - | | |
| | 2009- | PHI/CR2 | FI-16P | TPX4/TPX5 | TPX4/TPX5 | TP12 | 20 | |
| | 2009- | PHI/CR2 | ORIGINAL | | | - | | |
| JUMPY | 1998-2001 | PHI/- | SIX-3P3 | TP01/TP05 | TP01/TP05 | TP01/TP05** | 16 | |
| | 2002-2006 | PHI/CR2 | SIX-3P3 | TPX4/TPX5 | TPX4/TPX5 | TP12 | 16 | |
| | 2007-2016 | PHI/CR2 | HU-HCAP | TPX4/TPX5 | TPX4/TPX5 | TP12 | 8 | |

AUTOMÓVIL - CAMIONETA





CAR-PICK UP TRUCK







| FOR: |  |  |  |  | TRS-5000 EVO | EVO XPERT | Programming TP |  |
|------------------|---|---|---|---|-----------------|----------------|-------------------|---|
| | NEMO | 2016- | PHI/CR3 | ORIGINAL | | | - | |
| | | 2008- | PHI/CR2 | FI-16P | TPX4/TPX5 | TPX4/TPX5 | TP12 | 20 |
| | RELAY | 2008- | PHI/CR2 | ORIGINAL | | | - | |
| | | 1996-2001 | MEG/- | FI-11P5 | TP05 | TP05 | TP03/TP05** | 19 |
| | | 2002-2010 | MEG/CR | FI-16P | TPX8+ | TPX8+ | TP08 | 20 |
| | | 2002-2010 | MEG/CR | ORIGINAL | | | - | |
| | | 2009- | PHI/CR2 | FI-16P | TPX4/TPX5 | TPX4/TPX5 | TP12 | 20 |
| | SAXO | 2009- | PHI/CR2 | ORIGINAL | | | - | |
| | | 1998-2000 | PHI/- | SIX-3P3 | TP01/TP05 | TP01/TP05 | TP01/TP05** | 16 |
| | SPACE TOURER | 2000-2003 | PHI/CR2 | SIX-3P3 | TPX4/TPX5 | TPX4/TPX5 | TP12 | 16 |
| | | 2016- | PHI/CR3 | DEALER KEY | | | - | |
| | SYNERGIE | 1998-2002 | PHI/- | SIX-3P3 | TP01/TP05 | TP01/TP05 | TP01/TP05** | 16 |
| | XANTIA | 1998-1999 | PHI/- | SIX-3P3 | TP01/TP05 | TP01/TP05 | TP01/TP05** | 16 |
| | | 1999-2001 | MEG/CR | SIX-3P3 | TPX8+ | TPX8+ | TP08 | 16 |
| XSARA | 1998-2001 | PHI/- | SIX-3P3 | TP01/TP05 | TP01/TP05 | TP01/TP05** | 16 | |
| | 2001-2006 | PHI/CR2 | SIX-3P3 | TPX4/TPX5 | TPX4/TPX5 | TP12 | 16 | |
| XSARA PICASSO | 2000-2006 | PHI/CR2 | SIX-3P3 | TPX4/TPX5 | TPX4/TPX5 | TP12 | 16 | |
| DAEWOO® (USA) | LANOS | 2000-2003 | MEG/- | DAE-4DP1 | TP05 | TP05 | TP03/TP05** | 2 |
| | | 2004-2004 | MEG/- | DAE-4DP1 | | | - | 2 |
| | LEGANZA | 2000-2004 | MEG/- | DAE-4P1 | TP05 | TP05 | TP03/TP05** | 2 |
| | | 2005-2005 | PHI/CR2 | DAE-4DP2 | TPX4/TPX5 | TPX4/TPX5 | TP12 | 2 |
| | NUBIRA | 1998-2002 | MEG/- | DAE-3DP1 | TP05 | TP05 | TP03/TP05** | 1 |
| 2004-2004 | | MEG/- | DAE-3DP1 | | | - | 1 | |
| DAIHATSU® | BE-GO | 2006- | TEX/CR | DAI-1P1 | TPX2/TPX5/TPX6 | TPX2/TPX5/TPX6 | TP30 | 3 |
| | | 2006- | TEX/CR | ORIGINAL | | | - | |
| | BOON | 2005- | TEX/CR | DAI-1P1 | TPX2/TPX5/TPX6 | TPX2/TPX5/TPX6 | TP30 | 3 |
| | | 2005- | TEX/CR | ORIGINAL | | | - | |
| | CHARADE | 1998-2004 | TEX/- | DAI-1P1 | TPX1/TPX6/TPX5 | TPX1/TPX6/TPX5 | TP07 | 3 |
| | | 2011- | TEX/CR | TOYO-19P | TPX2/TPX5/TPX6 | TPX2/TPX5/TPX6 | TP35 | 19 |
| | | 2011- | TEX/CR | ORIGINAL | | | - | |
| | COO | 2005- | TEX/CR | DAI-1P1 | TPX2/TPX5/TPX6 | TPX2/TPX5/TPX6 | TP30 | 3 |
| | | 2005- | TEX/CR | ORIGINAL | | | - | |
| | COOPEN | 2002- | TEX/- | TOYO-20DP | TPX1/TPX6/TPX5 | TPX1/TPX6/TPX5 | TP07 | 19 |
| | CUORE | 1998-2006 | TEX/- | DAI-1P1 | TPX1/TPX6/TPX5 | TPX1/TPX6/TPX5 | TP07 | 3 |
| | | 1998-2006 | TEX/- | DAI-3P1 | TPX1/TPX6/TPX5 | TPX1/TPX6/TPX5 | TP07 | 3 |
| | | 2007- | TEX/CR | DAI-1P1 | TPX2/TPX5/TPX6 | TPX2/TPX5/TPX6 | TP30 | 3 |
| | | 2007- | TEX/CR | ORIGINAL | | | - | |
| | | 1995-1998 | TEX/- | DAI-1P1 | TPX1/TPX6/TPX5 | TPX1/TPX6/TPX5 | TP07 | 3 |
| | MATERIA | 2006- | TEX/CR | DAI-1P1 | TPX2/TPX5/TPX6 | TPX2/TPX5/TPX6 | TP30 | 3 |
| | | 2006- | TEX/CR | ORIGINAL | | | - | |
| | MOVE | 1997-2002 | TEX/- | DAI-3P1 | TPX1/TPX6/TPX5 | TPX1/TPX6/TPX5 | TP07 | 3 |
| | SIRION | 1998-2004 | TEX/- | DAI-1P1 | TPX1/TPX6/TPX5 | TPX1/TPX6/TPX5 | TP07 | 3 |
| | | 2005- | TEX/CR | DAI-1P1 | TPX2/TPX5/TPX6 | TPX2/TPX5/TPX6 | TP30 | 3 |
| 2005- | | TEX/CR | ORIGINAL | | | - | | |
| STORIA | 2005- | TEX/CR | DAI-1P1 | TPX2/TPX5/TPX6 | TPX2/TPX5/TPX6 | TP30 | 3 | |
| | 2005- | TEX/CR | ORIGINAL | | | - | | |
| TERIOS | 1997-2005 | TEX/- | DAI-1P1 | TPX1/TPX6/TPX5 | TPX1/TPX6/TPX5 | TP07 | 3 | |
| | 2006- | TEX/CR | DAI-1P1 | TPX2/TPX5/TPX6 | TPX2/TPX5/TPX6 | TP30 | 3 | |
| | 2006- | TEX/CR | ORIGINAL | | | - | | |

| FOR: |  |  |  |  | TRS-5000 EVO | EVO XPERT | Programming TP |  |
|-----------------|---|---|---|---|-----------------|----------------|-------------------|---|
| | TREVIS | 2007- | TEX/CR | DAI-1P1 | TPX2/TPX5/TPX6 | TPX2/TPX5/TPX6 | TP30 | 3 |
| | | 2007- | TEX/CR | ORIGINAL | | | - | |
| DODGE® | YRV | 2000-2005 | TEX/- | DAI-1P1 | TPX1/TPX6/TPX5 | TPX1/TPX6/TPX5 | TP07 | 3 |
| | AVENGER | 2008-2014 | PHI/CR2 | CHR-15P | TPX4/TPX5 | TPX4/TPX5 | TP12CH | 1 |
| | CALIBER | 2007-2012 | PHI/CR2 | CHR-15P | TPX4/TPX5 | TPX4/TPX5 | TP12CH | 1 |
| | CARAVAN | 2001-2003 | TEX/CR | CHR-15P | TPX2/TPX5/TPX6 | TPX2/TPX5/TPX6 | TP21 | 1 |
| | | 2004-2007 | PHI/CR2 | CHR-15P | TPX4/TPX5 | TPX4/TPX5 | TP12CH | 1 |
| | | 2008-2018 | PHI/CR2 | CHR-15P1 | TPX4/TPX5 | TPX4/TPX5 | TP12CH | 1 |
| | CHALLENGER | 2008-2018 | PHI/CR2 | CHR-15P1 | TPX4/TPX5 | TPX4/TPX5 | TP12CH | 1 |
| | | 2012- | PHI/CR2 | DEALER KEY | | | - | |
| | CHARGER | 2005-2008 | PHI/CR2 | CHR-15P | TPX4/TPX5 | TPX4/TPX5 | TP12CH | 1 |
| | | 2009-2018 | PHI/CR2 | CHR-15P1 | TPX4/TPX5 | TPX4/TPX5 | TP12CH | 1 |
| | | 2012- | PHI/CR2 | DEALER KEY | | | - | |
| | DAKOTA | 2001-2004 | TEX/CR | CHR-15P | TPX2/TPX5/TPX6 | TPX2/TPX5/TPX6 | TP21 | 1 |
| | | 2005-2012 | PHI/CR2 | CHR-15P | TPX4/TPX5 | TPX4/TPX5 | TP12CH | 1 |
| | DART | 2013- | PHI/CR2 | CHR-15P1 | TPX4/TPX5 | TPX4/TPX5 | TP12CH | 1 |
| | DART W/PROX | 2013- | PHI/CR2 | DEALER KEY | | | - | |
| | DURANGO | 2001-2006 | TEX/CR | CHR-15P | TPX2/TPX5/TPX6 | TPX2/TPX5/TPX6 | TP21 | 1 |
| | | 2005-2008 | PHI/CR2 | CHR-15P | TPX4/TPX5 | TPX4/TPX5 | TP12CH | 1 |
| | | 2011-2015 | PHI/CR2 | CHR-15P1 | TPX4/TPX5 | TPX4/TPX5 | TP12CH | 1 |
| | | 2014- | PHI/CR2 | DEALER KEY | | | - | |
| | INTREPID | 1998-2004 | TEX/CR | CHR-15P | TPX2/TPX5/TPX6 | TPX2/TPX5/TPX6 | TP21 | 1 |
| | JOURNEY | 2009-2015 | PHI/CR2 | CHR-15P1 | TPX4/TPX5 | TPX4/TPX5 | TP12CH | 1 |
| | | 2012-2015 | PHI/CR2 | DEALER KEY | | | - | |
| | MAGNUM | 2005-2007 | PHI/CR2 | CHR-15P | TPX4/TPX5 | TPX4/TPX5 | TP12CH | 1 |
| | | 2008-2009 | PHI/CR2 | CHR-15P1 | TPX4/TPX5 | TPX4/TPX5 | TP12CH | 1 |
| | NEON | 2000-2005 | TEX/CR | CHR-15P | TPX2/TPX5/TPX6 | TPX2/TPX5/TPX6 | TP21 | 1 |
| | NITRO | 2007-2012 | PHI/CR2 | CHR-15P | TPX4/TPX5 | TPX4/TPX5 | TP12CH | 1 |
| | PROMASTER | 2014- | PHI/CR2 | FI-16P | TPX4/TPX5 | TPX4/TPX5 | - | 20 |
| | | 2014- | PHI/CR2 | ORIGINAL | | | - | |
| | RAM 1500/2500/3500 | 2002-2005 | TEX/CR | CHR-15P | TPX2/TPX5/TPX6 | TPX2/TPX5/TPX6 | TP21 | 1 |
| | RAM 1500 | 2009-2015 | PHI/CR2 | CHR-15P1 | TPX4/TPX5 | TPX4/TPX5 | - | 1 |
| | RAM 1500 SPORT | 2006-2008 | PHI/CR2 | CHR-15P | TPX4/TPX5 | TPX4/TPX5 | TP12CH | 1 |
| | RAM 1500 P/U | 2013-2015 | PHI/CR2 | DEALER KEY | | | - | |
| | RAM 2500/3500 SPORT | 2006-2010 | PHI/CR2 | CHR-15P | TPX4/TPX5 | TPX4/TPX5 | TP12CH | 1 |
| | SPRINTER | 2003-2006 | TEM/- | ME-HMP1 | TP05 | TP05 | TP04/TP05** | 21 |
| | | 2007-2013 | PHI/CR2 | ME-7P1 | TPX4/TPX5 | TPX4/TPX5 | - | 8 |
| | | 2007-2013 | PHI/CR2 | ORIGINAL | | | - | |
| | STRATUS (CANADA) | 2001-2003 | TEX/CR | CHR-15P | TPX2/TPX5/TPX6 | TPX2/TPX5/TPX6 | TP21 | 1 |
| | STRATUS COUPE | 2001-2001 | TEX/CR | CHR-15P | TPX2/TPX5/TPX6 | TPX2/TPX5/TPX6 | TP19 | 1 |
| | | 2002-2005 | TEX/CR | CHR-19P | TPX2/TPX5/TPX6 | TPX2/TPX5/TPX6 | TP26 | 1 |
| | STRATUS SEDAN | 1999-2006 | TEX/CR | CHR-15P | TPX2/TPX5/TPX6 | TPX2/TPX5/TPX6 | TP21 | 1 |
| EAGLE® | VISION | 1998- | TEX/CR | CHR-15P | TPX2/TPX5/TPX6 | TPX2/TPX5/TPX6 | TP21 | 1 |
| FERRARI® | 458 | 2009-2011 | MEG/CR | FI-16P | TPX8+ | TPX8+ | TP08 | 20 |
| | 612 SCAGLIETTI | 2004-2011 | MEG/CR | FI-16P | TPX8+ | TPX8+ | TP08 | 20 |
| | CALIFORNIA | 2008-2011 | MEG/CR | FI-16P | TPX8+ | TPX8+ | TP08 | 20 |
| FIAT® | 124 | 2016- | PHI/CR3 | DEALER KEY | | | - | |
| | 500 | 2007- | PHI/CR2 | FI-16P | TPX4/TPX5 | TPX4/TPX5 | TP12 | 20 |
| | | 2007- | PHI/CR2 | ORIGINAL | | | - | |
| | 500L | 2012- | PHI/CR2 | FI-16P | TPX4/TPX5 | TPX4/TPX5 | TP12 | 20 |

AUTOMÓVIL - CAMIONETA





CAR-PICK UP TRUCK





| FOR: |  |  |  |  | TRS-5000 EVO | EVO XPERT | Programming TP |  |
|--------------|---|---|---|---|-----------------|--------------|-------------------|---|
| | | 2012- | PHI/CR2 | ORIGINAL | | | - | |
| 500X | | 2014- | MEG/AES | ORIGINAL | | | - | |
| | | 2014- | PHI/CR3 | DEALER KEY | | | - | |
| ALBEA | | 2002-2012 | MEG/CR | FI-16P | TPX8+ | TPX8+ | TP08 | 20 |
| | | 2002-2012 | MEG/CR | ORIGINAL | | | - | |
| BARCETTA | | 1995-2002 | MEG/- | FI-13P2 | TP05 | TP05 | TP03/TP05** | 19 |
| | | 1995-2002 | MEG/- | FI-13P8 | TP05 | TP05 | TP03/TP05** | 20 |
| BRAVA | | 1995-1997 | MEG/- | FI-13P5 | TP05 | TP05 | TP03/TP05** | 20 |
| | | 1995-1997 | MEG/- | FI-13P8 | TP05 | TP05 | TP03/TP05** | 20 |
| | | 1997-2001 | MEG/- | FI-13P7 | TP05 | TP05 | TP03/TP05** | 20 |
| | | 1997-2001 | MEG/- | FI-13P8 | TP05 | TP05 | TP03/TP05** | 20 |
| | | 1997-2001 | TEM/- | FI-13P7 | TP05 | TP05 | TP04/TP05** | 20 |
| | | 1997-2001 | TEM/- | FI-13P8 | TP05 | TP05 | TP04/TP05** | 20 |
| BRAVO | | 1995-1997 | MEG/- | FI-13P5 | TP05 | TP05 | TP03/TP05** | 20 |
| | | 1995-1997 | MEG/- | FI-13P8 | TP05 | TP05 | TP03/TP05** | 20 |
| | | 1997-2001 | MEG/- | FI-13P7 | TP05 | TP05 | TP03/TP05** | 20 |
| | | 1997-2001 | MEG/- | FI-13P8 | TP05 | TP05 | TP03/TP05** | 20 |
| | | 1997-2001 | TEM/- | FI-13P7 | TP05 | TP05 | TP04/TP05** | 20 |
| | | 1997-2001 | TEM/- | FI-13P8 | TP05 | TP05 | TP04/TP05** | 20 |
| | | 2007-2015 | MEG/CR | FI-16P | TPX8+ | TPX8+ | TP08 | 20 |
| | | 2007-2015 | MEG/CR | ORIGINAL | | | - | |
| | | 2007-2015 | PHI/CR2 | FI-16P | TPX4/TPX5 | TPX4/TPX5 | TP12** | 20 |
| | | 2007-2015 | PHI/CR2 | ORIGINAL | | | - | |
| CINQUECENTO | | 1995-1996 | MEG/- | FI-11P5 | TP05 | TP05 | TP03/TP05** | 19 |
| | | 1997-1998 | MEG/- | FI-13P5 | TP05 | TP05 | TP03/TP05** | 20 |
| | | 1997-1998 | MEG/- | FI-13P8 | TP05 | TP05 | TP03/TP05** | 20 |
| COUPE | | 1995-2000 | PHI/- | FI-13P2 | TP01 | TP01 | TP01/TP05** | 19 |
| | | 1995-2000 | PHI/- | FI-13P8 | TP01 | TP01 | TP01/TP05** | 20 |
| CROMA | | 1995-1998 | PHI/- | FI-11P5 | TP01 | TP01 | TP01/TP05** | 19 |
| | | 2005-2010 | PHI/CR2 | ORIGINAL | | | - | |
| DOBLO | | 2000-2006 | MEG/CR | FI-16P | TPX8+ | TPX8+ | TP08 | 20 |
| | | 2000-2006 | MEG/CR | ORIGINAL | | | - | |
| | | 2006- | PHI/CR2 | FI-16P | TPX4/TPX5 | TPX4/TPX5 | TP12** | 20 |
| | | 2006- | PHI/CR2 | ORIGINAL | | | - | |
| DUCATO | | 1996-2001 | MEG/- | FI-11P5 | TP05 | TP05 | TP03/TP05** | 19 |
| | | 2002-2010 | MEG/CR | FI-16P | TPX8+ | TPX8+ | TP08 | 20 |
| | | 2002-2010 | MEG/CR | ORIGINAL | | | - | |
| | | 2009- | PHI/CR2 | FI-16P | TPX4/TPX5 | TPX4/TPX5 | TP12** | 20 |
| | | 2009- | PHI/CR2 | ORIGINAL | | | - | |
| FIORINO | | 1995-2002 | TEM/- | FI-11P5 | TP05 | TP05 | TP04/TP05** | 19 |
| | | 2007- | PHI/CR2 | FI-16P | TPX4/TPX5 | TPX4/TPX5 | - | 20 |
| | | 2007- | PHI/CR2 | ORIGINAL | | | - | |
| FREEMONT | | 2011-2015 | PHI/CR2 | DEALER KEY | | | - | |
| FULLBACK | | 2016- | PHI/CR3 | DEALER KEY | | | - | |
| | | 2016- | PHI/CR3 | ORIGINAL | | | - | |
| GRAND SIENA | | 2012- | PHI/CR2 | FI-16P | TPX4/TPX5 | TPX4/TPX5 | TP12** | 20 |
| GRANDE PUNTO | | 2005-2012 | PHI/CR2 | FI-16P | TPX4/TPX5 | TPX4/TPX5 | TP12** | 20 |
| | | 2005-2012 | PHI/CR2 | ORIGINAL | | | - | |
| IDEA | | 2003-2009 | MEG/CR | FI-16P | TPX8+ | TPX8+ | TP08 | 20 |
| | | 2003-2009 | MEG/CR | ORIGINAL | | | - | |

| FOR: |  |  |  |  | TRS-5000 EVO | EVO XPERT | Programming TP |  |  |
|------------|---|---|---|---|-----------------|--------------|-------------------|---|---|
| | | 2009-2012 | PHI/CR2 | FI-16P | TPX4/TPX5 | TPX4/TPX5 | TP12** | 20 | |
| | | 2009-2012 | PHI/CR2 | ORIGINAL | | | - | | |
| LINEA | | 2007-2015 | MEG/CR | FI-16P | TPX8+ | TPX8+ | TP08 | 20 | |
| | | 2007-2015 | MEG/CR | ORIGINAL | | | - | | |
| MAREA | | 1996-2002 | TEM/- | FI-13P7 | TP05 | TP05 | TP04/TP05** | 20 | |
| | | 1996-2002 | TEM/- | FI-13P8 | TP05 | TP05 | TP04/TP05** | 20 | |
| MARENGO | | 1996-2001 | MEG/- | FI-13P5 | TP05 | TP05 | TP03/TP05** | 20 | |
| | | 1996-2001 | MEG/- | FI-13P8 | TP05 | TP05 | TP03/TP05** | 20 | |
| MILLE | | 2005-2013 | MEG/CR | FI-16P | TPX8+ | TPX8+ | TP08 | 20 | |
| | | 2005-2013 | MEG/CR | ORIGINAL | | | - | | |
| MULTIPLA | | 1998-2010 | MEG/CR | FI-16P15 | TPX8+ | TPX8+ | TP08 | 20 | |
| | | 1998-2010 | MEG/CR | ORIGINAL | | | - | | |
| PANDA | | 1995-2002 | MEG/- | FI-11P5 | TP05 | TP05 | TP03/TP05** | 19 | |
| | | 2002-2011 | PHI/CR2 | FI-16P | TPX4/TPX5 | TPX4/TPX5 | TP12** | 20 | |
| | | 2002-2011 | PHI/CR2 | ORIGINAL | | | - | | |
| | | 2011- | PHI/CR2 | FI-16P | TPX4/TPX5 | TPX4/TPX5 | TP12** | 20 | |
| | | 2011- | PHI/CR2 | ORIGINAL | | | - | | |
| PUNTO | | 1995-1999 | MEG/- | FI-13P2 | TP05 | TP05 | TP03/TP05** | 19 | |
| | | 1995-1999 | MEG/- | FI-13P8 | TP05 | TP05 | TP03/TP05** | 20 | |
| | | 1999-2005 | MEG/CR | FI-13P7 | TPX8+ | TPX8+ | TP08 | 20 | |
| | | 1999-2005 | MEG/CR | FI-13P8 | TPX8+ | TPX8+ | TP08 | 20 | |
| | | 1999-2005 | MEG/CR | ORIGINAL | | | - | | |
| | | 2006-2011 | MEG/CR | FI-16P | TPX8+ | TPX8+ | TP08 | 20 | |
| | | 2006-2011 | MEG/CR | ORIGINAL | | | - | | |
| | | 2012- | PHI/CR2 | FI-16P | TPX4/TPX5 | TPX4/TPX5 | TP12** | 20 | |
| | | 2012- | PHI/CR2 | ORIGINAL | | | - | | |
| PUNTO EVO | | 2009-2012 | PHI/CR2 | FI-16P | TPX4/TPX5 | TPX4/TPX5 | TP12** | 20 | |
| | | 2009-2012 | PHI/CR2 | ORIGINAL | | | - | | |
| QUBO | | 2008- | PHI/CR2 | FI-16P | TPX4/TPX5 | TPX4/TPX5 | TP12** | 20 | |
| | | 2008- | PHI/CR2 | ORIGINAL | | | - | | |
| SCUDO | | 1996-2001 | PHI/- | SIX-3P3 | TP01 | TP01 | TP01/TP05** | 16 | |
| | | 2002-2006 | PHI/CR2 | SIX-3P3 | TPX4/TPX5 | TPX4/TPX5 | TP12** | 16 | |
| | | 2007-2016 | PHI/CR2 | HU-HCAP | TPX4/TPX5 | TPX4/TPX5 | TP12** | 8 | |
| | | 2007-2016 | PHI/CR2 | HU-HCAC3 | | | - | 20 | |
| SEDICI | | 2006-2014 | PHI/CR2 | SUZU-14P2 | TPX4/TPX5 | TPX4/TPX5 | TP12** | 17 | |
| SEDICI (D) | | 2006-2014 | PHI/CR | SUZU-14P2 | | | TPH1** | 17 | |
| SEICENTO | | 1997-2000 | MEG/- | FI-13P5 | TP05 | TP05 | TP03/TP05** | 20 | |
| | | 1997-2000 | MEG/- | FI-13P8 | TP05 | TP05 | TP03/TP05** | 20 | |
| | | 2000-2010 | MEG/CR | FI-13P5 | TPX8+ | TPX8+ | TP08 | 20 | |
| | | 2000-2010 | MEG/CR | ORIGINAL | | | - | | |
| SIENA | | 2002-2011 | MEG/CR | FI-13P8 | TPX8+ | TPX8+ | TP08 | 20 | |
| | | 2002-2011 | MEG/CR | ORIGINAL | | | - | | |
| STILO | | 2001-2008 | MEG/CR | FI-16P | TPX8+ | TPX8+ | TP08 | 20 | |
| | | 2001-2008 | MEG/CR | ORIGINAL | | | - | | |
| TALENTO | | 2016- | PHI/CR3 | ORIGINAL | | | - | | |
| TEMPRA | | 1995-1996 | MEG/- | FI-13P5 | TP05 | TP05 | TP03/TP05** | 20 | |
| | | 1995-1996 | MEG/- | FI-13P8 | TP05 | TP05 | TP03/TP05** | 20 | |
| TIPO | | 2015- | MEG/AES | ORIGINAL | | | - | | |
| ULYSSE | | 1996-2002 | PHI/- | SIX-3P3 | TP01 | TP01 | TP01/TP05** | 16 | |
| | | 2002-2011 | PHI/CR2 | HU-HCAP | TPX4/TPX5 | TPX4/TPX5 | TP12** | 8 | |

AUTOMÓVIL - CAMIONETA





CAR-PICK UP TRUCK





| FOR: |  |  |  |  | TRS-5000 EVO | EVO XPERT | Programming TP |  |
|----------------------|---|---|---|---|-----------------|----------------|-------------------|---|
| | | 2006-2011 | PHI/CR2 | HU-HCAC3 | | | - | 20 |
| | VIAGGIO | 2013- | PHI/CR2 | FI-16P | TPX4/TPX5 | TPX4/TPX5 | - | 20 |
| | | 2013- | PHI/CR2 | ORIGINAL | | | - | |
| FIAT® (S.AMERICA) | DOBLO | 2006- | MEG/CR | FI-16P | TPX8+ | TPX8+ | TP08 | 20 |
| | | 2006- | MEG/CR | ORIGINAL | | | - | |
| | IDEA | 2009- | MEG/CR | FI-16P | TPX8+ | TPX8+ | TP08 | 20 |
| | | 2009- | MEG/CR | ORIGINAL | | | - | |
| | PALIO (BRASIL) | 1996-2001 | TEM/- | FI-13P7 | TP05 | TP05 | TP04/TP05** | 20 |
| | | 1996-2001 | TEM/- | FI-13P8 | TP05 | TP05 | TP04/TP05** | 20 |
| | | 2002-2010 | MEG/CR | FI-13P8 | TPX8+ | TPX8+ | TP08 | 20 |
| | | 2002-2010 | MEG/CR | ORIGINAL | | | - | |
| STILO | 2011- | PHI/CR2 | FI-16P | TPX4/TPX5 | TPX4/TPX5 | - | 20 | |
| | 2009-2011 | MEG/CR | FI-16P | TPX8+ | TPX8+ | TP08 | 20 | |
| | 2009-2011 | MEG/CR | ORIGINAL | | | - | | |
| FIAT® (USA) | 500 | 2012- | PHI/CR2 | FI-16P | TPX4/TPX5 | TPX4/TPX5 | TP12** | 20 |
| | 500 CABRIO | 2012- | PHI/CR2 | FI-16P | TPX4/TPX5 | TPX4/TPX5 | TP12** | 20 |
| FORD® | B-MAX | 2012-2018 | TEX/DST80 | FO-24P | TPX7 | TPX7 | TP33 | 6 |
| | | 2012-2018 | TEX/DST80 | FO-24TL2 | TPX7 | TPX7 | TP33 | 7 |
| | C-MAX | 2010-2015 | TEX/DST80 | FO-24P | TPX7 | TPX7 | TP33 | 6 |
| | | 2015-2019 | TEX/DST80 | FO-24P | TPX7 | TPX7 | TP33 | 6 |
| | COUGAR | 1997-2002 | -/- | FO-6TL | | | - | 6 |
| | | 1997-2002 | TEX/- | FO-6P | TPX1/TPX6/TPX5 | TPX1/TPX6/TPX5 | TP02 | 6 |
| | COURIER KOMBI | 1998-2002 | -/- | FO-6TL | | | - | 6 |
| | | 1998-2002 | TEX/- | FO-6P | TPX1/TPX6/TPX5 | TPX1/TPX6/TPX5 | TP02 | 6 |
| | ECO SPORT | 2013- | TEX/DST80 | FO-24P | TPX7 | TPX7 | TP33 | 6 |
| | | 2013- | TEX/DST80 | FO-24TL2 | TPX7 | TPX7 | TP33 | 7 |
| | | 2018- | PHI/CR3 | DEALER KEY | | | - | |
| | EDGE | 2011-2013 | TEX/DST80 | FO-24P | TPX7 | TPX7 | TP33 | 6 |
| | | 2014- | PHI/CR3 | DEALER KEY | | | - | |
| | ESCORT | 1995-2000 | TEX/- | FO-6P | TPX1/TPX6/TPX5 | TPX1/TPX6/TPX5 | TP02 | 6 |
| | EXPLORER | 1997-2001 | TEX/- | FO-15DP | TPX1/TPX6/TPX5 | TPX1/TPX6/TPX5 | TP02 | |
| | FIESTA | 1995-2002 | TEX/- | FO-6P | TPX1/TPX6/TPX5 | TPX1/TPX6/TPX5 | TP02 | 6 |
| | | 2003-2008 | TEX/CR | FO-6P | TPX2/TPX5/TPX6 | TPX2/TPX5/TPX6 | TP20 | 6 |
| | | 2003-2008 | TEX/CR | FO-24TL2 | TPX2/TPX5/TPX6 | TPX2/TPX5/TPX6 | TP20 | 7 |
| | | 2008-2012 | TEX/CR | FO-24P | TPX2/TPX5/TPX6 | TPX2/TPX5/TPX6 | TP20 | 6 |
| | | 2011-2017 | TEX/DST80 | FO-24P | TPX7 | TPX7 | TP33 | 6 |
| | | 2017- | PHI/CR3 | FO-24P | | | - | 6 |
| | | 2017- | PHI/CR3 | ORIGINAL | | | - | |
| | 2017- | PHI/CR3 | DEALER KEY | | | - | | |
| FOCUS | 1998-2004 | -/- | FO-6TL | | | - | 6 | |
| | 1998-2004 | TEX/CR | FO-6P | TPX2/TPX5/TPX6 | TPX2/TPX5/TPX6 | TP06 | 6 | |
| | 2004-2010 | TEX/CR | FO-24P | TPX2/TPX5/TPX6 | TPX2/TPX5/TPX6 | TP20 | 6 | |
| | 2004-2010 | TEX/CR | FO-24TL2 | TPX2/TPX5/TPX6 | TPX2/TPX5/TPX6 | TP20 | 7 | |
| | 2004-2010 | TEX/CR | DEALER KEY | | | - | | |
| | 2011-2018 | TEX/DST80 | FO-24P | TPX7 | TPX7 | TP33 | 6 | |
| FOCUS C-MAX | 2003-2010 | TEX/CR | FO-24P | TPX2/TPX5/TPX6 | TPX2/TPX5/TPX6 | TP20 | 6 | |
| | 2003-2010 | TEX/CR | FO-24TL2 | TPX2/TPX5/TPX6 | TPX2/TPX5/TPX6 | TP20 | 7 | |
| | 2011- | TEX/DST80 | FO-24P | TPX7 | TPX7 | TP33 | 6 | |
| FUSION | 2002-2012 | TEX/CR | FO-6P | TPX2/TPX5/TPX6 | TPX2/TPX5/TPX6 | TP20 | 6 | |

| FOR: |  |  |  |  | TRS-5000 EVO | EVO XPERT | Programming TP |  |
|-----------------|---|---|---|---|-----------------|--------------|-------------------|---|
| GALAXY | 1995-1998 | PHI/- | HU-HAAP | TP01/TP05 | TP01/TP05 | TP01/TP05** | 7 | |
| | 1995-1998 | PHI/- | HU-HAATL | TP01/TP05 | TP01/TP05 | TP01/TP05** | 7 | |
| | 1998-2000 | PHI/CR | HU-HAAP1 | TPH1 | TPH1 | TP10 | 7 | |
| | 2000-2006 | PHI/CR | HU-HAAP1 | TPH1 | TPH1 | TP14 | 7 | |
| | 2006-2010 | TEX/CR | FO-24P | TPX2/TPX5/TPX6 | TPX2/TPX5/TPX6 | TP20 | 6 | |
| | 2006-2010 | TEX/CR | FO-24TL2 | TPX2/TPX5/TPX6 | TPX2/TPX5/TPX6 | TP20 | 7 | |
| | 2010-2014 | TEX/DST80 | FO-24P | TPX7 | TPX7 | TP33 | 6 | |
| | 2010-2014 | TEX/DST80 | FO-24TL2 | TPX7 | TPX7 | TP33 | 7 | |
| | 2015- | PHI/CR3 | DEALER KEY | | | - | | |
| GRANADA | 1995-2001 | TEX/- | FO-6P | TPX1/TPX6/TPX5 | TPX1/TPX6/TPX5 | TP02 | 6 | |
| KA | 1996-2002 | TEX/- | FO-6P | TPX1/TPX6/TPX5 | TPX1/TPX6/TPX5 | TP02 | 6 | |
| | 1996-2002 | -/- | FO-6TL | | | - | 6 | |
| | 2002-2008 | TEX/CR | FO-6P | TPX2/TPX5/TPX6 | TPX2/TPX5/TPX6 | TP06 | 6 | |
| | 2008-2016 | PHI/CR2 | FI-16P | TPX4/TPX5 | TPX4/TPX5 | - | 20 | |
| | 2008-2016 | PHI/CR2 | ORIGINAL | | | - | | |
| KA+ | 2016- | PHI/CR3 | ORIGINAL | | | - | | |
| | 2016- | PHI/CR3 | DEALER KEY | | | - | | |
| KUGA | 2008-2012 | TEX/CR | FO-24P | TPX2/TPX5/TPX6 | TPX2/TPX5/TPX6 | TP20 | 6 | |
| | 2008-2012 | TEX/CR | DEALER KEY | | | - | | |
| | 2011-2016 | TEX/DST80 | FO-24P | TPX7 | TPX7 | TP33 | 6 | |
| MAVERICK | 1995-1997 | PHI/- | DAT-6P2 | TP01/TP05 | TP01/TP05 | TP01/TP05** | 15 | |
| MONDEO | 1995-2001 | TEX/- | FO-6P | TPX1/TPX6/TPX5 | TPX1/TPX6/TPX5 | TP02 | 6 | |
| | 1995-2007 | -/- | FO-6TL | | | - | 6 | |
| | 2001-2007 | TEX/CR | FO-6P | TPX2/TPX5/TPX6 | TPX2/TPX5/TPX6 | TP06 | 6 | |
| | 2007-2010 | TEX/CR | FO-24P | TPX2/TPX5/TPX6 | TPX2/TPX5/TPX6 | TP20 | 6 | |
| | 2007-2010 | TEX/DST80 | FO-24TL2 | TPX2/TPX5/TPX6 | TPX2/TPX5/TPX6 | TP20 | 7 | |
| | 2011-2014 | TEX/DST80 | FO-24P | TPX7 | TPX7 | TP33 | 6 | |
| | 2011-2014 | TEX/DST80 | FO-24TL2 | TPX7 | TPX7 | TP33 | 7 | |
| | 2014- | PHI/CR3 | FO-24P | | | - | 6 | |
| 2014- | PHI/CR3 | DEALER KEY | | | - | | | |
| MUSTANG | 2015- | PHI/CR3 | DEALER KEY | | | - | | |
| ORION | 1995-2001 | TEX/- | FO-6P | TPX1/TPX6/TPX5 | TPX1/TPX6/TPX5 | TP02 | 6 | |
| PROBE | 1996-1997 | TEM/- | MAZ-10DP | TP05 | TP05 | TP04/TP05** | 13 | |
| PUMA | 1998-2002 | -/- | FO-6TL | | | - | 6 | |
| | 1998-2002 | TEX/- | FO-6P | TPX1/TPX6/TPX5 | TPX1/TPX6/TPX5 | TP02 | 6 | |
| RANGER | 2006-2012 | TEM/CR | MAZ-10DP | TPT1 | TPT1 | TP17 | 13 | |
| | 2006-2012 | TEM/CR | ORIGINAL | | | - | | |
| | 2012- | TEX/DST80 | FO-24P | TPX7 | TPX7 | TP33 | 6 | |
| SCORPIO | 1995-1998 | -/- | FO-6TL | | | - | 6 | |
| | 1995-1998 | TEX/- | FO-6P | TPX1/TPX6/TPX5 | TPX1/TPX6/TPX5 | TP02 | 6 | |
| S-MAX | 2006-2010 | TEX/CR | FO-24P | TPX2/TPX5/TPX6 | TPX2/TPX5/TPX6 | TP20 | 6 | |
| MONDEO | 2006-2010 | TEX/CR | FO-24TL2 | TPX2/TPX5/TPX6 | TPX2/TPX5/TPX6 | TP20 | 7 | |
| S-MAX | 2006-2010 | TEX/CR | DEALER KEY | | | - | | |
| | 2010-2015 | TEX/DST80 | FO-24P | TPX7 | TPX7 | TP33 | 6 | |
| | 2010-2015 | TEX/DST80 | FO-24TL2 | TPX7 | TPX7 | TP33 | 7 | |
| | 2015- | PHI/CR3 | FO-24P | | | - | 6 | |
| | 2015- | PHI/CR3 | DEALER KEY | | | - | | |
| TOURNEO CONNECT | 2002-2008 | TEX/CR | FO-6P | TPX2/TPX5/TPX6 | TPX2/TPX5/TPX6 | TP06 | 6 | |
| | 2009-2013 | TEX/CR | FO-6P | TPX2/TPX5/TPX6 | TPX2/TPX5/TPX6 | TP20 | 6 | |
| | 2013- | TEX/DST80 | FO-24P | TPX7 | TPX7 | TP33 | 6 | |

AUTOMÓVIL - CAMIONETA





CAR-PICK UP TRUCK





| FOR: |  |  |  |  | TRS-5000 EVO | EVO XPERT | Programming TP |  | |
|---------------------|---|---|---|---|-----------------|----------------|-------------------|---|------|
| | TOURNEO COURIER | 2012- | TEX/DST80 | FO-24P | TPX7 | TPX7 | TP33 | 6 | |
| | TOURNEO CUSTOM | 2013- | TEX/DST80 | FO-24P | TPX7 | TPX7 | TP33 | 6 | |
| | TRANSIT | 1995-1997 | -/- | | FO-6TL | | | - | 6 |
| | | 1995-2000 | TEX/- | | FO-6P | TPX1/TPX6/TPX5 | TPX1/TPX6/TPX5 | TP02 | 6 |
| | | 2000-2006 | TEX/CR | | FO-6P | TPX2/TPX5/TPX6 | TPX2/TPX5/TPX6 | TP06 | 6 |
| | | 2007-2013 | TEX/CR | | FO-6P | TPX2/TPX5/TPX6 | TPX2/TPX5/TPX6 | TP20 | 6 |
| | | 2013- | TEX/DST80 | | FO-24P | TPX7 | TPX7 | TP33 | 6 |
| | TRANSIT CONNECT | 2002-2008 | TEX/CR | | FO-6P | TPX2/TPX5/TPX6 | TPX2/TPX5/TPX6 | TP06 | 6 |
| | | 2009-2013 | TEX/CR | | FO-6P | TPX2/TPX5/TPX6 | TPX2/TPX5/TPX6 | TP20 | 6 |
| | | 2013- | TEX/DST80 | | FO-24P | TPX7 | TPX7 | TP33 | 6 |
| | TRANSIT COURIER | 2012- | TEX/DST80 | | FO-24P | TPX7 | TPX7 | TP33 | 6 |
| | TRANSIT CUSTOM | 2013- | TEX/DST80 | | FO-24P | TPX7 | TPX7 | TP33 | 6 |
| | WINDSTAR | 1997-2001 | TEX/- | | FO-6P | TPX1/TPX6/TPX5 | TPX1/TPX6/TPX5 | TP02 | 6 |
| | FORD® (AUSTRALIA) | 121 | 1996-2001 | TEX/- | | FO-6P | TPX1/TPX6/TPX5 | TPX1/TPX6/TPX5 | TP02 |
| B-SERIES | | 1999-2001 | TEX/- | | FO-15DP | TPX1/TPX6/TPX5 | TPX1/TPX6/TPX5 | TP02 | 3 |
| | | 2001-2004 | TEX/CR | | ORIGINAL | | | - | |
| ESCAPE | | 2001-2004 | TEX/CR | | FO-15DP | TPX2/TPX5/TPX6 | TPX2/TPX5/TPX6 | TP06 | 3 |
| | | 2005-2008 | TEX/CR | | FO-15DP | TPX2/TPX5/TPX6 | TPX2/TPX5/TPX6 | TP20 | 6 |
| | | 2009-2013 | TEX/CR | | ORIGINAL | | | - | |
| EVEREST | | 2015- | PHI/CR3 | | ORIGINAL | | | - | |
| EXPLORER | | 1998-2000 | TEX/- | | FO-15DP | TPX1/TPX6/TPX5 | TPX1/TPX6/TPX5 | TP02 | 6 |
| | | 2001-2003 | TEX/CR | | FO-15DP | TPX2/TPX5/TPX6 | TPX2/TPX5/TPX6 | TP06 | 6 |
| | | 2004- | TEX/CR | | FO-15DP | TPX2/TPX5/TPX6 | TPX2/TPX5/TPX6 | TP20 | 6 |
| EXPLORER SPORT TRAC | | 1998-2001 | TEX/- | | FO-15DP | TPX1/TPX6/TPX5 | TPX1/TPX6/TPX5 | TP02 | 6 |
| | | 2002-2005 | TEX/CR | | FO-15DP | TPX2/TPX5/TPX6 | TPX2/TPX5/TPX6 | TP06 | 3 |
| FALCON BA | | 2002-2005 | TEX/CR | | FO-6P | TPX2/TPX5/TPX6 | TPX2/TPX5/TPX6 | TP06 | 6 |
| FALCON BF | | 2005 | TEX/DST80 | | FO-24P | | | TP33 | 6 |
| | | 2005- | TEX/CR | | FO-24P | TPX2/TPX5/TPX6 | TPX2/TPX5/TPX6 | - | 6 |
| | | 2005- | TEX/CR2 | | FO-24P | | | TP33 | 6 |
| FALCON FG | | 2008- | TEX/CR | | FO-24P | TPX2/TPX5/TPX6 | TPX2/TPX5/TPX6 | TP20 | 6 |
| | | 2011- | TEX/DST80 | | FO-24P | TPX7 | TPX7 | TP33 | 6 |
| FIESTA | | 2009-2012 | TEX/CR | | FO-24P | TPX2/TPX5/TPX6 | TPX2/TPX5/TPX6 | TP20 | 6 |
| | | 2013- | TEX/DST80 | | FO-24P | TPX7 | TPX7 | TP33 | 6 |
| FOCUS | | 1998-2004 | TEX/CR | | FO-15DP | TPX2/TPX5/TPX6 | TPX2/TPX5/TPX6 | TP06 | 3 |
| | | 2005-2011 | TEX/CR | | FO-24P | TPX2/TPX5/TPX6 | TPX2/TPX5/TPX6 | TP20 | 6 |
| | | 2011-2016 | TEX/DST80 | | FO-24P | TPX7 | TPX7 | TP33 | 6 |
| KUGA | | 2012-2016 | TEX/DST80 | | FO-24P | TPX7 | TPX7 | TP33 | 6 |
| MONDEO | | 2010-2015 | TEX/DST80 | | FO-24P | TPX7 | TPX7 | TP33 | 6 |
| | | 2015- | PHI/CR3 | | ORIGINAL | | | - | |
| RANGER | | 2011-2015 | TEX/DST80 | | FO-24P | TPX7 | TPX7 | TP33 | 6 |
| | | 2015- | PHI/CR3 | | ORIGINAL | | | - | |
| TAURUS | | 2000-2004 | TEX/CR | | FO-15DP | TPX2/TPX5/TPX6 | TPX2/TPX5/TPX6 | TP19 | 3 |
| | | 2004- | TEX/CR | | FO-15DP | TPX2/TPX5/TPX6 | TPX2/TPX5/TPX6 | TP20 | 6 |
| TAURUS LX/SHO | | 1996-2000 | TEX/- | | FO-15DP | TPX1/TPX6/TPX5 | TPX1/TPX6/TPX5 | TP02 | 6 |
| | | 2000- | TEX/CR | | FO-15DP | TPX2/TPX5/TPX6 | TPX2/TPX5/TPX6 | TP06 | 3 |
| TERRITORY | 2004-2005 | TEX/CR | | FO-6P | TPX2/TPX5/TPX6 | TPX2/TPX5/TPX6 | TP06 | 6 | |
| | 2005-2011 | TEX/CR | | FO-24P | | | - | 6 | |
| TRIBUTE | 2001-2003 | TEX/CR | | FO-15DP | TPX2/TPX5/TPX6 | TPX2/TPX5/TPX6 | TP06 | 3 | |

| FOR: |  |  |  |  | TRS-5000 EVO | EVO XPERT | Programming TP |  |
|---|---|---|---|---|-----------------|----------------|-------------------|---|
| FORD[®] (MERCOSUR) | C-MAX | 2004-2007 | TEX/CR | FO-TXP | TPX2/TPX5/TPX6 | TPX2/TPX5/TPX6 | TP06 | 3 |
| | COURIER | 1998-2002 | TEX/- | FO-6P | TPX1/TPX6/TPX5 | TPX1/TPX6/TPX5 | TP02 | 6 |
| | ECO SPORT | 2003-2012 | TEX/CR | FO-TXP | TPX2/TPX5/TPX6 | TPX2/TPX5/TPX6 | TP06 | 3 |
| | | 2012- | TEX/DST80 | FO-24P | TPX7 | TPX7 | TP33 | 6 |
| | | 2012- | TEX/DST80 | ORIGINAL | | | - | |
| | ESCORT | 1998-2002 | TEX/- | FO-6P | TPX1/TPX6/TPX5 | TPX1/TPX6/TPX5 | TP02 | 6 |
| | EXPLORER | 1998-2003 | TEX/- | FO-15DP | TPX1/TPX6/TPX5 | TPX1/TPX6/TPX5 | TP02 | 6 |
| | F-100 | 2000-2005 | TEX/- | FO-15DP | TPX1/TPX6/TPX5 | TPX1/TPX6/TPX5 | TP02 | 6 |
| | FIESTA | 2003- | TEX/CR | FO-TXP | TPX2/TPX5/TPX6 | TPX2/TPX5/TPX6 | TP06 | 3 |
| | FIESTA MAX | 2005- | TEX/CR | FO-TXP | TPX2/TPX5/TPX6 | TPX2/TPX5/TPX6 | TP06 | 3 |
| | FOCUS | 1998-2007 | TEX/CR | FO-6P | TPX2/TPX5/TPX6 | TPX2/TPX5/TPX6 | TP06 | 6 |
| | FOCUS C-MAX | 2004-2007 | TEX/CR | FO-TXP | TPX2/TPX5/TPX6 | TPX2/TPX5/TPX6 | TP06 | 3 |
| | KA | 1998-2002 | TEX/- | FO-6P | TPX1/TPX6/TPX5 | TPX1/TPX6/TPX5 | TP02 | 6 |
| | | 2003-2011 | TEX/CR | FO-6P | TPX2/TPX5/TPX6 | TPX2/TPX5/TPX6 | TP06 | 6 |
| | MONDEO | 2006-2007 | TEX/CR | FO-6P | TPX2/TPX5/TPX6 | TPX2/TPX5/TPX6 | TP06 | 6 |
| | | 2007- | TEX/CR | FO-24P | TPX2/TPX5/TPX6 | TPX2/TPX5/TPX6 | TP20 | 6 |
| RANGER | 1998-2003 | TEX/- | FO-6P | TPX1/TPX6/TPX5 | TPX1/TPX6/TPX5 | TP02 | 6 | |
| | 2004- | TEX/CR | FO-15DP | TPX2/TPX5/TPX6 | TPX2/TPX5/TPX6 | TP20 | 3 | |
| | 2004- | TEX/CR | FO-30DP | TPX2/TPX5/TPX6 | TPX2/TPX5/TPX6 | TP20 | 3 | |
| FORD[®] (SUDAFRIKA) | COURIER | 1998-2002 | TEX/- | FO-6P | TPX1/TPX6/TPX5 | TPX1/TPX6/TPX5 | TP02 | 6 |
| | ECO SPORT | 2003-2007 | TEX/CR | FO-TXP | TPX2/TPX5/TPX6 | TPX2/TPX5/TPX6 | TP06 | 3 |
| | ESCORT | 1998-2002 | TEX/- | FO-6P | TPX1/TPX6/TPX5 | TPX1/TPX6/TPX5 | TP02 | 6 |
| | EXPLORER | 1998-2003 | TEX/- | FO-15DP | TPX1/TPX6/TPX5 | TPX1/TPX6/TPX5 | TP02 | 3 |
| | | 2004- | TEX/CR | FO-30DP | TPX2/TPX5/TPX6 | TPX2/TPX5/TPX6 | TP20 | 3 |
| | F-100 | 2000-2005 | TEX/- | FO-15DP | TPX1/TPX6/TPX5 | TPX1/TPX6/TPX5 | TP02 | 6 |
| | FIESTA | 2003- | TEX/CR | FO-TXP | TPX2/TPX5/TPX6 | TPX2/TPX5/TPX6 | TP06 | 3 |
| | FIESTA MAX | 2005- | TEX/CR | FO-TXP | TPX2/TPX5/TPX6 | TPX2/TPX5/TPX6 | TP06 | 3 |
| | FOCUS | 1998-2007 | TEX/CR | FO-TXP | TPX2/TPX5/TPX6 | TPX2/TPX5/TPX6 | TP06 | 3 |
| | FOCUS C-MAX | 2004-2007 | TEX/CR | FO-TXP | TPX2/TPX5/TPX6 | TPX2/TPX5/TPX6 | TP06 | 3 |
| | KA | 1998-2002 | TEX/- | FO-6P | TPX1/TPX6/TPX5 | TPX1/TPX6/TPX5 | TP02 | 6 |
| | MONDEO | 2006-2007 | TEX/CR | FO-6P | TPX2/TPX5/TPX6 | TPX2/TPX5/TPX6 | TP06 | 6 |
| | | 2007- | TEX/CR | FO-24P | TPX2/TPX5/TPX6 | TPX2/TPX5/TPX6 | TP20 | 6 |
| | RANGER | 1998-2003 | TEX/- | FO-15DP | TPX1/TPX6/TPX5 | TPX1/TPX6/TPX5 | TP02 | 3 |
| | | 2004- | TEX/CR | FO-15DP | TPX2/TPX5/TPX6 | TPX2/TPX5/TPX6 | TP20 | 3 |
| | | 2004- | TEX/CR | FO-30DP | TPX2/TPX5/TPX6 | TPX2/TPX5/TPX6 | TP20 | 3 |
| FORD[®] (USA) | C-MAX | 2013- | TEX/DST80 | FO-24P | TPX7 | TPX7 | TP33 | 6 |
| | | 2013- | TEX/DST80 | DEALER KEY | | | - | |
| | CONTOUR V6 | 1997-2000 | TEX/- | FO-16P | TPX1/TPX6/TPX5 | TPX1/TPX6/TPX5 | TP02 | 3 |
| | CROWN VICTORIA | 1998-2002 | TEX/- | FO-15DCP | TPX1/TPX6/TPX5 | TPX1/TPX6/TPX5 | TP02 | 3 |
| | | 2003-2012 | TEX/CR | FO-30DP | TPX2/TPX5/TPX6 | TPX2/TPX5/TPX6 | TP20 | 3 |
| | EDGE | 2007-2011 | TEX/CR | FO-30DP | TPX2/TPX5/TPX6 | TPX2/TPX5/TPX6 | TP20 | 3 |
| | | 2010-2015 | TEX/DST80 | DEALER KEY | | | - | |
| | | 2011-2013 | TEX/DST80 | FO-24P | TPX7 | TPX7 | TP33 | 6 |
| | | 2011-2015 | TEX/DST80 | FO-30DP | TPX7 | TPX7 | TP33 | 3 |
| | ESCAPE | 2016- | PHI/CR3 | DEALER KEY | | | - | |
| | | 2001-2004 | TEX/CR | FO-15DCP | TPX2/TPX5/TPX6 | TPX2/TPX5/TPX6 | TP06 | 3 |
| 2005-2012 | | TEX/CR | FO-30DP | TPX2/TPX5/TPX6 | TPX2/TPX5/TPX6 | TP20 | 3 | |
| | 2012- | TEX/DST80 | FO-24P | TPX7 | TPX7 | TP33 | 6 | |

AUTOMÓVIL - CAMIONETA





CAR-PICK UP TRUCK

| FOR: |  |  |  |  | TRS-5000 EVO | EVO XPERT | Programming TP |  |
|---------------------|---|---|---|---|-----------------|----------------|-------------------|---|
| | | 2013- | PHI/CR3 | DEALER KEY | | | - | |
| E-SERIES | | 2008-2012 | TEX/CR | FO-30DP | TPX2/TPX5/TPX6 | TPX2/TPX5/TPX6 | TP20 | 3 |
| | | 2013- | TEX/DST80 | FO-30DP | TPX7 | TPX7 | TP33 | 3 |
| EXCURSION | | 2000-2006 | TEX/- | FO-15DCP | TPX1/TPX6/TPX5 | TPX1/TPX6/TPX5 | TP02 | 3 |
| EXPEDITION | | 1997-2002 | TEX/- | FO-15DCP | TPX1/TPX6/TPX5 | TPX1/TPX6/TPX5 | TP02 | 3 |
| | | 2003-2010 | TEX/CR | FO-30DP | TPX2/TPX5/TPX6 | TPX2/TPX5/TPX6 | TP20 | 3 |
| | | 2011-2017 | TEX/DST80 | FO-30DP | TPX7 | TPX7 | TP33 | 3 |
| | | 2018- | PHI/CR3 | FO-24.P2 | | | TP39 | 3 |
| | | 2018- | PHI/CR3 | ORIGINAL | | | - | |
| EXPLORER | | 1998-2001 | TEX/- | FO-15DCP | TPX1/TPX6/TPX5 | TPX1/TPX6/TPX5 | TP02 | 3 |
| | | 2001-2003 | TEX/CR | FO-30DP | TPX2/TPX5/TPX6 | TPX2/TPX5/TPX6 | TP06 | 3 |
| | | 2004-2010 | TEX/CR | FO-30DP | TPX2/TPX5/TPX6 | TPX2/TPX5/TPX6 | TP20 | 3 |
| | | 2010-2015 | TEX/DST80 | DEALER KEY | | | - | |
| | | 2011-2013 | -/- | FO-24P2 | | | - | 6 |
| | | 2011-2015 | TEX/DST80 | FO-30DP | TPX7 | TPX7 | TP33 | 3 |
| | | 2016- | PHI/CR3 | DEALER KEY | | | - | |
| EXPLORER SPORT TRAC | | 2000-2001 | TEX/- | FO-15DCP | TPX1/TPX6/TPX5 | TPX1/TPX6/TPX5 | TP02 | 3 |
| | | 2001-2010 | TEX/CR | FO-30DP | TPX2/TPX5/TPX6 | TPX2/TPX5/TPX6 | TP20 | 3 |
| F-150 | | 1999-2004 | TEX/- | FO-15DCP | TPX1/TPX6/TPX5 | TPX1/TPX6/TPX5 | TP02 | 3 |
| | | 2004-2010 | TEX/CR | FO-30DP | TPX2/TPX5/TPX6 | TPX2/TPX5/TPX6 | TP20 | 3 |
| | | 2011-2014 | TEX/DST80 | FO-30DP | TPX7 | TPX7 | TP33 | 3 |
| | | 2015-2019 | PHI/CR3 | FO-24P2 | | | TP39 | 6 |
| | | 2015- | PHI/CR3 | ORIGINAL | | | - | |
| | | 2015- | PHI/CR3 | DEALER KEY | | | - | |
| F-250 | | 1999-2004 | TEX/- | FO-15DCP | TPX1/TPX6/TPX5 | TPX1/TPX6/TPX5 | TP02 | 3 |
| | | 2004-2010 | TEX/CR | FO-30DP | TPX2/TPX5/TPX6 | TPX2/TPX5/TPX6 | TP20 | 3 |
| | | 2011-2016 | TEX/DST80 | FO-30DP | TPX7 | TPX7 | TP33 | 3 |
| | | 2017-2019 | PHI/CR3 | FO-24P2 | | | TP39 | 6 |
| | | 2017- | PHI/CR3 | DEALER KEY | | | - | |
| F-350 | | 1999-2003 | TEX/- | FO-15DP | TPX1/TPX6/TPX5 | TPX1/TPX6/TPX5 | TP02 | 6 |
| | | 2004-2010 | TEX/CR | FO-30DP | TPX2/TPX5/TPX6 | TPX2/TPX5/TPX6 | TP20 | 3 |
| | | 2011-2016 | TEX/CR | FO-30DP | TPX7 | TPX7 | TP33 | 3 |
| | | 2017- | PHI/CR3 | DEALER KEY | | | - | |
| F-450 | | 2004-2010 | TEX/CR | FO-30DP | TPX2/TPX5/TPX6 | TPX2/TPX5/TPX6 | TP20 | 3 |
| | | 2011-2016 | TEX/CR | FO-30DP | TPX2/TPX5/TPX6 | TPX2/TPX5/TPX6 | TP20 | 3 |
| | | 2017- | PHI/CR3 | DEALER KEY | | | - | |
| F-350/450/550 | | 2017-2019 | PHI/CR3 | FO-24P2 | | | TP39 | 6 |
| FIESTA | | 2011- | TEX/DST80 | FO-24P | TPX7 | TPX7 | TP33 | 6 |
| | | 2011- | TEX/DST80 | DEALER KEY | | | - | |
| FIVE HUNDRED | | 2005-2007 | TEX/CR | FO-30DP | TPX2/TPX5/TPX6 | TPX2/TPX5/TPX6 | TP20 | 3 |
| FLEX | | 2009-2012 | TEX/CR | FO-30DP | TPX2/TPX5/TPX6 | TPX2/TPX5/TPX6 | TP20 | 3 |
| | | 2011- | TEX/DST80 | FO-30DP | TPX7 | TPX7 | TP33 | 3 |
| | | 2013- | TEX/DST80 | DEALER KEY | | | - | |
| FOCUS | | 2000-2005 | TEX/CR | FO-15DCP | TPX2/TPX5/TPX6 | TPX2/TPX5/TPX6 | TP06 | 3 |
| | | 2006-2011 | TEX/CR | FO-30DP | TPX2/TPX5/TPX6 | TPX2/TPX5/TPX6 | TP20 | 3 |
| | | 2011-2011 | TEX/DST80 | FO-30DP | TPX7 | TPX7 | TP33 | 3 |
| | | 2012- | TEX/DST80 | FO-24P | TPX7 | TPX7 | TP33 | 6 |
| | | 2012- | TEX/DST80 | DEALER KEY | | | - | |
| FREESTAR | | 2004-2007 | TEX/CR | FO-30DP | TPX2/TPX5/TPX6 | TPX2/TPX5/TPX6 | TP20 | 3 |
| FREESTYLE | | 2005-2008 | TEX/CR | FO-30DP | TPX2/TPX5/TPX6 | TPX2/TPX5/TPX6 | TP20 | 3 |

| FOR: |  |  |  |  | TRS-5000 EVO | EVO XPERT | Programming TP |  |
|-------------------------|---|---|---|---|-----------------|----------------|-------------------|---|
| | FUSION | 2006-2012 | TEX/CR | FO-30DP | TPX2/TPX5/TPX6 | TPX2/TPX5/TPX6 | TP20 | 3 |
| | | 2011-2012 | TEX/DST80 | FO-30DP | TPX7 | TPX7 | TP33 | 3 |
| | | 2013- | TEX/DST80 | DEALER KEY | | | - | |
| | | 2014-2016 | PHI/CR3 | FO-24P2 | | | - | 6 |
| | | 2013- | PHI/CR3 | ORIGINAL | | | - | |
| | GT | 2005-2006 | TEX/- | FO-15DCP | TPX1/TPX6/TPX5 | TPX1/TPX6/TPX5 | TP02 | 3 |
| | | 2005-2006 | TEX/- | FO-30DP | TPX1/TPX6/TPX5 | TPX1/TPX6/TPX5 | TP02 | 3 |
| | LTD | 1998-2003 | TEX/- | FO-15DCP | TPX1/TPX6/TPX5 | TPX1/TPX6/TPX5 | TP02 | 3 |
| | MUSTANG | 1996-2004 | TEX/- | FO-15DCP | TPX1/TPX6/TPX5 | TPX1/TPX6/TPX5 | TP02 | 3 |
| | | 2005-2012 | TEX/CR | FO-30DP | TPX2/TPX5/TPX6 | TPX2/TPX5/TPX6 | TP20 | 3 |
| | | 2011-2014 | TEX/DST80 | FO-30DP | TPX7 | TPX7 | TP33 | 3 |
| | | 2011-2014 | TEX/DST80 | DEALER KEY | | | - | |
| | | 2015- | PHI/CR3 | DEALER KEY | | | - | |
| | RANGER V6 | 1999-2000 | TEX/- | FO-15DCP | TPX1/TPX6/TPX5 | TPX1/TPX6/TPX5 | TP02 | 3 |
| | RANGER | 2001-2012 | TEX/CR | FO-30DP | TPX2/TPX5/TPX6 | TPX2/TPX5/TPX6 | TP20 | 3 |
| | | 2011-2012 | TEX/DST80 | FO-30DP | TPX7 | TPX7 | TP33 | 3 |
| | TAURUS | 2000-2003 | TEX/CR | FO-30DP | TPX2/TPX5/TPX6 | TPX2/TPX5/TPX6 | TP06 | 3 |
| | | 2004-2011 | TEX/CR | FO-30DP | TPX2/TPX5/TPX6 | TPX2/TPX5/TPX6 | TP20 | 3 |
| | | 2010-2012 | TEX/CR | DEALER KEY | | | - | |
| | | 2011- | TEX/DST80 | FO-30DP | TPX7 | TPX7 | TP33 | 3 |
| 2013- | | TEX/DST80 | DEALER KEY | | | - | | |
| TAURUS LX | 1996-1999 | TEX/- | FO-15DCP | TPX1/TPX6/TPX5 | TPX1/TPX6/TPX5 | TP02 | 3 | |
| THUNDERBIRD | 2002- | TEX/CR | FO-15DCP | TPX2/TPX5/TPX6 | TPX2/TPX5/TPX6 | TP06 | 3 | |
| | 2003-2005 | TEX/CR | FO-30DP | TPX2/TPX5/TPX6 | TPX2/TPX5/TPX6 | TP20 | 3 | |
| TRANSIT | 2013- | TEX/DST80 | FO-24P | TPX7 | TPX7 | TP33 | 6 | |
| TRANSIT CONNECT | 2010-2012 | TEX/CR2 | FO-6P | TPX7 | TPX7 | TP33 | 6 | |
| | 2014- | TEX/DST80 | FO-24P | TPX7 | TPX7 | TP33 | 6 | |
| WINDSTAR | 1998-2000 | TEX/- | FO-15DCP | TPX1/TPX6/TPX5 | TPX1/TPX6/TPX5 | TP02 | 3 | |
| | 2001-2003 | TEX/CR | FO-30DP | TPX2/TPX5/TPX6 | TPX2/TPX5/TPX6 | TP20 | 3 | |
| GMC [®] | ACADIA | 2007-2016 | PHI/CR2 | GM-37P | TPX4/TPX5 | TPX4/TPX5 | TP12GM | 4 |
| | CANYON (CAN) | 2008-2012 | MEG/CR | ISU-3DP2 | TPX8+ | TPX8+ | TP08 | 12 |
| | | 2008-2012 | MEG/CR | ORIGINAL | | | - | |
| | CANYON | 2015- | PHI/CR2 | OP-11P5 | TPX4/TPX5 | TPX4/TPX5 | TP37 | 9 |
| | DENALI | 2007-2014 | PHI/CR2 | GM-37P | TPX4/TPX5 | TPX4/TPX5 | TP12GM | 4 |
| | | 2015- | PHI/CR2 | OP-11P5 | TPX4/TPX5 | TPX4/TPX5 | - | 9 |
| | ENVOY | 2007-2009 | PHI/CR2 | GM-37P | TPX4/TPX5 | TPX4/TPX5 | TP12GM | 4 |
| | SAVANA | 2008-2014 | PHI/CR2 | GM-37P | TPX4/TPX5 | TPX4/TPX5 | TP12GM | 4 |
| | | 2015- | PHI/CR2 | OP-11P5 | TPX4/TPX5 | TPX4/TPX5 | TP37 | 9 |
| | SIERRA | 2007-2013 | PHI/CR2 | GM-37P | TPX4/TPX5 | TPX4/TPX5 | TP12GM | 4 |
| | | 2014- | PHI/CR2 | OP-11P5 | TPX4/TPX5 | TPX4/TPX5 | TP37 | 9 |
| | | 2015- | PHI/CR2 | DEALER KEY | | | - | |
| | TERRAIN | 2010- | PHI/CR2 | OP-11P5 | TPX4/TPX5 | TPX4/TPX5 | TP37 | 9 |
| | YUKON | 2007-2014 | PHI/CR2 | GM-37P | TPX4/TPX5 | TPX4/TPX5 | TP12GM | 4 |
| 2015- | | PHI/CR2 | OP-11P5 | TPX4/TPX5 | TPX4/TPX5 | TP37 | 9 | |
| YUKON W/PROX | 2015- | PHI/CR2 | DEALER KEY | | | - | | |
| GREAT WALL [®] | HAFU | 2006- | MEG/CR | ISU-3DP2 | TPX8+ | TPX8+ | TP08 | 12 |
| | HOVER | 2006- | MEG/CR | ISU-3DP2 | TPX8+ | TPX8+ | TP08 | 12 |
| | STEED | 2009-2012 | MEG/CR | ISU-3DP2 | TPX8+ | TPX8+ | TP08 | 12 |
| | V SERIES | 2006- | MEG/CR | ISU-3DP2 | TPX8+ | TPX8+ | TP08 | 12 |
| | WINGLE | 2006- | MEG/CR | ISU-3DP2 | TPX8+ | TPX8+ | TP08 | 12 |

AUTOMÓVIL - CAMIONETA





CAR-PICK UP TRUCK

| FOR: |  |  |  |  | TRS-5000 EVO | EVO XPERT | Programming TP |  |
|----------------|---|---|---|---|-----------------|--------------|-------------------|---|
| HOLDEN® | X SERIES | 2006- | MEG/CR | ISU-3DP2 | TPX8+ | TPX8+ | TP08 | 12 |
| | ASTRA | 1995-1998 | PHI/- | OP-DP | TP01/TP05 | TP01/TP05 | TP01/TP05** | 9 |
| | | 1995-1998 | PHI/- | OP-SP | TP01/TP05 | TP01/TP05 | TP01/TP05** | 9 |
| | | 1998-2006 | PHI/CR | OP-SP | | | TP09 | 9 |
| | | 2004- | PHI/CR2 | OP-11P1 | TPX4/TPX5 | TPX4/TPX5 | TP12GM | 8 |
| | | 2004- | PHI/CR2 | ORIGINAL | | | - | |
| | BARINA | 1995-1998 | PHI/- | OP-DP | TP01/TP05 | TP01/TP05 | TP01/TP05** | 9 |
| | | 1995-1998 | PHI/- | OP-SP | TP01/TP05 | TP01/TP05 | TP01/TP05** | 9 |
| | | 1998-2006 | PHI/CR | OP-SP | | | TP09 | 9 |
| | | 1998-2006 | PHI/CR | OP-STL | | | TP09 | 9 |
| | | 2000-2004 | PHI/CR | OP-STL2 | | | TP09 | 9 |
| | | 2004-2006 | PHI/CR | OP-11TL2 | | | TP09 | 9 |
| | | 2006- | MEG/CR | DAE-3DP1 | TPX8+ | TPX8+ | TP08 | 1 |
| | | 2006- | PHI/CR2 | ORIGINAL | | | - | |
| | | 2011-2018 | PHI/CR2 | OP-11P1 | TPX4/TPX5 | TPX4/TPX5 | - | 8 |
| | BARINA SPARK | - | SOK/CR | DAE-3P1 | | | TP32 | 2 |
| | CAPTIVA | 2006-2015 | PHI/CR2 | DAE-4P1 | TPX4/TPX5 | TPX4/TPX5 | TP12GM | 2 |
| | COLORADO | 2008- | PHI/CR2 | ISU-3DP1 | TPX4/TPX5 | TPX4/TPX5 | TP12GM | 12 |
| | COMBO | 1998-2001 | PHI/- | OP-SP | TP05 | TP05 | TP01/TP05** | 9 |
| | COMMODORE VE | 2006- | PHI/CR2 | GM-49DP | TPX4/TPX5 | TPX4/TPX5 | TP12GM | 4 |
| | | 2006-2013 | PHI/CR2 | ORIGINAL | | | - | |
| | COMMODORE VF | 2013-2017 | PHI/CR2 | OP-11P1 | TPX4/TPX5 | TPX4/TPX5 | TP12GM | 8 |
| | FRONTERA | 1996-1999 | MEG/- | GM-4P1 | TP05 | TP05 | TP01/TP05** | 4 |
| | | 1999-2004 | MEG/CR | HOND-21P | TPX8+ | TPX8+ | TP08 | 4 |
| | JACKAROO | 1999-2002 | TEX/CR | ORIGINAL | | | - | |
| | VECTRA | 1995-1998 | PHI/- | OP-WHP | TP01/TP05 | TP01/TP05 | TP01/TP05** | 10 |
| | | 1995-1998 | PHI/- | OP-WYP | TP01/TP05 | TP01/TP05 | TP01/TP05** | 10 |
| | 1998-2004 | PHI/CR | OP-WHP | | | TP09 | 10 | |
| | 1998-2004 | PHI/CR | OP-WHTL | | | TP09 | 10 | |
| | 2004- | PHI/CR2 | OP-11P1 | TPX4/TPX5 | TPX4/TPX5 | TP12GM | 8 | |
| | 2004- | PHI/CR2 | ORIGINAL | | | - | | |
| VIVA | 2005-2009 | TEX/CR | ORIGINAL | | | - | | |
| ZAFIRA | 2004- | PHI/CR2 | OP-11P1 | TPX4/TPX5 | TPX4/TPX5 | TP12GM | 8 | |
| | 2004- | PHI/CR2 | ORIGINAL | | | - | | |
| HONDA® | ACCORD | 1995-1999 | PHI/- | NE-35P3 | TP01 | TP01 | TP01/TP05** | 5 |
| | | 1999-2002 | MEG/CR | HOND-21P | TPX8+ | TPX8+ | TP08 | 4 |
| | | 2003-2006 | MEG/CR | HOND-21P | TPX8+ | TPX8+ | TP08 | 4 |
| | | 2003-2006 | MEG/CR | HOND-31P | TPX8+ | TPX8+ | TP08 | 5 |
| | | 2003-2007 | PHI/CR2 | HOND-31P | TPX4/TPX5 | TPX4/TPX5 | TP12HN | 5 |
| | | 2006-2008 | SOK/CR | HOND-31P | | | TP32 | 5 |
| | | 2008-2012 | PHI/CR2 | HOND-31P | TPX4/TPX5 | TPX4/TPX5 | TP12HN | 5 |
| | ACCORD AERO D. | 1995-1997 | MEG/- | HOND-21P | TP05 | TP05 | TP03/TP05** | 4 |
| | ACCORD COUPE | 1995-2002 | MEG/- | HOND-21P | TP05 | TP05 | TP03/TP05** | 4 |
| | AIRWAVE (J) | 2005-2010 | SOK/CR | HOND-31P | | | TP32 | 5 |
| | AMAZE | 2010- | PHI/CR2 | HOND-31P | TPX4/TPX5 | TPX4/TPX5 | TP12HN | 5 |
| | BRIO | 2010- | PHI/CR2 | HOND-31P | TPX4/TPX5 | TPX4/TPX5 | TP12HN | 5 |
| | CITY | 2002-2007 | MEG/CR | HOND-31P | TPX8+ | TPX8+ | TP08 | 5 |
| | | 2008-2013 | PHI/CR2 | HOND-31P | TPX4/TPX5 | TPX4/TPX5 | TP12HN | 5 |
| | | 2014- | PHI/CR3 | HOND-31P | | | TP38 | 5 |
| | 2014- | PHI/CR3 | ORIGINAL | | | - | | |

| FOR: |  |  |  |  | TRS-5000 EVO | EVO XPERT | Programming TP |  |
|-------------|---|---|---|---|-----------------|--------------|-------------------|---|
| CIVIC | 1995-1999 | MEG/- | HOND-21P | TP05 | TP05 | TP03/TP05** | 4 | |
| | 1996-2000 | PHI/- | NE-35P3 | TP05 | TP05 | TP01/TP05** | 5 | |
| | 1999-2002 | MEG/CR | HOND-21P | TPX8+ | TPX8+ | TP08 | 4 | |
| | 2002-2005 | MEG/CR | HOND-31P | TPX8+ | TPX8+ | TP08 | 5 | |
| | 2006-2014 | PHI/CR2 | HOND-31P | TPX4/TPX5 | TPX4/TPX5 | TP12HN | 5 | |
| | 2014- | PHI/CR3 | HOND-31P | | | TP38 | 5 | |
| | 2014- | PHI/CR3 | ORIGINAL | | | - | | |
| CR-V | 1997-1999 | MEG/- | HOND-21P | TP05 | TP05 | TP03/TP05** | 4 | |
| | 1999-2001 | MEG/CR | HOND-21P | TPX8+ | TPX8+ | TP08 | 4 | |
| | 2002-2006 | MEG/CR | HOND-31P | TPX8+ | TPX8+ | TP08 | 5 | |
| | 2007-2014 | PHI/CR2 | HOND-31P | TPX4/TPX5 | TPX4/TPX5 | TP12HN | 5 | |
| | 2007-2014 | PHI/CR2 | DEALER KEY | | | - | | |
| | 2014- | PHI/CR3 | HOND-31P | | | TP38 | 5 | |
| | 2014- | PHI/CR3 | ORIGINAL | | | - | | |
| CR-Z | 2010-2016 | PHI/CR2 | HOND-31P | TPX4/TPX5 | TPX4/TPX5 | TP12HN | 5 | |
| EDIX (J) | 2004-2007 | MEG/CR | HOND-31P | TPX8+ | TPX8+ | TP08 | 5 | |
| | 2007-2009 | SOK/CR | HOND-31P | | | TP32 | 5 | |
| ELYSION (J) | 2004-2013 | PHI/CR2 | HOND-31P | TPX4/TPX5 | TPX4/TPX5 | TP12HN | 5 | |
| FR-V | 2004-2007 | MEG/CR | HOND-31P | TPX8+ | TPX8+ | TP08 | 5 | |
| | 2007-2011 | SOK/CR | HOND-31P | | | TP32 | 5 | |
| HR-V | 1999-2005 | MEG/CR | HOND-21P | TPX8+ | TPX8+ | TP08 | 4 | |
| | 2015- | PHI/CR3 | ORIGINAL | | | - | | |
| | 2015- | PHI/CR3 | DEALER KEY | | | - | | |
| INSIGHT | 2001-2005 | MEG/CR | HOND-21P | TPX8+ | TPX8+ | TP08 | 4 | |
| | 2009-2014 | PHI/CR2 | HOND-31P | TPX4/TPX5 | TPX4/TPX5 | TP12HN | 5 | |
| | 2009-2014 | PHI/CR2 | ORIGINAL | | | - | | |
| INTEGRA | 1998-2001 | MEG/- | HOND-21P | TP05 | TP05 | TP03/TP05** | 4 | |
| JAZZ | 2001-2007 | MEG/CR | HOND-31P | TPX8+ | TPX8+ | TP08 | 5 | |
| | 2006-2008 | SOK/CR | HOND-31P | | | TP32 | 5 | |
| | 2009-2014 | PHI/CR2 | HOND-31P | TPX4/TPX5 | TPX4/TPX5 | TP12HN | 5 | |
| | 2015- | PHI/CR3 | HOND-31P | | | TP38 | 5 | |
| | 2015- | PHI/CR3 | ORIGINAL | | | - | | |
| LEGEND | 1996-2005 | MEG/- | HOND-21P | TP05 | TP05 | TP03/TP05** | 4 | |
| | 2007-2012 | SOK/CR | HOND-31P | | | TP32 | 5 | |
| LOGO | 1999-2001 | MEG/CR | HOND-21P | TPX8+ | TPX8+ | TP08 | 4 | |
| NSX | 1997-2005 | MEG/- | HOND-21P | TP05 | TP05 | TP03/TP05** | 4 | |
| PARTNER (J) | 2006-2010 | SOK/CR | HOND-31P | | | TP32 | 5 | |
| PASSPORT | 1998-2002 | MEG/- | HOND-21P | TP05 | TP05 | TP03/TP05** | 4 | |
| PRELUDE | 1997-2001 | MEG/- | HOND-21P | TP05 | TP05 | TP03/TP05** | 4 | |
| S 2000 | 2000-2003 | MEG/CR | HOND-21P | TPX8+ | TPX8+ | TP08 | 4 | |
| | 2004-2005 | MEG/CR | HOND-31P | TPX8+ | TPX8+ | TP08 | 5 | |
| | 2006-2010 | SOK/CR | HOND-31P | | | TP32 | 5 | |
| SHUTTLE | 1995-2000 | MEG/- | HOND-21P | TP05 | TP05 | TP03/TP05** | 4 | |
| | 2000-2003 | MEG/CR | HOND-21P | TPX8+ | TPX8+ | TP08 | 4 | |
| STEPWGN | 2005-2009 | PHI/CR2 | HOND-31P | TPX4/TPX5 | TPX4/TPX5 | TP12HN | 5 | |
| | 2005-2009 | SOK/CR | HOND-31P | | | TP32 | 5 | |
| STREAM | 2001-2003 | MEG/CR | HOND-21P | TPX8+ | TPX8+ | TP08 | 4 | |
| | 2003-2007 | MEG/CR | HOND-31P | TPX8+ | TPX8+ | TP08 | 5 | |
| | 2008- | PHI/CR2 | HOND-31P | TPX4/TPX5 | TPX4/TPX5 | TP12HN | 5 | |
| VEZEL | 2013- | PHI/CR3 | HOND-31P | | | TP38 | 5 | |

AUTOMÓVIL - CAMIONETA





CAR-PICK UP TRUCK





| FOR: |  |  |  |  | TRS-5000 EVO | EVO XPERT | Programming TP |  |
|-------------------------------|---|---|---|---|-----------------|----------------|-------------------|---|
| HONDA® (AUSTRALIA) | CIVIC | 2002-2005 | MEG/- | HOND-31P | TP05 | TP05 | TP03/TP05** | 5 |
| | | 2003- | PHI/CR2 | HOND-31P | TPX4/TPX5 | TPX4/TPX5 | TP12HN | 5 |
| | CR-V | 2002-2006 | MEG/- | HOND-31P | TP05 | TP05 | TP03/TP05** | 5 |
| | JAZZ | 2001- | MEG/- | HOND-31P | TP05 | TP05 | TP03/TP05** | 5 |
| | MDX | 2003- | PHI/CR2 | HOND-31P | TPX4/TPX5 | TPX4/TPX5 | TP12HN | 5 |
| HONDA® (USA) | ACCORD | 1998-2002 | MEG/- | HOND-21P | TP05 | TP05 | TP03/TP05** | 4 |
| | | 2003-2012 | PHI/CR2 | HOND-31P | TPX4/TPX5 | TPX4/TPX5 | TP12HN | 5 |
| | ACCORD w/PROX | 2013- | PHI/CR3 | HOND-31P | | | TP38 | 5 |
| | | 2013- | PHI/CR3 | DEALER KEY | | | - | |
| | CIVIC | 2001-2002 | MEG/- | HOND-21P | TP05 | TP05 | TP03/TP05** | 4 |
| | | 2003-2005 | MEG/- | HOND-31P | TP05 | TP05 | TP03/TP05** | 5 |
| | | 2006-2013 | PHI/CR2 | HOND-31P | TPX4/TPX5 | TPX4/TPX5 | TP12HN | 5 |
| | CIVIC w/PROX | 2014- | PHI/CR3 | ORIGINAL | | | - | |
| | | 2014- | PHI/CR3 | DEALER KEY | | | - | |
| | CROSSTOUR | 2010-2012 | PHI/CR2 | HOND-31P | TPX4/TPX5 | TPX4/TPX5 | TP12HN | 5 |
| | | 2013- | PHI/CR3 | HOND-31P | | | TP38 | 5 |
| | CROSSTOUR w/PROX | 2013- | PHI/CR3 | DEALER KEY | | | - | |
| | CR-V | 2002-2006 | MEG/- | HOND-31P | TP05 | TP05 | TP03/TP05** | 5 |
| | | 2007-2013 | PHI/CR2 | HOND-31P | TPX4/TPX5 | TPX4/TPX5 | TP12HN | 5 |
| | | 2014-2018 | PHI/CR3 | HOND-31P | | | TP38 | 5 |
| | | 2014- | PHI/CR3 | DEALER KEY | | | - | |
| | CR-Z | 2011-2014 | PHI/CR2 | HOND-31P | TPX4/TPX5 | TPX4/TPX5 | TP12HN | 5 |
| | ELEMENT | 2003-2005 | MEG/- | HOND-31P | TP05 | TP05 | TP03/TP05** | 5 |
| | | 2006-2011 | PHI/CR2 | HOND-31P | TPX4/TPX5 | TPX4/TPX5 | TP12HN | 5 |
| | FIT | 2007-2008 | SOK/CR | HOND-31P | | | TP32 | 5 |
| | | 2009-2014 | PHI/CR2 | HOND-31P | TPX4/TPX5 | TPX4/TPX5 | TP12HN | 5 |
| | | 2015- | PHI/CR3 | HOND-31P | | | TP38 | 5 |
| | | 2015- | PHI/CR3 | DEALER KEY | | | - | |
| | HR-V | 2016- | PHI/CR3 | HOND-31P | | | TP38 | 5 |
| | | 2016- | PHI/CR3 | DEALER KEY | | | - | |
| | INSIGHT | 2000-2006 | MEG/- | HOND-21P | TP05 | TP05 | TP03/TP05** | 4 |
| | | 2010-2014 | PHI/CR2 | HOND-31P | TPX4/TPX5 | TPX4/TPX5 | TP12HN | 5 |
| | ODYSSEY | 1998-2002 | MEG/- | HOND-21P | TP05 | TP05 | TP03/TP05** | 4 |
| | | 2003-2004 | MEG/- | HOND-31P | TP05 | TP05 | TP03/TP05** | 5 |
| | | 2005-2016 | PHI/CR2 | HOND-31P | TPX4/TPX5 | TPX4/TPX5 | TP12HN | 5 |
| | ODYSSEY w/PROX | 2014- | PHI/CR3 | DEALER KEY | | | - | |
| | PILOT | 2003-2005 | MEG/- | HOND-31P | TP05 | TP05 | TP03/TP05** | 5 |
| | 2006-2015 | PHI/CR2 | HOND-31P | TPX4/TPX5 | TPX4/TPX5 | TP12HN | 5 | |
| PRELUDE | 1997-2002 | MEG/- | HOND-21P | TP05 | TP05 | TP03/TP05** | 4 | |
| RIDGELINE | 2006-2014 | PHI/CR2 | HOND-31P | TPX4/TPX5 | TPX4/TPX5 | TP12HN | 5 | |
| S 2000 | 2000-2003 | MEG/- | HOND-21P | TP05 | TP05 | TP03/TP05** | 4 | |
| | 2004-2005 | MEG/- | HOND-31P | TP05 | TP05 | TP03/TP05** | 5 | |
| | 2006-2007 | SOK/CR | HOND-31P | | | TP32 | 5 | |
| | 2008-2009 | PHI/CR2 | HOND-31P | TPX4/TPX5 | TPX4/TPX5 | TP12HN | 5 | |
| HUMMER® | H2 | 2008-2009 | PHI/CR2 | GM-37P | TPX4/TPX5 | TPX4/TPX5 | TP12GM | 4 |
| | H2 SUT | 2008-2009 | PHI/CR2 | GM-37P | TPX4/TPX5 | TPX4/TPX5 | TP12GM | 4 |
| | H3 | 2008-2010 | MEG/CR | ISU-3DP2 | TPX8+ | TPX8+ | TP08 | 12 |
| HYUNDAI® | ACCENT | 1996-1999 | TEX/- | HY-5P1 | TPX1/TPX6/TPX5 | TPX1/TPX6/TPX5 | TP07 | 11 |
| | | 1999-2011 | PHI/CR2 | HY-4P1 | TPX4/TPX5 | TPX4/TPX5 | TP12 | 11 |

| FOR: |  |  |  |  | TRS-5000 EVO | EVO XPERT | Programming TP |  |
|---------------|---|---|---|---|-----------------|----------------|-------------------|---|
| | | 2012- | PHI/CR2 | HY-18P | TPX4/TPX5 | TPX4/TPX5 | TP12 | 11 |
| | | 2012- | PHI/CR2 | ORIGINAL | | | - | |
| AMICA | | 1997-2001 | TEX/- | HY-5P1 | TPX1/TPX6/TPX5 | TPX1/TPX6/TPX5 | TP07 | 11 |
| | | 2004-2008 | PHI/CR2 | HY-5P1 | TPX4/TPX5 | TPX4/TPX5 | TP12 | 11 |
| ATOS | | 1997-2000 | TEX/- | HY-5P1 | TPX1/TPX6/TPX5 | TPX1/TPX6/TPX5 | TP07 | 11 |
| ATOS PRIME | | 1999-2001 | TEX/- | HY-5P1 | TPX1/TPX6/TPX5 | TPX1/TPX6/TPX5 | TP07 | 11 |
| | | 2002-2008 | PHI/CR2 | HY-5P1 | TPX4/TPX5 | TPX4/TPX5 | TP12 | 11 |
| AVANTE | | 2000-2006 | PHI/CR2 | HY-4P1 | TPX4/TPX5 | TPX4/TPX5 | TP12 | 11 |
| | | 2007-2009 | PHI/CR2 | HY-11P1 | TPX4/TPX5 | TPX4/TPX5 | TP12 | 11 |
| | | 2009-2011 | PHI/CR2 | ORIGINAL | | | - | |
| | | 2010-2011 | PHI/CR2 | HY-18P | TPX4/TPX5 | TPX4/TPX5 | TP12 | 11 |
| AZERA | | 2006-2011 | PHI/CR2 | HY-18P | TPX4/TPX5 | TPX4/TPX5 | TP12 | 11 |
| COUPE | | 1996-2001 | TEX/- | HY-4P1 | TPX1/TPX6/TPX5 | TPX1/TPX6/TPX5 | TP07 | 11 |
| | | 2001-2009 | PHI/CR2 | HY-4P1 | TPX4/TPX5 | TPX4/TPX5 | TP12 | 11 |
| CRETA | | 2014- | TEX/DST80 | HY-11DP1 | TPX7 | TPX7 | TP46 | 11 |
| | | 2014- | TEX/DST80 | ORIGINAL | | | - | |
| ELANTRA | | 1999-2000 | TEX/- | HY-4P1 | TPX1/TPX6/TPX5 | TPX1/TPX6/TPX5 | TP07 | 11 |
| | | 2000-2006 | PHI/CR2 | HY-4P1 | TPX4/TPX5 | TPX4/TPX5 | TP12 | 11 |
| | | 2007-2016 | PHI/CR2 | HY-11DP1 | TPX4/TPX5 | TPX4/TPX5 | TP12 | 11 |
| ELANTRA NEOS | | 2007-2010 | PHI/CR2 | HY-18P | TPX4/TPX5 | TPX4/TPX5 | TP12 | 11 |
| ENTOURAGE | | 2007-2009 | PHI/CR2 | HY-11P1 | TPX4/TPX5 | TPX4/TPX5 | TP12 | 11 |
| EON | | 2010- | TEX/DST80 | HY-11P1 | TPX7 | TPX7 | TP46 | 11 |
| | | 2010- | TEX/DST80 | ORIGINAL | | | - | |
| EQUUS | | 2011-2015 | PHI/CR2 | DEALER KEY | | | - | |
| EXCEL | | 1996-1999 | TEX/- | HY-5P1 | TPX1/TPX6/TPX5 | TPX1/TPX6/TPX5 | TP07 | 11 |
| | | 1999-2000 | PHI/CR2 | HY-4P1 | TPX4/TPX5 | TPX4/TPX5 | TP12 | 11 |
| GALLOPER | | 1999-2003 | TEX/- | HY-4P1 | TPX1/TPX6/TPX5 | TPX1/TPX6/TPX5 | TP07 | 11 |
| GENESIS | | 2009-2010 | PHI/CR2 | HY-18P | TPX4/TPX5 | TPX4/TPX5 | TP12 | 11 |
| | | 2009-2014 | PHI/CR2 | DEALER KEY | | | - | |
| | | 2015- | PHI/CR2 | DEALER KEY | | | - | |
| GENESIS COUPE | | 2010-2014 | PHI/CR2 | HY-11DP1 | TPX4/TPX5 | TPX4/TPX5 | TP12 | 11 |
| | | 2010-2015 | PHI/CR2 | DEALER KEY | | | - | |
| GETZ | | 2002-2009 | PHI/CR2 | HY-4P1 | TPX4/TPX5 | TPX4/TPX5 | TP12 | 11 |
| GRANDEUR | | 2006- | PHI/CR2 | HY-18P | TPX4/TPX5 | TPX4/TPX5 | TP12 | 11 |
| H-1 | | 1999-2006 | TEX/- | HY-4P1 | TPX1/TPX6/TPX5 | TPX1/TPX6/TPX5 | TP07 | 11 |
| | | 2006-2007 | PHI/CR2 | HY-4P1 | TPX4/TPX5 | TPX4/TPX5 | TP12 | 11 |
| | | 2007-2015 | PHI/CR2 | HY-11P1 | TPX4/TPX5 | TPX4/TPX5 | TP12 | 11 |
| H-1 BUS | | 2007-2015 | PHI/CR2 | HY-11P1 | TPX4/TPX5 | TPX4/TPX5 | TP12 | 11 |
| HB20 (BRAZIL) | | 2012- | TEX/DST80 | HY-11DP1 | TPX7 | TPX7 | TP46 | 11 |
| | | 2012- | TEX/DST80 | ORIGINAL | | | - | |
| 110 | | 2008-2013 | PHI/CR2 | HY-11P1 | TPX4/TPX5 | TPX4/TPX5 | TP12 | 11 |
| | | 2014- | PHI/CR3 | HY-18P | | | - | 11 |
| | | 2014- | PHI/CR3 | ORIGINAL | | | - | |
| 120 | | 2008-2014 | PHI/CR2 | HY-18P | TPX4/TPX5 | TPX4/TPX5 | TP12 | 11 |
| | | 2008-2014 | PHI/CR2 | TOYO-18P | TPX4/TPX5 | TPX4/TPX5 | - | 18 |
| | | 2014- | PHI/CR3 | HY-18P | | | - | 11 |
| | | 2014- | PHI/CR3 | ORIGINAL | | | - | |
| 130 | | 2007-2011 | PHI/CR2 | HY-18P | TPX4/TPX5 | TPX4/TPX5 | TP12 | 11 |
| | | 2007-2011 | PHI/CR2 | ORIGINAL | | | - | |
| | | 2007-2011 | PHI/CR2 | DEALER KEY | | | - | |

AUTOMÓVIL - CAMIONETA





CAR-PICK UP TRUCK





| FOR: |  |  |  |  | TRS-5000 EVO | EVO XPERT | Programming TP |  |
|------------|---|---|---|---|-----------------|----------------|-------------------|---|
| | | 2012-2016 | TEX/DST80 | HY-18P | TPX7 | TPX7 | TP46 | 11 |
| | | 2017- | TEX/DST80 | HY-20P1 | TPX7 | TPX7 | - | 12 |
| | | 2017- | TEX/DST80 | ORIGINAL | | | - | |
| | | 2017- | PHI/CR3 | DEALER KEY | | | - | |
| I40 | | 2011- | TEX/DST80 | HY-18P | TPX7 | TPX7 | TP46 | 11 |
| | | 2011- | TEX/DST80 | DEALER KEY | | | - | |
| | | 2013-2015 | TEX/DST80 | HY-18P | TPX7 | TPX7 | TP46 | 11 |
| I45 | | 2009- | PHI/CR2 | HY-18P | TPX4/TPX5 | TPX4/TPX5 | TP12 | 11 |
| ILOAD | | 2007-2014 | PHI/CR2 | HY-11DP1 | TPX4/TPX5 | TPX4/TPX5 | TP12 | 11 |
| IMAX | | 2007-2015 | PHI/CR2 | HY-11DP1 | TPX4/TPX5 | TPX4/TPX5 | TP12 | 11 |
| INNOVATION | | 1999-2003 | TEX/- | HY-4P1 | TPX1/TPX6/TPX5 | TPX1/TPX6/TPX5 | TP07 | 11 |
| IONIQ | | 2016- | TEX/DST80 | HY-20P1 | TPX7 | TPX7 | - | 12 |
| IX20 | | 2010-2012 | PHI/CR2 | HY-18P | TPX4/TPX5 | TPX4/TPX5 | TP12 | 11 |
| | | 2010-2012 | PHI/CR2 | ORIGINAL | | | - | |
| | | 2012- | TEX/DST80 | HY-18P | TPX7 | TPX7 | TP46 | 11 |
| | | 2012- | TEX/DST80 | ORIGINAL | | | - | |
| IX35 | | 2010-2015 | PHI/CR2 | HY-18P | TPX4/TPX5 | TPX4/TPX5 | TP12 | 11 |
| | | 2010-2015 | PHI/CR2 | ORIGINAL | | | - | |
| | | 2010-2015 | PHI/CR2 | DEALER KEY | | | - | |
| KONA | | 2017- | TEX/DST80 | HY-20P1 | TPX7 | TPX7 | - | 12 |
| | | 2017- | TEX/DST80 | ORIGINAL | | | - | |
| | | 2017- | PHI/CR3 | DEALER KEY | | | - | |
| LANTRA | | 1996-2000 | TEX/- | HY-4P1 | TPX1/TPX6/TPX5 | TPX1/TPX6/TPX5 | TP07 | 11 |
| | | 2000-2006 | PHI/CR2 | HY-4P1 | TPX4/TPX5 | TPX4/TPX5 | TP12 | 11 |
| | | 2007-2011 | PHI/CR2 | HY-18P | TPX4/TPX5 | TPX4/TPX5 | TP12 | 11 |
| LAVITA | | 2001-2010 | PHI/CR2 | HY-4P1 | TPX4/TPX5 | TPX4/TPX5 | TP12 | 11 |
| MATRIX | | 2002-2010 | PHI/CR2 | HY-4P1 | TPX4/TPX5 | TPX4/TPX5 | TP12 | 11 |
| NEXO | | 2019- | PHI/CR3 | DEALER KEY | | | - | |
| PONY | | 1995-1999 | TEX/- | HY-5P1 | TPX1/TPX6/TPX5 | TPX1/TPX6/TPX5 | TP07 | 11 |
| SANTAFE | | 2000-2002 | TEX/CR | HY-6DP1 | TPX2/TPX5/TPX6 | TPX2/TPX5/TPX6 | TP19 | 11 |
| | | 2002-2006 | PHI/CR2 | HY-4P1 | TPX4/TPX5 | TPX4/TPX5 | TP12 | 11 |
| | | 2006-2012 | PHI/CR2 | HY-11DP1 | TPX4/TPX5 | TPX4/TPX5 | TP12 | 11 |
| | | 2011-2012 | PHI/CR2 | HY-11RKE | TPX4/TPX5 | TPX4/TPX5 | - | 11 |
| | | 2013- | PHI/CR2 | HY-19P1 | TPX4/TPX5 | TPX4/TPX5 | TP12 | 12 |
| | | 2013- | PHI/CR2 | DEALER KEY | | | - | |
| | | 2013- | TEX/DST80 | HY-19P1 | TPX7 | TPX7 | TP46 | 12 |
| | | 2013- | TEX/DST80 | ORIGINAL | | | - | |
| SANTAMO | | 2000-2003 | TEX/- | HY-4P1 | TPX1/TPX6/TPX5 | TPX1/TPX6/TPX5 | TP07 | 11 |
| SCOUPE | | 1996- | TEX/- | HY-4P1 | TPX1/TPX6/TPX5 | TPX1/TPX6/TPX5 | TP07 | 11 |
| SOLARIS | | 2011- | PHI/CR2 | HY-18P | TPX4/TPX5 | TPX4/TPX5 | TP12 | 11 |
| | | 2015-2017 | PHI/CR2 | HY-20P1 | TPX4/TPX5 | TPX4/TPX5 | TP12 | 12 |
| SONATA | | 1996-1998 | TEX/- | HY-6DP1 | TPX1/TPX6/TPX5 | TPX1/TPX6/TPX5 | TP07 | 11 |
| | | 1998-2004 | TEX/CR | HY-6DP1 | TPX2/TPX5/TPX6 | TPX2/TPX5/TPX6 | TP19 | 11 |
| | | 2005-2010 | PHI/CR2 | HY-11DP1 | TPX4/TPX5 | TPX4/TPX5 | TP12 | 11 |
| | | 2011-2015 | PHI/CR2 | HY-11RKE | TPX4/TPX5 | TPX4/TPX5 | TP12 | 11 |
| | | 2011-2015 | PHI/CR2 | HY-18P | TPX4/TPX5 | TPX4/TPX5 | TP12 | 11 |
| | | 2011-2015 | PHI/CR2 | DEALER KEY | | | - | |
| | | 2015- | TEX/DST80 | HY-18P | TPX7 | TPX7 | TP46 | 11 |
| SONICA | | 1996-1999 | TEX/- | HY-6DP1 | TPX1/TPX6/TPX5 | TPX1/TPX6/TPX5 | TP07 | 11 |
| | | 1999-2004 | TEX/CR | HY-6DP1 | TPX2/TPX5/TPX6 | TPX2/TPX5/TPX6 | TP19 | 11 |

| FOR: |  |  |  |  | TRS-5000 EVO | EVO XPERT | Programming TP |  |
|--------------------------------------|---|---|---|---|-----------------|----------------|-------------------|---|
| | | 1999-2004 | TEX/CR | ORIGINAL | | | - | |
| STAREX | | 1998-2006 | TEX/- | HY-9P1 | TPX1/TPX6/TPX5 | TPX1/TPX6/TPX5 | TP07 | 11 |
| | | 2007- | PHI/CR2 | HY-11P1 | TPX4/TPX5 | TPX4/TPX5 | TP12 | 11 |
| TERRACAN | | 2001-2007 | PHI/CR2 | HY-4P1 | TPX4/TPX5 | TPX4/TPX5 | TP12 | 11 |
| TIBURON | | 2001-2010 | PHI/CR2 | HY-4P1 | TPX4/TPX5 | TPX4/TPX5 | TP12 | 11 |
| TRAJET | | 1999-2007 | PHI/CR2 | HY-6DP1 | TPX4/TPX5 | TPX4/TPX5 | TP12 | 11 |
| | | 1999-2007 | PHI/CR2 | ORIGINAL | | | - | |
| | | 2000-2006 | TEX/CR | HY-6DP1 | TPX2/TPX5/TPX6 | TPX2/TPX5/TPX6 | TP19 | 11 |
| | | 2000-2006 | TEX/CR | ORIGINAL | | | - | |
| TUCSON | | 2004-2010 | PHI/CR2 | HY-4P1 | TPX4/TPX5 | TPX4/TPX5 | TP12 | 11 |
| | | 2010-2015 | PHI/CR2 | HY-18P | TPX4/TPX5 | TPX4/TPX5 | TP12 | 11 |
| | | 2010-2015 | PHI/CR2 | HY-11DP1 | TPX4/TPX5 | TPX4/TPX5 | TP12 | 11 |
| | | 2010-2015 | PHI/CR2 | ORIGINAL | | | - | |
| | | 2015- | TEX/DST80 | HY-18P | TPX7 | TPX7 | TP46 | 11 |
| VELOSTER | | 2010- | TEX/DST80 | TEX/DST80 | HY-19DP1 | TPX7 | TPX7 | TP46 |
| | | 2010- | TEX/DST80 | ORIGINAL | | | - | |
| | | 2010- | TEX/DST80 | DEALER KEY | | | - | |
| VERACRUZ | | 2007-2012 | PHI/CR2 | HY-11DP1 | TPX4/TPX5 | TPX4/TPX5 | TP12 | 11 |
| | | 2011-2012 | PHI/CR2 | DEALER KEY | | | - | |
| VERNA | | 1996-1999 | TEX/- | HY-5P1 | TPX1/TPX6/TPX5 | TPX1/TPX6/TPX5 | TP07 | 11 |
| | | 1999-2010 | PHI/CR2 | HY-4P1 | TPX4/TPX5 | TPX4/TPX5 | TP12 | 11 |
| | | 2011- | PHI/CR2 | HY-18P | TPX4/TPX5 | TPX4/TPX5 | TP12 | 11 |
| XG 25/XG30 | | 1998-2005 | TEX/CR | HY-6DP1 | TPX2/TPX5/TPX6 | TPX2/TPX5/TPX6 | TP19 | 11 |
| | | 1998-2005 | TEX/CR | ORIGINAL | | | - | |
| HYUNDAI[®] (AUS) | | 2012- | PHI/CR2 | HY-19DP1 | TPX4/TPX5 | TPX4/TPX5 | TP12 | 12 |
| GRANDEUR XG | | 1998-2005 | TEX/CR | HY-6DP1 | TPX2/TPX5/TPX6 | TPX2/TPX5/TPX6 | - | 11 |
| I40 | | 2010- | PHI/CR2 | HY-18P | TPX4/TPX5 | TPX4/TPX5 | TP12 | 11 |
| SANTAFE | | 2013- | PHI/CR2 | HY-19P1 | TPX4/TPX5 | TPX4/TPX5 | TP12 | 12 |
| VELOSTER | | 2012- | PHI/CR2 | HY-19DP1 | TPX4/TPX5 | TPX4/TPX5 | TP12 | 12 |
| HYUNDAI[®] (USA) | | 1999-2010 | PHI/CR2 | HY-11P1 | TPX4/TPX5 | TPX4/TPX5 | TP12 | 11 |
| | | 2012-2016 | PHI/CR2 | HY-18RKE | TPX4/TPX5 | TPX4/TPX5 | TP12 | 12 |
| AZERA | | 2006-2011 | PHI/CR2 | HY-18P | TPX4/TPX5 | TPX4/TPX5 | TP12 | 11 |
| AZERA w/PROX | | 2013-2015 | PHI/CR2 | DEALER KEY | | | - | |
| ELANTRA (CAN) | | 2000-2006 | PHI/CR2 | HY-11P1 | TPX4/TPX5 | TPX4/TPX5 | TP12 | 11 |
| | | 2007-2016 | PHI/CR2 | HY-11DP1 | TPX4/TPX5 | TPX4/TPX5 | TP12 | 11 |
| ELANTRA TOUR. (CAN) | | 2009-2012 | PHI/CR2 | HY-18P | TPX4/TPX5 | TPX4/TPX5 | TP12 | 11 |
| ELANTRA w/PROX | | 2011- | PHI/CR2 | DEALER KEY | | | - | |
| ELANTRA GT (CAN) | | 2013-2017 | TEX/DST80 | HY-19DP1 | TPX7 | TPX7 | TP46 | 12 |
| ENTOURAGE (CAN) | | 2006-2009 | PHI/CR2 | HY-11DP1 | TPX4/TPX5 | TPX4/TPX5 | TP12 | 11 |
| GENESIS 4 w/PROX DR | | 2009-2010 | PHI/CR2 | HY-18P | TPX4/TPX5 | TPX4/TPX5 | TP12 | 11 |
| | | 2009-2015 | PHI/CR2 | DEALER KEY | | | - | |
| GENESIS COUPE | | 2010-2014 | PHI/CR2 | HY-11DP1 | TPX4/TPX5 | TPX4/TPX5 | TP12 | 11 |
| | | 2010-2015 | PHI/CR2 | DEALER KEY | | | - | |
| SANTAFE (CANADA) | | 2002-2006 | PHI/CR2 | HY-11P1 | TPX4/TPX5 | TPX4/TPX5 | TP12 | 11 |
| | | 2007-2010 | PHI/CR2 | HY-11DP1 | TPX4/TPX5 | TPX4/TPX5 | TP12 | 11 |
| SANTAFE w/PROX | | 2013-2018 | PHI/CR2 | DEALER KEY | | | - | |
| SANTAFE | | 2018- | PHI/CR3 | DEALER KEY | | | - | |
| SONATA (CAN) | | 2011-2016 | PHI/CR2 | HY-18P | TPX4/TPX5 | TPX4/TPX5 | TP12 | 11 |

AUTOMÓVIL - CAMIONETA





CAR-PICK UP TRUCK

| FOR: |  |  |  |  | TRS-5000 EVO | EVO XPERT | Programming TP |  | |
|-------------|---|---|---|---|-----------------|----------------|-------------------|---|----|
| | SONATA w/PROX | 2011-2014 | PHI/CR2 | HY-18RKE | TPX4/TPX5 | TPX4/TPX5 | TP12 | 12 | |
| | SONATA | 2011- | PHI/CR2 | DEALER KEY | | | - | | |
| | TIBURON (CANADA) | 2001-2010 | PHI/CR2 | HY-11P1 | TPX4/TPX5 | TPX4/TPX5 | TP12 | 11 | |
| | TUCSON (CANADA) | 2005-2009 | PHI/CR2 | HY-11P1 | TPX4/TPX5 | TPX4/TPX5 | TP12 | 11 | |
| | | 2010-2012 | PHI/CR2 | HY-11DP1 | TPX4/TPX5 | TPX4/TPX5 | TP12 | 11 | |
| | | 2013-2015 | PHI/CR2 | HY-18P | TPX4/TPX5 | TPX4/TPX5 | TP12 | 11 | |
| | VELOSTER w/PROX | 2012-2016 | PHI/CR2 | DEALER KEY | | | - | | |
| | VERACRUZ (CAN) | 2007-2010 | PHI/CR2 | HY-11P1 | TPX4/TPX5 | TPX4/TPX5 | TP12 | 11 | |
| | VERACRUZ w/PROX | 2008-2012 | PHI/CR2 | DEALER KEY | | | - | | |
| | XG 300 (CANADA) | 2002-2005 | TEX/CR | HY-6DP1 | TPX2/TPX5/TPX6 | TPX2/TPX5/TPX6 | TP19 | 11 | |
| | INFINITI® (NISSAN®) | EX35 | 2008-2013 | PHI/CR2 | ORIGINAL | | | - | |
| | | | 2008-2013 | PHI/CR2 | DEALER KEY | | | - | |
| | | EX37 | 2013- | PHI/CR2 | DEALER KEY | | | - | |
| | | FX35 / FX45 | 2003-2008 | PHI/CR2 | DAT-15P2 | TPX4/TPX5 | TPX4/TPX5 | TP12NS | 15 |
| 2003-2008 | | | PHI/CR2 | DAT-15P3 | TPX4/TPX5 | TPX4/TPX5 | TP12NS | 16 | |
| 2003-2008 | | | PHI/CR2 | DEALER KEY | | | - | | |
| FX35 / FX50 | | 2009-2013 | PHI/CR2 | DEALER KEY | | | - | | |
| G20 | | 2000-2002 | TEX/CR | DAT-15P3 | TPX2/TPX5/TPX6 | TPX2/TPX5/TPX6 | TP19 | 16 | |
| G25 | | 2011-2012 | PHI/CR2 | DEALER KEY | | | - | | |
| G35 | | 2003-2008 | PHI/CR2 | DAT-15P3 | TPX4/TPX5 | TPX4/TPX5 | TP12NS | 16 | |
| G35 4dr | | 2005-2008 | PHI/CR2 | DEALER KEY | | | - | | |
| G37 | | 2008-2014 | PHI/CR2 | DEALER KEY | | | - | | |
| I30 / I35 | | 1999-1999 | PHI/CR | DAT-6P2 | TP05 | TP05 | TP01/TP05** | 15 | |
| | | 2000-2004 | TEX/CR | DAT-15P3 | TPX2/TPX5/TPX6 | TPX2/TPX5/TPX6 | TP19 | 16 | |
| IPL G.C.PE | | 2011-2012 | PHI/CR2 | DEALER KEY | | | - | | |
| JX35 | | 2013-2015 | PHI/CR2 | DEALER KEY | | | - | | |
| M35 | | 2003-2010 | PHI/CR2 | DEALER KEY | | | - | | |
| M37 | | 2011-2013 | PHI/CR2 | DEALER KEY | | | - | | |
| M45 | | 2003-2004 | PHI/CR2 | DEALER KEY | | | - | | |
| | | 2003-2006 | PHI/CR2 | DAT-15P3 | TPX4/TPX5 | TPX4/TPX5 | TP12NS | | |
| | | 2006-2010 | PHI/CR2 | DEALER KEY | | | - | | |
| M56 | | 2011-2013 | PHI/CR2 | DEALER KEY | | | - | | |
| Q45 | | 1997-2001 | TEX/- | DAT-15P4 | TPX1/TPX6/TPX5 | TPX1/TPX6/TPX5 | TP07 | 16 | |
| | | 2002-2005 | PHI/CR2 | DAT-15P3 | TPX4/TPX5 | TPX4/TPX5 | TP12NS | 16 | |
| Q50 | | 2014- | PHI/CR2 | DEALER KEY | | | - | | |
| Q60 | | 2014- | PHI/CR2 | DEALER KEY | | | - | | |
| Q70 | | 2014- | PHI/CR2 | DEALER KEY | | | - | | |
| QX4 | | 1997-1998 | TEX/- | DAT-15P2 | TPX1/TPX6/TPX5 | TPX1/TPX6/TPX5 | TP07 | 15 | |
| | 1999-2003 | TEX/CR | DAT-15P4 | TPX2/TPX5/TPX6 | TPX2/TPX5/TPX6 | TP19 | 16 | | |
| QX50 | 2014- | PHI/CR2 | DEALER KEY | | | - | | | |
| QX56 | 2004-2007 | PHI/CR2 | DAT-15P3 | TPX4/TPX5 | TPX4/TPX5 | TP12NS | | | |
| | 2008-2013 | PHI/CR2 | DEALER KEY | | | - | | | |
| QX60 | 2014- | PHI/CR2 | DEALER KEY | | | - | | | |
| QX70 | 2014- | PHI/CR2 | DEALER KEY | | | - | | | |
| QX80 | 2014- | PHI/CR2 | DEALER KEY | | | - | | | |
| ISUZU® | ASCENDER | 2003-2012 | MEG/CR | ISU-3DP2 | TPX8+ | TPX8+ | TP08 | 12 | |
| | AXIOM | 2003-2004 | MEG/CR | HOND-21P | TPX8+ | TPX8+ | TP08 | 4 | |
| | | 2003-2004 | MEG/CR | ORIGINAL | | | - | | |
| | BIG HORN | 1998-2002 | TEX/CR | SUZU-10P1 | TPX2/TPX5/TPX6 | TPX2/TPX5/TPX6 | TP21 | 17 | |

| FOR: |  |  |  |  | TRS-5000 EVO | EVO XPERT | Programming TP |  |
|---------------|---|---|---|---|-----------------|----------------|-------------------|---|
| | D-MAX | 1998-2002 | TEX/CR | ORIGINAL | | | - | |
| | | 2002-2006 | MEG/CR | ISU-3DP2 | TPX8+ | TPX8+ | TP08 | 12 |
| | | 2002-2006 | MEG/CR | ORIGINAL | | | - | |
| | | 2007- | PHI/CR2 | ISU-3DP1 | TPX4/TPX5 | TPX4/TPX5 | TP12GM | 12 |
| | | 2007- | PHI/CR2 | ORIGINAL | | | - | |
| | I-280 | 2004-2007 | MEG/CR | ISU-3DP2 | TPX8+ | TPX8+ | TP08 | 12 |
| | I-290 | 2007-2012 | MEG/CR | ISU-3DP2 | TPX8+ | TPX8+ | TP08 | 12 |
| | I-350 | 2004-2006 | MEG/CR | ISU-3DP2 | TPX8+ | TPX8+ | TP08 | 12 |
| | I-370 | 2007-2012 | MEG/CR | ISU-3DP2 | TPX8+ | TPX8+ | TP08 | 12 |
| | KB240 | 2007- | MEG/CR | ISU-3DP2 | TPX8+ | TPX8+ | TP08 | 12 |
| | KB300 | 2007- | MEG/CR | ISU-3DP2 | TPX8+ | TPX8+ | TP08 | 12 |
| | RODEO | 1999-2004 | MEG/CR | HOND-21P | TPX8+ | TPX8+ | TP08 | 4 |
| | | 2004-2010 | MEG/CR | ISU-3DP2 | TPX8+ | TPX8+ | TP08 | 12 |
| | | 2006-2008 | MEG/CR | HOND-21P | TPX8+ | TPX8+ | TP08 | 4 |
| TROOPER | 1996-1998 | MEG/- | GM-4P1 | TP05 | TP05 | TP03/TP05** | 4 | |
| | 1998-2003 | TEX/CR | SUZU-10P1 | TPX2/TPX5/TPX6 | TPX2/TPX5/TPX6 | TP21 | 17 | |
| ISUZU® (USA) | AXIOM | 2003-2006 | MEG/CR | HOND-21P | TPX8+ | TPX8+ | TP08 | 4 |
| | RODEO | 2006-2008 | MEG/CR | HOND-21P | TPX8+ | TPX8+ | TP08 | 4 |
| IVECO® | DAILY | 1998-2006 | PHI/CR2 | FI-11P5 | TPX4/TPX5 | TPX4/TPX5 | TP12 | 19 |
| | | 1998-2006 | PHI/CR2 | ORIGINAL | | | - | |
| | | 2006-2011 | MEG/CR | FI-11P5 | TPX8+ | TPX8+ | TP08 | 19 |
| | | 2012- | PHI/CR2 | FI-16P | TPX4/TPX5 | TPX4/TPX5 | TP12 | 20 |
| | | 2012- | PHI/CR2 | ORIGINAL | | | - | |
| JAGUAR® | F-PACE | 2016- | PHI/CR3 | DEALER KEY | | | - | |
| | F-TYPE | 2013- | PHI/CR3 | DEALER KEY | | | - | |
| | SOVEREIGN | 1996-2000 | MEG/- | JAU-1P | TP05 | TP05 | TP03/TP05** | 18 |
| | S-TYPE | 1999-2000 | TEX/CR | JAU-2P | TPX2/TPX5/TPX6 | TPX2/TPX5/TPX6 | TP06 | 18 |
| | | 2000-2008 | TEX/CR | FO-6P | TPX2/TPX5/TPX6 | TPX2/TPX5/TPX6 | TP06 | 6 |
| | XE | 2015- | PHI/CR3 | DEALER KEY | | | - | |
| | XF | 2008-2012 | PHI/CR2 | DEALER KEY | | | - | |
| | | 2012- | PHI/CR3 | DEALER KEY | | | - | |
| | XJ | 1998-2000 | MEG/- | JAU-1P | TP05 | TP05 | TP03/TP05** | 18 |
| | | 2003-2009 | TEX/CR | FO-6P | TPX2/TPX5/TPX6 | TPX2/TPX5/TPX6 | TP06 | 6 |
| | | 2009-2012 | PHI/CR2 | DEALER KEY | | | - | |
| | | 2012- | PHI/CR3 | DEALER KEY | | | - | |
| | XJS | 1998- | MEG/- | JAU-1P | TP05 | TP05 | TP03/TP05** | 18 |
| | XK | 2006-2012 | PHI/CR2 | DEALER KEY | | | - | |
| | | 2012-2014 | PHI/CR3 | DEALER KEY | | | - | |
| | XK8 | 1998-2006 | MEG/- | JAU-1P | TP05 | TP05 | TP03/TP05** | 18 |
| XKR | 2007-2014 | PHI/CR2 | DEALER KEY | TPX4/TPX5 | TPX4/TPX5 | - | | |
| X-TYPE | 2000-2008 | TEX/CR | FO-6P | TPX2/TPX5/TPX6 | TPX2/TPX5/TPX6 | TP06 | 6 | |
| JAGUAR® (USA) | S-TYPE | 2000-2008 | TEX/CR | JAU-2P | TPX2/TPX5/TPX6 | TPX2/TPX5/TPX6 | TP06 | 18 |
| | XJ/XK/XK8/XKR | 1998-1999 | MEG/- | JAU-1P | TP05 | TP05 | TP03/TP05** | 18 |
| | | 2000-2008 | MEG/- | DEALER KEY | | | - | |
| | XJ8 / XJR | 1998-1999 | MEG/- | JAU-1P | TPX2/TPX5/TPX6 | TPX2/TPX5/TPX6 | TP06 | 18 |
| | | 2000-2003 | MEG/CR | JAU-1P | TPX8+ | TPX8+ | TP08 | 18 |
| | | 2004-2009 | TEX/CR | JAU-2P | TPX2/TPX5/TPX6 | TPX2/TPX5/TPX6 | TP06 | 18 |
| | XX8 / XKR | 2007-2014 | MEG/CR | DEALER KEY | | | - | |
| | X-TYPE | 1999-2003 | TEX/CR | JAU-2P | TPX2/TPX5/TPX6 | TPX2/TPX5/TPX6 | TP06 | 18 |
| | | 2002-2008 | TEX/CR | JAU-2P | TPX2/TPX5/TPX6 | TPX2/TPX5/TPX6 | TP20 | 18 |

AUTOMÓVIL - CAMIONETA





CAR-PICK UP TRUCK





| FOR: |  |  |  |  | TRS-5000 EVO | EVO XPERT | Programming TP |  |
|----------|---|---|---|---|-----------------|----------------|-------------------|---|
| JEEP® | CHEROKEE | 1998-2004 | TEX/CR | CHR-15P | TPX2/TPX5/TPX6 | TPX2/TPX5/TPX6 | TP21 | 1 |
| | | 2005-2013 | PHI/CR2 | CHR-15P | TPX4/TPX5 | TPX4/TPX5 | TP12CH | 1 |
| | CJ5 / CJ7 | 1998-2005 | TEX/CR | CHR-15P | TPX2/TPX5/TPX6 | TPX2/TPX5/TPX6 | TP21 | 1 |
| | | 2006- | PHI/CR2 | CHR-15P | TPX4/TPX5 | TPX4/TPX5 | TP12CH | 1 |
| | COMANCHE | 2006- | PHI/CR2 | CHR-15P | TPX4/TPX5 | TPX4/TPX5 | TP12CH | 1 |
| | COMMANDER | 2006-2007 | PHI/CR2 | CHR-15P | TPX4/TPX5 | TPX4/TPX5 | TP12CH | 1 |
| | | 2008-2010 | PHI/CR2 | CHR-15P1 | TPX4/TPX5 | TPX4/TPX5 | - | 1 |
| | COMPASS | 2007-2018 | PHI/CR2 | CHR-15P | TPX4/TPX5 | TPX4/TPX5 | TP12CH | 1 |
| | G.CHEROKEE | 1998-2004 | TEX/CR | CHR-15P | TPX2/TPX5/TPX6 | TPX2/TPX5/TPX6 | TP21 | 1 |
| | | 2005-2008 | PHI/CR2 | CHR-15P | TPX4/TPX5 | TPX4/TPX5 | TP12CH | 1 |
| | | 2009-2013 | PHI/CR2 | CHR-15P1 | TPX4/TPX5 | TPX4/TPX5 | TP12CH | 1 |
| | | 2014- | PHI/CR3 | DEALER KEY | | | - | |
| | LIBERTY | 2002-2004 | TEX/CR | CHR-15P | TPX2/TPX5/TPX6 | TPX2/TPX5/TPX6 | TP21 | 1 |
| | | 2005-2013 | PHI/CR2 | CHR-15P | TPX4/TPX5 | TPX4/TPX5 | TP12CH | 1 |
| | PATRIOT | 2007-2018 | PHI/CR2 | CHR-15P | TPX4/TPX5 | TPX4/TPX5 | TP12CH | 1 |
| | RENEGADE | 2015- | MEG/AES | ORIGINAL | | | - | |
| 2015- | | PHI/CR3 | DEALER KEY | | | - | | |
| WRANGLER | 1998-2006 | TEX/CR | CHR-15P | TPX2/TPX5/TPX6 | TPX2/TPX5/TPX6 | TP21 | 1 | |
| | 2007- | PHI/CR2 | CHR-15P | TPX4/TPX5 | TPX4/TPX5 | TP12CH | 1 | |
| KIA® | AMANTI | 2004-2006 | TEX/CR | KI-9P | TPX2/TPX5/TPX6 | TPX2/TPX5/TPX6 | TP19 | 13 |
| | | 2007-2009 | PHI/CR2 | KI-9P | TPX4/TPX5 | TPX4/TPX5 | TP12 | 13 |
| | BORREGO | 2009-2011 | PHI/CR2 | HY-18P | TPX4/TPX5 | TPX4/TPX5 | TP12 | 11 |
| | | 2009-2011 | PHI/CR2 | DEALER KEY | | | - | |
| | CADENZA | 2009- | PHI/CR2 | ORIGINAL | | | - | |
| | | 2013- | PHI/CR2 | DEALER KEY | | | - | |
| | CARENS | 2001-2006 | TEX/CR | KI-2DP | TPX2/TPX5/TPX6 | TPX2/TPX5/TPX6 | TP19 | 13 |
| | | 2001-2006 | PHI/CR2 | KI-2DP | TPX4/TPX5 | TPX4/TPX5 | TP12 | 13 |
| | | 2006-2012 | PHI/CR2 | HY-11P1 | TPX4/TPX5 | TPX4/TPX5 | TP12 | 11 |
| | | 2013- | PHI/CR2 | DEALER KEY | | | - | |
| | | 2013- | TEX/DST80 | HY-18P | TPX7 | TPX7 | TP46 | 11 |
| | CARNIVAL | 1999-2000 | MEG/CR | KI-2DP | TPM1 | TPM1 | TP08 | 13 |
| | | 2000-2002 | TEX/CR | KI-2DP | TPX2/TPX5/TPX6 | TPX2/TPX5/TPX6 | TP19 | 13 |
| | | 2002-2005 | PHI/CR2 | KI-2DP | TPX4/TPX5 | TPX4/TPX5 | TP12 | 13 |
| | | 2006-2014 | PHI/CR2 | HY-11P1 | TPX4/TPX5 | TPX4/TPX5 | TP12 | 11 |
| | | 2014- | TEX/DST80 | HY-11P1 | TPX7 | TPX7 | TP46 | 11 |
| CEE'D | 2006-2010 | PHI/CR2 | KI-9P | TPX4/TPX5 | TPX4/TPX5 | TP12 | 13 | |
| | 2010-2012 | PHI/CR2 | HY-18RKE | TPX4/TPX5 | TPX4/TPX5 | - | 12 | |
| | 2010-2012 | PHI/CR2 | HY-18P | TPX4/TPX5 | TPX4/TPX5 | TP12 | 11 | |
| | 2012-2018 | TEX/DST80 | HY-18P | TPX7 | TPX7 | TP46 | 11 | |
| | 2012- | PHI/CR2 | DEALER KEY | | | - | | |
| CEE'D SW | 2006-2010 | PHI/CR2 | KI-9P | TPX4/TPX5 | TPX4/TPX5 | TP12 | 13 | |
| | 2010-2012 | PHI/CR2 | HY-18P | TPX4/TPX5 | TPX4/TPX5 | TP12 | 11 | |
| CERATO | 2004-2009 | PHI/CR2 | KI-2P | TPX4/TPX5 | TPX4/TPX5 | TP12 | 13 | |
| | 2004- | PHI/CR2 | ORIGINAL | | | - | | |
| | 2013- | TEX/DST80 | HY-11DP1 | TPX7 | TPX7 | TP46 | 11 | |
| CLARUS | 1998-2001 | MEG/- | KI-2DP | TP05 | TP05 | TP03/TP05** | 13 | |
| | 1998-2001 | MEG/- | KI-2P | TP05 | TP05 | TP03/TP05** | 13 | |
| | 1998-2001 | MEG/CR | KI-2DP | TPM1 | TPM1 | TP08 | 13 | |
| | 1998-2001 | MEG/CR | ORIGINAL | | | - | | |
| JOICE | 2000-2003 | TEX/CR | KI-2DP | TPX2/TPX5/TPX6 | TPX2/TPX5/TPX6 | TP19 | 13 | |

| FOR: |  |  |  |  | TRS-5000 EVO | EVO XPERT | Programming TP |  |
|----------|---|---|---|---|-----------------|----------------|-------------------|---|
| K900 | 2014-2016 | PHI/CR2 | DEALER KEY | | | | - | |
| MAGENTIS | 2001-2006 | PHI/CR2 | KI-2DP | | TPX4/TPX5 | TPX4/TPX5 | TP12 | 13 |
| | 2006-2008 | PHI/CR2 | HY-11DP1 | | TPX4/TPX5 | TPX4/TPX5 | TP12 | 11 |
| | 2009-2011 | PHI/CR2 | HY-18P | | TPX4/TPX5 | TPX4/TPX5 | TP12 | 11 |
| MENTOR | 2002-2004 | PHI/CR2 | KI-2DP | | TPX4/TPX5 | TPX4/TPX5 | TP12 | 13 |
| MORNING | 2006-2011 | PHI/CR2 | HY-4P1 | | TPX4/TPX5 | TPX4/TPX5 | TP12 | 11 |
| | 2011- | PHI/CR2 | DEALER KEY | | | | - | |
| | 2011- | TEX/DST80 | HY-19DP1 | | TPX7 | TPX7 | TP46 | 12 |
| NIRO | 2016- | TEX/DST80 | HY-20P1 | | TPX7 | TPX7 | - | 12 |
| OPIRUS | 2003-2006 | PHI/CR2 | KI-9P | | TPX4/TPX5 | TPX4/TPX5 | TP12 | 13 |
| | 2007-2010 | PHI/CR2 | HY-18P | | TPX4/TPX5 | TPX4/TPX5 | TP12 | 11 |
| OPTIMA | 2001-2006 | PHI/CR2 | KI-2DP | | TPX4/TPX5 | TPX4/TPX5 | TP12 | 13 |
| | 2006-2010 | PHI/CR2 | HY-11P1 | | TPX4/TPX5 | TPX4/TPX5 | TP12 | 11 |
| | 2010-2014 | PHI/CR2 | HY-18P | | TPX4/TPX5 | TPX4/TPX5 | TP12 | 11 |
| PICANTO | 2004-2008 | PHI/CR2 | HY-4P1 | | TPX4/TPX5 | TPX4/TPX5 | TP12 | 11 |
| | 2007-2011 | PHI/CR2 | KI-9P | | TPX4/TPX5 | TPX4/TPX5 | TP12 | 13 |
| | 2011- | PHI/CR2 | DEALER KEY | | | | - | |
| | 2011- | TEX/DST80 | HY-19DP1 | | TPX7 | TPX7 | TP46 | 12 |
| | 2017- | TEX/DST80 | HY-20P1 | | TPX7 | TPX7 | - | 12 |
| PRIDE | 1999-2001 | MEG/CR | KI-2DP | | TPM1 | TPM1 | TP08 | 13 |
| RETONA | 1998-2003 | MEG/CR | KI-2DP | | TPM1/TPX8+ | TPM1/TPX8+ | TP08 | 13 |
| | 1999-2003 | TEX/CR | KI-2DP | | TPX2/TPX5/TPX6 | TPX2/TPX5/TPX6 | TP19 | 13 |
| RIO | 2001-2005 | TEX/CR | KI-2DP | | TPX2/TPX5/TPX6 | TPX2/TPX5/TPX6 | TP19 | 13 |
| | 2006-2009 | PHI/CR2 | HY-12P1 | | TPX4/TPX5 | TPX4/TPX5 | TP12 | 11 |
| | 2009-2011 | PHI/CR2 | HY-18P | | TPX4/TPX5 | TPX4/TPX5 | TP12 | 11 |
| | 2012-2017 | PHI/CR2 | HY-20P1 | | TPX4/TPX5 | TPX4/TPX5 | TP12 | 12 |
| | 2012-2017 | PHI/CR2 | DEALER KEY | | | | - | |
| | 2012-2017 | TEX/DST80 | HY-18P | | TPX7 | TPX7 | TP46 | 11 |
| | 2017- | TEX/DST80 | HY-20P1 | | TPX7 | TPX7 | - | 12 |
| RONDO | 2001-2006 | TEX/CR | KI-2DP | | TPX2/TPX5/TPX6 | TPX2/TPX5/TPX6 | TP19 | 13 |
| | 2007-2010 | PHI/CR2 | HY-11DP1 | | TPX4/TPX5 | TPX4/TPX5 | TP12 | 11 |
| | 2011-2013 | PHI/CR2 | KI-7P | | TPX4/TPX5 | TPX4/TPX5 | TP12 | 13 |
| | 2011-2013 | PHI/CR2 | KI-9P | | TPX4/TPX5 | TPX4/TPX5 | TP12 | 13 |
| | 2013- | TEX/DST80 | HY-18P | | TPX7 | TPX7 | TP46 | 11 |
| SEDONA | 1999-2000 | MEG/CR | KI-2DP | | TPM1 | TPM1 | TP08 | 13 |
| | 2002-2005 | PHI/CR2 | KI-2DP | | TPX4/TPX5 | TPX4/TPX5 | TP12 | 13 |
| | 2006-2014 | PHI/CR2 | HY-11P1 | | TPX4/TPX5 | TPX4/TPX5 | TP12 | 11 |
| SEPHIA | 1997-2003 | MEG/- | KI-2DP | | TP05 | TP05 | TP03/TP05** | 13 |
| | 1997-2003 | MEG/CR | KI-2DP | | TPM1/TPX8+ | TPM1/TPX8+ | TP08 | 13 |
| | 1997-2003 | TEX/CR | KI-2DP | | TPX2/TPX5/TPX6 | TPX2/TPX5/TPX6 | TP06 | 13 |
| | 2002-2004 | PHI/CR2 | KI-2DP | | TPX4/TPX5 | TPX4/TPX5 | TP12 | 13 |
| SHUMA | 1998-2001 | MEG/- | KI-2DP | | TP05 | TP05 | TP03/TP05** | 13 |
| | 1998-2001 | MEG/CR | KI-2DP | | TPM1 | TPM1 | TP08 | 13 |
| | 2000-2003 | TEX/CR | KI-2DP | | TPX2/TPX5/TPX6 | TPX2/TPX5/TPX6 | TP19 | 13 |
| SORENTO | 2002-2009 | PHI/CR2 | HY-6DP1 | | TPX4/TPX5 | TPX4/TPX5 | TP12 | 11 |
| | 2009-2014 | PHI/CR2 | KI-9P | | TPX4/TPX5 | TPX4/TPX5 | TP12 | 13 |
| | 2010-2012 | PHI/CR2 | HY-18RKE | | TPX4/TPX5 | TPX4/TPX5 | - | 12 |
| | 2015- | TEX/DST80 | HY-19P1 | | TPX7 | TPX7 | TP46 | 12 |
| | 2015- | PHI/CR2 | DEALER KEY | | | | - | |
| SOUL | 2009-2013 | PHI/CR2 | HY-11DP1 | | TPX4/TPX5 | TPX4/TPX5 | TP12 | 11 |

AUTOMÓVIL - CAMIONETA



CAR-PICK UP TRUCK





| FOR: |  |  |  |  | TRS-5000 EVO | EVO XPERT | Programming TP |  |
|---------------------|---|---|---|---|-----------------|----------------|-------------------|---|
| | | 2014- | TEX/DST80 | HY-18P | TPX7 | TPX7 | TP46 | 11 |
| | | 2014- | TEX/AES | DEALER KEY | | | - | |
| | SPECTRA | 2005-2009 | PHI/CR2 | ORIGINAL | | | - | |
| | SPORTAGE | 1995-1998 | MEG/- | KI-2DP | TP05 | TP05 | TP03/TP05** | 13 |
| | | 1999-2001 | MEG/CR | KI-2DP | TPM1 | TPM1 | TP08 | 13 |
| | | 2001-2003 | TEX/CR | KI-2DP | TPX2/TPX5/TPX6 | TPX2/TPX5/TPX6 | TP19 | 13 |
| | | 2006-2010 | PHI/CR2 | HY-4P1 | TPX4/TPX5 | TPX4/TPX5 | TP12 | 11 |
| | | 2010-2015 | PHI/CR2 | HY-18P | TPX4/TPX5 | TPX4/TPX5 | TP12 | 11 |
| | | 2010-2015 | PHI/CR2 | HY-11DP1 | TPX4/TPX5 | TPX4/TPX5 | TP12 | 11 |
| | | 2015- | TEX/DST80 | HY-18P | TPX7 | TPX7 | TP46 | 11 |
| | STONIC | 2017- | TEX/DST80 | HY-20P1 | TPX7 | TPX7 | - | 12 |
| | | 2017- | TEX/AES | DEALER KEY | | | - | |
| KIA® (USA) | VENGA | 2010- | PHI/CR2 | DEALER KEY | TPX4/TPX5 | TPX4/TPX5 | TP12 | |
| | AMANTI | 2004-2006 | TEX/CR | KI-7P | TPX2/TPX5/TPX6 | TPX2/TPX5/TPX6 | TP19 | 13 |
| | | 2007-2009 | PHI/CR2 | KI-9P | TPX4/TPX5 | TPX4/TPX5 | TP12 | 13 |
| | BORREGO | 2009-2011 | PHI/CR2 | HY-18P | TPX4/TPX5 | TPX4/TPX5 | TP12 | 11 |
| | | 2009-2011 | PHI/CR2 | DEALER KEY | | | - | |
| | FORTE (CANADA) | 2010-2013 | PHI/CR2 | HY-11DP1 | TPX4/TPX5 | TPX4/TPX5 | TP12 | 11 |
| | FORTE | 2013-2015 | PHI/CR2 | DEALER KEY | | | - | |
| | | 2014- | TEX/DST80 | HY-11DP1 | TPX7 | TPX7 | TP46 | 11 |
| | MAGENTIS (CAN) | 2001-2006 | PHI/CR2 | HY-11DP1 | TPX4/TPX5 | TPX4/TPX5 | TP12 | 11 |
| | | 2009-2011 | PHI/CR2 | HY-18P | TPX4/TPX5 | TPX4/TPX5 | TP12 | 11 |
| | OPTIMA (CANADA) | 2001-2006 | PHI/CR2 | HY-11DP1 | TPX4/TPX5 | TPX4/TPX5 | TP12 | 11 |
| | | 2010-2014 | PHI/CR2 | HY-18P | TPX4/TPX5 | TPX4/TPX5 | TP12 | 11 |
| | OPTIMA w/PROX | 2010-2015 | PHI/CR2 | DEALER KEY | | | - | |
| | | 2016- | PHI/CR2 | DEALER KEY | | | - | |
| | RIO (CANADA) | 2006-2009 | PHI/CR2 | HY-12P1 | TPX4/TPX5 | TPX4/TPX5 | TP12 | 11 |
| | | 2010-2011 | PHI/CR2 | HY-18P | TPX4/TPX5 | TPX4/TPX5 | TP12 | 11 |
| | | 2012-2017 | TEX/DST80 | HY-18P | TPX7 | TPX7 | TP46 | 11 |
| | RIO | 2011-2015 | PHI/CR2 | DEALER KEY | | | - | |
| | RONDO (CANADA) | 2011-2013 | PHI/CR2 | HY-18P | TPX4/TPX5 | TPX4/TPX5 | TP12 | 11 |
| | SEDONA (CANADA) | 2002-2005 | TEX/CR | HY-11DP1 | TPX4/TPX5 | TPX4/TPX5 | TP12 | 11 |
| | | 2006-2009 | PHI/CR2 | HY-11DP1 | TPX4/TPX5 | TPX4/TPX5 | TP12 | 11 |
| | SORENTO (CANADA) | 2002-2009 | PHI/CR2 | HY-6DP1 | TPX4/TPX5 | TPX4/TPX5 | TP12 | 11 |
| | | 2010-2011 | PHI/CR2 | KI-9P | TPX4/TPX5 | TPX4/TPX5 | TP12 | |
| | SORENTO | 2011-2015 | PHI/CR2 | DEALER KEY | | | - | |
| | SOUL | 2011-2013 | PHI/CR2 | DEALER KEY | | | - | |
| | | 2014- | PHI/CR2 | DEALER KEY | | | - | |
| | SPORTAGE (CANADA) | 2010-2011 | PHI/CR2 | HY-18P | TPX4/TPX5 | TPX4/TPX5 | TP12 | 11 |
| | SPORTAGE | 2011-2013 | PHI/CR2 | DEALER KEY | | | - | |
| LAMBORGHINI® | GALLARDO | 2003-2013 | MEG/CR | HU-HAAP1 | TPX8+ | TPX8+ | TP08 | 7 |
| | MURCIELAGO | -2010 | MEG/CR | HU-HAAP1 | TPX8+ | TPX8+ | TP08 | 7 |
| LANCIA® | DEDRA | 1995-1997 | MEG/- | FI-13P4 | TP05 | TP05 | TP03/TP05** | 20 |
| | | 1997-1999 | TEM/- | FI-13P4 | TP05 | TP05 | TP04/TP05** | 20 |
| | DELTA | 1995-1999 | MEG/- | FI-13P4 | TP05 | TP05 | TP03/TP05** | 20 |
| | | 2008-2010 | MEG/CR | FI-16P | TPX8+ | TPX8+ | TP08 | 20 |
| | | 2008-2010 | MEG/CR | ORIGINAL | | | - | |
| | | 2008-2014 | PHI/CR2 | FI-16P | TPX4/TPX5 | TPX4/TPX5 | TP12 | 20 |
| | K | 1995-2001 | PHI/- | SIP-4P4 | TP01 | TP01 | TP01/TP05** | 20 |
| | LYBRA | 1999-2006 | MEG/CR | FI-16P | TPX8+ | TPX8+ | TP08 | 20 |

| FOR: |  |  |  |  | TRS-5000 EVO | EVO XPERT | Programming TP |  |
|---|---|---|---|---|-----------------|----------------|-------------------|---|
| | MUSA | 2004-2009 | MEG/CR | FI-16P | TPX8+ | TPX8+ | TP08 | 20 |
| | | 2009-2012 | PHI/CR2 | FI-16P | TPX4/TPX5 | TPX4/TPX5 | TP12 | 20 |
| | PHEDRA | 2002-2010 | PHI/CR2 | HU-HCAP | TPX4/TPX5 | TPX4/TPX5 | TP12 | 8 |
| | THESIS | 2002-2009 | MEG/CR | FI-16P | TPX8+ | TPX8+ | TP08 | 20 |
| | Y | 1995-2003 | TEM/- | FI-13P4 | TP05 | TP05 | TP04/TP05** | 20 |
| | YPSILON | 2003-2011 | MEG/CR | FI-16P | TPX8+ | TPX8+ | TP08 | 20 |
| | | 2011- | PHI/CR2 | FI-16P | TPX4/TPX5 | TPX4/TPX5 | TP12 | 20 |
| 2011- | | PHI/CR2 | ORIGINAL | | | - | | |
| Z 2000 | 1998- | PHI/- | SIX-3P3 | TP01 | TP01 | TP01/TP05** | 16 | |
| LAND-RANGE ROVER[®] | 4.0 / 4.6 SE | 1995-2003 | PHI/- | NE-35P3 | | | - | 5 |
| | | 1995- | -/- | ORIGINAL | | | - | |
| | DEFENDER | 1995-2003 | -/- | NE-52P2 | | | - | 15 |
| | DISCOVERY | 1995-1998 | PHI/- | NE-35P3 | | | - | 5 |
| | DISCOVERY 3 | 2006-2009 | PHI/CR2 | FO-24P | TPX4/TPX5 | TPX4/TPX5 | TP12 | 6 |
| | DISCOVERY 4 | 2010-2012 | PHI/CR3 | DEALER KEY | | | - | |
| | | 2012- | PHI/CR3 | DEALER KEY | | | - | |
| | DISCOVERY 5 | 2017- | PHI/CR3 | DEALER KEY | | | - | |
| | EVOQUE | 2011- | PHI/CR3 | DEALER KEY | | | - | |
| | | 2018- | PHI/CR3 | DEALER KEY | | | - | |
| | FREELANDER | 1998-2003 | PHI/EVO. | ORIGINAL | | | - | |
| | | 2003-2006 | PHI/CR2 | NE-52P2 | TPX4/TPX5 | TPX4/TPX5 | - | 15 |
| | FREELANDER 2 | 2006-2012 | PHI/CR2 | DEALER KEY | | | - | |
| | FREELANDER 3 | 2013- | PHI/CR3 | DEALER KEY | | | - | |
| | RANGE ROVER | 1995-2003 | PHI/EVO. | ORIGINAL | | | - | |
| | | 2003-2005 | PHI/CR2 | BM-6P | TPX4/TPX5 | TPX4/TPX5 | TP12 | 5 |
| | RANGE ROVER SPORT | 2006-2009 | PHI/CR2 | FO-24P | TPX4/TPX5 | TPX4/TPX5 | TP12 | 6 |
| 2009-2011 | | PHI/CR3 | DEALER KEY | | | - | | |
| 2010- | | PHI/CR3 | DEALER KEY | | | - | | |
| RANGE ROVER VOGUE | 2006-2010 | PHI/CR2 | BM-6P | TPX4/TPX5 | TPX4/TPX5 | TP12 | 5 | |
| | 2009-2011 | PHI/CR3 | DEALER KEY | | | - | | |
| | 2010- | PHI/CR3 | DEALER KEY | | | - | | |
| LAND-RANGE ROVER[®] (USA) | FREELANDER | 2002-2005 | PHI/CR2 | NE-52P2 | TPX4/TPX5 | TPX4/TPX5 | TP12 | 15 |
| | LR2 | 2005-2009 | PHI/CR2 | DEALER KEY | | | - | |
| | LR3 | 2005-2009 | PHI/CR2 | DEALER KEY | | | - | |
| | LR4 | 2010-2014 | PHI/CR2 | DEALER KEY | | | - | |
| | RANGE ROVER | 2003-2006 | PHI/CR2 | BM-6P6 | TPX4/TPX5 | TPX4/TPX5 | TP12 | 6 |
| 2003-2009 | | PHI/CR2 | DEALER KEY | | | - | | |
| 2007-2009 | | PHI/CR2 | FO-24P | | | - | 6 | |
| LEXUS[®] (TOYOTA[®]) | CT200H | 2011- | TEX/CR | DEALER KEY | | | - | |
| | ES300 | 1998-2001 | TEX/- | TOYO-18P | TPX1/TPX6/TPX5 | TPX1/TPX6/TPX5 | TP07 | 18 |
| | | 2002-2003 | TEX/- | TOYO-30P | TPX1/TPX6/TPX5 | TPX1/TPX6/TPX5 | TP07 | 19 |
| | | 2002-2003 | TEX/- | TOYO-36P | TPX1/TPX6/TPX5 | TPX1/TPX6/TPX5 | TP07 | 19 |
| | ES300h | 2013- | TEX/AES | DEALER KEY | | | - | |
| | ES330 | 2004-2006 | TEX/CR | TOYO-30P | TPX2/TPX5/TPX6 | TPX2/TPX5/TPX6 | TP29 | 19 |
| | | 2004-2006 | TEX/CR | TOYO-36P | TPX2/TPX5/TPX6 | TPX2/TPX5/TPX6 | TP29 | 19 |
| ES350 | 2007-2008 | TEX/CR | DEALER KEY | | | - | | |
| | 2009-2012 | TEX/CR | DEALER KEY | | | - | | |
| | 2013- | TEX/AES | DEALER KEY | | | - | | |

AUTOMÓVIL - CAMIONETA





CAR-PICK UP TRUCK





| FOR: |  |  |  |  | TRS-5000 EVO | EVO XPERT | Programming TP |  |
|-----------|---|---|---|---|-----------------|----------------|-------------------|---|
| GS SERIES | 1998-2005 | TEX/- | TOYO-30P | | TPX1/TPX6/TPX5 | TPX1/TPX6/TPX5 | TP07 | 19 |
| | 1998-2005 | TEX/- | TOYO-36P | | TPX1/TPX6/TPX5 | TPX1/TPX6/TPX5 | TP07 | 19 |
| GS300 | 1998-2005 | TEX/- | TOYO-30P | | TPX1/TPX6/TPX5 | TPX1/TPX6/TPX5 | TP07 | 19 |
| | 2006-2008 | TEX/CR | TOYO-30P | | TPX2/TPX5/TPX6 | TPX2/TPX5/TPX6 | TP29 | 19 |
| | 2006-2008 | TEX/CR | DEALER KEY | | | | - | |
| GS350 | 2006-2013 | TEX/CR | DEALER KEY | | | | - | |
| | 2013- | TEX/AES | DEALER KEY | | | | - | |
| GS400 | 1998-2001 | TEX/- | TOYO-30P | | TPX1/TPX6/TPX5 | TPX1/TPX6/TPX5 | TP07 | 19 |
| GS430 | 2001-2005 | TEX/- | TOYO-30P | | TPX1/TPX6/TPX5 | TPX1/TPX6/TPX5 | TP07 | 19 |
| | 2006-2008 | TEX/CR | DEALER KEY | | | | - | |
| | GS450H | 2006-2012 | TEX/CR | | DEALER KEY | | - | - |
| | 2013- | TEX/AES | DEALER KEY | | | | - | |
| GS460 | 2008-2011 | TEX/CR | DEALER KEY | | | | - | |
| GX460 | 2003-2009 | TEX/CR | TOYO-30P | | TPX2/TPX5/TPX6 | TPX2/TPX5/TPX6 | TP29 | 19 |
| | 2008- | TEX/CR | DEALER KEY | | | | - | |
| GX470 | 2003-2006 | TEX/CR | TOYO-30P | | TPX2/TPX5/TPX6 | TPX2/TPX5/TPX6 | TP29 | 19 |
| | 2003-2009 | TEX/CR | TOYO-36P | | TPX2/TPX5/TPX6 | TPX2/TPX5/TPX6 | TP29 | 19 |
| HS250H | 2010-2013 | TEX/CR | DEALER KEY | | | | - | |
| IS200 | 1999-2005 | TEX/- | TOYO-30P | | TPX1/TPX6/TPX5 | TPX1/TPX6/TPX5 | TP07 | 19 |
| | 1999-2005 | TEX/- | TOYO-36P | | TPX1/TPX6/TPX5 | TPX1/TPX6/TPX5 | TP07 | 19 |
| IS220D | 2006-2013 | TEX/CR | DEALER KEY | | | | TP29 | |
| | 2006-2013 | TEX/CR | ORIGINAL | | | | TP29 | |
| IS250 | 2006-2008 | TEX/CR | DEALER KEY | | | | - | |
| | 2009-2012 | TEX/CR | DEALER KEY | | | | - | |
| | 2013- | TEX/AES | DEALER KEY | | | | - | |
| IS300 | 2001-2005 | TEX/- | TOYO-30P | | TPX1/TPX6/TPX5 | TPX1/TPX6/TPX5 | TP07 | 19 |
| | 2001-2005 | TEX/- | TOYO-36P | | TPX1/TPX6/TPX5 | TPX1/TPX6/TPX5 | TP07 | 19 |
| IS350 | 2006-2008 | TEX/CR | DEALER KEY | | | | - | |
| | 2013- | TEX/AES | DEALER KEY | | | | - | |
| ISF | 2009-2012 | TEX/CR | DEALER KEY | | | | - | |
| | 2013-2015 | TEX/AES | DEALER KEY | | | | - | |
| LS200 | 1999-2005 | TEX/- | TOYO-30P | | TPX1/TPX6/TPX5 | TPX1/TPX6/TPX5 | TP07 | 19 |
| | 1999-2005 | TEX/- | TOYO-36P | | TPX1/TPX6/TPX5 | TPX1/TPX6/TPX5 | TP07 | 19 |
| LS400 | 1997-2000 | TEX/- | TOYO-18P | | TPX1/TPX6/TPX5 | TPX1/TPX6/TPX5 | TP07 | 18 |
| | 1998-2000 | TEX/- | TOYO-30P | | TPX1/TPX6/TPX5 | TPX1/TPX6/TPX5 | TP07 | 19 |
| | 1998-2000 | TEX/- | TOYO-36P | | TPX1/TPX6/TPX5 | TPX1/TPX6/TPX5 | TP07 | 19 |
| LS430 | 2001-2006 | TEX/CR | TOYO-30P | | TPX2/TPX5/TPX6 | TPX2/TPX5/TPX6 | TP29 | 19 |
| | 2001-2006 | TEX/CR | TOYO-36P | | TPX2/TPX5/TPX6 | TPX2/TPX5/TPX6 | TP29 | 19 |
| | 2004-2006 | TEX/CR | DEALER KEY | | | | - | |
| LS460 | 2007-2012 | TEX/CR | DEALER KEY | | | | - | |
| | 2013-2017 | TEX/AES | DEALER KEY | | | | - | |
| LS600 | 2007-2008 | TEX/CR | DEALER KEY | | | | - | |
| LS600h | 2010-2013 | TEX/CR | DEALER KEY | | | | - | |
| LX450 | 1998-1998 | TEX/- | TOYO-18P | | TPX1/TPX6/TPX5 | TPX1/TPX6/TPX5 | TP07 | 18 |
| LX460 | 2007-2008 | TEX/CR | ORIGINAL | | | | - | |
| LX470 | 1998-2000 | TEX/- | TOYO-18P | | TPX1/TPX6/TPX5 | TPX1/TPX6/TPX5 | TP07 | 18 |
| | 2001-2002 | TEX/- | TOYO-30P | | TPX1/TPX6/TPX5 | TPX1/TPX6/TPX5 | TP07 | 19 |
| | 2003-2008 | TEX/CR | TOYO-30P | | TPX2/TPX5/TPX6 | TPX2/TPX5/TPX6 | TP29 | 19 |
| | 2003-2008 | TEX/CR | TOYO-36P | | TPX2/TPX5/TPX6 | TPX2/TPX5/TPX6 | TP29 | 19 |
| LX570 | 2008-2015 | TEX/CR | DEALER KEY | | | | - | |

| FOR: |  |  |  |  | TRS-5000 EVO | EVO XPERT | Programming TP |  |
|---|---|---|---|---|-----------------|----------------|-------------------|---|
| | NX200t | 2015- | TEX/AES | DEALER KEY | | | - | |
| | NX300h | 2015- | TEX/AES | DEALER KEY | | | - | |
| | RX300 | 1997-2003 | TEX/- | TOYO-30P | TPX1/TPX6/TPX5 | TPX1/TPX6/TPX5 | TP07 | 19 |
| | | 1997-2003 | TEX/- | TOYO-36P | TPX1/TPX6/TPX5 | TPX1/TPX6/TPX5 | TP07 | 19 |
| | RX330 | 2004-2009 | TEX/CR | TOYO-30P | TPX2/TPX5/TPX6 | TPX2/TPX5/TPX6 | TP29 | 19 |
| | | 2004-2009 | TEX/CR | TOYO-36P | TPX2/TPX5/TPX6 | TPX2/TPX5/TPX6 | TP29 | 19 |
| | RX350 | 2004-2011 | TEX/CR | TOYO-30P | TPX2/TPX5/TPX6 | TPX2/TPX5/TPX6 | TP29 | 19 |
| | | 2004-2011 | TEX/CR | TOYO-36P | TPX2/TPX5/TPX6 | TPX2/TPX5/TPX6 | TP29 | 19 |
| | | 2010-2015 | TEX/CR | DEALER KEY | | | - | |
| | RX400H | 2004-2009 | TEX/CR | TOYO-30P | TPX2/TPX5/TPX6 | TPX2/TPX5/TPX6 | TP29 | 19 |
| | | 2005-2009 | TEX/CR | TOYO-36P | TPX2/TPX5/TPX6 | TPX2/TPX5/TPX6 | TP29 | 19 |
| | | 2010- | TEX/CR | DEALER KEY | | | - | |
| | RX450H | 2010- | TEX/CR | TOYO-30P | TPX2/TPX5/TPX6 | TPX2/TPX5/TPX6 | TP29 | 18 |
| | | 2010- | TEX/CR | TOYO-36P | TPX2/TPX5/TPX6 | TPX2/TPX5/TPX6 | TP29 | 19 |
| | | 2011- | TEX/CR | DEALER KEY | | | - | |
| | SC300/400 | 1998-2006 | TEX/- | TOYO-18P | TPX1/TPX6/TPX5 | TPX1/TPX6/TPX5 | TP07 | 18 |
| | SC430 | 2002-2011 | TEX/CR | TOYO-36P | TPX2/TPX5/TPX6 | TPX2/TPX5/TPX6 | TP29 | 19 |
| LEXUS[®] (TOYOTA[®]) (JAPON) | ALTEZZA | 1999-2005 | TEX/- | TOYO-30P | TPX1/TPX6/TPX5 | TPX1/TPX6/TPX5 | TP07 | 19 |
| | | 1999-2005 | TEX/- | TOYO-36P | TPX1/TPX6/TPX5 | TPX1/TPX6/TPX5 | TP07 | 19 |
| | CELSIOR | 1997-2000 | TEX/- | TOYO-18P | TPX1/TPX6/TPX5 | TPX1/TPX6/TPX5 | TP07 | 18 |
| | | 1997-2000 | TEX/- | TOYO-30P | TPX1/TPX6/TPX5 | TPX1/TPX6/TPX5 | TP07 | 19 |
| | GS300 | 1998-2005 | TEX/- | TOYO-30P | TPX1/TPX6/TPX5 | TPX1/TPX6/TPX5 | TP07 | 19 |
| | | 1998-2005 | TEX/- | TOYO-36P | TPX1/TPX6/TPX5 | TPX1/TPX6/TPX5 | TP07 | 19 |
| | GS400 | 1998-2005 | TEX/- | TOYO-30P | TPX1/TPX6/TPX5 | TPX1/TPX6/TPX5 | TP07 | 19 |
| | | 1998-2005 | TEX/- | TOYO-36P | TPX1/TPX6/TPX5 | TPX1/TPX6/TPX5 | TP07 | 19 |
| | LANDCRUISER | 1999- | TEX/- | TOYO-18P | TPX1/TPX6/TPX5 | TPX1/TPX6/TPX5 | TP07 | 18 |
| LEXUS[®] (TOYOTA[®]) (USA) | ES330 | 2001-2006 | TEX/CR | TOYO-36P | TPX2/TPX5/TPX6 | TPX2/TPX5/TPX6 | TP29 | 19 |
| | ES350 | 2007-2008 | TEX/CR | DEALER KEY | | | - | |
| | | 2009-2018 | TEX/CR | DEALER KEY | | | - | |
| | GS300/GS400 | 1998-2005 | TEX/- | TOYO-30P | TPX1/TPX6/TPX5 | TPX1/TPX6/TPX5 | TP07 | 19 |
| | | 2006-2008 | TEX/- | DEALER KEY | | | - | |
| | GS350 | 2006-2007 | TEX/- | DEALER KEY | | | - | |
| | | 2008-2018 | TEX/- | DEALER KEY | | | - | |
| | GS470 | 2003-2010 | TEX/CR | TOYO-36P | TPX2/TPX5/TPX6 | TPX2/TPX5/TPX6 | TP29 | 19 |
| | IS300 | 2001-2005 | TEX/- | TOYO-30P | TPX1/TPX6/TPX5 | TPX1/TPX6/TPX5 | TP07 | 19 |
| | LS400 | 1997- | TEX/- | TOYO-18P | TPX1/TPX6/TPX5 | TPX1/TPX6/TPX5 | TP07 | 18 |
| | | 1998-2000 | TEX/- | TOYO-30P | TPX1/TPX6/TPX5 | TPX1/TPX6/TPX5 | TP07 | 19 |
| | LS430 | 1998-2000 | TEX/- | TOYO-30P | TPX1/TPX6/TPX5 | TPX1/TPX6/TPX5 | TP07 | 19 |
| | | 2001-2006 | TEX/CR | TOYO-36P | TPX2/TPX5/TPX6 | TPX2/TPX5/TPX6 | TP29 | 19 |
| | SC300/400 | 1998-2000 | TEX/- | TOYO-30P | TPX1/TPX6/TPX5 | TPX1/TPX6/TPX5 | TP07 | 19 |
| | | 1998-2001 | TEX/- | TOYO-18P | TPX1/TPX6/TPX5 | TPX1/TPX6/TPX5 | TP07 | 18 |
| | | 2002-2006 | TEX/- | DEALER KEY | | | - | |
| | SC430 | 2002-2011 | TEX/CR | TOYO-36P | TPX2/TPX5/TPX6 | TPX2/TPX5/TPX6 | TP29 | 19 |
| LINCOLN[®] | AVIATOR | 2003-2007 | TEX/CR | FO-30DP | TPX2/TPX5/TPX6 | TPX2/TPX5/TPX6 | TP20 | 3 |
| | BLACKWOOD | 2002-2002 | TEX/- | FO-15DCP | TPX1/TPX6/TPX5 | TPX1/TPX6/TPX5 | TP02 | 3 |
| | CONTINENTAL | 1998-2002 | TEX/- | FO-15DCP | TPX1/TPX6/TPX5 | TPX1/TPX6/TPX5 | TP02 | 3 |
| | | 2002-2004 | TEX/CR | FO-15DCP | TPX2/TPX5/TPX6 | TPX2/TPX5/TPX6 | TP20 | 3 |
| | | 2017- | PHI/CR3 | FO-24P2 | | | TP39 | 13 |

AUTOMÓVIL - CAMIONETA





CAR-PICK UP TRUCK

| FOR: |  |  |  |  | TRS-5000 EVO | EVO XPERT | Programming TP |  |
|------------------|---|---|---|---|-----------------|----------------|-------------------|---|
| | | 2017- | PHI/CR3 | DEALER KEY | | | - | |
| LS | | 2000-2002 | TEX/CR | FO-15DCP | TPX2/TPX5/TPX6 | TPX2/TPX5/TPX6 | TP06 | 3 |
| | | 2003-2006 | TEX/CR | FO-30DP | TPX2/TPX5/TPX6 | TPX2/TPX5/TPX6 | TP20 | 3 |
| MARK LT | | 2006-2008 | TEX/CR | FO-30DP | TPX2/TPX5/TPX6 | TPX2/TPX5/TPX6 | TP20 | 3 |
| | | 2011-2014 | TEX/DST80 | FO-30DP | TPX7 | TPX7 | TP33 | 3 |
| MKC | | 2014- | PHI/CR3 | DEALER KEY | | | - | |
| | | 2018-2019 | PHI/CR3 | FO-24P2 | | | TP39 | 13 |
| MKS | | 2009-2009 | TEX/CR | FO-30DP | TPX2/TPX5/TPX6 | TPX2/TPX5/TPX6 | TP20 | 3 |
| | | 2009-2012 | TEX/CR | DEALER KEY | | | - | |
| | | 2013-2016 | TEX/DST80 | DEALER KEY | | | - | |
| MKT | | 2010-2011 | TEX/DST80 | FO-30DP | TPX7 | TPX7 | TP33 | 3 |
| | | 2012-2012 | TEX/DST80 | DEALER KEY | | | - | |
| | | 2013- | TEX/DST80 | DEALER KEY | | | - | |
| MKX | | 2007-2011 | TEX/CR | FO-30DP | TPX2/TPX5/TPX6 | TPX2/TPX5/TPX6 | TP20 | 3 |
| | | 2011-2013 | TEX/DST80 | FO-30DP | TPX7 | TPX7 | TP33 | 3 |
| | | 2012-2015 | TEX/DST80 | DEALER KEY | | | - | |
| | | 2016-2019 | PHI/CR3 | FO-24P2 | | | TP39 | 13 |
| | | 2016- | PHI/CR3 | DEALER KEY | | | - | |
| MKZ | | 2007-2011 | TEX/CR | FO-30DP | TPX2/TPX5/TPX6 | TPX2/TPX5/TPX6 | TP20 | 3 |
| | | 2011-2017 | TEX/DST80 | FO-30DP | TPX7 | TPX7 | TP33 | 3 |
| | | 2013-2016 | TEX/DST80 | DEALER KEY | | | - | |
| | | 2017- | PHI/CR3 | DEALER KEY | | | - | |
| NAVIGATOR | | 1998-2002 | TEX/- | FO-15DCP | TPX1/TPX6/TPX5 | TPX1/TPX6/TPX5 | TP02 | 3 |
| | | 2003-2011 | TEX/CR | FO-30DP | TPX2/TPX5/TPX6 | TPX2/TPX5/TPX6 | TP20 | 3 |
| | | 2009-2017 | TEX/DST80 | FO-30DP | TPX7 | TPX7 | TP33 | 3 |
| | | 2018-2019 | PHI/CR3 | FO-24P2 | | | TP39 | 13 |
| TOWN CAR | | 1998-2002 | TEX/- | FO-15DCP | TPX1/TPX6/TPX5 | TPX1/TPX6/TPX5 | TP02 | 3 |
| | | 2003-2012 | TEX/CR | FO-30DP | TPX2/TPX5/TPX6 | TPX2/TPX5/TPX6 | TP20 | 3 |
| ZEPHYR | | 2006-2009 | TEX/CR | FO-30DP | TPX2/TPX5/TPX6 | TPX2/TPX5/TPX6 | TP20 | 3 |
| MAHINDRA® | BOLERO | 2006- | PHI/CR2 | TAT-2DP1 | TPX4/TPX5 | TPX4/TPX5 | TP12 | 18 |
| | SCORPIO | 2006- | PHI/CR2 | TAT-2DP1 | TPX4/TPX5 | TPX4/TPX5 | TP12 | 18 |
| | | 2006- | PHI/CR2 | ORIGINAL | | | - | |
| | | 2012-2015 | MEG/CR | MHN-1P | TPX8+ | TPX8+ | TP08 | 7 |
| XUV500 | 2011- | PHI/CR3 | ORIGINAL | | | - | | |
| MASERATI® | COUPE | 2003-2007 | PHI/CR2 | SIP-4P3 | TPX4/TPX5 | TPX4/TPX5 | TP12 | 20 |
| | GRAND SPORT | 2004-2007 | MEG/CR | FI-16P | TPX8+ | TPX8+ | TP08 | 20 |
| | GRAND TURISMO | 2007-2012 | MEG/CR | FI-16P | TPX8+ | TPX8+ | TP08 | 13 |
| | QUATTROPORTE | 2004-2011 | MEG/CR | FI-16P | TPX8+ | TPX8+ | TP08 | 20 |
| MAZDA® | 121 | 1997-2001 | TEX/- | FO-6P | TPX1/TPX6/TPX5 | TPX1/TPX6/TPX5 | TP02 | 6 |
| | 323 | 1995-1997 | TEM/- | MAZ-10DP | TP05 | TP05 | TP04/TP05** | 13 |
| | | 1997-1999 | PHI/- | MAZ-11DP | TP05 | TP05 | TP01/TP05** | 14 |
| | | 1998-1999 | TEM/- | MAZ-11DP | TP05 | TP05 | TP04/TP05** | 14 |
| | | 1999-2003 | TEM/CR | MAZ-11DP | TPT1 | TPT1 | TP17 | 14 |
| | 626 | 1995-1999 | TEM/- | MAZ-9DP | TP05 | TP05 | TP04/TP05** | 13 |
| | | 1999-2002 | TEM/CR | MAZ-11DP | TPT1 | TPT1 | TP17 | 14 |
| | B-SERIES P/U | 1999-2000 | TEX/- | FO-15DP | TPX1/TPX6/TPX5 | TPX1/TPX6/TPX5 | TP02 | 13 |
| | | 2001-2006 | TEX/CR | FO-15DP | TPX2/TPX5/TPX6 | TPX2/TPX5/TPX6 | TP19 | 13 |
| | | 2007-2009 | TEX/CR | FO-30DP | TPX2/TPX5/TPX6 | TPX2/TPX5/TPX6 | TP20 | 3 |
| BT-50 | 2006-2010 | TEM/CR | DEALER KEY | TPT1 | TPT1 | TP17 | | |
| | 2011- | TEX/DST80 | FO-24P | TPX7 | TPX7 | TP33 | 6 | |

| FOR: |  |  |  |  | TRS-5000 EVO | EVO XPERT | Programming TP |  |
|---------------------------|---|---|---|---|-----------------|----------------|-------------------|---|
| | CX-3 | 2015- | PHI/CR3 | DEALER KEY | | | - | |
| | CX-4 | 2013- | PHI/CR3 | ORIGINAL | | | - | |
| | CX-5 | 2012-2014 | TEX/CR | MAZ-11DP2 | TPX2/TPX5/TPX6 | TPX2/TPX5/TPX6 | TP20 | 14 |
| | | 2012- | PHI/CR3 | DEALER KEY | | | - | |
| | CX-7 | 2006-2012 | TEX/CR | MAZ-11DP2 | TPX2/TPX5/TPX6 | TPX2/TPX5/TPX6 | TP20 | 14 |
| | | 2006-2012 | TEX/CR | DEALER KEY | | | - | |
| | CX-9 | 2007- | TEX/CR | MAZ-11DP2 | TPX2/TPX5/TPX6 | TPX2/TPX5/TPX6 | TP20 | 14 |
| | | 2007- | TEX/CR | DEALER KEY | | | TP20 | |
| | DEMIO | 1999-2002 | TEM/CR | MAZ-11DP2 | TPT1 | TPT1 | TP17 | 14 |
| | 2 | 2003-2014 | TEX/CR | MAZ-11DP2 | TPX2/TPX5/TPX6 | TPX2/TPX5/TPX6 | TP20 | 14 |
| | | 2008-2014 | TEX/CR | DEALER KEY | | | - | |
| | | 2015- | PHI/CR3 | DEALER KEY | | | - | |
| | 3 | 2004-2013 | TEX/CR | MAZ-11DP2 | TPX2/TPX5/TPX6 | TPX2/TPX5/TPX6 | TP20 | 14 |
| | | 2009-2013 | TEX/CR | DEALER KEY | | | - | |
| | | 2014- | PHI/CR3 | DEALER KEY | | | - | |
| | | 2014- | PHI/CR3 | ORIGINAL | | | - | |
| | 5 | 2005-2015 | TEX/CR | MAZ-11DP2 | TPX2/TPX5/TPX6 | TPX2/TPX5/TPX6 | TP20 | 14 |
| | 6 | 2003-2012 | TEX/CR | MAZ-11DP2 | TPX2/TPX5/TPX6 | TPX2/TPX5/TPX6 | TP20 | 14 |
| | | 2006-2012 | TEX/CR | DEALER KEY | | | - | |
| | | 2013- | PHI/CR3 | DEALER KEY | | | - | |
| | MIATA | 2001-2005 | TEM/CR | MAZ-11DP | TPT1 | TPT1 | TP17 | 14 |
| | MPV | 2000-2007 | TEM/CR | MAZ-11DP | TPT1 | TPT1 | TP17 | 14 |
| | MX 3 | 1995-1998 | TEM/- | MAZ-10DP | TP05 | TP05 | TP04/TP05** | 13 |
| | MX 5 | 1995-1998 | TEM/- | MAZ-10DP | TP05 | TP05 | TP04/TP05** | 13 |
| | | 1998-2000 | PHI/- | MAZ-11DP | TP05 | TP05 | TP01/TP05** | 14 |
| | | 2001-2005 | TEM/CR | MAZ-11DP | TPT1 | TPT1 | TP17 | 14 |
| | | 2005-2015 | TEX/CR | MAZ-11DP2 | TPX2/TPX5/TPX6 | TPX2/TPX5/TPX6 | TP20 | 14 |
| | | 2005-2015 | TEX/CR | DEALER KEY | | | - | |
| | | 2015- | PHI/CR3 | DEALER KEY | | | - | |
| | MX 6 | 1995-1997 | TEM/- | MAZ-9DP | TP05 | TP05 | TP04/TP05** | 13 |
| | PREMACY | 2000-2004 | TEM/CR | ORIGINAL | | | - | |
| | RX 8 | 2004-2012 | TEX/CR | MAZ-11DP2 | TPX2/TPX5/TPX6 | TPX2/TPX5/TPX6 | TP20 | 14 |
| | | 2010-2012 | TEX/CR | DEALER KEY | | | - | |
| | TRIBUTE | 2001-2004 | TEX/CR | FO-15DP | TPX2/TPX5/TPX6 | TPX2/TPX5/TPX6 | TP19 | 8 |
| | | 2005-2011 | TEX/CR | FO-30DP | TPX2/TPX5/TPX6 | TPX2/TPX5/TPX6 | TP20 | 3 |
| | XEDOS 6 | 1995-1999 | TEM/- | MAZ-9DP | TP05 | TP05 | TP04/TP05** | 13 |
| | XEDOS 9 | 1995-2002 | TEM/- | MAZ-12P1 | TP05 | TP05 | TP04/TP05** | 14 |
| MAZDA® (AUS) | 121 | 1999-2001 | TEM/CR | DEALER KEY | TPT1 | TPT1 | TP17 | |
| | | 1999-2001 | TEM/CR | ORIGINAL | | | - | |
| MAZDA® (JAPON) | DEMIO | 2003-2014 | TEX/CR | MAZ-11DP2 | TPX2/TPX5/TPX6 | TPX2/TPX5/TPX6 | TP20 | 14 |
| MAZDA® (SUDAFRICA) | 323 | 1995-2000 | PHI/- | MAZ-11DP | TP05 | TP05 | TP01/TP05** | 14 |
| | 626 | 1995-2000 | PHI/- | MAZ-11DP | TP05 | TP05 | TP01/TP05** | 14 |
| | MX 6 | 1995-2000 | PHI/- | MAZ-11DP | TP05 | TP05 | TP01/TP05** | 14 |
| MAZDA® (USA) | 2 | 2011-2015 | TEX/CR | MAZ-11DP2 | TPX2/TPX5/TPX6 | TPX2/TPX5/TPX6 | TP20 | 14 |
| | 3 | 2004-2013 | TEX/CR | MAZ-11DP2 | TPX2/TPX5/TPX6 | TPX2/TPX5/TPX6 | TP20 | 14 |
| | 5 | 2006-2015 | TEX/CR | MAZ-11DP2 | TPX2/TPX5/TPX6 | TPX2/TPX5/TPX6 | TP20 | 14 |
| | 6 | 2003-2013 | TEX/CR | MAZ-11DP2 | TPX2/TPX5/TPX6 | TPX2/TPX5/TPX6 | TP20 | 14 |
| | 626 | 1998-1999 | PHI/- | MAZ-11DP | TP05 | TP05 | TP01/TP05** | 14 |

AUTOMÓVIL - CAMIONETA





CAR-PICK UP TRUCK





| FOR: |  |  |  |  | TRS-5000 EVO | EVO XPERT | Programming TP |  |
|------------------|---|---|---|---|-----------------|----------------|-------------------|---|
| | | 2002-2002 | TEM/CR | ORIGINAL | | | - | |
| | B-SERIES P/U | 1999-2000 | TEX/- | FO-15DCP | TPX1/TPX6/TPX5 | TPX1/TPX6/TPX5 | TP02 | 3 |
| | | 2001-2009 | TEX/CR | FO-30DP | TPX2/TPX5/TPX6 | TPX2/TPX5/TPX6 | TP20 | 3 |
| | CX-5 | 2013-2014 | TEX/CR | MAZ-11DP2 | TPX2/TPX5/TPX6 | TPX2/TPX5/TPX6 | TP20 | 14 |
| | CX-7 | 2007-2014 | TEX/CR | MAZ-11DP2 | TPX2/TPX5/TPX6 | TPX2/TPX5/TPX6 | TP20 | 14 |
| | CX-9 | 2007-2016 | TEX/CR | MAZ-11DP2 | TPX2/TPX5/TPX6 | TPX2/TPX5/TPX6 | TP20 | 14 |
| | MIATA | 2001-2005 | TEM/- | MAZ-11DP | TPX2/TPX5/TPX6 | TPX2/TPX5/TPX6 | TP20 | 14 |
| | MPV | 2000-2004 | TEM/CR | MAZ-11DP | TPT1 | TPT1 | TP17 | 14 |
| | | 2000-2004 | TEM/CR | ORIGINAL | | | - | |
| | | 2005-2007 | TEX/CR | ORIGINAL | | | - | |
| | RX 8 | 2004-2011 | TEX/CR | MAZ-11DP2 | TPX2/TPX5/TPX6 | TPX2/TPX5/TPX6 | TP20 | 14 |
| | TRIBUTE | 2001-2004 | TEX/CR | FO-15DCP | TPX2/TPX5/TPX6 | TPX2/TPX5/TPX6 | TP06 | 3 |
| | | 2005-2011 | TEX/CR | FO-30DP | TPX2/TPX5/TPX6 | TPX2/TPX5/TPX6 | TP20 | 3 |
| MERCEDES® | CLASE A | 1997-2004 | PHI/- | ORIGINAL | | | - | |
| | | 2004-2012 | -/- | DEALER KEY | | | - | |
| | | 2012-2018 | -/- | DEALER KEY | | | - | |
| | CLASE B/C/E/S/SL | 1995- | PHI/- | ORIGINAL | | | - | |
| | CLASE C | 1996-2006 | -/- | ME-7P1 | | | - | 8 |
| | CLASE M | 1996-2006 | -/- | ME-7P1 | | | - | 8 |
| | CLK | 1998-2008 | PHI/- | ORIGINAL | | | - | |
| | SPRINTER | 1997- | TEM/- | ME-HMP1 | TP05 | TP05 | TP05 | 21 |
| | | 2007- | -/- | ME-16P | | | - | 8 |
| | VITO | 1998- | MEG/- | ME-HMP1 | TP05 | TP05 | TP03/TP05** | 21 |
| | | 1998- | TEM/- | ME-HMP1 | TP05 | TP05 | TP05 | 21 |
| | VITO (MERCOSUR) | - | MEG/- | ME-9P1 | TP05 | TP05 | TP03/TP05** | 8 |
| MERCURY® | COUGAR | 1999-2002 | TEX/- | FO-16P | TPX1/TPX6/TPX5 | TPX1/TPX6/TPX5 | TP02 | 3 |
| | GRAND MARQUIS | 1998-2002 | TEX/- | FO-15DCP | TPX1/TPX6/TPX5 | TPX1/TPX6/TPX5 | TP02 | 3 |
| | | 2003-2011 | TEX/CR | FO-30DP | TPX2/TPX5/TPX6 | TPX2/TPX5/TPX6 | TP20 | 3 |
| | MARAUDER | 2003-2005 | TEX/CR | FO-30DP | TPX2/TPX5/TPX6 | TPX2/TPX5/TPX6 | TP20 | 3 |
| | MARINER | 2005-2007 | TEX/CR | FO-30DP | TPX2/TPX5/TPX6 | TPX2/TPX5/TPX6 | TP20 | 3 |
| | | 2007-2011 | TEX/CR | FO-30DP | TPX2/TPX5/TPX6 | TPX2/TPX5/TPX6 | TP20 | 3 |
| | MILAN | 2006-2011 | TEX/CR | FO-30DP | TPX2/TPX5/TPX6 | TPX2/TPX5/TPX6 | TP20 | 3 |
| | | 2006-2011 | TEX/DST80 | FO-30DP | TPX7 | TPX7 | TP33 | 3 |
| | MONTEGO | 2005-2008 | TEX/CR | FO-30DP | TPX2/TPX5/TPX6 | TPX2/TPX5/TPX6 | TP20 | 3 |
| | MONTEREY | 2004-2007 | TEX/CR | FO-30DP | TPX2/TPX5/TPX6 | TPX2/TPX5/TPX6 | TP20 | 3 |
| | MOUNTAINEER | 1998-2001 | TEX/- | FO-15DCP | TPX1/TPX6/TPX5 | TPX1/TPX6/TPX5 | TP02 | 3 |
| | | 2002-2011 | TEX/CR | FO-30DP | TPX2/TPX5/TPX6 | TPX2/TPX5/TPX6 | TP20 | 3 |
| | MYSTIQUE V6LS | 1997-2000 | TEX/- | FO-16P | TPX1/TPX6/TPX5 | TPX1/TPX6/TPX5 | TP02 | 3 |
| | SABLE GS&LS | 1996-1999 | TEX/- | FO-15DCP | TPX1/TPX6/TPX5 | TPX1/TPX6/TPX5 | TP02 | 3 |
| | | 2000-2007 | TEX/CR | FO-30DP | TPX2/TPX5/TPX6 | TPX2/TPX5/TPX6 | TP20 | 3 |
| MINI® | CABRIO | 2004-2008 | PHI/EVO. | ORIGINAL | | | - | |
| | | 2009- | PHI/CR2 | DEALER KEY | | | - | |
| | CLUBMAN | 2007-2014 | PHI/CR2 | DEALER KEY | | | - | |
| | CONVERTIBLE | 2004-2008 | PHI/EVO. | ORIGINAL | | | - | |
| | | 2009- | PHI/CR2 | DEALER KEY | | | - | |
| | COOPER | 2001-2006 | PHI/EVO. | ORIGINAL | | | - | |
| | | 2007-2010 | PHI/CR2 | DEALER KEY | | | - | |
| | COOPER S | 2001-2006 | PHI/EVO. | ORIGINAL | | | - | |
| | COUNTRYMAN | 2010- | PHI/CR2 | DEALER KEY | | | - | |
| | COUPE | 2012- | PHI/CR2 | DEALER KEY | | | - | |

| FOR: |  |  |  |  | TRS-5000 EVO | EVO XPERT | Programming TP |  |
|--------------------|---|---|---|---|-----------------|----------------|-------------------|---|
| MITSUBISHI® | HATCHBACK | 2005-2013 | PHI/CR2 | DEALER KEY | | | - | |
| | ONE | 2001-2006 | PHI/EVO. | ORIGINAL | | | - | |
| | PACEMAN | 2013- | PHI/CR2 | DEALER KEY | | | - | |
| | ROADSTER | 2013- | PHI/CR2 | DEALER KEY | | | - | |
| | 3000 | 1996-2001 | TEX/- | ORIGINAL | TPX1/TPX6/TPX5 | TPX1/TPX6/TPX5 | TP02 | |
| | 380 | 2006- | PHI/CR2 | MIT-8DP2 | TPX4/TPX5 | TPX4/TPX5 | TP12MT | 14 |
| | ASX | 2010- | PHI/CR2 | MIT-8DP2 | TPX4/TPX5 | TPX4/TPX5 | TP12MT | 14 |
| | | 2010- | PHI/CR2 | DEALER KEY | | | - | |
| | | 2014- | PHI/CR3 | DEALER KEY | | | - | |
| | CARISMA | 1996-2000 | PHI/- | HU-DHP3 | TP01/TP05 | TP01/TP05 | TP01/TP05** | 7 |
| | | 2000-2004 | PHI/CR | HU-DHP3 | | | - | 7 |
| | CHALLENGER | 1999-2002 | TEX/CR | MIT-12P2 | TPX2/TPX5/TPX6 | TPX2/TPX5/TPX6 | TP19 | 14 |
| | | 2002-2003 | TEX/CR | MIT-12P | TPX2/TPX5/TPX6 | TPX2/TPX5/TPX6 | TP28 | |
| | COLT | 1996-2000 | TEX/- | MIT-8DP1 | TPX1/TPX6/TPX5 | TPX1/TPX6/TPX5 | TP07 | 14 |
| | | 1996-2000 | TEX/- | MIT-8DP2 | TPX1/TPX6/TPX5 | TPX1/TPX6/TPX5 | TP07 | 14 |
| | | 2000-2004 | TEX/CR | MIT-8DP1 | TPX2/TPX5/TPX6 | TPX2/TPX5/TPX6 | TP19 | 14 |
| | | 2000-2004 | TEX/CR | ORIGINAL | | | - | |
| | | 2004-2012 | PHI/CR2 | HU-DHP3 | TPX4/TPX5 | TPX4/TPX5 | TP12MT | 7 |
| | DIAMANTE | 2005-2010 | PHI/CR2 | MIT-8DP1 | TPX4/TPX5 | TPX4/TPX5 | TP12MT | 14 |
| | | 2000-2002 | TEX/CR | MIT-12P2 | TPX2/TPX5/TPX6 | TPX2/TPX5/TPX6 | TP19 | 14 |
| | ECLIPSE | 2001-2006 | TEX/CR | MIT-12P | TPX2/TPX5/TPX6 | TPX2/TPX5/TPX6 | TP26 | 14 |
| 1996-2000 | | TEX/- | MIT-12P | TPX1/TPX6/TPX5 | TPX1/TPX6/TPX5 | TP07 | 14 | |
| ENDEAVOR | 2001-2006 | TEX/CR | MIT-18P | TPX2 | TPX2 | TP26 | 14 | |
| | 2004-2006 | TEX/CR | MIT-18P | TPX4/TPX5 | TPX4/TPX5 | TP12MT | 14 | |
| | 2007-2011 | PHI/CR2 | MIT-8DP1 | TPX4/TPX5 | TPX4/TPX5 | TP12MT | 14 | |
| EXPRESS | 1996-2002 | TEX/- | MIT-12P | TPX1/TPX6/TPX5 | TPX1/TPX6/TPX5 | TP07 | 14 | |
| FOCUS | 1998-2002 | TEX/- | MIT-12P | TPX1/TPX6/TPX5 | TPX1/TPX6/TPX5 | TP07 | 14 | |
| FUSO | 2017- | MEG/CR | DEALER KEY | TPX8+ | TPX8+ | TP08 | | |
| GALANT | 1996-2000 | TEX/- | MIT-12P | TPX1/TPX6/TPX5 | TPX1/TPX6/TPX5 | TP07 | 14 | |
| | 2002-2005 | TEX/CR | MIT-12P | TPX2/TPX5/TPX6 | TPX2/TPX5/TPX6 | TP26 | 14 | |
| | 2006-2012 | PHI/CR2 | MIT-8DP2 | TPX4/TPX5 | TPX4/TPX5 | TP12MT | 14 | |
| GRANDIS | 2003-2011 | PHI/CR2 | MIT-8DP2 | TPX4/TPX5 | TPX4/TPX5 | TP12MT | 14 | |
| I-MiEV | 2010- | PHI/CR2 | MIT-8DP2 | TPX4/TPX5 | TPX4/TPX5 | TP12MT | 14 | |
| L200 | 1999-2002 | TEX/CR | MIT-12P2 | TPX2/TPX5/TPX6 | TPX2/TPX5/TPX6 | TP19 | 14 | |
| | 2002-2006 | TEX/CR | MIT-12P | TPX2/TPX5/TPX6 | TPX2/TPX5/TPX6 | TP26 | 14 | |
| | 2006-2015 | PHI/CR2 | MIT-12P | TPX4/TPX5 | TPX4/TPX5 | TP12MT | 14 | |
| | 2006-2015 | PHI/CR2 | MIT-12P2 | TPX4/TPX5 | TPX4/TPX5 | TP12MT | 14 | |
| | 2015- | PHI/CR3 | ORIGINAL | | | - | | |
| LANCER | 2015- | PHI/CR3 | DEALER KEY | | | - | | |
| | 1996-2003 | TEX/- | MIT-8DP1 | TPX1/TPX6/TPX5 | TPX1/TPX6/TPX5 | TP07 | 14 | |
| | 1996-2003 | TEX/- | MIT-8DP2 | TPX1/TPX6/TPX5 | TPX1/TPX6/TPX5 | TP07 | 14 | |
| | 2003-2006 | TEX/CR | MIT-8DP2 | TPX2/TPX5/TPX6 | TPX2/TPX5/TPX6 | TP26 | 14 | |
| | 2007- | PHI/CR2 | MIT-8DP2 | TPX4/TPX5 | TPX4/TPX5 | TP12MT | 14 | |
| LANCER EVO | 2008- | PHI/CR2 | DEALER KEY | | | - | | |
| | 2003-2006 | TEX/CR | MIT-8DP1 | TPX2/TPX5/TPX6 | TPX2/TPX5/TPX6 | TP26 | 14 | |
| | 2003-2006 | TEX/CR | MIT-8DP2 | TPX2/TPX5/TPX6 | TPX2/TPX5/TPX6 | TP26 | 14 | |
| | 2007-2009 | PHI/CR2 | ORIGINAL | | | - | | |
| | 2007-2009 | PHI/CR2 | DEALER KEY | | | - | | |

AUTOMÓVIL - CAMIONETA

CAR-PICK UP TRUCK

| FOR: |  |  |  |  | TRS-5000 EVO | EVO XPERT | Programming TP |  |
|-----------------|---|---|---|---|-----------------|----------------|-------------------|---|
| MAGNA | 1996-1999 | PHI/- | MAZ-12P1 | | TP01/TP05 | TP01/TP05 | TP01/TP05** | 14 |
| | 1999-2005 | PHI/CR2 | KI-7P | | TPX4/TPX5 | TPX4/TPX5 | TP12MT | 13 |
| MIRAGE | 1996-2002 | TEX/- | MIT-8DP1 | | TPX1/TPX6/TPX5 | TPX1/TPX6/TPX5 | TP07 | 14 |
| | 1996-2002 | TEX/- | MIT-8DP2 | | TPX1/TPX5 | TPX1/TPX5 | TP07 | 14 |
| | 2012- | PHI/CR2 | MIT-12P2 | | TPX4/TPX5 | TPX4/TPX5 | TP12MT | 14 |
| | 2012- | PHI/CR2 | DEALER KEY | | | | - | |
| | 2014- | PHI/CR3 | DEALER KEY | | | | - | |
| MONTERO | 1996-2000 | TEX/- | MIT-12P | | TPX1/TPX6/TPX5 | TPX1/TPX6/TPX5 | TP07 | 14 |
| | 2001-2006 | TEX/CR | MIT-12P2 | | TPX2/TPX5/TPX6 | TPX2/TPX5/TPX6 | TP19 | 14 |
| | 2001-2006 | TEX/CR | MIT-12P | | TPX2/TPX5/TPX6 | TPX2/TPX5/TPX6 | TP26 | 14 |
| | 2002-2003 | TEX/CR | MIT-12P | | TPX2/TPX5/TPX6 | TPX2/TPX5/TPX6 | TP28 | 14 |
| | 2006-2014 | PHI/CR2 | MIT-12P | | TPX4/TPX5 | TPX4/TPX5 | TP12MT | 14 |
| | 2006-2014 | PHI/CR2 | MIT-12P2 | | TPX4/TPX5 | TPX4/TPX5 | TP12MT | 14 |
| MONTERO IO | 1999-2002 | TEX/CR | MIT-12P2 | | TPX2/TPX5/TPX6 | TPX2/TPX5/TPX6 | TP19 | 14 |
| | 2000-2006 | TEX/CR | MIT-12P | | TPX2/TPX5/TPX6 | TPX2/TPX5/TPX6 | TP28 | 14 |
| MONTERO MINI | 1999-2003 | TEX/CR | MIT-12P2 | | TPX2/TPX5/TPX6 | TPX2/TPX5/TPX6 | TP19 | 14 |
| | 2003- | TEX/CR | MIT-12P | | TPX2/TPX5/TPX6 | TPX2/TPX5/TPX6 | TP26 | |
| MONTERO PININ | 1999-2003 | TEX/CR | MIT-12P2 | | TPX2/TPX5/TPX6 | TPX2/TPX5/TPX6 | TP19 | 14 |
| | 2003- | TEX/CR | MIT-12P | | TPX2/TPX5/TPX6 | TPX2/TPX5/TPX6 | TP26 | 14 |
| MONTERO SPORT | 2000-2001 | TEX/CR | MIT-12P2 | | TPX2/TPX5/TPX6 | TPX2/TPX5/TPX6 | TP19 | 14 |
| | 2001-2004 | TEX/CR | MIT-12P | | TPX2/TPX5/TPX6 | TPX2/TPX5/TPX6 | TP28 | 14 |
| | 2001-2006 | TEX/CR | MIT-12P | | TPX2/TPX5/TPX6 | TPX2/TPX5/TPX6 | TP26 | 14 |
| | 2007-2014 | PHI/CR2 | MIT-12P | | TPX4/TPX5 | TPX4/TPX5 | TP12MT | 14 |
| NATIVA | 2001-2002 | TEX/CR | MIT-12P2 | | TPX2/TPX5/TPX6 | TPX2/TPX5/TPX6 | TP19 | 14 |
| | 2008-2014 | PHI/CR2 | MIT-12P | | TPX4/TPX5 | TPX4/TPX5 | TP12MT | 14 |
| NIMBUS | 1998-1999 | TEX/- | MIT-12P | | TPX1/TPX6/TPX5 | TPX1/TPX6/TPX5 | TP07 | 14 |
| | 1999-2002 | TEX/CR | ORIGINAL | | | | - | |
| OUTLANDER | 2000-2003 | TEX/CR | MIT-12P2 | | TPX2/TPX5/TPX6 | TPX2/TPX5/TPX6 | TP19 | 14 |
| | 2004-2008 | TEX/CR | MIT-8DP1 | | TPX2/TPX5/TPX6 | TPX2/TPX5/TPX6 | TP26 | 14 |
| | 2004-2008 | TEX/CR | MIT-8DP2 | | TPX2/TPX5/TPX6 | TPX2/TPX5/TPX6 | TP26 | 14 |
| | 2007- | PHI/CR2 | MIT-8DP2 | | TPX4/TPX5 | TPX4/TPX5 | TP12MT | 14 |
| | 2007-2016 | PHI/CR2 | DEALER KEY | | | | - | |
| 2013- | PHI/CR3 | DEALER KEY | | | | - | | |
| OUTLANDER SPORT | 2011- | PHI/CR2 | MIT-8DP1 | | TPX4/TPX5 | TPX4/TPX5 | TP12MT | 14 |
| | 2011- | PHI/CR2 | DEALER KEY | | | | - | |
| PAJERO | 1996-2000 | TEX/- | MIT-12P | | TPX1/TPX6/TPX5 | TPX1/TPX6/TPX5 | TP07 | 14 |
| | 2000-2002 | TEX/CR | MIT-12P2 | | TPX2/TPX5/TPX6 | TPX2/TPX5/TPX6 | TP19 | 14 |
| | 2002-2003 | TEX/CR | MIT-12P | | TPX2/TPX5/TPX6 | TPX2/TPX5/TPX6 | TP28 | 14 |
| | 2002-2005 | TEX/CR | MIT-12P | | TPX2/TPX5/TPX6 | TPX2/TPX5/TPX6 | TP26 | 14 |
| | 2006- | PHI/CR2 | MIT-12P | | TPX4/TPX5 | TPX4/TPX5 | TP12MT | 13 |
| | 2006- | PHI/CR2 | MIT-12P2 | | TPX4/TPX5 | TPX4/TPX5 | TP12MT | 14 |
| PAJERO IO | 1999-2002 | TEX/CR | MIT-12P2 | | TPX2/TPX5/TPX6 | TPX2/TPX5/TPX6 | TP19 | 14 |
| | 2002- | TEX/CR | MIT-12P | | TPX2/TPX5/TPX6 | TPX2/TPX5/TPX6 | TP26 | 14 |
| PAJERO MINI | 1999-2004 | TEX/CR | MIT-12P2 | | TPX2/TPX5/TPX6 | TPX2/TPX5/TPX6 | TP28 | 14 |
| | 1999-2004 | TEX/CR | MIT-12P | | TPX2/TPX5/TPX6 | TPX2/TPX5/TPX6 | TP28 | 14 |
| PAJERO PININ | 1998-2007 | TEX/CR | MIT-12P2 | | TPX2/TPX5/TPX6 | TPX2/TPX5/TPX6 | TP28 | 14 |
| | 1998-2007 | TEX/CR | MIT-12P | | TPX2/TPX5/TPX6 | TPX2/TPX5/TPX6 | TP26 | 14 |
| PAJERO SPORT | 1999-2002 | TEX/CR | MIT-12P2 | | TPX2/TPX5/TPX6 | TPX2/TPX5/TPX6 | TP19 | 14 |
| | 2002-2003 | TEX/CR | MIT-12P | | TPX2/TPX5/TPX6 | TPX2/TPX5/TPX6 | TP28 | 14 |
| | 2003-2006 | TEX/CR | MIT-12P | | TPX2/TPX5/TPX6 | TPX2/TPX5/TPX6 | TP26 | 14 |

| FOR: |  |  |  |  | TRS-5000 EVO | EVO XPERT | Programming TP |  |
|----------------------------|---|---|---|---|-----------------|----------------|-------------------|---|
| | RAIDER | 2006-2010 | PHI/CR2 | CHR-15P | TPX4/TPX5 | TPX4/TPX5 | TP12MT | 1 |
| | SHOGUN | 1996-2000 | TEX/- | MIT-12P | TPX1/TPX6/TPX5 | TPX1/TPX6/TPX5 | TP07 | 14 |
| | | 2000-2002 | TEX/CR | MIT-12P2 | TPX2/TPX5/TPX6 | TPX2/TPX5/TPX6 | TP19 | 14 |
| | | 2002-2003 | TEX/CR | MIT-12P | TPX2/TPX5/TPX6 | TPX2/TPX5/TPX6 | TP28 | 14 |
| | | 2002-2005 | TEX/CR | MIT-12P | TPX2/TPX5/TPX6 | TPX2/TPX5/TPX6 | TP26 | |
| | SHOGUN PININ | 1999-2004 | TEX/CR | MIT-8DP1 | TPX2/TPX5/TPX6 | TPX2/TPX5/TPX6 | TP26 | 14 |
| | | 1999-2004 | TEX/CR | MIT-8DP2 | TPX2/TPX5/TPX6 | TPX2/TPX5/TPX6 | TP26 | 14 |
| | SHOGUN SPORT | 1999-2002 | TEX/CR | MIT-12P2 | TPX2/TPX5/TPX6 | TPX2/TPX5/TPX6 | TP19 | 14 |
| | | 2002-2003 | TEX/CR | MIT-12P | TPX2/TPX5/TPX6 | TPX2/TPX5/TPX6 | TP28 | 14 |
| | SPACE GEAR | 1996-2002 | TEX/- | MIT-12P | TPX1/TPX6/TPX5 | TPX1/TPX6/TPX5 | TP07 | |
| | SPACE RUNNER | 1998-1999 | TEX/- | MIT-12P | TPX1/TPX6/TPX5 | TPX1/TPX6/TPX5 | TP07 | 14 |
| | | 1999-2005 | TEX/CR | MIT-12P | TPX2/TPX5/TPX6 | TPX2/TPX5/TPX6 | TP26 | 14 |
| | SPACE STAR | 1999- | TEX/CR | MIT-12P2 | TPX2/TPX5/TPX6 | TPX2/TPX5/TPX6 | TP19 | 14 |
| | | 1999-2005 | PHI/CR | HU-DHP3 | | | - | 7 |
| | SPACE WAGON | 1998-1999 | TEX/- | MIT-12P | TPX1/TPX6/TPX5 | TPX1/TPX6/TPX5 | TP07 | |
| | | 1999-2003 | TEX/CR | MIT-12P2 | TPX2/TPX5/TPX6 | TPX2/TPX5/TPX6 | TP19 | 14 |
| | TRITON | 1999-2002 | TEX/CR | MIT-12P2 | TPX2/TPX5/TPX6 | TPX2/TPX5/TPX6 | TP19 | 14 |
| | | 2002-2006 | TEX/CR | MIT-12P2 | TPX2/TPX5/TPX6 | TPX2/TPX5/TPX6 | TP26 | 14 |
| | | 2006-2015 | PHI/CR2 | MIT-12P2 | TPX4/TPX5 | TPX4/TPX5 | TP12MT | 14 |
| | VERADA | 2000-2002 | TEX/CR | MIT-12P2 | TPX2/TPX5/TPX6 | TPX2/TPX5/TPX6 | TP19 | 14 |
| | 2002-2003 | TEX/CR | MIT-12P2 | TPX2/TPX5/TPX6 | TPX2/TPX5/TPX6 | TP26 | 14 | |
| MITSUBISHI® (AUSTRALIA) | | 1996-2000 | PHI/- | MAZ-12P1 | TP01/TP05 | TP01/TP05 | TP01/TP05** | 14 |
| | | 2000-2002 | PHI/CR2 | KI-7P | TPX4/TPX5 | TPX4/TPX5 | TP12MT | 13 |
| MITSUBISHI® (USA) | DIAMANTE | 2000-2000 | TEX/CR | MIT-12P2 | TPX2/TPX5/TPX6 | TPX2/TPX5/TPX6 | TP19 | 14 |
| | | 2001-2006 | TEX/CR | MIT-12P2 | TPX2/TPX5/TPX6 | TPX2/TPX5/TPX6 | TP26 | 14 |
| ECLIPSE | 2000-2000 | TEX/CR | MIT-18P | TPX2/TPX5/TPX6 | TPX2/TPX5/TPX6 | TP19 | 14 | |
| | 2001-2005 | TEX/CR | MIT-18P | TPX2/TPX5/TPX6 | TPX2/TPX5/TPX6 | TP26 | 14 | |
| | 2006-2007 | PHI/CR2 | MIT-18P | TPX4/TPX5 | TPX4/TPX5 | TP12MT | 14 | |
| | 2008-2012 | PHI/CR2 | MIT-8DP2 | TPX4/TPX5 | TPX4/TPX5 | TP12MT | 14 | |
| ENDEAVOR | 2001-2006 | TEX/CR | MIT-18P | TPX2/TPX5/TPX6 | TPX2/TPX5/TPX6 | TP26 | 14 | |
| | 2007-2011 | PHI/CR2 | MIT-8DP2 | TPX4/TPX5 | TPX4/TPX5 | TP12MT | 14 | |
| GALANT | 2000-2001 | TEX/CR | MIT-18P | TPX2/TPX5/TPX6 | TPX2/TPX5/TPX6 | TP19 | 14 | |
| | 2002-2003 | TEX/CR | MIT-18P | TPX2/TPX5/TPX6 | TPX2/TPX5/TPX6 | TP26 | 14 | |
| | 2004-2007 | PHI/CR2 | MIT-18P | TPX4/TPX5 | TPX4/TPX5 | TP12MT | 14 | |
| | 2008-2012 | PHI/CR2 | MIT-8DP2 | TPX4/TPX5 | TPX4/TPX5 | TP12MT | 14 | |
| LANCER | 2007-2018 | PHI/CR2 | MIT-8DP2 | TPX4/TPX5 | TPX4/TPX5 | TP12MT | 14 | |
| | 2008-2016 | PHI/CR2 | DEALER KEY | | | - | | |
| LANCER EVO | 2003-2006 | TEX/CR | MIT-8DP2 | TPX2/TPX5 | TPX2/TPX5 | TP26 | 14 | |
| | 2007-2009 | TEX/CR | DEALER KEY | | | - | | |
| MONTERO | 2001-2006 | TEX/CR | MIT-12P2 | TPX2/TPX5/TPX6 | TPX2/TPX5/TPX6 | TP26 | 14 | |
| MONTERO SPORT | 2000-2000 | TEX/CR | MIT-12P2 | TPX2/TPX5/TPX6 | TPX2/TPX5/TPX6 | TP19 | 14 | |
| | 2001-2006 | TEX/CR | MIT-12P | TPX2/TPX5/TPX6 | TPX2/TPX5/TPX6 | TP26 | 15 | |
| | 2007-2008 | TEX/CR | DEALER KEY | | | - | | |
| OUTLANDER | 2007-2018 | PHI/CR2 | MIT-8DP2 | TPX4/TPX5 | TPX4/TPX5 | TP12MT | 14 | |
| OUTLANDER SPORT | 2011-2018 | PHI/CR2 | MIT-8DP2 | TPX4/TPX5 | TPX4/TPX5 | TP12MT | 14 | |
| RAIDER | 2006-2010 | PHI/CR2 | CHR-15P | TPX4/TPX5 | TPX4/TPX5 | TP12CH | 1 | |

AUTOMÓVIL - CAMIONETA





CAR-PICK UP TRUCK





| FOR: |  |  |  |  | TRS-5000 EVO | EVO XPERT | Programming TP |  |
|----------------|---|---|---|---|-----------------|----------------|-------------------|---|
| NISSAN® | 350 Z | 2003-2009 | TEX/CR | DAT-15P4 | TPX2/TPX5/TPX6 | TPX2/TPX5/TPX6 | TP19 | 16 |
| | 370 Z | 2009-2013 | PHI/CR2 | DEALER KEY | | | - | |
| | ALMERA | 1999-2000 | PHI/CR | DAT-15P2 | TPH1 | TPH1 | TP13 | 15 |
| | | 2000-2003 | TEX/CR | DAT-15P2 | TPX2/TPX5/TPX6 | TPX2/TPX5/TPX6 | TP19 | 15 |
| | | 2003-2006 | PHI/CR2 | DAT-15P2 | TPX4/TPX5 | TPX4/TPX5 | TP12NS | 15 |
| | | 2003-2006 | TEX/CR | DAT-15P2 | TPX2/TPX5/TPX6 | TPX2/TPX5/TPX6 | - | 15 |
| | ALMERA TINO | 2000-2003 | TEX/CR | DAT-15P2 | TPX2/TPX5/TPX6 | TPX2/TPX5/TPX6 | TP19 | 15 |
| | | 2004-2006 | PHI/CR2 | DAT-15P2 | TPX4/TPX5 | TPX4/TPX5 | TP12NS | 15 |
| | ALTIMA | 2001-2004 | TEX/CR | DAT-15P2 | TPX2/TPX5/TPX6 | TPX2/TPX5/TPX6 | TP19 | 15 |
| | | 2005- | PHI/CR2 | DAT-15P2 | TPX4/TPX5 | TPX4/TPX5 | TP12NS | 15 |
| | ALTIMA 2dr | 2007-2013 | PHI/CR2 | DEALER KEY | TPX4/TPX5 | TPX4/TPX5 | - | |
| | ALTIMA 4dr | 2007-2012 | PHI/CR2 | DEALER KEY | TPX4/TPX5 | TPX4/TPX5 | - | |
| | ALTIMA HYBRID | 2007-2011 | PHI/CR2 | DEALER KEY | TPX4/TPX5 | TPX4/TPX5 | - | |
| | ARMADA | 2004- | TEX/CR | DAT-15P2 | TPX2/TPX5/TPX6 | TPX2/TPX5/TPX6 | TP19 | 15 |
| | CUBE | 2002-2013 | PHI/CR2 | DAT-15P2 | TPX4/TPX5 | TPX4/TPX5 | TP12NS | 15 |
| | | 2009-2013 | PHI/CR2 | DEALER KEY | | | - | |
| | FRONTIER P/UP | 2002- | TEX/CR | DAT-15P2 | TPX2/TPX5/TPX6 | TPX2/TPX5/TPX6 | TP19 | 15 |
| | | 2002-2013 | TEX/CR | DAT-15P2 | TPX2/TPX5/TPX6 | TPX2/TPX5/TPX6 | TP19 | 15 |
| | | 2014- | PHI/CR | DAT-15P2 | TPX4/TPX5 | TPX4/TPX5 | TP12NS | 15 |
| | GT-R | 2009-2013 | PHI/CR2 | DEALER KEY | TPX4/TPX5 | TPX4/TPX5 | TP12NS | |
| | INTERSTAR | 1998-2001 | PHI/- | NE-38P4 | TP01/TP05 | TP01/TP05 | TP01/TP05** | 15 |
| | | 2002-2010 | PHI/CR2 | NE-38P4 | TPX4/TPX5 | TPX4/TPX5 | TP12NS | 15 |
| | JUKE | 2010- | PHI/CR2 | DAT-15P2 | TPX4/TPX5 | TPX4/TPX5 | TP12NS | 15 |
| | | 2010- | PHI/CR2 | DEALER KEY | | | - | |
| | KING CAB | 2008-2011 | PHI/CR | DAT-15P2 | TPX4/TPX5 | TPX4/TPX5 | TP12NS | 15 |
| | KUBISTAR | 2003- | PHI/CR2 | VA-34P4 | TPX4/TPX5 | TPX4/TPX5 | TP12NS | 20 |
| | LIVINA | 2009-2013 | PHI/CR | DAT-15P2 | TPX4/TPX5 | TPX4/TPX5 | TP12NS | 15 |
| | MAXIMA | 1995-1999 | PHI/- | DAT-6P2 | TP01/TP05 | TP01/TP05 | TP01/TP05** | 15 |
| | | 2000-2003 | PHI/CR | DAT-6P2 | TPH1 | TPH1 | TP13 | 15 |
| | MICRA | 1996-1998 | PHI/- | DAT-6P2 | TP01/TP05 | TP01/TP05 | TP01/TP05** | 15 |
| | | 1998-2000 | PHI/CR | DAT-6P2 | TPH1 | TPH1 | TP13 | 15 |
| | | 2000-2003 | TEX/CR | DAT-6P2 | TPX2/TPX5/TPX6 | TPX2/TPX5/TPX6 | TP19 | 15 |
| | | 2003-2010 | TEX/CR | DAT-15P2 | TPX2/TPX5/TPX6 | TPX2/TPX5/TPX6 | - | 15 |
| | | 2003-2010 | TEX/CR | DEALER KEY | | | - | |
| | | 2003-2016 | PHI/CR | DEALER KEY | | | - | |
| | | 2003-2016 | PHI/CR2 | DAT-15P2 | TPX4/TPX5 | TPX4/TPX5 | TP12NS | 15 |
| | | 2016- | PHI/CR3 | ORIGINAL | | | - | |
| | 2016- | PHI/CR3 | DEALER KEY | | | - | | |
| | MICRA VAN | 1998-2000 | PHI/CR | DAT-6P2 | TPH1 | TPH1 | TP13 | 15 |
| | | 2000-2003 | TEX/CR | DAT-6P2 | TPX2/TPX5/TPX6 | TPX2/TPX5/TPX6 | TP19 | 15 |
| | MURANO | 2003-2008 | TEX/CR2 | DAT-15P2 | TPX2/TPX5/TPX6 | TPX2/TPX5/TPX6 | - | 15 |
| | | 2003-2008 | PHI/CR | DEALER KEY | | | - | |
| | MURANO CROSS C. | 2009-2013 | PHI/CR2 | DEALER KEY | TPX4/TPX5 | TPX4/TPX5 | TP12NS | |
| | NAVARA | 2000-2003 | PHI/CR | DAT-15P2 | TPH1 | TPH1 | TP13 | 15 |
| | | 2003-2005 | TEX/CR | DAT-15P2 | TPX2/TPX5/TPX6 | TPX2/TPX5/TPX6 | TP19 | 15 |
| | | 2003-2005 | TEX/CR | DAT-15P2 | TPX2/TPX5/TPX6 | TPX2/TPX5/TPX6 | - | 15 |
| | | 2005-2015 | PHI/CR2 | DAT-15P2 | TPX4/TPX5 | TPX4/TPX5 | TP12NS | 15 |
| 2008- | | PHI/CR2 | DEALER KEY | | | - | | |
| NOTE | 2004-2012 | TEX/CR | DAT-15P2 | TPX2/TPX5/TPX6 | TPX2/TPX5/TPX6 | - | 15 | |
| | 2004-2012 | PHI/CR2 | DAT-15P2 | TPX4/TPX5 | TPX4/TPX5 | TP12NS | 15 | |

| FOR: |  |  |  |  | TRS-5000 EVO | EVO XPERT | Programming TP |  |
|---------------|---|---|---|---|-----------------|----------------|-------------------|---|
| | | 2004-2012 | TEX/CR2 | DEALER KEY | | | - | |
| | | 2013- | PHI/CR3 | ORIGINAL | | | - | |
| | | 2013- | PHI/CR3 | DEALER KEY | | | - | |
| NP 300 | | 2008-2015 | PHI/CR2 | DAT-15P2 | TPX4/TPX5 | TPX4/TPX5 | TP12NS | 15 |
| NV 200 | | 2009-2013 | PHI/CR2 | DAT-15P2 | TPX4/TPX5 | TPX4/TPX5 | TP12NS | 15 |
| NV300 | | 2016- | PHI/CR3 | ORIGINAL | | | - | |
| NV 400 | | 2011- | PHI/CR2 | CIT-1P | TPX4/TPX5 | TPX4/TPX5 | TP12NS | 21 |
| NX ALMERA | | 1995-1998 | PHI/- | DAT-6P2 | TP01/TP05 | TP01/TP05 | TP01/TP05** | 15 |
| | | 1998-1999 | PHI/CR | DAT-6P2 | TPH1 | TPH1 | TP13 | 15 |
| | | 2000- | TEX/- | DAT-6P2 | TPX1/TPX6/TPX5 | TPX1/TPX6/TPX5 | TP07 | 15 |
| PATHFINDER | | 1999-2004 | TEX/CR | DAT-15P2 | TPX2/TPX5/TPX6 | TPX2/TPX5/TPX6 | TP19 | 15 |
| | | 2005-2014 | PHI/CR2 | DAT-15P2 | TPX4/TPX5 | TPX4/TPX5 | TP12NS | 15 |
| | | 2005-2014 | PHI/CR2 | DEALER KEY | | | - | |
| PATROL | | 1998-2003 | PHI/CR | DAT-15P2 | TPH1 | TPH1 | TP13 | 15 |
| PATROL GR | | 2002-2010 | TEX/CR | DAT-15P2 | TPX2/TPX5/TPX6 | TPX2/TPX5/TPX6 | - | 15 |
| | | 2006-2010 | PHI/CR2 | DAT-15P2 | TPX4/TPX5 | TPX4/TPX5 | TP12NS | 15 |
| | | 2006-2010 | PHI/CR2 | ORIGINAL | | | - | |
| PIXO | | 2009-2013 | PHI/CR2 | SUZU-14P2 | TPX4/TPX5 | TPX4/TPX5 | TP12NS | 17 |
| | | 2009-2013 | PHI/CR2 | SUZU-20DP2 | TPX4/TPX5 | TPX4/TPX5 | TP12NS | 17 |
| PLATINA | | 2001- | PHI/CR | - | | | - | |
| PRIMASTAR | | 2003-2016 | PHI/CR2 | NE-38P4 | TPX4/TPX5 | TPX4/TPX5 | TP12NS | 15 |
| PRIMERA | | 1995-1996 | PHI/- | DAT-6P2 | TP01/TP05 | TP01/TP05 | TP01/TP05** | 15 |
| | | 1997-1998 | PHI/- | DAT-15P2 | TP01/TP05 | TP01/TP05 | TP01/TP05** | 15 |
| | | 1998-2000 | TEX/CR | DAT-15P2 | TPX2/TPX5/TPX6 | TPX2/TPX5/TPX6 | TP19 | 15 |
| | | 2000-2002 | PHI/CR | DAT-15P2 | TPH1 | TPH1 | TP13 | 15 |
| | | 2002-2008 | PHI/CR2 | DAT-15P2 | TPX4/TPX5 | TPX4/TPX5 | TP12NS | 15 |
| PULSAR | | 1995-1996 | PHI/- | DAT-6P2 | TP01/TP05 | TP01/TP05 | TP01/TP05** | 15 |
| | | 1997-1998 | PHI/- | DAT-15P2 | TP01/TP05 | TP01/TP05 | TP01/TP05** | 15 |
| | | 1998-2000 | TEX/CR | DAT-15P2 | TPX2/TPX5/TPX6 | TPX2/TPX5/TPX6 | TP19 | 15 |
| | | 2000-2004 | PHI/CR | DAT-15P2 | TPH1 | TPH1 | TP13 | 15 |
| | | 2014- | PHI/CR3 | ORIGINAL | | | - | |
| | | 2014- | PHI/CR3 | DEALER KEY | | | - | |
| QASHQAI | | 2007-2013 | PHI/CR2 | DAT-15P2 | TPX4/TPX5 | TPX4/TPX5 | TP12NS | 15 |
| | | 2007-2013 | PHI/CR2 | DAT-15P2 | TPX4/TPX5 | TPX4/TPX5 | - | 15 |
| | | 2007-2013 | TEX/CR | DEALER KEY | | | - | |
| | | 2014- | PHI/CR3 | ORIGINAL | | | - | |
| | | 2014- | PHI/CR3 | DEALER KEY | | | - | |
| QUEST | | 2004- | PHI/CR2 | DAT-15P2 | TPX4/TPX5 | TPX4/TPX5 | TP12NS | 15 |
| SENTRA | | 2000- | TEX/CR | DAT-15P2 | TPX2/TPX5/TPX6 | TPX2/TPX5/TPX6 | TP19 | 15 |
| | | 2000-2006 | TEX/CR | DAT-15P4 | TPX2/TPX5/TPX6 | TPX2/TPX5/TPX6 | TP19 | 16 |
| SERENA | | 1996-1999 | PHI/- | DAT-6P2 | TP01/TP05 | TP01/TP05 | TP01/TP05** | 15 |
| TERRANO 3000D | | 1998- | PHI/CR | DAT-6P2 | TPH1 | TPH1 | TP13 | 15 |
| TERRANO II | | 1995-1998 | PHI/- | DAT-6P2 | TP01/TP05 | TP01/TP05 | TP01/TP05** | 15 |
| | | 1998-2001 | PHI/CR | DAT-6P2 | TPH1 | TPH1 | TP13 | 15 |
| | | 2002-2006 | TEX/CR | DAT-6P2 | TPX2/TPX5/TPX6 | TPX2/TPX5/TPX6 | TP19 | 15 |
| TIIDA | | 2005-2013 | PHI/CR2 | DAT-15P2 | TPX4/TPX5 | TPX4/TPX5 | TP12NS | 5 |
| VANETTE CARGO | | 1996-1999 | PHI/- | DAT-6P2 | TP01/TP05 | TP01/TP05 | TP01/TP05** | 15 |
| | | 1999-2000 | PHI/CR | DAT-6P2 | TPH1 | TPH1 | TP13 | 15 |
| | | 2000- | TEX/CR | DAT-6P2 | TPX2/TPX5/TPX6 | TPX2/TPX5/TPX6 | TP19 | 15 |
| X-TERRA | | 2000-2004 | TEX/CR | DAT-15P2 | TPX2/TPX5/TPX6 | TPX2/TPX5/TPX6 | TP19 | 15 |

AUTOMÓVIL - CAMIONETA





CAR-PICK UP TRUCK





| FOR: |  |  |  |  | TRS-5000 EVO | EVO XPERT | Programming TP |  |
|--------------------|---|---|---|---|-----------------|----------------|-------------------|---|
| | | 2005- | PHI/CR2 | DAT-15P2 | TPX4/TPX5 | TPX4/TPX5 | TP12NS | 15 |
| X-TRAIL | | 2001-2003 | TEX/CR | DAT-15P2 | TPX2/TPX5/TPX6 | TPX2/TPX5/TPX6 | TP19 | 15 |
| | | 2004-2007 | -/- | DAT-15P2 | TPX2/TPX5/TPX6 | TPX2/TPX5/TPX6 | - | 15 |
| | | 2007-2013 | PHI/CR2 | DAT-15P2 | TPX4/TPX5 | TPX4/TPX5 | - | 15 |
| | | 2014- | PHI/CR3 | DAT-15P2 | | | - | 15 |
| | | 2014- | PHI/CR3 | ORIGINAL | | | - | |
| | | 2014- | PHI/CR3 | DEALER KEY | | | - | |
| | | | | | | | | |
| NISSAN® (JAPON) | CEFIRO | 2000-2003 | TEX/CR | DAT-15P4 | TPX2/TPX5/TPX6 | TPX2/TPX5/TPX6 | TP19 | 16 |
| | INFINITI | 1997-1999 | TEX/- | ORIGINAL | | | - | |
| | LAUREL | 1999-2000 | PHI/CR | DEALER KEY | | | - | |
| | | 2000-2002 | TEX/- | DEALER KEY | | | - | |
| | MICRA MARCH | 1996-1998 | PHI/- | DAT-6P2 | TP01/TP05 | TP01/TP05 | TP01/TP05** | 15 |
| | | 1998-2000 | PHI/CR | DAT-6P2 | TPH1 | TPH1 | TP13 | 15 |
| | | 2000-2003 | TEX/CR | DAT-6P2 | TPX2/TPX5/TPX6 | TPX2/TPX5/TPX6 | TP19 | 15 |
| | SUNNY | 1996-1998 | PHI/- | DAT-6P2 | TP01/TP05 | TP01/TP05 | TP01/TP05** | 15 |
| | X-TRAIL | 1998-2000 | PHI/CR | DAT-15P2 | TPH1 | TPH1 | TP13 | 15 |
| 2001- | | TEX/CR | DAT-15P2 | TPX2/TPX5/TPX6 | TPX2/TPX5/TPX6 | TP19 | 15 | |
| NISSAN® (USA) | 350 Z | 2003-2009 | PHI/CR2 | DAT-15P3 | TPX4/TPX5 | TPX4/TPX5 | TP12NS | 16 |
| | 370Z Coupe | 2009- | PHI/CR2 | DEALER KEY | | | - | |
| | ALTIMA | 2000-2004 | TEX/CR | DAT-15P4 | TPX2/TPX5/TPX6 | TPX2/TPX5/TPX6 | TP19 | 16 |
| | | 2005-2006 | PHI/CR2 | DAT-15P3 | TPX4/TPX5 | TPX4/TPX5 | TP12NS | 16 |
| | ALTIMA | 2007-2015 | PHI/CR2 | DEALER KEY | | | - | |
| | | 2016- | PHI/CR3 | DEALER KEY | | | - | |
| | ARMADA | 2004-2014 | PHI/CR2 | DAT-15P3 | TPX4/TPX5 | TPX4/TPX5 | TP12NS | 16 |
| | | 2008-2013 | PHI/CR2 | DEALER KEY | | | - | |
| | | 2014 - | PHI/CR2 | DEALER KEY | | | - | |
| | CUBE | 2009-2015 | PHI/CR2 | DAT-15P3 | TPX4/TPX5 | TPX4/TPX5 | TP12NS | 16 |
| | | 2009-2015 | PHI/CR2 | DEALER KEY | | | - | |
| | FRONTIER | 2002-2005 | TEX/CR | DAT-15P3 | TPX2/TPX5/TPX6 | TPX2/TPX5/TPX6 | TP19 | 16 |
| | | 2006-2018 | PHI/CR2 | DAT-15P3 | TPX4/TPX5 | TPX4/TPX5 | TP12NS | 16 |
| | GT-R | 2009-2016 | PHI/CR2 | DEALER KEY | | | - | |
| | JUKE | 2011-2015 | PHI/CR2 | DAT-15P3 | TPX4/TPX5 | TPX4/TPX5 | TP12NS | 16 |
| | | 2011-2016 | PHI/CR2 | DEALER KEY | | | - | |
| | LEAF | 2012-2016 | PHI/CR2 | DEALER KEY | | | - | |
| | LIVINA | 2006-2013 | PHI/CR2 | DAT-15P3 | TPX4/TPX5 | TPX4/TPX5 | TP12NS | 16 |
| | | 2006-2013 | PHI/CR2 | DEALER KEY | | | - | |
| | MAXIMA | 1999-1999 | PHI/CR | DAT-6P2 | TP05 | TP05 | TP01/TP05** | 15 |
| | | 2000-2003 | TEX/CR | DAT-15P4 | TPX2/TPX5/TPX6 | TPX2/TPX5/TPX6 | TP19 | 16 |
| | | 2004-2007 | PHI/CR2 | DAT-15P3 | TPX4/TPX5 | TPX4/TPX5 | TP12NS | 16 |
| | | 2008-2015 | PHI/CR2 | DEALER KEY | | | - | |
| | | 2016- | PHI/CR3 | DEALER KEY | | | - | |
| | MICRA | 2015-2015 | PHI/CR2 | DAT-15P3 | TPX4/TPX5 | TPX4/TPX5 | TP12NS | 16 |
| | MURANO | 2003-2008 | PHI/CR2 | DAT-15P3 | TPX4/TPX5 | TPX4/TPX5 | TP12NS | 16 |
| | | 2005-2008 | PHI/CR2 | DEALER KEY | | | - | |
| | | 2009-2014 | PHI/CR2 | DEALER KEY | | | - | |
| | | 2015 - | PHI/CR3 | DEALER KEY | | | - | |
| | NV 1500/2500/3500 | 2012- | PHI/CR2 | DAT-15P3 | TPX4/TPX5 | TPX4/TPX5 | TP12NS | 16 |
| NV 200 | 2013 - | PHI/CR2 | DAT-15P3 | TPX4/TPX5 | TPX4/TPX5 | TP12NS | 16 | |
| PATHFINDER | 1999-2004 | TEX/CR | DAT-15P3 | TPX2/TPX5/TPX6 | TPX2/TPX5/TPX6 | TP19 | 16 | |

| FOR: |  |  |  |  | TRS-5000 EVO | EVO XPERT | Programming TP |  |
|--------------------|---|---|---|---|-----------------|----------------|-------------------|---|
| QUEST | 2005-2014 | PHI/CR2 | DAT-15P3 | TPX4/TPX5 | TPX4/TPX5 | TP12NS | 16 | |
| | 2007-2012 | PHI/CR2 | DEALER KEY | - | - | - | - | |
| | 2013 - | PHI/CR2 | DEALER KEY | - | - | - | - | |
| | 2004-2010 | PHI/CR2 | DAT-15P3 | TPX4/TPX5 | TPX4/TPX5 | TP12NS | 16 | |
| | 2011- | PHI/CR2 | DEALER KEY | - | - | - | - | |
| | ROGUE | 2008-2013 | PHI/CR2 | DEALER KEY | - | - | - | - |
| | | 2014- | PHI/CR2 | DEALER KEY | - | - | - | - |
| | | 2008-2015 | PHI/CR2 | DAT-15P3 | TPX4/TPX5 | TPX4/TPX5 | TP12NS | 16 |
| | | 2016- | PHI/CR3 | DEALER KEY | - | - | - | - |
| | SENTRA | 2000-2006 | TEX/CR | DAT-15P4 | TPX2/TPX5/TPX6 | TPX2/TPX5/TPX6 | TP19 | 16 |
| | | 2007- | PHI/CR2 | DAT-15P3 | TPX4/TPX5 | TPX4/TPX5 | TP12NS | 16 |
| | | 2007-2012 | PHI/CR2 | DEALER KEY | - | - | - | - |
| | | 2013- | PHI/CR2 | DEALER KEY | - | - | - | - |
| | TIIDA | 2007- | PHI/CR2 | DAT-15P3 | TPX4/TPX5 | TPX4/TPX5 | TP12NS | 16 |
| | TITAN | 2004-2016 | PHI/CR2 | DAT-15P3 | TPX4/TPX5 | TPX4/TPX5 | TP12NS | 16 |
| 2016 - | | PHI/CR3 | DEALER KEY | - | - | - | - | |
| VERSA | 2007- | PHI/CR2 | DAT-15P3 | TPX4/TPX5 | TPX4/TPX5 | TP12NS | 16 | |
| | 2007- | PHI/CR2 | DEALER KEY | TPX4/TPX5 | TPX4/TPX5 | TP12NS | 16 | |
| VERSA NOTE | 2014- | PHI/CR3 | DEALER KEY | - | - | - | - | |
| X-TERRA | 2002-2004 | TEX/CR | DAT-15P3 | TPX2/TPX5/TPX6 | TPX2/TPX5/TPX6 | TP19 | 16 | |
| | 2005-2015 | PHI/CR2 | DAT-15P3 | TPX4/TPX5 | TPX4/TPX5 | TP12NS | 16 | |
| X-TRAIL | 2005-2006 | TEX/CR | DAT-15P4 | TPX2/TPX5/TPX6 | TPX2/TPX5/TPX6 | TP19 | 16 | |
| OLDS MOBILE® | AURORA | 2001-2003 | MEG/- | GM-28P | TP05 | TP05 | TP03/TP05** | 4 |
| | SILHOUETTE | 1999-2004 | MEG/- | GM-27P | TP05 | TP05 | TP03/TP05** | 4 |
| OPEL- VAUXHALL® | ADAM | 2013- | PHI/CR2 | OP-11P1 | TPX4/TPX5 | TPX4/TPX5 | TP12GM | 8 |
| | AGILA A | 2000-2000 | PHI/CR | OP-10P | - | - | TP09 | 8 |
| | | 2000-2004 | PHI/CR | OP-10P | - | - | TP09 | 8 |
| | | 2004-2008 | PHI/CR | OP-11P1 | - | - | TP09 | 8 |
| | | 2008-2014 | PHI/CR2 | SUZU-14P2 | TPX4/TPX5 | TPX4/TPX5 | TP12GM | 17 |
| | AGILA A (D) | 2008-2014 | PHI/CR | OP-10P | - | - | TP09 | 8 |
| | AMPERA | 2012- | PHI/CR2 | OP-11P1 | TPX4/TPX5 | TPX4/TPX5 | TP12GM | 8 |
| | ANTARA | 2007-2015 | PHI/CR2 | DAE-4P1 | TPX4/TPX5 | TPX4/TPX5 | TP12GM | 2 |
| | ASTRA | 1995-1998 | PHI/- | OP-DP | TP01/TP05 | TP01/TP05 | TP01/TP05** | 9 |
| | | 1995-1998 | PHI/- | OP-SP | TP01/TP05 | TP01/TP05 | TP01/TP05** | 9 |
| | ASTRA G | 1998-2004 | PHI/CR | OP-DP | - | - | TP09 | 9 |
| | | 1998-2004 | PHI/CR | OP-SP | - | - | TP09 | 9 |
| | | 1998-2004 | PHI/CR | OP-STL | - | - | TP09 | 9 |
| | ASTRA H | 2004-2010 | PHI/CR2 | OP-11P1 | TPX4/TPX5 | TPX4/TPX5 | TP12GM | 8 |
| | | 2004-2010 | PHI/CR2 | DEALER KEY | - | - | - | - |
| | ASTRA J | 2010-2015 | PHI/CR2 | OP-11P1 | TPX4/TPX5 | TPX4/TPX5 | TP12GM | 8 |
| | ASTRA K | 2015- | PHI/CR3 | ORIGINAL | - | - | - | - |
| | CABRIO | 2013- | PHI/CR2 | OP-11P1 | TPX4/TPX5 | TPX4/TPX5 | TP12GM | 8 |
| | CALIBRA | 1995-1998 | PHI/- | OP-WHP | TP01/TP05 | TP01/TP05 | TP01/TP05** | 10 |
| | | 1995-1998 | PHI/- | OP-WYP | TP01/TP05 | TP01/TP05 | TP01/TP05** | 10 |
| | CASCADA | 2013- | PHI/CR2 | OP-11P1 | TPX4/TPX5 | TPX4/TPX5 | TP12GM | 8 |
| | COMBO | 1998-2002 | PHI/- | OP-SP | TP01/TP05 | TP01/TP05 | TP01/TP05** | 9 |
| | | 1998-2002 | PHI/- | NE-38P4 | TP01/TP05 | TP01/TP05 | TP01/TP05** | 15 |
| 2002-2004 | | PHI/CR | OP-SP | - | - | TP09 | 9 | |
| 2002-2004 | | PHI/CR | OP-STL2 | - | - | TP09 | 9 | |

AUTOMÓVIL - CAMIONETA





CAR-PICK UP TRUCK





| FOR: |  |  |  |  | TRS-5000 EVO | EVO XPERT | Programming TP |  |
|-----------|---|---|---|---|-----------------|--------------|-------------------|---|
| | | 2004-2008 | PHI/CR | OP-11TL2 | | | TP09 | 9 |
| | | 2004-2011 | PHI/CR | OP-11P1 | | | TP09 | 8 |
| | | 2012-2017 | PHI/CR2 | FI-16P | TPX4/TPX5 | TPX4/TPX5 | TP12 | 20 |
| CORSA B | | 1995-1998 | PHI/- | OP-DP | TP01/TP05 | TP01/TP05 | TP01/TP05** | 9 |
| | | 1995-1998 | PHI/- | OP-SP | TP01/TP05 | TP01/TP05 | TP01/TP05** | 9 |
| | | 1998-2000 | PHI/CR | OP-SP | | | TP09 | 9 |
| | | 1998-2000 | PHI/CR | OP-STL | | | TP09 | 9 |
| | | 2000-2004 | PHI/CR | OP-SP | | | TP09 | 9 |
| | | 2000-2004 | PHI/CR | OP-STL2 | | | TP09 | 9 |
| CORSA C | | 2004-2006 | PHI/CR | OP-11P1 | | | TP09 | 8 |
| | | 2004-2006 | PHI/CR | OP-11TL2 | | | TP09 | 9 |
| CORSA D | | 2006-2013 | PHI/CR2 | OP-11P1 | TPX4/TPX5 | TPX4/TPX5 | TP12GM | 8 |
| CORSA E | | 2014- | PHI/CR2 | OP-11P1 | TPX4/TPX5 | TPX4/TPX5 | TP12GM | 8 |
| FRONTERA | | 1996-1999 | MEG/- | GM-4P1 | TP05 | TP05 | TP03/TP05** | 4 |
| | | 1999-2003 | MEG/CR | HOND-21P | TPX8+ | TPX8+ | TP08 | 4 |
| INSIGNA | | 2008- | PHI/CR2 | OP-11P1 | TPX4/TPX5 | TPX4/TPX5 | TP12GM | 8 |
| MERIVA | | 2002-2004 | PHI/CR | OP-STL2 | | | - | 9 |
| | | 2002-2004 | PHI/CR | OP-SP | | | TP09 | 9 |
| | | 2004-2010 | PHI/CR | OP-11TL | | | TP09 | 9 |
| | | 2004-2010 | PHI/CR | OP-11TL2 | | | TP09 | 9 |
| | | 2010- | PHI/CR2 | OP-11P1 | TPX4/TPX5 | TPX4/TPX5 | TP12GM | 8 |
| MOKKA | | 2012- | PHI/CR2 | OP-11P1 | TPX4/TPX5 | TPX4/TPX5 | TP12GM | 8 |
| | | 2012- | PHI/CR2 | ORIGINAL | | | - | |
| MOVANO | | 1998-2001 | PHI/- | NE-38P4 | TP05 | TP05 | TP01/TP05** | 15 |
| | | 2002-2010 | PHI/CR2 | NE-38P4 | TPX4/TPX5 | TPX4/TPX5 | TP12RN | 15 |
| | | 2011-2014 | PHI/CR2 | CIT-1P | TPX4/TPX5 | TPX4/TPX5 | TP12RN | 21 |
| | | 2015- | PHI/CR3 | ORIGINAL | | | - | |
| OMEGA | | 1995-1998 | PHI/- | OP-WHP | TP01/TP05 | TP01/TP05 | TP01/TP05** | 10 |
| | | 1995-1998 | PHI/- | OP-WYP | TP01/TP05 | TP01/TP05 | TP01/TP05** | 10 |
| | | 1998-1999 | PHI/CR | OP-DP | | | TP09 | 9 |
| | | 1998-1999 | PHI/CR | OP-SP | | | TP09 | 9 |
| | | 1998-2003 | PHI/CR | OP-WHP | | | TP09 | 10 |
| | | 1998-2003 | PHI/CR | OP-WHTL | | | TP09 | 10 |
| SIGNUM | | 2003-2005 | PHI/CR2 | OP-WHP | TPX4/TPX5 | TPX4/TPX5 | TP12GM | 10 |
| | | 2003-2008 | PHI/CR2 | OP-11P1 | TPX4/TPX5 | TPX4/TPX5 | TP12GM | 8 |
| SINTRA | | 1997-1999 | PHI/- | OP-WHP | TP01/TP05 | TP01/TP05 | TP01/TP05** | 10 |
| SPEEDSTER | | 2001-2005 | PHI/CR | OP-SP | | | TP09 | 9 |
| | | 2001-2005 | PHI/CR | OP-STL | | | TP09 | 9 |
| TIGRA | | 1995-1998 | PHI/- | OP-DP | TP01/TP05 | TP01/TP05 | TP01/TP05** | 9 |
| | | 1995-1998 | PHI/- | OP-SP | TP01/TP05 | TP01/TP05 | TP01/TP05** | 9 |
| | | 1998-2002 | PHI/CR | OP-SP | | | TP09 | 9 |
| | | 1998-2002 | PHI/CR | OP-STL | | | TP09 | 9 |
| | | 1998-2002 | PHI/CR | OP-DTL | | | - | 9 |
| TIGRA B | | 2004- | PHI/CR | OP-11P1 | | | TP09 | 8 |
| | | 2004- | PHI/CR | OP-11TL2 | | | TP09 | 9 |
| VECTRA | | 1995-1998 | PHI/- | OP-WHP | TP01/TP05 | TP01/TP05 | TP01/TP05** | 10 |
| | | 1995-1998 | PHI/- | OP-WYP | TP01/TP05 | TP01/TP05 | TP01/TP05** | 10 |
| | | 1998-2001 | PHI/CR | OP-WHP | | | TP09 | 10 |
| | | 1998-2001 | PHI/CR | OP-WHTL | | | TP09 | 10 |
| | | 2002-2004 | PHI/CR | OP-SP | | | TP09 | 9 |

| FOR: |  |  |  |  | TRS-5000 EVO | EVO XPERT | Programming TP |  |
|-----------------|---|---|---|---|-----------------|----------------|-------------------|---|
| | | 2002-2004 | PHI/CR | OP-STL | | | TP09 | 9 |
| | | 2002-2005 | PHI/CR2 | OP-WHP | TPX4/TPX5 | TPX4/TPX5 | TP12GM | 10 |
| | | 2004-2008 | PHI/CR2 | OP-11P1 | TPX4/TPX5 | TPX4/TPX5 | TP12GM | 8 |
| | VIVARO | 2002- | PHI/CR2 | NE-38P4 | TPX4/TPX5 | TPX4/TPX5 | TP12RN | 15 |
| | ZAFIRA | 1999-2001 | PHI/CR | OP-WHP | | | TP09 | 10 |
| | | 1999-2001 | PHI/CR | OP-WHTL | | | TP09 | 10 |
| | | 2001-2005 | PHI/CR | OP-SP | | | TP09 | 9 |
| | | 2001-2005 | PHI/CR | OP-STL | | | TP09 | 9 |
| | | 2005-2013 | PHI/CR2 | OP-11P1 | TPX4/TPX5 | TPX4/TPX5 | TP12GM | 8 |
| | | 2007-2013 | PHI/CR2 | DEALER KEY | | | - | |
| | | 2013 - | PHI/CR2 | OP-11P1 | | | - | 8 |
| PANOZ® | AIV ROADSTER | 1995- | TEX/- | FO-16P | TPX1/TPX6/TPX5 | TPX1/TPX6/TPX5 | TP02 | 3 |
| | | 1996-2000 | TEX/- | FO-15DP | TPX1/TPX6/TPX5 | TPX1/TPX6/TPX5 | TP02 | 16 |
| | ESPERANTE | 2001-2006 | TEX/- | FO-15DP | TPX1/TPX6/TPX5 | TPX1/TPX6/TPX5 | TP02 | 8 |
| | | 2007-2010 | TEX/CR | FO-30DP | TPX2/TPX5/TPX6 | TPX2/TPX5/TPX6 | TP20 | 3 |
| PERODUA® | KELISA | 2001-2007 | TEX/- | DAI-3P1 | TPX1/TPX6/TPX5 | TPX1/TPX6/TPX5 | TP07 | 3 |
| | KEMBARA | 1998-2008 | TEX/- | DAI-1P1 | TPX1/TPX6/TPX5 | TPX1/TPX6/TPX5 | TP07 | 3 |
| | | 1998-2008 | TEX/- | TOYO-20DP | TPX1/TPX6/TPX5 | TPX1/TPX6/TPX5 | TP07 | 19 |
| | KENARI | 2001-2009 | TEX/- | DAI-3P1 | TPX1/TPX6/TPX5 | TPX1/TPX6/TPX5 | TP07 | 3 |
| | MYVI | 2006- | TEX/CR | TOYO-20DP | TPX2/TPX5/TPX6 | TPX2/TPX5/TPX6 | TP30 | 19 |
| | | 2006- | TEX/CR | ORIGINAL | | | - | |
| | NAUTICA | 2007-2010 | TEX/CR | TOYO-20DP | TPX2/TPX5/TPX6 | TPX2/TPX5/TPX6 | TP30 | 19 |
| | | 2007-2010 | TEX/CR | ORIGINAL | | | - | |
| | VIVA | 2007-2014 | TEX/CR | TOYO-20DP | TPX2/TPX5/TPX6 | TPX2/TPX5/TPX6 | TP30 | 19 |
| PEUGEOT® | 106 | 1997-2000 | PHI/- | NE-36P2 | TP01/TP05 | TP01/TP05 | TP01/TP05** | 15 |
| | | 2000-2004 | PHI/CR2 | NE-36P2 | TPX4/TPX5 | TPX4/TPX5 | TP12 | 15 |
| | 107 | 2005- | TEX/CR | CIT-1P | TPX2/TPX5/TPX6 | TPX2/TPX5/TPX6 | TP35 | 21 |
| | 108 | 2014- | TEX/AES | KI-7P | | TPAE1 | - | 13 |
| | 206 | 1998-2000 | PHI/CR | NE-36P2 | TPH1 | TPH1 | TP16 | 15 |
| | | 2001-2009 | PHI/CR2 | NE-36P2 | TPX4/TPX5 | TPX4/TPX5 | TP12 | 15 |
| | 206 CABRIO | 2001-2002 | PHI/CR | NE-36P2 | TPH1 | TPH1 | TP16 | 15 |
| | | 2002-2007 | PHI/CR2 | NE-36P2 | TPX4/TPX5 | TPX4/TPX5 | TP12 | 15 |
| | 206 PLUS | 2009- | PHI/CR2 | NE-36P2 | TPX4/TPX5 | TPX4/TPX5 | TP12 | 15 |
| | 207 | 2006-2015 | PHI/CR2 | HU-HCAP | TPX4/TPX5 | TPX4/TPX5 | TP12 | 8 |
| | 208 | 2012-2017 | PHI/CR2 | HU-HCAP | TPX4/TPX5 | TPX4/TPX5 | TP12 | 8 |
| | | 2017- | PHI/CR3 | ORIGINAL | | | - | |
| | 301 | 2013-2016 | PHI/CR2 | HU-HCAP | TPX4/TPX5 | TPX4/TPX5 | TP12 | 8 |
| | 306 | 1997-2002 | PHI/- | NE-36P2 | TP01/TP05 | TP01/TP05 | TP01/TP05** | 15 |
| | 307 | 2001-2009 | PHI/CR2 | HU-HCAP | TPX4/TPX5 | TPX4/TPX5 | TP12 | 8 |
| | 308 | 2007-2017 | PHI/CR2 | HU-HCAP | TPX4/TPX5 | TPX4/TPX5 | TP12 | 8 |
| | | 2017- | PHI/CR3 | ORIGINAL | | | - | |
| | 406 | 1997-1999 | PHI/- | NE-51P2 | TP01/TP05 | TP01/TP05 | TP01/TP05** | 15 |
| | | 1999-2002 | PHI/CR | NE-51P2 | TPH1 | TPH1 | TP16 | 15 |
| | | 2002-2004 | PHI/CR2 | NE-51P2 | TPX4/TPX5 | TPX4/TPX5 | TP12 | 15 |
| | 407 | 2004-2011 | PHI/CR2 | CIT-1P | TPX4/TPX5 | TPX4/TPX5 | TP12 | 21 |
| | 408 | 2010- | PHI/CR2 | HU-HCAP | TPX4/TPX5 | TPX4/TPX5 | TP12 | 8 |
| | 508 | 2011-2015 | PHI/CR2 | CIT-1P | TPX4/TPX5 | TPX4/TPX5 | TP12 | 21 |
| | | 2011-2015 | PHI/CR2 | DEALER KEY | | | - | |
| | 607 | 2001-2004 | MEG/CR | NE-51P2 | TPX8+ | TPX8+ | TP08 | 15 |
| | | 2004-2010 | PHI/CR2 | NE-51P2 | TPX4/TPX5 | TPX4/TPX5 | TP12 | 15 |

AUTOMÓVIL - CAMIONETA





CAR-PICK UP TRUCK





| FOR: |  |  |  |  | TRS-5000 EVO | EVO XPERT | Programming TP |  |
|------------------|---|---|---|---|-----------------|----------------|-------------------|---|
| | 806 | 1998-2002 | PHI/- | SIX-3P3 | TP01/TP05 | TP01/TP05 | TP01/TP05** | 16 |
| | 807 | 2002-2014 | PHI/CR2 | HU-HCAP | TPX4/TPX5 | TPX4/TPX5 | TP12 | 8 |
| | 1007 | 2004-2010 | PHI/CR2 | CIT-1P | TPX4/TPX5 | TPX4/TPX5 | TP12 | 21 |
| | 2008 | 2013-2017 | PHI/CR2 | HU-HCAP | TPX4/TPX5 | TPX4/TPX5 | TP12 | 8 |
| | | 2017- | PHI/CR3 | ORIGINAL | | | - | |
| | 3008 | 2009-2015 | PHI/CR2 | HU-HCAP | TPX4/TPX5 | TPX4/TPX5 | TP12 | 8 |
| | | 2016- | PHI/CR3 | ORIGINAL | | | - | |
| | | 2016- | PHI/CR3 | DEALER KEY | | | - | |
| | 4007 | 2007-2012 | PHI/CR2 | MIT-8DP2 | TPX4/TPX5 | TPX4/TPX5 | TP12 | 14 |
| | | 2007-2012 | PHI/CR2 | DEALER KEY | | | - | |
| | 4008 | 2012-2017 | PHI/CR2 | MIT-8DP2 | TPX4/TPX5 | TPX4/TPX5 | TP12 | 14 |
| | 5008 | 2009-2015 | PHI/CR2 | HU-HCAP | TPX4/TPX5 | TPX4/TPX5 | TP12 | 8 |
| | | 2009-2015 | PHI/CR2 | DEALER KEY | | | - | |
| | | 2016- | PHI/CR3 | ORIGINAL | | | - | |
| | | 2016- | PHI/CR3 | DEALER KEY | | | - | |
| | BIPPER | 2009- | PHI/CR2 | FI-16P | TPX4/TPX5 | TPX4/TPX5 | TP12 | 20 |
| | BOXER | 1996-2001 | MEG/- | FI-11P5 | TP05 | TP05 | TP03/TP05** | 19 |
| | | 2002-2010 | MEG/CR | FI-16P | TPX8+ | TPX8+ | TP08 | 20 |
| | | 2009- | PHI/CR2 | FI-16P | TPX4/TPX5 | TPX4/TPX5 | TP12 | 20 |
| | EXPERT | 1997-2001 | PHI/- | SIX-3P3 | TP01/TP05 | TP01/TP05 | TP01/TP05** | 16 |
| | | 2002-2006 | PHI/CR2 | SIX-3P3 | TPX4/TPX5 | TPX4/TPX5 | TP12 | 16 |
| | | 2007-2016 | PHI/CR2 | HU-HCAP | TPX4/TPX5 | TPX4/TPX5 | TP12 | 8 |
| | | 2016- | PHI/CR3 | ORIGINAL | | | - | |
| | ION | 2011- | PHI/CR2 | MIT-8DP2 | TPX4/TPX5 | TPX4/TPX5 | TP12 | 14 |
| | PARTNER | 1998-2001 | PHI/- | SIX-3P3 | TP01/TP05 | TP01/TP05 | TP01/TP05** | 16 |
| | | 2001-2002 | PHI/CR2 | SIX-3P3 | TPX4/TPX5 | TPX4/TPX5 | TP12 | 16 |
| | | 2002- | PHI/CR2 | CIT-1P | TPX4/TPX5 | TPX4/TPX5 | TP12 | 21 |
| | RANCH | 1998-2001 | PHI/- | SIX-3P3 | TP01/TP05 | TP01/TP05 | TP01/TP05** | 16 |
| | | 2001-2002 | PHI/CR2 | SIX-3P3 | TPX4/TPX5 | TPX4/TPX5 | TP12 | 16 |
| | | 2002-2007 | PHI/CR2 | CIT-1P | TPX4/TPX5 | TPX4/TPX5 | TP12 | 21 |
| | RCZ | 2010-2015 | PHI/CR2 | HU-HCAP | TPX4/TPX5 | TPX4/TPX5 | TP12 | 8 |
| | TRAVELLER | 2016- | PHI/CR3 | ORIGINAL | | | - | |
| PLYMOUTH® | BREEZE | 1999-2000 | TEX/CR | CHR-15P | TPX2/TPX5/TPX6 | TPX2/TPX5/TPX6 | TP21 | 1 |
| | GRAND VOYAGER | 2001-2003 | TEX/CR | CHR-15P | TPX2/TPX5/TPX6 | TPX2/TPX5/TPX6 | TP21 | 1 |
| | NEON | 2000-2001 | TEX/CR | CHR-15P | TPX2/TPX5/TPX6 | TPX2/TPX5/TPX6 | TP21 | 1 |
| | PROWLER | 2000-2002 | TEX/CR | CHR-15P | TPX2/TPX5/TPX6 | TPX2/TPX5/TPX6 | TP21 | 1 |
| | VOYAGER | 2001-2002 | TEX/CR | CHR-15P | TPX2/TPX5/TPX6 | TPX2/TPX5/TPX6 | TP21 | 1 |
| PONTIAC® | AZTEK | 2001-2005 | MEG/- | GM-28P | TP05 | TP05 | TP03/TP05** | 4 |
| | BONNEVILLE | 2000-2005 | MEG/- | GM-28P | TP05 | TP05 | TP03/TP05** | 4 |
| | G3 | 2010-2010 | MEG/CR | DAE-3DP4 | TPM1 | TPM1 | TP08 | 1 |
| | G5 | 2007-2010 | PHI/CR2 | GM-37P | TPX4/TPX5 | TPX4/TPX5 | TP12GM | 4 |
| | G6 | 2005-2010 | PHI/CR2 | GM-37P | TPX4/TPX5 | TPX4/TPX5 | TP12GM | 4 |
| | G8 | 2008-2009 | PHI/CR2 | OP-11TL | TPX4/TPX5 | TPX4/TPX5 | TP12GM | 9 |
| | GRAND PRIX | 2000-2003 | MEG/- | GM-43P | TP05 | TP05 | TP03/TP05** | 4 |
| | | 2004-2008 | MEG/- | GM-37P | TP05 | TP05 | TP03/TP05** | 4 |
| | MONTANA | 1999-2004 | MEG/- | GM-27P | TP05 | TP05 | TP03/TP05** | 4 |
| | MONTANA V6 | 2005-2005 | MEG/- | GM-37P | TP05 | TP05 | TP03/TP05** | 4 |
| | | 2005-2006 | MEG/- | GM-28P | TP05 | TP05 | TP03/TP05** | 4 |
| | MONTANA V6 (CAN) | 2007-2009 | MEG/- | GM-28P | TP05 | TP05 | TP03/TP05** | 4 |
| | PURSUIT | 2006-2010 | PHI/CR2 | GM-37P | TPX4/TPX5 | TPX4/TPX5 | TP12GM | 4 |

| FOR: |  |  |  |  | TRS-5000 EVO | EVO XPERT | Programming TP |  |
|-------------------|---|---|---|---|-----------------|----------------|--------------------|---|
| | SOLSTICE | 2006-2009 | PHI/CR2 | GM-37P | TPX4/TPX5 | TPX4/TPX5 | TP12GM | 4 |
| | TORRENT | 2007-2009 | PHI/CR2 | GM-37P | TPX4/TPX5 | TPX4/TPX5 | TP12GM | 4 |
| | TRANS SPORT | 1999- | MEG/- | GM-27P | TP05 | TP05 | TP03/TP05** | 4 |
| | VIBE | 2009-2010 | TEX/CR | TOYO-15P | TPX2/TPX5/TPX6 | TPX2/TPX5/TPX6 | TP30 | 18 |
| | WAVE | 2005-2010 | MEG/CR | DAE-3DP1 | TPX8+ | TPX8+ | TP08 | 1 |
| PORSCHE® | 911 | 1998-1999 | MEG/- | HU-HAAP1 | TP01/TP05 | TP01/TP05 | TP03/TP05** | 7 |
| | | 1999-2004 | MEG/CR | HU-HAAP1 | TPX8+ | TPX8+ | TP08 | 7 |
| | | 2004-2008 | PHI/CR2 | ORIGINAL | | | - | |
| | 968 | 1995-1999 | MEG/CR | ORIGINAL | | | - | |
| | BOXSTER | 1997-1998 | MEG/- | HU-HAAP1 | TP05 | TP05 | TP03/TP05** | 7 |
| | | 1999-2004 | MEG/CR | HU-HAAP1 | TPX8+ | TPX8+ | TP08 | 7 |
| | | 2005-2011 | MEG/CR | ORIGINAL | | | - | |
| | CAYENNE | 2003-2010 | PHI/CR2 | HU-HAAP1 | TPX4/TPX5 | TPX4/TPX5 | TP12 | 7 |
| | CAYMAN | 2006-2009 | MEG/CR | ORIGINAL | | | - | |
| | | 2009-2012 | PHI/CR2 | HU-HAAP1 | TPX4/TPX5 | TPX4/TPX5 | TP12 | 7 |
| GT3 | 2004-2007 | MEG/CR | ORIGINAL | | | - | | |
| PANAMERA | 2011- | PHI/CR2 | ORIGINAL | | | - | | |
| PORSCHE® (USA) | 968 | 1999-2005 | MEG/CR | HU-HAAP1 | TPX8+ | TPX8+ | TP08 | 7 |
| | BOXSTER | 1997-1998 | MEG/- | HU-HAAP1 | TP05 | TP05 | TP03/TP05** | 7 |
| | CAYENNE | 2003-2010 | MEG/CR | HU-HAAP1 | TPX8+ | TPX8+ | TP08 | 7 |
| PROTON® | 415 | 1996-1998 | TEX/- | | PRO-1P | TPX1/TPX6/TPX5 | TPX1/TPX6/ TPX5 | TP07 |
| | | 1998-2002 | TEM/CR | ORIGINAL | | | - | |
| | | 416 | 1996-1998 | TEX/- | | PRO-1P | TPX1/TPX6/TPX5 | TPX1/TPX6/ TPX5 |
| | | 1998-2002 | TEM/CR | ORIGINAL | | | - | |
| | EXORA | 2009-2012 | MEG/CR | PRO-1P | TPX8+ | TPX8+ | TP08 | 16 |
| | GEN.2 | 2004-2012 | MEG/CR | PRO-1P | TPX8+ | TPX8+ | TP08 | 16 |
| | JUMBUCK | 2002-2010 | MEG/CR | PRO-1P | TPX8+ | TPX8+ | TP08 | 16 |
| | PERSONA | 2007- | MEG/CR | PRO-1P | TPX8+ | TPX8+ | TP08 | 16 |
| | SAGA | 2008-2010 | MEG/CR | PRO-1P | TPX8+ | TPX8+ | TP08 | 16 |
| | SAVVY | 2005-2011 | MEG/CR | PRO-1P | TPX8+ | TPX8+ | TP08 | 16 |
| WIRA | 2002-2009 | MEG/CR | PRO-1P | TPX8+ | TPX8+ | TP08 | 16 | |
| RENAULT® | AVANTIME | 2001-2003 | TEX/CR | NE-38P4 | TPX2/TPX5/TPX6 | TPX2/TPX5/TPX6 | TP19 | 15 |
| | CLIO I | 1995-1998 | PHI/- | VA-34P4 | TP01/TP05 | TP01/TP05 | TP01/TP05** | 20 |
| | CLIO II FASE1 | 1998-2001 | PHI/- | NE-38P4 | TP01/TP05 | TP01/TP05 | TP01/TP05** | 15 |
| | | 2001-2005 | PHI/CR2 | NE-38P4 | TPX4/TPX5 | TPX4/TPX5 | TP12RN | 15 |
| | CLIO II FASE2 | 2001-2012 | PHI/CR2 | NE-36P2 | TPX4/TPX5 | TPX4/TPX5 | TP12RN | 15 |
| | | 2006-2012 | PHI/CR2 | CIT-1P | TPX4/TPX5 | TPX4/TPX5 | TP12RN | 21 |
| | CLIO III | 2006-2012 | PHI/CR2 | DEALER KEY | | | - | |
| | | 2006-2012 | PHI/CR2 | ORIGINAL | | | - | |
| | CLIO IV | 2012- | PHI/CR3 | ORIGINAL | | | - | |
| | ESPACE III | 1997-2002 | PHI/- | NE-38P4 | TP01/TP05 | TP01/TP05 | TP01/TP05** | 15 |
| | ESPACE IV | 2002-2014 | PHI/CR2 | DEALER KEY | | | - | |
| | ESPACE V | 2015- | PHI/CR3 | DEALER KEY | | | - | |
| | FLUENCE | 2009-2016 | PHI/CR2 | CIT-1P | TPX4/TPX5 | TPX4/TPX5 | TP12RN | 21 |
| | | 2009-2016 | PHI/CR2 | DEALER KEY | | | - | |
| KANGOO | 1997-2001 | PHI/- | VA-34P4 | TP01/TP05 | TP01/TP05 | TP01/TP05** | 20 | |
| | 2002-2008 | PHI/CR2 | VA-34P4 | TPX4/TPX5 | TPX4/TPX5 | TP12RN | 20 | |
| | 2008- | PHI/CR2 | CIT-1P | TPX4/TPX5 | TPX4/TPX5 | TP12RN | 21 | |
| LAGUNA I | 1995-2000 | PHI/- | NE-38P4 | TP01/TP05 | TP01/TP05 | TP01/TP05** | 15 | |

AUTOMÓVIL - CAMIONETA





CAR-PICK UP TRUCK





| FOR: |  |  |  |  | TRS-5000 EVO | EVO XPERT | Programming TP |  |
|---------------------------|---|---|---|---|-----------------|----------------|-------------------|---|
| | | 1995-2000 | PHI/- | VA-34P4 | TP01/TP05 | TP01/TP05 | TP01/TP05** | 20 |
| | | 1999-2000 | TEX/CR | NE-38P4 | TPX2/TPX5/TPX6 | TPX2/TPX5/TPX6 | TP19 | 15 |
| | LAGUNA II | 2001-2007 | PHI/CR2 | DEALER KEY | | | - | |
| | LATITUDE | 2010- | PHI/CR2 | DEALER KEY | | | - | |
| | MASTER | 1998-2001 | PHI/- | NE-38P4 | TP01/TP05 | TP01/TP05 | TP01/TP05** | 15 |
| | | 2002-2010 | PHI/CR2 | NE-36P2 | TPX4/TPX5 | TPX4/TPX5 | TP12RN | 15 |
| | | 2002-2010 | PHI/CR2 | NE-38P4 | TPX4/TPX5 | TPX4/TPX5 | TP12RN | 15 |
| | | 2011-2014 | PHI/CR2 | CIT-1P | TPX4/TPX5 | TPX4/TPX5 | TP12RN | 21 |
| | | 2014- | PHI/CR3 | ORIGINAL | | | - | |
| | MAXITY | 2007- | PHI/CR2 | DAT-15P2 | TPX4/TPX5 | TPX4/TPX5 | TP12NS | 15 |
| | MEGANE I | 1996-1998 | PHI/- | NE-38P4 | TP01/TP05 | TP01/TP05 | TP01/TP05** | 15 |
| | | 1998-2000 | TEX/CR | NE-38P4 | TPX2/TPX5/TPX6 | TPX2/TPX5/TPX6 | TP21 | 15 |
| | | 2000-2002 | TEX/CR | NE-38P4 | TPX2/TPX5/TPX6 | TPX2/TPX5/TPX6 | TP19 | 15 |
| | MEGANE II | 2002-2008 | PHI/CR2 | DEALER KEY | | | - | |
| | MEGANE IV | 2016- | PHI/CR3 | DEALER KEY | | | - | |
| | MODUS | 2004-2012 | PHI/CR2 | CIT-1P | TPX4/TPX5 | TPX4/TPX5 | TP12RN | 21 |
| | | 2004-2012 | PHI/CR2 | DEALER KEY | | | - | |
| | SAFRANE | 1995-2002 | PHI/- | NE-38P4 | TP01/TP05 | TP01/TP05 | TP01/TP05** | 15 |
| | SCENIC I | 1996-1998 | PHI/- | NE-38P4 | TP01/TP05 | TP01/TP05 | TP01/TP05** | 15 |
| | | 1998-2000 | TEX/CR | NE-38P4 | TPX2/TPX5/TPX6 | TPX2/TPX5/TPX6 | TP21 | 15 |
| | | 2000-2003 | TEX/CR | NE-38P4 | TPX2/TPX5/TPX6 | TPX2/TPX5/TPX6 | TP19 | 15 |
| | SCENIC II | 2003-2008 | PHI/CR2 | DEALER KEY | | | - | |
| | SCENIC IV | 2016- | PHI/CR3 | DEALER KEY | | | - | |
| | TALISMAN | 2015- | PHI/CR3 | DEALER KEY | | | - | |
| | THALIA | 2001-2008 | PHI/CR2 | NE-38P4 | TPX4/TPX5 | TPX4/TPX5 | TP12RN | 15 |
| | TRAFIC | 2002-2014 | PHI/CR2 | NE-36P2 | TPX4/TPX5 | TPX4/TPX5 | TP12RN | 15 |
| | | 2002-2014 | PHI/CR2 | NE-38P4 | TPX4/TPX5 | TPX4/TPX5 | TP12RN | 15 |
| | | 2014- | PHI/CR3 | ORIGINAL | | | - | |
| | TWINGO | 1995-2001 | PHI/- | VA-34P4 | TP01/TP05 | TP01/TP05 | TP01/TP05** | 20 |
| | | 2002-2007 | PHI/CR2 | VA-34P4 | TPX4/TPX5 | TPX4/TPX5 | TP12RN | 20 |
| | | 2007-2014 | PHI/CR2 | CIT-1P | TPX4/TPX5 | TPX4/TPX5 | TP12RN | 21 |
| | | 2014- | PHI/CR3 | ORIGINAL | | | - | |
| | TWIZY | 2011- | PHI/CR2 | DAC-4DP | TPX4/TPX5 | TPX4/TPX5 | TP12RN | 1 |
| RENAULT DACIA® | DOKKER | 2012- | PHI/CR2 | DAC-4DP | TPX4/TPX5 | TPX4/TPX5 | TP12RN | 1 |
| | DUSTER | 2010-2013 | PHI/CR2 | VA-34P4 | TPX4/TPX5 | TPX4/TPX5 | TP12RN | 20 |
| | | 2013- | PHI/CR3 | DAC-6DP | | | - | 1 |
| | | 2013- | PHI/CR3 | ORIGINAL | | | - | |
| | LOGGY | 2012- | PHI/CR2 | DAC-4DP | TPX4/TPX5 | TPX4/TPX5 | TP12RN | 1 |
| | LOGAN | 2004-2012 | PHI/CR2 | DAC-4DP | TPX4/TPX5 | TPX4/TPX5 | TP12RN | 1 |
| | | 2004-2012 | PHI/CR2 | VA-34P4 | TPX4/TPX5 | TPX4/TPX5 | TP12RN | 20 |
| | | 2012-2015 | PHI/CR3 | ORIGINAL | | | - | |
| | | 2012-2016 | PHI/CR3 | DAC-6DP | | | - | 1 |
| | | 2016- | PHI/CR3 | ORIGINAL | | | ORIGINAL | |
| | SANDERO | 2008-2013 | PHI/CR2 | DAC-4DP | TPX4/TPX5 | TPX4/TPX5 | TP12RN | 1 |
| | | 2008-2013 | PHI/CR2 | VA-34P4 | TPX4/TPX5 | TPX4/TPX5 | - | 20 |
| | | 2013- | PHI/CR3 | DAC-6DP | | | - | 1 |
| | | 2013- | PHI/CR3 | ORIGINAL | | | - | |
| | SOLENZA | 1998-2000 | PHI/- | DAC-3DP4 | TP01/TP05 | TP01/TP05 | TP01/TP05** | 1 |
| | | 2002-2005 | PHI/CR2 | DAC-3DP4 | | | - | 1 |

| FOR: |  |  |  |  | TRS-5000 EVO | EVO XPERT | Programming TP |  |
|-------------------------|---|---|---|---|-----------------|----------------|-------------------|---|
| ROVER [®] | SYMBOL | 2010-2013 | PHI/CR2 | NE-36P2 | TPX4/TPX5 | TPX4/TPX5 | TP12RN | 15 |
| | | 2010-2013 | PHI/CR2 | VA-34P4 | TPX4/TPX5 | TPX4/TPX5 | TP12RN | 20 |
| | SYMBOL III | 2013- | PHI/CR3 | ORIGINAL | | | - | |
| | 45 | 1999-2005 | PHI/EVO. | ORIGINAL | | | - | |
| | 75 | 2004-2005 | PHI/EVO. | ORIGINAL | | | - | |
| | 400 | 1997-1998 | PHI/- | NE-35P3 | TP01/TP05 | TP01/TP05 | TP01/TP05** | 5 |
| | 600 | 1998- | PHI/- | NE-35P3 | TP01/TP05 | TP01/TP05 | TP01/TP05** | 5 |
| | 618 | 1996-1999 | PHI/- | NE-35P3 | TP01/TP05 | TP01/TP05 | TP01/TP05** | 5 |
| SAAB [®] | 620 | 1996-1999 | PHI/- | NE-35P3 | TP01/TP05 | TP01/TP05 | TP01/TP05** | 5 |
| | 800 | 1997-1998 | PHI/- | NE-35P3 | TP01/TP05 | TP01/TP05 | TP01/TP05** | 5 |
| | 9-2X | 2005-2008 | TEX/CR | ORIGINAL | | | - | |
| | 9-3 | 1998-2003 | MEG/- | SAA-1P | TP05SA | TP05SA | TP03/TP05** | 16 |
| | | 1998-2003 | SAAB/- | ORIGINAL | | | - | |
| | | 2003-2013 | PHI/CR2 | ORIGINAL | | | - | |
| | 9-4X | 2010-2011 | PHI/CR2 | ORIGINAL | | | - | |
| | 9-5 | 1998-2003 | MEG/- | SAA-1P | TP05SA | TP05SA | TP03/TP05** | 16 |
| 1998-2002 | | SAAB/- | ORIGINAL | | | - | | |
| 2003-2009 | | PHI/CR2 | ORIGINAL | | | - | | |
| SAAB [®] (USA) | 9-3 | 1999-2003 | MEG/- | SAA-1P | TP05SA | TP05SA | TP03/TP05** | 16 |
| | | 2004-2011 | PHI/CR2 | ORIGINAL | | | - | |
| | 9-5 | 1999-2003 | MEG/- | SAA-1P | TP05SA | TP05SA | TP03/TP05** | 16 |
| | | 2004-2009 | SAAB/- | SAA-3P | | | - | 16 |
| 97X | 2006-2009 | MEG/- | GM-37P | TP05 | TP05 | TP03/TP05** | 4 | |
| SATURN [®] | ASTRA | 2008-2009 | PHI/CR2 | OP-11P1 | TPX4/TPX5 | TPX4/TPX5 | TP12GM | 8 |
| | AURA | 2007-2010 | PHI/CR2 | GM-37P | TPX4/TPX5 | TPX4/TPX5 | TP12GM | 4 |
| | OUTLOOK | 2007-2010 | PHI/CR2 | GM-37P | TPX4/TPX5 | TPX4/TPX5 | TP12GM | 4 |
| | RELAY | 2005-2005 | MEG/- | GM-37P | TP05 | TP05 | TP03/TP05** | 4 |
| | | 2005-2007 | MEG/- | GM-27P | TP05 | TP05 | TP03/TP05** | 4 |
| | SKY | 2007-2010 | PHI/CR2 | GM-37P | TPX4/TPX5 | TPX4/TPX5 | TP12GM | 4 |
| VUE | 2008-2010 | PHI/CR2 | DAE-4DP2 | TPX4/TPX5 | TPX4/TPX5 | TP12GM | 2 | |
| SCION [®] | FR-S | 2013-2016 | TEX/DST80 | TOYO-15P | | | - | 18 |
| | | 2013-2016 | TEX/DST80 | DEALER KEY | | | - | |
| | iA | 2016- | PHI/CR3 | DEALER KEY | | | - | |
| | iM | 2016- | TEX/AES | KI-7P | | TPAE1 | - | 13 |
| | IQ (CAN) | 2012-2013 | TEX/DST80 | TOYO-15P | TPG1 | TPG1 | TP34 | 18 |
| | TC | 2005-2010 | TEX/CR | TOYO-15P | TPX2/TPX5/TPX6 | TPX2/TPX5/TPX6 | TP30 | 18 |
| | | 2011-2015 | TEX/DST80 | TOYO-15P | TPG1 | TPG1 | TP34 | 18 |
| | | 2014-2014 | TEX/DST80 | ORIGINAL | | | - | |
| | XA | 2004-2007 | TEX/CR | TOYO-15P | TPX2/TPX5/TPX6 | TPX2/TPX5/TPX6 | TP30 | 18 |
| | XB | 2004-2008 | TEX/CR | TOYO-15P | TPX2/TPX5/TPX6 | TPX2/TPX5/TPX6 | - | 18 |
| XB (CAN) | 2011-2012 | TEX/DST80 | TOYO-15P | TPG1 | TPG1 | TP34 | 18 | |
| XD | 2008-2008 | TEX/CR | TOYO-15P | TPX2/TPX5/TPX6 | TPX2/TPX5/TPX6 | TP30 | 18 | |
| XD (CAN) | 2011-2012 | TEX/DST80 | TOYO-15P | TPG1 | TPG1 | TP34 | 18 | |
| SEAT [®] | ALHAMBRA | 1996-1998 | PHI/- | HU-HAAP1 | TP01/TP05 | TP01/TP05 | TP01/TP05** | 7 |
| | | 1998-2000 | PHI/CR | HU-HAAP1 | TPH1 | TPH1 | TP10 | 7 |
| | | 1998-2000 | PHI/CR | HU-HAATLV | TPH1 | TPH1 | TP10 | 8 |
| | | 2000-2005 | PHI/CR | HU-HAAP1 | TPH1 | TPH1 | TP14 | 7 |
| | | 2000-2005 | PHI/CR | HU-HAATLN | TPH1 | TPH1 | TP14 | 8 |
| | | 2006-2010 | MEG/CR | HU-HAAP1 | TPX8+ | TPX8+ | TP08 | 7 |

AUTOMÓVIL - CAMIONETA





CAR-PICK UP TRUCK





| FOR: |  |  |  |  | TRS-5000 EVO | EVO XPERT | Programming TP |  | |
|----------------|---|---|---|---|-----------------|--------------|-------------------|---|-----------------|
| ALTEA | 2010-2015 | MEG/CR | HU-HAAP1 | | TPX8+ | TPX8+ | TP22* | 7 | |
| | 2016- | MEG/AES | ORIGINAL | | | | - | | |
| | 2004-2005 | MEG/CR | HU-HAAP1 | | TPX8+ | TPX8+ | TP08 | 7 | |
| | 2004-2015 | MEG/CR | HU-HAAP1 | | TPX8+ | TPX8+ | TP22* | 7 | |
| | 2007-2015 | MEG/CR | HU-HAAP1 | | TPX8+ | TPX8+ | TP22* | 10 | |
| | 2004-2015 | MEG/CR | HU-HAATLN | | | | - | 8 | |
| | ALTEA XL4 | 2006-2015 | MEG/CR | HU-HAAP1 | | TPX8+ | TPX8+ | TP22* | 7 |
| | AROSA | 1997-1999 | PHI/- | HU-HAAP1 | | TP01/TP05 | TP01/TP05 | TP01/TP05** | 7 |
| | | 1999-2001 | PHI/CR | HU-HAAP1 | | TPH1 | TPH1 | TP10 | 7 |
| | | 2001-2005 | PHI/CR | HU-HAAP1 | | TPH1 | TPH1 | TP14 | 7 |
| | CORDOBA | 1995-1998 | PHI/- | VO-2P | | TP01/TP05 | TP01/TP05 | TP01/TP05** | 10 |
| | | 1999-2002 | PHI/CR | HU-HAAP1 | | TPH1 | TPH1 | TP10 | 7 |
| | | 2002-2009 | MEG/CR | HU-HAAP1 | | TPX8+ | TPX8+ | TP08 | 7 |
| | EXEO | 2008-2013 | MEG/CR | HU-HAAP1 | | TPX8+ | TPX8+ | TP22* | 7 |
| | FREETRACK | 2008-2015 | MEG/CR | HU-HAAP1 | | TPX8+ | TPX8+ | TP22* | 7 |
| | IBIZA | 1995-1998 | PHI/- | VO-2P | | TP01/TP05 | TP01/TP05 | TP01/TP05** | 10 |
| | | 1998-2002 | PHI/CR | HU-HAAP1 | | TPH1 | TPH1 | TP10 | 7 |
| | | 1999-2008 | MEG/CR | HU-HAAP1 | | TPX8+ | TPX8+ | TP08 | 7 |
| | | 2008-2017 | MEG/CR | HU-HAAP1 | | TPX8+ | TPX8+ | TP22* | 7 |
| | | 2017- | MEG/AES | ORIGINAL | | | | - | |
| | INCA | 1996-1998 | PHI/- | VO-2P | | TP01/TP05 | TP01/TP05 | TP01/TP05** | 10 |
| | | 1998-2000 | PHI/CR | HU-HAAP1 | | TPH1 | TPH1 | TP10 | 7 |
| | | 2000-2003 | PHI/CR | HU-HAAP1 | | TPH1 | TPH1 | TP14 | 7 |
| | LEON | 1999-2005 | MEG/CR | HU-HAAP1 | | TPX8+ | TPX8+ | TP08 | 7 |
| | | 2005-2012 | MEG/CR | HU-HAAP1 | | TPX8+ | TPX8+ | TP22* | 7 |
| | | 2012- | MEG/AES | ORIGINAL | | | | - | |
| MARBELLA | | 1997-1998 | PHI/- | VO-2P | | TP05 | TP05 | TP05 | TP01/ TP05** |
| MII | 1997-1998 | TEM/- | VO-2P | | TP05 | TP05 | TP05 | 10 | |
| | 2012-2016 | MEG/CR | HU-HAAP1 | | TPX8+ | TPX8+ | TP22* | 7 | |
| TOLEDO | 1995-1998 | PHI/- | VO-2P | | TP01/TP05 | TP01/TP05 | TP01/TP05** | 10 | |
| | 1998-2004 | MEG/CR | HU-HAAP1 | | TPX8+ | TPX8+ | TP08 | 7 | |
| | 2004-2009 | MEG/CR | HU-HAATLN | | TPX8+ | TPX8+ | TP22* | 8 | |
| | 2004-2009 | MEG/CR | HU-HAAP1 | | TPX8+ | TPX8+ | TP22* | 7 | |
| | 2009- | MEG/CR | HU-HAAP1 | | TPX8+ | TPX8+ | TP22* | 7 | |
| | 2013- | MEG/AES | ORIGINAL | | | | - | | |
| VARIO | 1997-1998 | PHI/- | VO-2P | | TP01/TP05 | TP01/TP05 | TP01/TP05** | 10 | |
| | 1998-1999 | PHI/CR | HU-HAAP1 | | TPH1 | TPH1 | TP10 | 7 | |
| VARIOS MODELOS | 2014- | MEG/AES | HU-5P | | | | - | 7 | |
| | 2014- | MEG/AES | HU-6P | | | | - | 7 | |
| | 1999-2002 | MEG/CR | HU-HAAP1 | | TPX8+ | TPX8+ | TP08 | 7 | |
| SKODA® | CITIGO | 2012- | MEG/CR | HU-HAAP1 | | TPX8+ | TP24* | 7 | |
| | FABIA | 1999-2007 | MEG/CR | HU-HAAP1 | | TPX8+ | TP08 | 7 | |
| | | 2000-2007 | MEG/CR | HU-HAATLN | | TPX8+ | TP08 | 8 | |
| | | 2007-2014 | MEG/CR | HU-HAAP1 | | TPX8+ | TP24* | 7 | |
| | | 2014- | MEG/AES | HU-5P | | | | - | 7 |
| | 2014- | MEG/AES | ORIGINAL | | | | - | | |
| FELICIA | 1996-1998 | PHI/- | SKO-5P1 | | TP05 | TP05 | TP01/TP05** | 3 | |
| | 1998-2001 | PHI/- | HU-HAAP1 | | TP05 | TP05 | TP01/TP05** | 7 | |
| | 1999-2001 | MEG/CR | HU-HAAP1 | | TPX8+ | TPX8+ | TP08 | 7 | |
| LAURA | 2007-2012 | MEG/CR | HU-HAAP1 | | TPX8+ | TPX8+ | TP24* | 7 | |

| FOR: |  |  |  |  | TRS-5000 EVO | EVO XPERT | Programming TP |  |
|------------------------|---|---|---|---|-----------------|----------------|-------------------|---|
| | OCTAVIA | 1997-2001 | MEG/- | HU-HAAP | TP05 | TP05 | TP03/TP05** | 7 |
| | | 1998-2004 | MEG/CR | HU-HAAP1 | TPX8+ | TPX8+ | TP08 | 7 |
| | | 2004-2012 | MEG/CR | HU-HAAP1 | TPX8+ | TPX8+ | TP24* | 7 |
| | | 2013- | MEG/AES | ORIGINAL | | | - | |
| | PICK-UP | 1995-1998 | PHI/- | SKO-5P1 | TP01 | TP01 | TP01/TP05** | 3 |
| | | 1998-2000 | PHI/- | HU-HAAP | TP05 | TP05 | TP01/TP05** | 7 |
| | PRAKTIK | 2007-2015 | MEG/CR | HU-HAAP1 | TPX8+ | TPX8+ | TP24* | 7 |
| | RAPID | 2012-2013 | MEG/CR | HU-HAAP1 | TPX8+ | TPX8+ | TP24* | 7 |
| | | 2013- | MEG/AES | HU-5P | | | - | 7 |
| | | 2013- | MEG/AES | HU-6P | | | - | 7 |
| | | 2013- | MEG/AES | ORIGINAL | | | - | |
| | ROOMSTER | 2006-2015 | MEG/CR | HU-HAAP1 | TPX8+ | TPX8+ | TP24 | 7 |
| | ROOMSTER SCOUT | 2007-2015 | MEG/CR | HU-HAAP1 | TPX8+ | TPX8+ | TP24 | 7 |
| SUPER B | 2001-2008 | MEG/CR | HU-HAAP1 | TPX8+ | TPX8+ | TP08 | 7 | |
| | 2001-2008 | MEG/CR | HU-HAATLN | TPX8+ | TPX8+ | TP08 | 8 | |
| | 2008-2015 | MEG/CR | HU-HAAP1 | TPX8+ | TPX8+ | TP24* | 7 | |
| YETI | 2009-2017 | MEG/CR | HU-HAAP1 | TPX8+ | TPX8+ | TP24* | 7 | |
| SMART [®] | CITY COUPE | 1999-2003 | -/- | ORIGINAL | | | - | |
| | CROSSBLADE | 2002-2003 | -/- | ORIGINAL | | | - | |
| | FORFOUR | 2004-2006 | PHI/CR2 | SMR-1P | TPX4/TPX5 | TPX4/TPX5 | TP12 | 16 |
| | | 2004-2006 | PHI/CR2 | ORIGINAL | | | - | |
| | | 2014- | PHI/CR3 | ORIGINAL | | | - | |
| | FORTWO | 2007-2014 | PHI/CR2 | SMR-1P | TPX4/TPX5 | TPX4/TPX5 | TP12 | 16 |
| 2014- | | PHI/CR3 | ORIGINAL | | | - | | |
| ROADSTER | 2003-2006 | -/- | ORIGINAL | | | - | | |
| SSANGYONG [®] | ACTYON | 2007-2012 | TEX/CR | SSA-1P1 | TPX2/TPX5/TPX6 | TPX2/TPX5/TPX6 | TP19 | 16 |
| | | 2007-2012 | TEX/CR | ORIGINAL | | | - | |
| | | 2008-2012 | MEG/CR | SAA-1P1 | TPX8+ | TPX8+ | TP08 | 16 |
| | KORANDO | 1998-2010 | TEM/- | ME-HMP1 | TP05 | TP05 | TP05 | 21 |
| | | 2010-2012 | TEX/DST80 | ORIGINAL | | | - | |
| | | 2013- | SOK/CR | ORIGINAL | | | - | |
| | KYRON | 2005-2012 | TEX/CR | SSA-1P1 | TPX2/TPX5/TPX6 | TPX2/TPX5/TPX6 | TP19 | 16 |
| | | 2005-2012 | TEX/CR | ORIGINAL | | | - | |
| | | 2012- | MEG/CR | SAA-1P1 | | | TP08 | 16 |
| | | 2012- | TEX/CR | ORIGINAL | | | - | |
| | MUSSO | 1997- | PHI/- | ME-HMP1 | TP01/TP05 | TP01/TP05 | TP01/TP05** | 21 |
| | | 2001-2005 | MEG/CR | ORIGINAL | TPX8+ | TPX8+ | TP08 | |
| | REXTON | 2001-2005 | MEG/CR | ORIGINAL | TPX8+ | TPX8+ | TP08 | |
| | | 2006-2012 | TEX/CR | SSA-1P1 | TPX2/TPX5/TPX6 | TPX2/TPX5/TPX6 | TP19 | 16 |
| | | 2008-2012 | MEG/CR | SSA-1P1 | TPX8+ | TPX8+ | TP08 | 16 |
| 2013- | | SOK/CR | ORIGINAL | | | TP32 | | |
| RODIUS | 2005-2013 | SOK/CR | ORIGINAL | | | TP32 | | |
| SUBARU [®] | ASCENT | 2019- | TEX/AES | ORIGINAL | | | - | |
| | B9 TRIBECA | 2006-2013 | TEX/CR | SUB-3P2 | TPX2/TPX5/TPX6 | TPX2/TPX5/TPX6 | TP28 | 17 |
| | | 2007-2014 | TEX/CR | SUB-2P | TPX2/TPX5/TPX6 | TPX2/TPX5/TPX6 | TP28 | 16 |
| | BAJA | 2005-2007 | TEX/CR | SUB-3P2 | TPX2/TPX5/TPX6 | TPX2/TPX5/TPX6 | TP28 | 17 |
| | EXIGA | 2010-2013 | TEX/CR | SUB-2P | TPX2/TPX5/TPX6 | TPX2/TPX5/TPX6 | TP28 | 16 |
| | FORESTER | 1998-2003 | TEX/CR | SUB-3P2 | TPX2/TPX5/TPX6 | TPX2/TPX5/TPX6 | TP19 | 17 |
| | | 2004-2007 | TEX/CR | SUB-3P2 | TPX2/TPX5/TPX6 | TPX2/TPX5/TPX6 | TP28 | 17 |
| | | 2008-2010 | TEX/CR | SUB-2P | TPX2/TPX5/TPX6 | TPX2/TPX5/TPX6 | TP28 | 16 |

AUTOMÓVIL - CAMIONETA





CAR-PICK UP TRUCK





| FOR: |  |  |  |  | TRS-5000 EVO | EVO XPERT | Programming TP |  |
|----------------------|---|---|---|---|-----------------|----------------|-------------------|---|
| | | 2011-2013 | TEX/CR | SUB-2P | TPX2/TPX5/TPX6 | TPX2/TPX5/TPX6 | - | 16 |
| | | 2013-2015 | TEX/DST80 | DEALER KEY | | | - | |
| | | 2013-2018 | TEX/DST80 | TOYO-15P | | | - | 18 |
| | | 2013-2018 | TEX/DST80 | ORIGINAL | | | - | |
| SUBARU® (USA) | | 2019- | TEX/AES | TOYO-15P | | | - | 18 |
| | | 2019- | TEX/AES | ORIGINAL | | | - | |
| SUBARU® | G3X JUSTY | 2004-2007 | TEX/CR | OP-10P | TPX2/TPX5/TPX6 | TPX2/TPX5/TPX6 | TP27 | 8 |
| | IMPREZA | 1996-2000 | PHI/- | DAT-6P2 | TP01/TP05 | TP01/TP05 | TP01/TP05** | 15 |
| | | 1998-2003 | TEX/CR | SUB-3P2 | TPX2/TPX5/TPX6 | TPX2/TPX5/TPX6 | TP19 | 17 |
| | | 2004-2007 | TEX/CR | SUB-3P2 | TPX2/TPX5/TPX6 | TPX2/TPX5/TPX6 | TP28 | 17 |
| | | 2007-2010 | TEX/CR | SUB-2P | TPX2/TPX5/TPX6 | TPX2/TPX5/TPX6 | TP28 | 16 |
| | | 2011-2012 | TEX/CR | SUB-2P | TPX2/TPX5/TPX6 | TPX2/TPX5/TPX6 | - | 161 |
| | | 2012-2016 | TEX/DST80 | ORIGINAL | | | - | |
| | | 2012-2016 | TEX/DST80 | DEALER KEY | | | - | |
| | | 2017-2019 | TEX/AES | TOYO-15P | | | - | 18 |
| | | 2017-2019 | TEX/AES | ORIGINAL | | | - | |
| | JUSTY | 1996-2003 | TEX/- | SUZU-10P1 | TPX1/TPX6/TPX5 | TPX1/TPX6/TPX5 | TP07 | 17 |
| | LEGACY | 1996-1998 | PHI/- | DAT-6P2 | TP01/TP05 | TP01/TP05 | TP01/TP05** | 15 |
| | | 1998-2003 | TEX/CR | SUB-3P2 | TPX2/TPX5/TPX6 | TPX2/TPX5/TPX6 | TP19 | 17 |
| | | 2003-2005 | TEX/CR | SUB-2P | TPX2/TPX5/TPX6 | TPX2/TPX5/TPX6 | TP19 | 16 |
| | | 2006-2010 | TEX/CR | SUB-2P | TPX2/TPX5/TPX6 | TPX2/TPX5/TPX6 | TP28 | 16 |
| | | 2010-2014 | TEX/CR | SUB-2P | TPX2/TPX5/TPX6 | TPX2/TPX5/TPX6 | - | 16 |
| | | 2014- | TEX/DST80 | TOYO-15P | | | - | 18 |
| | | 2014- | TEX/DST80 | ORIGINAL | | | - | |
| | | 2014- | TEX/DST80 | DEALER KEY | | | - | |
| | LEVORG | 2015- | TEX/DST80 | TOYO-15P | | | - | 18 |
| | | 2015- | TEX/DST80 | ORIGINAL | | | - | |
| | | 2015- | TEX/DST80 | DEALER KEY | | | - | |
| | LIBERTY | 1998-2003 | TEX/CR | DAT-15P2 | TPX2/TPX5/TPX6 | TPX2/TPX5/TPX6 | TP19 | 15 |
| | | 2003-2009 | TEX/CR | SUB-3P2 | TPX2/TPX5/TPX6 | TPX2/TPX5/TPX6 | TP28 | 17 |
| | | 2009-2013 | TEX/CR | SUB-2P | TPX2/TPX5/TPX6 | TPX2/TPX5/TPX6 | TP28 | 16 |
| | OUTBACK | 1996-1998 | PHI/- | DAT-6P2 | TP01/TP05 | TP01/TP05 | TP01/TP05** | 15 |
| | | 1998-2003 | TEX/CR | SUB-3P2 | TPX2/TPX5/TPX6 | TPX2/TPX5/TPX6 | TP19 | 17 |
| | | 2003-2005 | TEX/CR | SUB-2P | TPX2/TPX5/TPX6 | TPX2/TPX5/TPX6 | TP19 | 16 |
| | | 2006-2009 | TEX/CR | SUB-2P | TPX2/TPX5/TPX6 | TPX2/TPX5/TPX6 | TP28 | 16 |
| | | 2010-2014 | TEX/CR | SUB-2P | TPX2/TPX5/TPX6 | TPX2/TPX5/TPX6 | - | 16 |
| | | 2014- | TEX/DST80 | TOYO-15P | | | - | 18 |
| | | 2014- | TEX/DST80 | ORIGINAL | | | - | |
| | | 2014- | TEX/DST80 | DEALER KEY | | | - | |
| | TREZIA | 2011-2014 | TEX/DST80 | TOYO-15P | TPG1 | TPG1 | TP34 | 18 |
| | WRX | 2000- | TEX/CR | SUB-3P2 | TPX2/TPX5/TPX6 | TPX2/TPX5/TPX6 | TP19 | 17 |
| | | 2010-2014 | TEX/CR | SUB-2P | TPX2/TPX5/TPX6 | TPX2/TPX5/TPX6 | - | 16 |
| | | 2015- | TEX/DST80 | TOYO-15P | | | - | 18 |
| | | 2015- | TEX/DST80 | ORIGINAL | | | - | |
| | | 2015- | TEX/DST80 | DEALER KEY | | | - | |
| | XV | 2012-2017 | TEX/DST80 | ORIGINAL | | | - | |
| | | 2012-2017 | TEX/DST80 | DEALER KEY | | | - | |
| | | 2017- | TEX/AES | TOYO-15P | | | - | 18 |
| | | 2017- | TEX/AES | ORIGINAL | | | - | |
| SUBARU® (AUS) | FORESTER | 1998-2004 | TEX/CR | SUB-3P2 | TPX2/TPX5/TPX6 | TPX2/TPX5/TPX6 | TP19 | 17 |

| FOR: |  |  |  |  | TRS-5000 EVO | EVO XPERT | Programming TP |  |
|---------------|---|---|---|---|-----------------|----------------|-------------------|---|
| SUBARU® (USA) | IMPREZA | 1998-2004 | TEX/CR | SUB-3P2 | TPX2/TPX5/TPX6 | TPX2/TPX5/TPX6 | TP19 | 17 |
| | LIBERTY | 1998-2003 | TEX/CR | SUB-3P2 | TPX2/TPX5/TPX6 | TPX2/TPX5/TPX6 | TP19 | 17 |
| | OUTBACK | 1998-2003 | TEX/CR | SUB-3P2 | TPX2/TPX5/TPX6 | TPX2/TPX5/TPX6 | TP19 | 17 |
| | ASCENT | 2019- | TEX/AES | ISU-3DP2 | | | - | |
| | BRZ | 2012- | TEX/DST80 | TOYO-15P | | | - | 18 |
| | | 2012- | TEX/DST80 | ORIGINAL | | | - | |
| | | 2012- | TEX/DST80 | DEALER KEY | | | - | |
| | FORESTER | 2005-2008 | TEX/CR | SUB-3P2 | TPX2/TPX5/TPX6 | TPX2/TPX5/TPX6 | TP28 | 17 |
| | | 2009-2013 | TEX/CR | SUB-2P | TPX2/TPX5/TPX6 | TPX2/TPX5/TPX6 | TP28 | 16 |
| | | 2014-2018 | TEX/CR | DEALER KEY | | | - | |
| | IMPREZA | 2005-2007 | TEX/CR | SUB-3P2 | TPX2/TPX5/TPX6 | TPX2/TPX5/TPX6 | TP28 | 17 |
| | | 2008-2011 | TEX/CR | SUB-2P | TPX2/TPX5/TPX6 | TPX2/TPX5/TPX6 | TP28 | 16 |
| | | 2012-2014 | TEX/DST80 | DEALER KEY | | | - | |
| | IMPREZA WRX | 2008-2014 | TEX/CR | SUB-2P | TPX2/TPX5/TPX6 | TPX2/TPX5/TPX6 | TP28 | 16 |
| | LEGACY | 2005-2009 | TEX/CR | SUB-3P2 | TPX2/TPX5/TPX6 | TPX2/TPX5/TPX6 | TP28 | 17 |
| | | 2010-2014 | TEX/CR | SUB-2P | TPX2/TPX5/TPX6 | TPX2/TPX5/TPX6 | TP28 | 16 |
| 2015-2018 | | TEX/DST80 | DEALER KEY | | | - | | |
| OUTBACK | 2010-2014 | TEX/CR | SUB-2P | TPX2/TPX5/TPX6 | TPX2/TPX5/TPX6 | TP28 | 16 | |
| | 2015-2018 | TEX/DST80 | ORIGINAL | | | - | | |
| OUTBACK / GT | 2005-2009 | TEX/CR | SUB-3P2 | TPX2/TPX5/TPX6 | TPX2/TPX5/TPX6 | TP28 | 17 | |
| TRIBECA B9 | 2006-2013 | TEX/CR | SUB-3P2 | TPX2/TPX5/TPX6 | TPX2/TPX5/TPX6 | TP28 | 17 | |
| XV CROSSTREK | 2015-2018 | TEX/DST80 | DAT-15P4 | | | - | 16 | |
| | 2015-2018 | TEX/DST80 | DEALER KEY | | | - | | |
| SUZUKI® | ALTO | 1996-2002 | TEX/- | SUZU-10P1 | TPX1/TPX6/TPX5 | TPX1/TPX6/TPX5 | TP07 | 17 |
| | | 1996-2002 | TEX/- | SUZU-8P1 | TPX1/TPX6/TPX5 | TPX1/TPX6/TPX5 | TP07 | 17 |
| | | 2002-2008 | TEX/CR | SUZU-8IP1 | TPX2/TPX5/TPX6 | TPX2/TPX5/TPX6 | TP27 | 17 |
| | | 2009-2014 | PHI/CR2 | SUZU-14P2 | TPX4/TPX5 | TPX4/TPX5 | TP12SZ | 17 |
| | BALENO | 1996-2001 | TEX/- | SUZU-10P1 | TPX1/TPX6/TPX5 | TPX1/TPX6/TPX5 | TP07 | 17 |
| | | 1996-2001 | TEX/- | SUZU-8P1 | TPX1/TPX6/TPX5 | TPX1/TPX6/TPX5 | TP07 | 17 |
| | | 2014- | PHI/CR3 | ORIGINAL | | | - | |
| | CELERIO | 2015- | PHI/CR3 | ORIGINAL | | | - | |
| | EQUATOR | 2009-2012 | PHI/CR2 | DAT-15P3 | TPX4/TPX5 | TPX4/TPX5 | TP12NS | 16 |
| | GRAND VITARA | 1996-2002 | TEX/- | SUZU-10P1 | TPX1/TPX6/TPX5 | TPX1/TPX6/TPX5 | TP07 | 17 |
| | | 1996-2002 | TEX/- | SUZU-8P1 | TPX1/TPX6/TPX5 | TPX1/TPX6/TPX5 | TP07 | 17 |
| | | 2002-2008 | PHI/CR2 | SUZU-8P1 | TPX4/TPX5 | TPX4/TPX5 | TP12SZ | 17 |
| | | 2006-2008 | PHI/CR2 | TOYO-15P2 | TPX4/TPX5 | TPX4/TPX5 | TP12SZ | 18 |
| | | 2008-2013 | PHI/CR2 | SUZU-14P2 | TPX4/TPX5 | TPX4/TPX5 | TP12SZ | 17 |
| | | 2011-2013 | PHI/CR2 | DEALER KEY | | | - | |
| | IGNIS | 2000-2000 | PHI/CR | OP-10P | TP05 | TP05 | TP09 | 8 |
| | | 2000-2005 | TEX/CR | OP-10P | TPX2/TPX5/TPX6 | TPX2/TPX5/TPX6 | TP27 | 8 |
| | | 2000-2008 | TEX/CR | SUZU-8P1 | TPX2/TPX5/TPX6 | TPX2/TPX5/TPX6 | TP27 | 17 |
| | | 2003-2008 | TEX/CR | SUZU-14P2 | TPX2/TPX5/TPX6 | TPX2/TPX5/TPX6 | TP27 | 17 |
| | JIMNY | 1999-2002 | TEX/- | SUZU-8P1 | TPX1/TPX6/TPX5 | TPX1/TPX6/TPX5 | TP07 | 17 |
| | | 2002-2006 | PHI/CR | SUZU-8P1 | | | TP09 | 17 |
| | | 2002-2015 | TEX/CR | SUZU-8P1 | TPX2/TPX5/TPX6 | TPX2/TPX5/TPX6 | TP27 | 17 |
| | | 2002-2015 | TEX/CR | SUZU-14P2 | TPX2/TPX5/TPX6 | TPX2/TPX5/TPX6 | TP27 | 17 |
| | JIMNY [D] | 2002-2015 | PHI/CR | SUZU-8P1 | TP05 | TP05 | - | 17 |
| | JIMNY | 2016- | PHI/CR3 | ORIGINAL | | | - | |
| | LIANA | 2001-2005 | TEX/CR | TOYO-15P2 | TPX2/TPX5/TPX6 | TPX2/TPX5/TPX6 | TP27 | 18 |
| 2006-2007 | | TEX/CR | TOYO-15P2 | TPX2/TPX5/TPX6 | TPX2/TPX5/TPX6 | - | 18 | |

AUTOMÓVIL - CAMIONETA





CAR-PICK UP TRUCK





| FOR: |  |  |  |  | TRS-5000 EVO | EVO XPERT | Programming TP |  |
|----------------------------|---|---|---|---|-----------------|----------------|-------------------|---|
| | | 2006-2007 | TEX/CR | ORIGINAL | | | - | |
| | SANTANA | - | PHI/CR2 | SUZU-8P1 | TPX4/TPX5 | TPX4/TPX5 | - | 17 |
| | S-CROSS | 2014- | PHI/CR3 | ORIGINAL | | | - | |
| | SPLASH | 2008-2015 | PHI/CR2 | SUZU-14P2 | TPX4/TPX5 | TPX4/TPX5 | TP12SZ | 17 |
| | | 2010-2015 | PHI/CR2 | DEALER KEY | | | - | |
| | SPLASH [D] | 2008-2015 | PHI/CR | SUZU-14P2 | | | TP09 | 17 |
| | SWIFT | 1996-2005 | TEX/- | SUZU-10P1 | TPX1/TPX6/TPX5 | TPX1/TPX6/TPX5 | TP07 | 17 |
| | | 1996-2005 | TEX/- | SUZU-8P1 | TPX1/TPX6/TPX5 | TPX1/TPX6/TPX5 | TP07 | 17 |
| | | 2005-2007 | TEX/CR | TOYO-15P2 | TPX2/TPX5/TPX6 | TPX2/TPX5/TPX6 | - | 18 |
| | | 2005-2007 | TEX/CR | ORIGINAL | | | - | |
| | SWIFT [D] | 2005- | PHI/CR | SUZU-14P2 | | | TP09 | 17 |
| | SWIFT | 2005- | PHI/CR2 | SUZU-14P2 | TPX4/TPX5 | TPX4/TPX5 | TP12SZ | 17 |
| | | 2005- | PHI/CR2 | DEALER KEY | | | - | |
| | SX4 [D] | 2005- | PHI/CR | SUZU-14P2 | | | TP09 | 17 |
| | SX4 | 2006-2013 | PHI/CR2 | SUZU-14P2 | TPX4/TPX5 | TPX4/TPX5 | TP12SZ | 17 |
| | | 2007-2013 | PHI/CR2 | DEALER KEY | | | - | |
| | VITARA | 1996-2002 | TEX/- | SUZU-10P1 | TPX1/TPX6/TPX5 | TPX1/TPX6/TPX5 | TP07 | 17 |
| | | 1996-2002 | TEX/- | SUZU-8P1 | TPX1/TPX6/TPX5 | TPX1/TPX6/TPX5 | TP07 | 17 |
| | | 2002-2008 | PHI/CR2 | SUZU-8P1 | TPX4/TPX5 | TPX4/TPX5 | TP12SZ | 17 |
| | | 2015- | PHI/CR3 | ORIGINAL | | | - | |
| | WAGON R | 1998-2000 | TEX/- | SUZU-8P1 | TPX1/TPX6/TPX5 | TPX1/TPX6/TPX5 | TP07 | 17 |
| | | 2000-2000 | PHI/CR | OP-10P | TP05 | TP05 | - | 8 |
| | | 2000-2000 | PHI/CR | ORIGINAL | | | - | |
| | | 2000-2008 | PHI/CR | OP-10P | | | TP09 | 8 |
| SUZUKI® (INDIA) | MARUTI 800 | 2007-2010 | TEX/CR | SUZU-17P2 | TPX2/TPX5/TPX6 | TPX2/TPX5/TPX6 | TP27 | 17 |
| | MARUTI A-STAR | 2007- | PHI/CR2 | SUZU-14P2 | TPX4/TPX5 | TPX4/TPX5 | TP12SZ | 17 |
| | MARUTI ALTO | 2007-2010 | TEX/CR | SUZU-8IP1 | TPX2/TPX5/TPX6 | TPX2/TPX5/TPX6 | TP27 | 17 |
| | | 2010- | PHI/CR2 | ORIGINAL | | | - | |
| | MARUTI ALTO K10 | 2010- | PHI/CR2 | SUZU-14P2 | TPX4/TPX5 | TPX4/TPX5 | TP12SZ | 17 |
| | MARUTI ESTEEM | 2007- | TEX/CR | SUZU-17DP2 | TPX2/TPX5/TPX6 | TPX2/TPX5/TPX6 | TP27 | 17 |
| | MARUTI OMNI | 2007-2010 | TEX/CR | SUZU-17DP2 | TPX2/TPX5/TPX6 | TPX2/TPX5/TPX6 | TP27 | 17 |
| | MARUTI RITZ | 2007- | PHI/CR2 | SUZU-14P2 | TPX4/TPX5 | TPX4/TPX5 | TP12SZ | 17 |
| | MARUTI SWIFT | 2007- | PHI/CR2 | SUZU-14P2 | TPX4/TPX5 | TPX4/TPX5 | TP12SZ | 17 |
| | MARUTI SWIFT [D] | 2007-209 | PHI/CR | SUZU-14P2 | | | TP09 | 17 |
| | MARUTI SX4 | 2007- | PHI/CR2 | SUZU-14P2 | TPX4/TPX5 | TPX4/TPX5 | TP12SZ | 17 |
| | MARUTI VERSA | 2007-2010 | TEX/CR | SUZU-8P1 | TPX2/TPX5/TPX6 | TPX2/TPX5/TPX6 | TP27 | 17 |
| | MARUTI WAGON R | 2007-2010 | TEX/CR | SUZU-8P1 | TPX2/TPX5/TPX6 | TPX2/TPX5/TPX6 | TP27 | 17 |
| | | 2010- | PHI/CR2 | SUZU-14P2 | TPX4/TPX5 | TPX4/TPX5 | TP12SZ | 17 |
| | MARUTI ZEN ESTILO | 2007-2010 | TEX/CR | SUZU-8P1 | TPX2/TPX5/TPX6 | TPX2/TPX5/TPX6 | TP27 | 17 |
| | | 2010- | PHI/CR2 | ORIGINAL | | | - | |
| SUZUKI® (JAPON) | ESCUDO | 1996-2002 | TEX/- | SUZU-10P1 | TPX1/TPX6/TPX5 | TPX1/TPX6/TPX5 | TP07 | 17 |
| | | 1996-2002 | TEX/- | SUZU-8P1 | TPX1/TPX6/TPX5 | TPX1/TPX6/TPX5 | TP07 | 17 |
| | KIZASHI | 2011-2013 | PHI/CR2 | DEALER KEY | | | - | |
| SUZUKI® (USA) | EQUATOR | 2009-2012 | PHI/CR2 | DAT-15P3 | TPX4/TPX5 | TPX4/TPX5 | TP12NS | 16 |
| | FORENZA | 2004-2008 | MEG/CR | DAE-3DP1 | | | - | 1 |
| | RENO | 2005-2008 | PHI/CR2 | DAE-3DP4 | TPX4/TPX5 | TPX4/TPX5 | TP12NS | 1 |
| | VERONA | 2004-2007 | PHI/CR2 | DAE-4DP2 | TPX4/TPX5 | TPX4/TPX5 | TP12GM | 2 |
| | GRAND VITARA | 2010-2013 | PHI/CR2 | DEALER KEY | | | - | |

| FOR: |  |  |  |  | TRS-5000 EVO | EVO XPERT | Programming TP |  |
|---------------------------|---|---|---|---|-----------------|----------------|-------------------|---|
| | XL7 | 2007-2009 | PHI/CR2 | GM-37P | TPX4/TPX5 | TPX4/TPX5 | TP12GM | 4 |
| TAGAZ[®] | ROAD PARTNER | 2001-2005 | MEG/CR | ORIGINAL | | | TP08 | |
| TATA[®] | ARIA | 2010- | PHI/CR2 | TAT-1DP2 | TPX4/TPX5 | TPX4/TPX5 | TP12 | 18 |
| | GRAND SAFARI | 1999-2006 | TEM/- | SUZU-17DP2 | TP05 | TP05 | TP05 | 17 |
| | | 1999-2006 | TEM/- | ORIGINAL | | | - | |
| | INDICA VISTA | 2008- | PHI/CR2 | TAT-1DP2 | TPX4/TPX5 | TPX4/TPX5 | TP12 | 18 |
| | INDIGO Ecs | 2008-2014 | PHI/CR2 | TAT-1DP2 | TPX4/TPX5 | TPX4/TPX5 | TP12 | 18 |
| | MANZA | 2009-2014 | PHI/CR2 | TAT-1DP2 | TPX4/TPX5 | TPX4/TPX5 | TP12 | 18 |
| | SAFARI | 1999-2006 | TEM/- | TAT-2DP1 | TP05 | TP05 | TP05 | 18 |
| | | 1999-2006 | TEM/- | ORIGINAL | | | - | |
| | TIAGO | 2016- | -/- | ORIGINAL | | | - | |
| VISTA | 2010-2016 | PHI/CR2 | TAT-1DP2 | TPX4/TPX5 | TPX4/TPX5 | TP12 | 18 | |
| TOYOTA[®] | 4 RUNNER | 1999-2002 | TEX/- | TOYO-15P | TPX1/TPX6/TPX5 | TPX1/TPX6/TPX5 | TP07 | 18 |
| | ALPHARD | 2005-2011 | TEX/CR | TOYO-15P | TPX2/TPX5/TPX6 | TPX2/TPX5/TPX6 | TP30 | 18 |
| | AURIS | 2006-2012 | TEX/CR | TOYO-15P | TPX2/TPX5/TPX6 | TPX2/TPX5/TPX6 | TP30 | 18 |
| | | 2009-2012 | TEX/DST80 | TOYO-15P | TPG1 | TPG1 | TP34 | 18 |
| | AURIS (EU) | 2007-2012 | TEX/CR | TOYO-19P | TPX2/TPX5/TPX6 | TPX2/TPX5/TPX6 | TP35 | 19 |
| | | 2007-2012 | TEX/CR | DEALER KEY | | | - | |
| | | 2009-2012 | TEX/DST80 | TOYO-19P | TPG1 | TPG1 | - | 19 |
| | | 2013-2018 | TEX/AES | ORIGINAL | | TPAE1 | TP36 | |
| | AVANZA | 2004-2011 | TEX/CR | TOYO-15P | TPX2/TPX5/TPX6 | TPX2/TPX5/TPX6 | TP30 | 18 |
| | AVENTIS | 1998-2000 | TEX/- | TOYO-19P | TPX1/TPX6/TPX5 | TPX1/TPX6/TPX5 | TP07 | 19 |
| | | 2000-2003 | TEX/CR | TOYO-19P | TPX2/TPX5/TPX6 | TPX2/TPX5/TPX6 | TP19 | 19 |
| | | 2003-2010 | TEX/CR | TOYO-19P | TPX2/TPX5/TPX6 | TPX2/TPX5/TPX6 | TP35 | 19 |
| | | 2003-2011 | TEX/CR | TOYO-15P | TPX2/TPX5/TPX6 | TPX2/TPX5/TPX6 | TP30 | 18 |
| | | 2010-2012 | TEX/DST80 | TOYO-19P | TPG1 | TPG1 | - | 19 |
| | | 2010-2012 | TEX/DST80 | ORIGINAL | | | - | |
| | AVENTIS VERSO | 2012-2015 | TEX/DST80 | ORIGINAL | TPG1 | TPG1 | - | |
| | | 2001-2003 | TEX/- | TOYO-15P | TPX1/TPX6/TPX5 | TPX1/TPX6/TPX5 | TP07 | 18 |
| | AYGO | 2004-2009 | TEX/CR | TOYO-15P | TPX2/TPX5/TPX6 | TPX2/TPX5/TPX6 | TP30 | 18 |
| | | 2005-2014 | TEX/CR | CIT-1P | TPX2/TPX5/TPX6 | TPX2/TPX5/TPX6 | TP35 | 21 |
| | C-HR | 2014- | TEX/AES | KI-7P | | TPAE1 | TP36 | 13 |
| | | 2016- | TEX/AES | DEALER KEY | | | - | |
| | CAMRY | 1996-2005 | TEX/- | TOYO-15P | TPX1/TPX6/TPX5 | TPX1/TPX6/TPX5 | TP07 | 18 |
| | | 2006-2011 | TEX/CR | TOYO-15P | TPX2/TPX5/TPX6 | TPX2/TPX5/TPX6 | TP30 | 18 |
| | | 2006-2011 | TEX/CR | DEALER KEY | | | - | |
| | | 2011-2015 | TEX/DST80 | TOYO-15P | TPG1 | TPG1 | TP34 | 18 |
| | | 2015- | TEX/AES | KI-7P | | TPAE1 | TP36 | 13 |
| | CARINA | 1996-2000 | PHI/- | TOYO-15P | TP01/TP05 | TP01/TP05 | TP01/TP05** | 18 |
| | | 1996-2000 | TEX/- | TOYO-19P | TPX1/TPX6/TPX5 | TPX1/TPX6/TPX5 | TP07 | 19 |
| | CELICA | 1996-2000 | PHI/- | TOYO-15P | TP01/TP05 | TP01/TP05 | TP01/TP05** | 18 |
| 2000-2005 | | TEX/- | TOYO-15P | TPX1/TPX6/TPX5 | TPX1/TPX6/TPX5 | TP07 | 18 | |
| CENTURY | 1998-2004 | TEX/- | TOYO-15P | TPX1/TPX6/TPX5 | TPX1/TPX6/TPX5 | TP07 | 18 | |
| | 1998-2004 | TEX/- | TOYO-18P | TPX1/TPX6/TPX5 | TPX1/TPX6/TPX5 | TP07 | 18 | |
| COROLLA | 1996-1999 | TEX/- | TOYO-15P | TPX1/TPX6/TPX5 | TPX1/TPX6/TPX5 | TP02 | 19 | |
| | 1996-1999 | TEX/- | TOYO-17P | TPX1/TPX6/TPX5 | TPX1/TPX6/TPX5 | TP02 | 18 | |
| | 1996-2006 | TEX/- | TOYO-15P | TPX1/TPX6/TPX5 | TPX1/TPX6/TPX5 | TP07 | 18 | |
| | 1999-2006 | TEX/CR | TOYO-19P | TPX2/TPX5/TPX6 | TPX2/TPX5/TPX6 | TP07 | 19 | |
| | 1999-2006 | TEX/- | TOYO-15P | TPX1/TPX6/TPX5 | TPX1/TPX6/TPX5 | TP07 | 18 | |
| | 2004-2009 | TEX/CR | TOYO-19P | TPX2/TPX5 | TPX2/TPX5 | TP35 | 19 | |

AUTOMÓVIL - CAMIONETA





CAR-PICK UP TRUCK





| FOR: |  |  |  |  | TRS-5000 EVO | EVO XPERT | Programming TP |  |
|-------------------|---|---|---|---|-----------------|----------------|-------------------|---|
| | | 2007-2010 | TEX/CR | TOYO-15P | TPX2/TPX5/TPX6 | TPX2/TPX5/TPX6 | TP30 | 18 |
| | | 2009-2013 | TEX/DST80 | TOYO-15P | TPG1 | TPG1 | TP34 | 18 |
| | | 2013-2018 | TEX/AES | ORIGINAL | | TPAE1 | TP36 | |
| COROLLA VERSO | | 2001-2004 | TEX/- | TOYO-15P | TPX1/TPX6/TPX5 | TPX1/TPX6/TPX5 | TP07 | 18 |
| | | 2005-2010 | TEX/CR | DEALER KEY | | | - | |
| ECHO | | 1999-2005 | TEX/- | TOYO-20DP | TPX1/TPX6/TPX5 | TPX1/TPX6/TPX5 | TP07 | 19 |
| ECHO VERSO | | 2002-2005 | TEX/- | TOYO-15P | TPX1/TPX6/TPX5 | TPX1/TPX6/TPX5 | TP07 | 18 |
| FJ CRUISER | | 2007-2010 | TEX/CR | TOYO-15P | TPX2/TPX5/TPX6 | TPX2/TPX5/TPX6 | TP30 | 18 |
| | | 2011-2015 | TEX/DST80 | TOYO-15P | TPG1 | TPG1 | TP34 | 18 |
| FORTUNER | | 2007-2009 | TEX/CR | TOYO-15P | TPX2/TPX5/TPX6 | TPX2/TPX5/TPX6 | TP30 | 18 |
| | | 2009-2015 | TEX/DST80 | TOYO-15P | TPG1 | TPG1 | TP34 | 18 |
| GT 86 | | 2012- | TEX/DST80 | TOYO-15P | | | - | 18 |
| HIACE | | 1995-2006 | TEX/- | TOYO-15P | TPX1/TPX6/TPX5 | TPX1/TPX6/TPX5 | TP07 | 18 |
| | | 2007-2010 | TEX/CR | TOYO-15P | TPX2/TPX5/TPX6 | TPX2/TPX5/TPX6 | TP30 | 18 |
| | | 2010-2014 | TEX/DST80 | TOYO-15P | TPG1 | TPG1 | TP34 | 18 |
| | | 2014- | TEX/AES | TOYO-15P | | TPAE1 | TP36 | 18 |
| HILUX | | 1999-2004 | TEX/- | TOYO-15P | TPX1/TPX6/TPX5 | TPX1/TPX6/TPX5 | TP07 | 18 |
| | | 2005-2009 | TEX/CR | TOYO-15P | TPX2/TPX5/TPX6 | TPX2/TPX5/TPX6 | TP30 | 19 |
| | | 2009-2015 | TEX/DST80 | TOYO-15P | TPG1 | TPG1 | TP34 | 18 |
| | | 2016- | TEX/AES | TOYO-15P | | TPAE1 | TP36 | 18 |
| INNOVA | | 2009-2015 | TEX/DST80 | TOYO-15P | TPG1 | TPG1 | TP34 | 18 |
| INNOVA KIJANG | | 2005- | TEX/CR | TOYO-15P | TPX2/TPX5/TPX6 | TPX2/TPX5/TPX6 | TP30 | 18 |
| IQ | | 2008-2014 | TEX/CR | TOYO-15P | TPX2/TPX5/TPX6 | TPX2/TPX5/TPX6 | TP30 | 18 |
| KLUGER | | 2014- | TEX/AES | TOYO-15P | | TPAE1 | TP36 | 18 |
| LANDCRUISER 90 | | 1996-2002 | TEX/- | TOYO-15P | TPX1/TPX6/TPX5 | TPX1/TPX6/TPX5 | TP07 | 18 |
| LANDCRUISER 100 | | 1998-2000 | TEX/- | TOYO-18P | TPX1/TPX6/TPX5 | TPX1/TPX6/TPX5 | TP07 | 18 |
| | | 1998-2002 | TEX/- | TOYO-15P | TPX1/TPX6/TPX5 | TPX1/TPX6/TPX5 | TP07 | 18 |
| | | 2000-2002 | TEX/- | TOYO-30P | TPX1/TPX6/TPX5 | TPX1/TPX6/TPX5 | TP07 | 19 |
| | | 2003-2008 | TEX/CR | TOYO-15P | TPX2/TPX5/TPX6 | TPX2/TPX5/TPX6 | TP30 | 18 |
| LANDCRUISER 120 | | 2002-2008 | TEX/CR | TOYO-15P | TPX2/TPX5/TPX6 | TPX2/TPX5/TPX6 | TP30 | 18 |
| LANDCRUISER 200 | | 2008- | TEX/CR | DEALER KEY | | | TP30 | |
| | | 2011-2015 | TEX/DST80 | TOYO-15P | TPG1 | TPG1 | TP34 | 18 |
| | | 2015-2016 | TEX/AES | TOYO-15P | | TPAE1 | TP36 | 18 |
| LANDCRUISER PRADO | | 2002-2008 | TEX/CR | TOYO-15P | TPX2/TPX5/TPX6 | TPX2/TPX5/TPX6 | TP30 | 18 |
| | | 2009-2013 | TEX/DST80 | TOYO-15P | TPG1 | TPG1 | TP34 | 18 |
| MR2 | | 1997-2007 | TEX/- | TOYO-20DP | TPX1/TPX6/TPX5 | TPX1/TPX6/TPX5 | TP07 | 19 |
| PASEO | | 1995-1999 | PHI/- | TOYO-10P1 | TP01/TP05 | TP01/TP05 | TP01/TP05** | 18 |
| PICNIC | | 1996-2003 | TEX/- | TOYO-15P | TPX1/TPX6/TPX5 | TPX1/TPX6/TPX5 | TP07 | 18 |
| | | 2003-2008 | TEX/CR | TOYO-15P | TPX2/TPX5/TPX6 | TPX2/TPX5/TPX6 | TP30 | 18 |
| PREVIA | | 1996-1999 | PHI/- | TOYO-10P1 | TP01/TP05 | TP01/TP05 | TP01/TP05** | 18 |
| | | 2000-2003 | TEX/- | TOYO-15P | TPX1/TPX6/TPX5 | TPX1/TPX6/TPX5 | TP07 | 18 |
| | | 2003-2008 | TEX/CR | TOYO-15P | TPX2/TPX5/TPX6 | TPX2/TPX5/TPX6 | TP30 | 18 |
| PRIUS | | 2000-2003 | TEX/- | TOYO-15P | TPX1/TPX6/TPX5 | TPX1/TPX6/TPX5 | TP07 | 18 |
| | | 2004-2009 | TEX/CR | DEALER KEY | | | - | |
| PROACE | | 2013-2016 | PHI/CR2 | HU-HCAP | TPX4/TPX5 | TPX4/TPX5 | TP12 | 8 |
| | | 2016- | PHI/CR3 | ORIGINAL | | | - | |
| PROACE VERSO | | 2016- | PHI/CR3 | ORIGINAL | | | - | |
| RAV 4 | | 1996-2002 | TEX/- | TOYO-15P | TPX1/TPX6/TPX5 | TPX1/TPX6/TPX5 | TP02 | 18 |
| | | 1996-2004 | TEX/- | TOYO-15P | TPX1/TPX6/TPX5 | TPX1/TPX6/TPX5 | TP07 | 18 |
| | | 2002-2004 | TEX/- | TOYO-15P | | | TP07 | 18 |

| FOR: |  |  |  |  | TRS-5000 EVO | EVO XPERT | Programming TP |  |
|------------------------|---|---|---|---|-----------------|----------------|-------------------|---|
| | | 2003-2010 | TEX/CR | TOYO-15P | TPX2/TPX5/TPX6 | TPX2/TPX5/TPX6 | TP30 | 18 |
| | | 2006-2012 | TEM/CR | DEALER KEY | | | - | |
| | | 2010-2012 | TEX/DST80 | TOYO-15P | TPG1 | TPG1 | TP34 | 18 |
| | | 2012-2016 | TEX/AES | TOYO-15P | | TPAE1 | TP36 | 18 |
| | | 2015- | TEX/AES | KI-7P | | TPAE1 | TP36 | 13 |
| | REIZ | 2005-2009 | TEX/CR | TOYO-15P | TPX2/TPX5/TPX6 | TPX2/TPX5/TPX6 | TP30 | 18 |
| | STARLET | 1997-1999 | PHI/- | TOYO-20DP1 | TP01/TP05 | TP01/TP05 | TP01/TP05** | 19 |
| | T.U.V. | 2003-2006 | TEX/CR | TOYO-15P | TPX2/TPX5/TPX6 | TPX2/TPX5/TPX6 | TP30 | 18 |
| | TARAGO | 2003-2008 | TEX/CR | TOYO-15P | TPX2/TPX5/TPX6 | TPX2/TPX5/TPX6 | TP30 | 18 |
| | URBAN CRUISER | 2009-2014 | TEX/CR | TOYO-15P | TPX2/TPX5/TPX6 | TPX2/TPX5/TPX6 | TP30 | 18 |
| | VERSO | 2009-2013 | TEX/DST80 | TOYO-15P | TPG1 | TPG1 | TP34 | 18 |
| | | 2012-2015 | TEX/DST80 | ORIGINAL | | | - | |
| | VERSO-S | 2011-2014 | TEX/DST80 | TOYO-15P | TPG1 | TPG1 | TP34 | 18 |
| | VIOS | 2007-2013 | TEX/CR | TOYO-15P | TPX2/TPX5/TPX6 | TPX2/TPX5/TPX6 | TP30 | 18 |
| | WISH | 2004-2009 | TEX/CR | TOYO-15P | TPX2/TPX5/TPX6 | TPX2/TPX5/TPX6 | TP30 | 18 |
| | YARIS | 1999-2005 | TEX/- | TOYO-19P | TPX1/TPX6/TPX5 | TPX1/TPX6/TPX5 | TP07 | 19 |
| | | 1999-2005 | TEX/- | TOYO-20DP | TPX1/TPX6/TPX5 | TPX1/TPX6/TPX5 | TP07 | 19 |
| | | 2005-2011 | TEX/CR | TOYO-19P | TPX2/TPX5/TPX6 | TPX2/TPX5/TPX6 | TP35 | 19 |
| | | 2011-2014 | TEX/DST80 | TOYO-15P | TPG1 | TPG1 | TP34 | 18 |
| | 2011-2014 | TEX/DST80 | TOYO-19P | | | - | 19 | |
| | 2011-2014 | TEX/DST80 | ORIGINAL | | | - | | |
| | 2014- | TEX/AES | ORIGINAL | | TPAE1 | TP36 | | |
| | 2014- | TEX/AES | TOYO-15P | | TPAE1 | TP36 | 18 | |
| TOYOTA® (AUSTRALIA) | AURION | 2006-2011 | TEX/CR | TOYO-15P | TPX2/TPX5/TPX6 | TPX2/TPX5/TPX6 | TP30 | 18 |
| | | 2011-2015 | TEX/DST80 | TOYO-15P | TPG1 | TPG1 | TP34 | 18 |
| | | 2015- | TEX/AES | KI-7P | | TPAE1 | TP36 | 13 |
| | | 2015- | TEX/AES | ORIGINAL | | | - | |
| LANDCRUISER 100 | 2002-2005 | TEX/CR | TOYO-30P | TPX2/TPX5/TPX6 | TPX2/TPX5/TPX6 | TP30 | 19 | |
| | 2002-2005 | TEX/CR | ORIGINAL | | | - | | |
| TOYOTA® (JAPON) | ALPHARD | 2003-2005 | TEX/CR | TOYO-15P | TPX2/TPX5/TPX6 | TPX2/TPX5/TPX6 | TP30 | 18 |
| | ARISTO | 1998-2005 | TEX/- | TOYO-30P | TPX1/TPX6/TPX5 | TPX1/TPX6/TPX5 | TP07 | 19 |
| | Bb | 2000-2005 | TEX/CR | TOYO-15P | TPX2/TPX5/TPX6 | TPX2/TPX5/TPX6 | TP30 | 18 |
| | BREVIS | 2001-2007 | TEX/- | TOYO-30P | TPX1/TPX6/TPX5 | TPX1/TPX6/TPX5 | TP07 | 19 |
| | CALDINA | 2002-2004 | TEX/- | TOYO-15P | TPX1/TPX6/TPX5 | TPX1/TPX6/TPX5 | TP07 | 18 |
| | CELSIOR | 1998-2004 | TEX/- | TOYO-18P | TPX1/TPX6/TPX5 | TPX1/TPX6/TPX5 | TP07 | 18 |
| | | 1998-2004 | TEX/- | TOYO-30P | TPX1/TPX6/TPX5 | TPX1/TPX6/TPX5 | TP07 | 19 |
| | COROLLA FIELDER | 2004- | TEX/CR | TOYO-15P | TPX2/TPX5/TPX6 | TPX2/TPX5/TPX6 | TP30 | 18 |
| | COROLLA RUNX | 2004- | TEX/CR | TOYO-15P | TPX2/TPX5/TPX6 | TPX2/TPX5/TPX6 | TP30 | 18 |
| | COROLLA SPACIO | 2003- | TEX/CR | TOYO-15P | TPX2/TPX5/TPX6 | TPX2/TPX5/TPX6 | TP30 | 18 |
| | CROWN | 1999-2005 | TEX/- | TOYO-30P | TPX1/TPX6/TPX5 | TPX1/TPX6/TPX5 | TP07 | 19 |
| | | 2003-2008 | TEX/CR | TOYO-15P | TPX2/TPX5/TPX6 | TPX2/TPX5/TPX6 | TP30 | 18 |
| | DYNA | 2008-2011 | TEX/CR | TOYO-15P | TPX2/TPX5/TPX6 | TPX2/TPX5/TPX6 | TP30 | 18 |
| | ESTIMA | 1997-2001 | PHI/- | TOYO-10P1 | TP01/TP05 | TP01/TP05 | TP01/TP05** | 18 |
| | | 2001-2003 | TEX/- | TOYO-15P | TPX1/TPX6/TPX5 | TPX1/TPX6/TPX5 | TP07 | 18 |
| | | 2003- | TEX/CR | TOYO-15P | TPX2/TPX5/TPX6 | TPX2/TPX5/TPX6 | TP30 | 18 |
| | FUN CARGO | 2003-2005 | TEX/CR | TOYO-15P | TPX2/TPX5/TPX6 | TPX2/TPX5/TPX6 | TP30 | 18 |
| | GAIA | 1999-2004 | TEX/- | TOYO-15P | TPX1/TPX6/TPX5 | TPX1/TPX6/TPX5 | TP07 | 18 |
| | IPSUM | 1996-2003 | TEX/- | TOYO-15P | TPX1/TPX6/TPX5 | TPX1/TPX6/TPX5 | TP07 | 18 |

AUTOMÓVIL - CAMIONETA





CAR-PICK UP TRUCK





| FOR: |  |  |  |  | TRS-5000 EVO | EVO XPERT | Programming TP |  |
|--------------------------------|---|---|---|---|-----------------|----------------|-------------------|---|
| | | 2003- | TEX/CR | TOYO-15P | TPX2/TPX5/TPX6 | TPX2/TPX5/TPX6 | TP30 | 18 |
| | ISIS | 2003- | TEX/CR | TOYO-15P | TPX2/TPX5/TPX6 | TPX2/TPX5/TPX6 | TP30 | 18 |
| | IST | 2003- | TEX/CR | TOYO-15P | TPX2/TPX5/TPX6 | TPX2/TPX5/TPX6 | TP30 | 18 |
| | KLUGER | 2001-2003 | TEX/- | TOYO-15P | TPX1/TPX6/TPX5 | TPX1/TPX6/TPX5 | TP07 | 18 |
| | | 2003-2007 | TEX/CR | TOYO-15P | TPX2/TPX5/TPX6 | TPX2/TPX5/TPX6 | TP30 | 18 |
| | LANDCRUISER PRADO | 2000-2002 | TEX/- | TOYO-15P | TPX1/TPX6/TPX5 | TPX1/TPX6/TPX5 | TP07 | 18 |
| | | 2000-2002 | TEX/- | TOYO-30P | TPX1/TPX6/TPX5 | TPX1/TPX6/TPX5 | TP07 | 19 |
| | | 2002-2005 | TEX/CR | TOYO-15P | TPX2/TPX5/TPX6 | TPX2/TPX5/TPX6 | TP30 | 18 |
| | MAJESTA | 2003-2008 | TEX/CR | TOYO-15P | TPX2/TPX5/TPX6 | TPX2/TPX5/TPX6 | TP30 | 18 |
| | MARK 2 | 2000-2006 | TEX/- | TOYO-15P | TPX1/TPX6/TPX5 | TPX1/TPX6/TPX5 | TP07 | 18 |
| | MARK X | 2004- | TEX/CR | TOYO-15P | TPX2/TPX5/TPX6 | TPX2/TPX5/TPX6 | TP30 | 18 |
| | | 2004-2006 | TEX/CR | DEALER KEY | | | - | |
| | NOAH | 2004- | TEX/CR | TOYO-15P | TPX2/TPX5/TPX6 | TPX2/TPX5/TPX6 | TP30 | 18 |
| | OPEN DECK | 2000-2005 | TEX/CR | TOYO-15P | TPX2/TPX5/TPX6 | TPX2/TPX5/TPX6 | TP30 | 18 |
| | ORIGIN | 2000- | TEX/- | TOYO-30P | TPX1/TPX6/TPX5 | TPX1/TPX6/TPX5 | TP07 | 19 |
| | PLAZ | 1999-2002 | TEX/- | TOYO-20DP | TPX1/TPX6/TPX5 | TPX1/TPX6/TPX5 | TP07 | 19 |
| | | 2003-2005 | TEX/CR | TOYO-15P | TPX2/TPX5/TPX6 | TPX2/TPX5/TPX6 | TP30 | 18 |
| | PROGRESS NC300 | 1998-2006 | TEX/- | TOYO-30P | TPX1/TPX6/TPX5 | TPX1/TPX6/TPX5 | TP07 | 19 |
| | PRONARD | 2000-2002 | TEX/- | TOYO-15P | TPX1/TPX6/TPX5 | TPX1/TPX6/TPX5 | TP07 | 18 |
| | RAUM | 2003- | TEX/CR | TOYO-15P | TPX2/TPX5/TPX6 | TPX2/TPX5/TPX6 | TP30 | 18 |
| | RAV 4 | 2003-2010 | TEX/CR | TOYO-15P | TPX2/TPX5/TPX6 | TPX2/TPX5/TPX6 | TP30 | 18 |
| | REGIUSACE | 2007- | TEX/CR | TOYO-15P | TPX2/TPX5/TPX6 | TPX2/TPX5/TPX6 | TP30 | 18 |
| | SIENTA | 2003- | TEX/CR | TOYO-15P | TPX2/TPX5/TPX6 | TPX2/TPX5/TPX6 | TP30 | 18 |
| | TOYOACE | 2008- | TEX/CR | TOYO-15P | TPX2/TPX5/TPX6 | TPX2/TPX5/TPX6 | TP30 | 18 |
| | VANGUARD | 2005- | TEX/CR | TOYO-15P | TPX2/TPX5/TPX6 | TPX2/TPX5/TPX6 | TP30 | 18 |
| | VEROSSA | 2001-2004 | TEX/- | TOYO-15P | TPX1/TPX6/TPX5 | TPX1/TPX6/TPX5 | TP07 | 18 |
| | VITZ | 2003- | TEX/CR | TOYO-15P | TPX2/TPX5/TPX6 | TPX2/TPX5/TPX6 | TP30 | 18 |
| | VOXY | 2004- | TEX/CR | TOYO-15P | TPX2/TPX5/TPX6 | TPX2/TPX5/TPX6 | TP30 | 18 |
| | WINDOM | 2001-2004 | TEX/- | TOYO-30P | TPX1/TPX6/TPX5 | TPX1/TPX6/TPX5 | TP07 | 19 |
| | WISH | 2003- | TEX/CR | TOYO-15P | TPX2/TPX5/TPX6 | TPX2/TPX5/TPX6 | TP30 | 18 |
| TOYOTA® (SUDAFRIKA) | COROLLA | 2008- | TEX/CR | TOYO-19P | TPX2/TPX5/TPX6 | TPX2/TPX5/TPX6 | TP35 | 19 |
| | | 2008- | TEX/CR | ORIGINAL | | | - | |
| TOYOTA® (USA) | 4 RUNNER | 1999-2002 | TEX/- | TOYO-15P | TPX1/TPX6/TPX5 | TPX1/TPX6/TPX5 | TP07 | 18 |
| | | 2003-2010 | TEX/CR | TOYO-15P | TPX2/TPX5/TPX6 | TPX2/TPX5/TPX6 | TP30 | 18 |
| | | 2010- | TEX/CR | DEALER KEY | | | - | |
| | | 2011-2016 | TEX/DST80 | TOYO-15P | TPG1 | TPG1 | TP34 | 18 |
| | AVALON | 1998-2005 | TEX/- | TOYO-15P | TPX1/TPX6/TPX5 | TPX1/TPX6/TPX5 | TP07 | 18 |
| | | 2005-2011 | TEX/CR | TOYO-15P | TPX2/TPX5/TPX6 | TPX2/TPX5/TPX6 | TP30 | 18 |
| | | 2005-2012 | TEX/CR | DEALER KEY | | | - | |
| | | 2012-2012 | TEX/DST80 | TOYO-15P | TPG1 | TPG1 | TP34 | 18 |
| | | 2013-2018 | TEX/DST80 | DEALER KEY | | | - | |
| | C-HR | 2018- | TEX/AES | KI-7P | | TPAE1 | TP36 | 13 |
| | CAMRY | 1998-2006 | TEX/- | TOYO-15P | TPX1/TPX6/TPX5 | TPX1/TPX6/TPX5 | TP07 | 18 |
| | | 2003-2011 | TEX/CR | TOYO-15P | TPX2/TPX5/TPX6 | TPX2/TPX5/TPX6 | TP30 | 18 |
| | | 2006-2011 | TEX/CR | DEALER KEY | | | - | |
| | | 2012-2014 | TEX/DST80 | TOYO-15P | TPG1 | TPG1 | TP34 | 18 |
| | | 2012-2017 | TEX/DST80 | DEALER KEY | | | - | |
| | | 2015-2017 | TEX/AES | TOYO-15P | | TPAE1 | TP36 | 18 |
| | | 2018-2019 | TEX/AES | KI-7P | | TPAE1 | TP36 | 13 |

| FOR: |  |  |  |  | TRS-5000 EVO | EVO XPERT | Programming TP |  |
|-------------|---|---|---|---|-----------------|----------------|-------------------|---|
| COROLLA | 2005-2010 | TEX/CR | TOYO-15P | | TPX2/TPX5/TPX6 | TPX2/TPX5/TPX6 | TP30 | 18 |
| | 2009-2011 | TEX/CR | DEALER KEY | | | | - | |
| | 2010-2014 | TEX/DST80 | TOYO-15P | | TPG1 | TPG1 | TP34 | 18 |
| | 2014- | TEX/AES | DEALER KEY | | | | - | |
| | 2014- | TEX/AES | TOYO-15P | | | TPAE1 | TP36 | 18 |
| COROLLA IM | 2017- | TEX/AES | KI-7P | | | TPAE1 | TP36 | 13 |
| | 2017- | TEX/AES | DEALER KEY | | | | - | |
| FJ CRUISER | 2006-2010 | TEX/CR | TOYO-15P | | TPX2/TPX5/TPX6 | TPX2/TPX5/TPX6 | TP30 | 18 |
| | 2011-2015 | TEX/DST80 | TOYO-15P | | TPG1 | TPG1 | TP34 | 18 |
| HIACE | 2006-2013 | TEX/CR | TOYO-15P | | TPX2/TPX5/TPX6 | TPX2/TPX5/TPX6 | TP30 | 18 |
| HIGHLANDER | 2001-2003 | TEX/- | TOYO-15P | | TPX1/TPX6/TPX5 | TPX1/TPX6/TPX5 | TP07 | 18 |
| | 2004-2010 | TEX/CR | TOYO-15P | | TPX2/TPX5/TPX6 | TPX2/TPX5/TPX6 | TP30 | 18 |
| | 2008-2013 | TEX/CR | DEALER KEY | | | | - | |
| | 2011-2013 | TEX/DST80 | TOYO-15P | | TPG1 | TPG1 | TP34 | 18 |
| | 2014-2019 | TEX/AES | TOYO-15P | | | TPAE1 | TP36 | 18 |
| | 2014-2019 | TEX/AES | DEALER KEY | | | | - | |
| HILUX | 2004-2012 | TEX/CR | TOYO-15P | | TPX2/TPX5/TPX6 | TPX2/TPX5/TPX6 | TP30 | 19 |
| LANDCRUISER | 1998-2002 | TEX/- | TOYO-15P | | TPX1/TPX6/TPX5 | TPX1/TPX6/TPX5 | TP07 | 18 |
| | 2003-2008 | TEX/CR | TOYO-15P | | TPX2/TPX5/TPX6 | TPX2/TPX5/TPX6 | TP30 | 18 |
| | 2009-2018 | TEX/CR | DEALER KEY | | | | - | |
| MATRIX | 2005-2010 | TEX/CR | TOYO-15P | | TPX2/TPX5/TPX6 | TPX2/TPX5/TPX6 | TP30 | 18 |
| | 2011-2014 | TEX/DST80 | TOYO-15P | | TPG1 | TPG1 | TP34 | 18 |
| MR2 SPIDER | 2001-2005 | TEX/- | TOYO-20DP | | TPX1/TPX6/TPX5 | TPX1/TPX6/TPX5 | TP07 | 19 |
| PRIUS | 2001-2003 | TEX/- | TOYO-15P | | TPX1/TPX6/TPX5 | TPX1/TPX6/TPX5 | TP07 | 18 |
| | 2004-2008 | TEX/CR | TOYO-15P | | TPX2/TPX5/TPX6 | TPX2/TPX5/TPX6 | TP30 | 18 |
| | 2009-2011 | TEX/CR | DEALER KEY | | | | - | |
| PRIUS C | 2012-2014 | TEX/DST80 | TOYO-15P | | TPG1 | TPG1 | TP34 | 18 |
| | 2012-2018 | TEX/AES | DEALER KEY | | | | - | |
| | 2015-2018 | TEX/AES | TOYO-15P | | | TPAE1 | TP36 | 18 |
| RAV 4 | 2006-2010 | TEX/CR | TOYO-15P | | TPX2/TPX5/TPX6 | TPX2/TPX5/TPX6 | TP30 | 18 |
| | 2009-2010 | TEX/CR | DEALER KEY | | | | - | |
| | 2010-2012 | TEX/DST80 | TOYO-15P | | TPG1 | TPG1 | TP34 | 18 |
| | 2013-2018 | TEX/AES | TOYO-15P | | | TPAE1 | TP36 | 18 |
| | 2013-2018 | TEX/AES | DEALER KEY | | | | - | |
| SEQUOIA | 2001-2002 | TEX/- | TOYO-15P | | TPX1/TPX6/TPX5 | TPX1/TPX6/TPX5 | TP07 | 18 |
| | 2003-2010 | TEX/CR | TOYO-15P | | TPX2/TPX5/TPX6 | TPX2/TPX5/TPX6 | TP30 | 18 |
| | 2011-2014 | TEX/DST80 | TOYO-15P | | TPG1 | TPG1 | TP34 | 18 |
| | 2015- | TEX/AES | TOYO-15P | | | TPAE1 | TP36 | 18 |
| SIENNA VAN | 1999-2003 | TEX/- | TOYO-15P | | TPX1/TPX6/TPX5 | TPX1/TPX6/TPX5 | TP07 | 18 |
| | 2004-2010 | TEX/CR | TOYO-15P | | TPX2/TPX5/TPX6 | TPX2/TPX5/TPX6 | TP30 | 18 |
| | 2011-2014 | TEX/DST80 | TOYO-15P | | TPG1 | TPG1 | TP34 | 18 |
| | 2011-2018 | TEX/CR | DEALER KEY | | | | - | |
| | 2015- | TEX/AES | TOYO-15P | | | TPAE1 | TP36 | 18 |
| SOLARA | 1999-2003 | TEX/- | TOYO-15P | | TPX1/TPX6/TPX5 | TPX1/TPX6/TPX5 | TP07 | 18 |
| | 2004-2010 | TEX/CR | TOYO-15P | | TPX2/TPX5/TPX6 | TPX2/TPX5/TPX6 | TP30 | 18 |
| TACOMA | 2005-2010 | TEX/CR | TOYO-15P | | TPX2/TPX5/TPX6 | TPX2/TPX5/TPX6 | TP30 | 18 |
| | 2011-2015 | TEX/DST80 | TOYO-15P | | TPG1 | TPG1 | TP34 | 18 |
| | 2016-2019 | TEX/AES | TOYO-15P | | | TPAE1 | TP36 | 18 |
| TUNDRA | 2007-2010 | TEX/CR | TOYO-15P | | TPX2/TPX5/TPX6 | TPX2/TPX5/TPX6 | TP30 | 18 |
| | 2011-2018 | TEX/DST80 | TOYO-15P | | TPG1 | TPG1 | TP34 | 18 |

AUTOMÓVIL - CAMIONETA





CAR-PICK UP TRUCK





| FOR: |  |  |  |  | TRS-5000 EVO | EVO XPERT | Programming TP |  |
|-------------|---|---|---|---|-----------------|----------------|-------------------|---|
| | VENZA | 2016- | TEX/AES | TOYO-15P | | TPAE1 | TP36 | 18 |
| | | 2009-2010 | TEX/CR | TOYO-15P | TPX2/TPX5/TPX6 | TPX2/TPX5/TPX6 | TP30 | 18 |
| | | 2010-2014 | TEX/DST80 | TOYO-15P | TPG1 | TPG1 | TP34 | 18 |
| | | 2010-2015 | TEX/DST80 | DEALER KEY | | | - | |
| | YARIS | 2007-2011 | TEX/CR | TOYO-15P | TPX2/TPX5/TPX6 | TPX2/TPX5/TPX6 | TP30 | 18 |
| | | 2012-2014 | TEX/DST80 | TOYO-15P | TPG1 | TPG1 | TP34 | 18 |
| 2015-2018 | | TEX/AES | TOYO-15P | | TPAE1 | TP36 | 18 | |
| VOLKSWAGEN® | AMAROK | 2010-2016 | MEG/CR | HU-HAAP1 | TPX8+ | TPX8+ | TP23* | 7 |
| | BEETLE | 1998-2003 | MEG/CR | HU-HAATLV | TPX8+ | TPX8+ | TP08 | 8 |
| | | 1999-2003 | MEG/CR | HU-HAAP1 | TPX8+ | TPX8+ | TP08 | 7 |
| | | 2003-2011 | MEG/CR | HU-HAAP1 | TPX8+ | TPX8+ | TP23* | 7 |
| | | 2011-2016 | MEG/CR | HU-HAATLN | TPX8+ | TPX8+ | TP23* | 8 |
| | | 2014- | MEG/AES | ORIGINAL | | | - | |
| | | 2016- | MEG/AES | HU-5P | | | - | 7 |
| | BORA | 2016- | MEG/AES | HU-6P | | | - | 7 |
| | | 1998-2005 | MEG/CR | HU-HAAP1 | TPX8+ | TPX8+ | TP08 | 7 |
| | | 1998-2000 | MEG/CR | HU-HAATLV | TPX8+ | TPX8+ | TP08 | 8 |
| | CABRIO | 2001-2005 | MEG/CR | HU-HAATLN | TPX8+ | TPX8+ | TP08 | 8 |
| | | 2000-2005 | MEG/CR | HU-HAAP1 | TPH1 | TPH1 | TP14 | 7 |
| | | 2000-2005 | MEG/CR | HU-HAATLN | | | TP14 | 8 |
| | CADDY | 1995-1998 | PHI/- | VO-2P | TP01/TP05 | TP01/TP05 | TP01/TP05** | 10 |
| | | 1998-2000 | PHI/CR | VO-2P | TPH1 | TPH1 | TP10 | 10 |
| | | 2000-2003 | PHI/CR | VO-2P | TPH1 | TPH1 | TP14 | 10 |
| | | 2004- | MEG/CR | HU-HAAP1 | TPX8+ | TPX8+ | TP23* | 7 |
| | | 2004-2010 | MEG/CR | HU-HAATLN | TPX8+ | TPX8+ | TP23* | 8 |
| | CARAVELLE | 2003-2009 | MEG/CR | HU-HAAP1 | TPX8+ | TPX8+ | TP23* | 7 |
| | CRAFTER | 2006- | MEG/CR | ME-7P1 | TPX8+ | TPX8+ | TP23* | 8 |
| | CROSS GOLF | 2006-2012 | MEG/CR | HU-HAAP1 | TPX8+ | TPX8+ | TP23* | 7 |
| | DERBY | 2009- | MEG/CR | HU-HAAP1 | TPX8+ | TPX8+ | TP23* | 7 |
| | EOS | 2006-2015 | MEG/CR | HU-HAAP1 | TPX8+ | TPX8+ | TP23* | 7 |
| | EURO VAN | 2000-2004 | MEG/CR | HU-HAAP1 | TPX8+ | TPX8+ | TP08 | 7 |
| | FOX | 2005-2012 | MEG/CR | HU-HAAP1 | TPX8+ | TPX8+ | TP08 | 7 |
| | GOLF CABRIO | 1995-1998 | PHI/- | VO-2P | TP01/TP05 | TP01/TP05 | TP01/TP05** | 10 |
| | | 1998-2000 | PHI/- | HU-HAAP1 | TPH1 | TPH1 | TP10 | 7 |
| | | 2000-2004 | PHI/- | HU-HAAP1 | TPH1 | TPH1 | TP14 | 7 |
| | | 2004-2012 | MEG/CR | HU-HAAP1 | TPX8+ | TPX8+ | TP23* | 7 |
| | | 2012- | MEG/AES | ORIGINAL | | | - | |
| | GOLF GTI | 1998-2003 | MEG/CR | HU-HAATLN | TPX8+ | TPX8+ | TP08 | 8 |
| | GTI | 2000- | MEG/CR | HU-HAAP1 | TPX8+ | TPX8+ | TP08 | 7 |
| GOLF GTI | 2004-2007 | MEG/CR | HU-HAAP1 | TPX8+ | TPX8+ | TP23* | 7 | |
| | 2008-2012 | MEG/CR | HU-HAAP1 | TPX8+ | TPX8+ | TP23* | 7 | |
| | 2012- | MEG/AES | ORIGINAL | | | - | | |
| GOLF III | 1995-1998 | PHI/- | VO-2P | TP01/TP05 | TP01/TP05 | TP01/TP05** | 10 | |
| GOLF IV | 1998- | MEG/CR | HU-HAAP1 | TPX8+ | TPX8+ | TP08 | 7 | |
| | 1998-1999 | MEG/CR | HU-HAATLV | TPX8+ | TPX8+ | TP08 | 8 | |
| | 1998-2003 | MEG/CR | HU-HAATLN | TPX8+ | TPX8+ | TP08 | 8 | |
| GOLF V | 2004-2007 | MEG/CR | HU-HAAP1 | TPX8+ | TPX8+ | TP23* | 7 | |
| | 2004-2007 | MEG/CR | HU-HAATLN | TPX8+ | TPX8+ | TP23* | 8 | |
| GOLF VI | 2008-2012 | MEG/CR | HU-HAAP1 | TPX8+ | TPX8+ | TP23* | 7 | |
| GOLF VIII | 2020- | MEG/AES | ORIGINAL | | | - | | |

| FOR: |  |  |  |  | TRS-5000 EVO | EVO XPERT | Programming TP |  |
|------|---|---|---|---|-----------------|--------------|-------------------|---|
| | GOLF PLUS | 2005-2013 | MEG/CR | HU-HAAP1 | TPX8+ | TPX8+ | TP23* | 7 |
| | INDIVIDUAL | 2004-2008 | MEG/CR | HU-HAAP1 | TPX8+ | TPX8+ | TP23* | 7 |
| | JETTA | 2000-2004 | MEG/CR | HU-HAAP1 | TPX8+ | TPX8+ | TP08 | 7 |
| | | 2005-2012 | MEG/CR | HU-HAAP1 | TPX8+ | TPX8+ | TP23* | 7 |
| | | 2010-2016 | MEG/CR | HU-HAATLN | TPX8+ | TPX8+ | TP23* | 8 |
| | | 2012- | MEG/AES | ORIGINAL | | | - | |
| | | 2018- | MEG/AES | HU-5P | | | - | 7 |
| | | 2018- | MEG/AES | HU-6P | | | - | 7 |
| | KOMBI | 2003-2009 | MEG/CR | HU-HAAP1 | TPX8+ | TPX8+ | TP23* | 7 |
| | LAVIDA | 2008- | MEG/CR | HU-HAAP1 | TPX8+ | TPX8+ | TP08 | 7 |
| | LT 28 | 2000- | TEM/- | ME-HMP1 | TP05 | TP05 | TP05 | 21 |
| | LT 35 | 2000- | TEM/- | ME-HMP1 | TP05 | TP05 | TP05 | 21 |
| | LUPO | 1998-2000 | PHI/CR | HU-HAAP1 | TPH1 | TPH1 | TP10 | 7 |
| | | 2000-2005 | PHI/CR | HU-HAAP1 | TPH1 | TPH1 | TP14 | 7 |
| | MAGGIOLINO | 2011-2013 | MEG/CR | HU-HAAP1 | TPX8+ | TPX8+ | TP23* | 7 |
| | MAGOTAN | 2007- | MEG/CR | HU-HAAP1 | TPX8+ | TPX8+ | TP23* | 7 |
| | MULTIVAN | 2003-2009 | MEG/CR | HU-HAAP1 | TPX8+ | TPX8+ | TP23* | 7 |
| | NOUVELLE COCCINELLE | 2011-2013 | MEG/CR | HU-HAAP1 | TPX8+ | TPX8+ | TP23* | 7 |
| | PASSAT | 1995-1997 | PHI/- | VO-2P | TP01/TP05 | TP01/TP05 | TP01/TP05** | 10 |
| | | 1997-1998 | MEG/- | HU-HAAP1 | TP05 | TP05 | TP03/TP05** | 7 |
| | | 1998-1999 | MEG/CR | HU-HAATLV | TPX8+ | TPX8+ | TP08 | 8 |
| | | 1998-2004 | MEG/CR | HU-HAAP1 | TPX8+ | TPX8+ | TP08 | 7 |
| | | 2000-2005 | MEG/CR | HU-HAATLN | TPX8+ | TPX8+ | TP08 | 8 |
| | | 2004-2005 | MEG/CR | HU-HAAP1 | TPX8+ | TPX8+ | TP23* | 7 |
| | | 2005- | MEG/CR | DEALER KEY | | | - | |
| | PHAETON | 2002-2010 | PHI/CR2 | DEALER KEY | | | - | |
| | POLO | 1995-1998 | PHI/- | VO-2P | TP01/TP05 | TP01/TP05 | TP01/TP05** | 10 |
| | | 1998-2000 | PHI/CR | HU-HAAP1 | TPH1 | TPH1 | TP10 | 7 |
| | | 1998-2000 | PHI/CR | HU-HAATLV | TPH1 | TPH1 | TP10 | 8 |
| | | 2000-2002 | PHI/CR | HU-HAAP1 | TPH1 | TPH1 | TP14 | 7 |
| | | 2000-2002 | PHI/CR | HU-HAATLN | TPH1 | TPH1 | TP14 | 8 |
| | | 2002-2005 | MEG/CR | HU-HAAP1 | TPX8+ | TPX8+ | TP08 | 7 |
| | | 2002-2005 | MEG/CR | HU-HAATLN | TPX8+ | TPX8+ | TP08 | 8 |
| | | 2005-2014 | MEG/CR | HU-HAAP1 | TPX8+ | TPX8+ | TP23* | 7 |
| | | 2017- | MEG/AES | HU-5P | | | - | 7 |
| | | 2017- | MEG/AES | ORIGINAL | | | - | |
| | QUANTUM | 1997-1998 | PHI/- | HU-HAAP1 | TP01/TP05 | TP01/TP05 | TP01/TP05** | 7 |
| | | 1999- | MEG/CR | HU-HAAP1 | TPX8+ | TPX8+ | TP08 | 7 |
| | RABBIT | 2003-2008 | MEG/CR | HU-HAAP1 | TPX8+ | TPX8+ | TP23* | 7 |
| | ROUTAN | 2009-2015 | PHI/CR2 | CHR-15P1 | TPX4/TPX5 | TPX4/TPX5 | - | 1 |
| | | 2009- | PHI/CR2 | ORIGINAL | | | - | |
| | SAGITAR | 2011- | MEG/CR | HU-HAAP1 | TPX8+ | TPX8+ | TP08 | 7 |
| | SCIROCCO | 2008-2017 | MEG/CR | HU-HAAP1 | TPX8+ | TPX8+ | TP23* | 7 |
| | SHARAN | 1995-1998 | PHI/- | HU-HAAP1 | TP01/TP05 | TP01/TP05 | TP01/TP05** | 7 |
| | | 1995-1998 | PHI/- | HU-HAATLV | TP01/TP05 | TP01/TP05 | TP01/TP05** | 8 |
| | | 1998-2000 | PHI/CR | HU-HAAP1 | TPH1 | TPH1 | TP10 | 7 |
| | | 1998-2000 | PHI/CR | HU-HAATLV | TPH1 | TPH1 | TP10 | 8 |
| | | 2000-2004 | PHI/CR | HU-HAAP1 | TPH1 | TPH1 | TP14 | 7 |
| | | 2000-2004 | PHI/CR | HU-HAATLN | TPH1 | TPH1 | TP14 | 8 |
| | | 2005-2009 | MEG/CR | HU-HAAP1 | TPX8+ | TPX8+ | TP08 | 7 |

AUTOMÓVIL - CAMIONETA

CAR-PICK UP TRUCK

| FOR: |  |  |  |  | TRS-5000 EVO | EVO XPERT | Programming TP |  |
|----------------------------|---|---|---|---|-----------------|--------------|-------------------|---|
| | | 2010-2016 | MEG/CR | HU-HAAP1 | TPX8+ | TPX8+ | TP23* | 7 |
| | | 2016- | MEG/AES | ORIGINAL | | | - | |
| | SURAN | 2009-2013 | MEG/CR | HU-HAAP1 | TPX8+ | TPX8+ | TP23* | 7 |
| | TIGUAN | 2008-2016 | MEG/CR | HU-HAAP1 | TPX8+ | TPX8+ | TP23* | 7 |
| | | 2016- | MEG/AES | HU-5P | | | - | 7 |
| | | 2016- | MEG/AES | ORIGINAL | | | - | |
| | TOUAREG | 2003-2007 | PHI/CR2 | HU-HAAP1 | TPX4/TPX5 | TPX4/TPX5 | TP12 | 7 |
| | | 2008- | PHI/CR2 | DEALER KEY | | | - | |
| | TOURAN | 2003-2012 | MEG/CR | HU-HAAP1 | TPX8+ | TPX8+ | TP23* | 7 |
| | | 2013- | MEG/AES | HU-5P | | | - | 7 |
| | | 2013- | MEG/AES | ORIGINAL | | | - | |
| | TRANSPORTER | 1995-1998 | PHI/- | VO-2P | TP01/TP05 | TP01/TP05 | TP01/TP05** | 10 |
| | | 1998-2001 | PHI/CR | VO-2LP | TPH1 | TPH1 | TP10 | 10 |
| | | 1998-2001 | PHI/CR | VO-2P | TPH1 | TPH1 | TP10 | 10 |
| | | 1998-2001 | PHI/CR | VO-2P | TPH1 | TPH1 | TP14 | 10 |
| | | 2001-2004 | PHI/CR | HU-HAAP1 | TPH1 | TPH1 | TP14 | 7 |
| | | 2004-2014 | MEG/CR | HU-HAAP1 | TPX8+ | TPX8+ | TP23* | 7 |
| | | 2015- | MEG/AES | ORIGINAL | | | - | |
| | UPI | 2011-2016 | MEG/CR | HU-HAAP1 | TPX8+ | TPX8+ | TP23* | 7 |
| | VENTO | 1995-1998 | PHI/- | VO-2P | TP01/TP05 | TP01/TP05 | TP01/TP05** | 10 |
| 2010- | | MEG/CR | HU-HAAP1 | TPX8+ | TPX8+ | TP23* | 7 | |
| W8 | 2002- | MEG/CR | HU-HAAP1 | TPX8+ | TPX8+ | TP08 | 7 | |
| VOLKSWAGEN® (S.AMERICA) | BORA | 2008-2012 | MEG/CR | HU-HAAP1 | TPX8+ | TPX8+ | TP23* | 7 |
| | CROSS FOX | 2010- | MEG/CR | HU-HAAP1 | TPX8+ | TPX8+ | TP23* | 7 |
| | FOX | 2009- | MEG/CR | HU-HAAP1 | TPX8+ | TPX8+ | TP23* | 7 |
| | FOX SPORTVAN | 2006-2010 | MEG/CR | HU-HAAP1 | TPX8+ | TPX8+ | TP08 | 7 |
| | GOL | 1999-2004 | MEG/CR | VO-2DP | TPX8+ | TPX8+ | TP08 | 10 |
| | | 1999-2004 | MEG/CR | VO-8P | TPX8+ | TPX8+ | TP08 | 10 |
| | | 2005-2008 | MEG/CR | HU-HAAP1 | TPX8+ | TPX8+ | TP08 | 7 |
| | | 2009- | MEG/CR | HU-HAAP1 | TPX8+ | TPX8+ | TP23* | 7 |
| | GOLF | 1998-2004 | MEG/CR | HU-HAAP1 | TPX8+ | TPX8+ | TP08 | 7 |
| | KOMBI | 1999-2004 | MEG/CR | VO-2DP | TPX8+ | TPX8+ | TP08 | 10 |
| | | 1999-2004 | MEG/CR | VO-8P | TPX8+ | TPX8+ | TP08 | 10 |
| | PARATI | 1999-2004 | MEG/CR | VO-2DP | TPX8+ | TPX8+ | TP08 | 10 |
| | | 1999-2004 | MEG/CR | VO-8P | TPX8+ | TPX8+ | TP08 | 10 |
| | | 2005-2008 | MEG/CR | HU-HAAP1 | TPX8+ | TPX8+ | TP08 | 7 |
| | | 2009- | MEG/CR | HU-HAAP1 | TPX8+ | TPX8+ | TP23* | 7 |
| | SANTANA 2000 | 1998-2006 | MEG/CR | - | TPX8+ | TPX8+ | TP08 | |
| | | 1999- | MEG/CR | - | TPX8+ | TPX8+ | TP08 | |
| | SAVEIRO | 1999-2006 | MEG/CR | VO-2DP | TPX8+ | TPX8+ | TP08 | 10 |
| | | 1999-2006 | MEG/CR | VO-8P | TPX8+ | TPX8+ | TP08 | 10 |
| | | 2005-2008 | MEG/CR | HU-HAAP | TPX8+ | TPX8+ | TP08 | 7 |
| 2009- | | MEG/CR | HU-HAAP | TPX8+ | TPX8+ | TP23* | 7 | |
| SPACEFOX | 2006-2010 | MEG/CR | HU-HAAP1 | TPX8+ | TPX8+ | TP08 | 7 | |
| SPORTVAN | 2006-2010 | MEG/CR | HOND-31P | TPX8+ | TPX8+ | TP08 | 5 | |
| SURAN | 2006-2010 | MEG/CR | HU-HAAP1 | TPX8+ | TPX8+ | TP08 | 7 | |
| | 2009-2013 | MEG/CR | HU-HAAP1 | TPX8+ | TPX8+ | TP23* | 7 | |
| VOYAGE | 2009- | MEG/CR | HU-HAAP1 | TPX8+ | TPX8+ | TP23* | 7 | |

| FOR: |  |  |  |  | TRS-5000 EVO | EVO XPERT | Programming TP |  | |
|------------------------------|---|---|---|---|-----------------|--------------|-------------------|---|----|
| VOLKSWAGEN® (USA) | BEETLE | 2000-2005 | MEG/CR | HU-HAAP1 | TPX8+ | TPX8+ | TP08 | 7 | |
| | | 2006-2016 | MEG/CR | HU-HAAP1 | TPX8+ | TPX8+ | TP08 | 7 | |
| | | 2006-2016 | MEG/CR | HU-HAAP1 | TPX8+ | TPX8+ | TP23* | 7 | |
| | | 2018- | MEG/AES | DEALER KEY | | | - | | |
| | CABRIO | 2000-2004 | MEG/CR | DEALER KEY | | | - | | |
| | EOS | 2007-20015 | MEG/CR | HU-HAAP1 | TPX8+ | TPX8+ | TP08 | 7 | |
| | | 2007-20015 | MEG/CR | HU-HAAP1 | TPX8+ | TPX8+ | TP23* | 7 | |
| | EURO VAN | 2000-2002 | PHI/CR | HU-HAAP1 | TPH1 | TPH1 | TP14 | 7 | |
| | GLI | 2008-2011 | MEG/CR | HU-HAAP1 | TPX8+ | TPX8+ | TP23* | 7 | |
| | GOLF | 2000-2006 | MEG/CR | HU-HAAP1 | TPX8+ | TPX8+ | TP08 | 7 | |
| | | 2010-2016 | MEG/CR | HU-HAAP1 | TPX8+ | TPX8+ | TP08 | 15 | |
| | | 2010-2016 | MEG/CR | HU-HAAP1 | TPX8+ | TPX8+ | TP23* | 15 | |
| | GTI | 2000-2006 | MEG/CR | HU-HAAP1 | TPX8+ | TPX8+ | TP08 | 7 | |
| | | 2007-2016 | MEG/CR | HU-HAAP1 | TPX8+ | TPX8+ | TP08 | 7 | |
| | | 2007-2016 | MEG/CR | HU-HAAP1 | TPX8+ | TPX8+ | TP23* | 7 | |
| | JETTA | 2000-2005 | MEG/CR | HU-HAAP1 | TPX8+ | TPX8+ | TP08 | 7 | |
| | | 2006-2006 | MEG/CR | HU-HAAP1 | TPX8+ | TPX8+ | TP08 | 7 | |
| | | 2006-2006 | MEG/CR | HU-HAAP1 | TPX8+ | TPX8+ | TP23* | 7 | |
| | | 2007-2016 | MEG/CR | HU-HAAP1 | TPX8+ | TPX8+ | TP23* | 7 | |
| | | 2018- | MEG/AES | DEALER KEY | | | - | | |
| | PASSAT | 2001-2005 | MEG/CR | HU-HAAP1 | TPX8+ | TPX8+ | TP08 | 7 | |
| | | 2006-2008 | MEG/CR | HU-HAAP1 | TPX8+ | TPX8+ | TP08 | 7 | |
| | | 2006-2008 | MEG/CR | HU-HAAP1 | TPX8+ | TPX8+ | TP23* | 7 | |
| | PHAETON | 2004-2007 | MEG/CR | HU-HAAP1 | TPX8+ | TPX8+ | TP23* | 7 | |
| | | 2006-2008 | MEG/CR | DEALER KEY | | | - | | |
| | RABBIT | 2009-2011 | MEG/CR | HU-HAAP1 | TPX8+ | TPX8+ | TP08 | 7 | |
| | | 2009-2011 | MEG/CR | HU-HAAP1 | TPX8+ | TPX8+ | TP23* | 7 | |
| | ROUTAN | 2009-2015 | PHI/CR2 | CHR-15P1 | TPX4/TPX5 | TPX4/TPX5 | TP12CH | 1 | |
| VOLVO® | 850 | 1996-1997 | PHI/- | NE-40P1 | TP01/TP05 | TP01/TP05 | TP01/TP05** | 15 | |
| | 940 | 1996-1998 | PHI/- | NE-18P1 | TP01/TP05 | TP01/TP05 | TP01/TP05** | 14 | |
| | 960 | 1996-1998 | PHI/- | NE-40P1 | TP01/TP05 | TP01/TP05 | TP01/TP05** | 15 | |
| | | C70 | 1997-1998 | PHI/- | NE-40P1 | TP01/TP05 | TP01/TP05 | TP01/TP05** | 15 |
| | | | 1998-2004 | PHI/CR | ORIGINAL | | | - | |
| | POLAR | 2006-2013 | PHI/CR2 | DEALER KEY | | | - | | |
| | | 1996- | PHI/- | NE-18P1 | TP01/TP05 | TP01/TP05 | TP01/TP05** | 14 | |
| | | S40 | 1996-1998 | PHI/- | HU-DHP2 | TP01/TP05 | TP01/TP05 | TP01/TP05** | 7 |
| | 1998-2004 | | PHI/CR | ORIGINAL | | | - | | |
| | 2004-2012 | | MEG/CR | DEALER KEY | | | - | | |
| | S60 | 2000-2009 | MEG/CR | NE-40P1 | TPX8+ | TPX8+ | TP08 | 15 | |
| | | 2010-2018 | PHI/CR2 | DEALER KEY | | | - | | |
| | S70 | 1997-1998 | PHI/- | NE-40P1 | TP01/TP05 | TP01/TP05 | TP01/TP05** | 15 | |
| | | 1998-2000 | PHI/CR | ORIGINAL | | | TP14 | | |
| | S80 | 1998-1999 | PHI/CR | ORIGINAL | | | TP14 | | |
| | | 1998-2006 | MEG/CR | NE-40P1 | TPX8+ | TPX8+ | TP08 | 15 | |
| | | 1998-2006 | MEG/CR | ORIGINAL | | | - | | |
| | | 2006-2016 | PHI/CR2 | DEALER KEY | | | - | | |
| | S90 | 1997-1998 | PHI/- | NE-40P1 | TP01/TP05 | TP01/TP05 | TP01/TP05** | 15 | |
| | | 2016- | -/- | DEALER KEY | | | - | | |
| V40 | 1996-1998 | PHI/- | HU-DHP2 | TP01/TP05 | TP01/TP05 | TP01/TP05** | 7 | | |

AUTOMÓVIL - CAMIONETA

CAR-PICK UP TRUCK





| FOR: |  |  |  |  | TRS-5000 EVO | EVO XPERT | Programming TP |  | |
|-----------|---|---|---|---|-----------------|--------------|-------------------|---|----|
| V50 | 1998-2004 | PHI/CR | ORIGINAL | | | | - | | |
| | 2012- | PHI/CR2 | DEALER KEY | | | | - | | |
| | 2004-2013 | MEG/CR | DEALER KEY | | TPX8+ | TPX8+ | TP08 | | |
| | V60 | 2010-2018 | PHI/CR2 | DEALER KEY | | | - | | |
| | V70 | 1997-1998 | PHI/- | NE-40P1 | | TP01/TP05 | TP01/TP05 | TP01/TP05** | 15 |
| | | 1998-2000 | PHI/CR | ORIGINAL | | | | TP14 | |
| | | 2000-2007 | MEG/CR | NE-40P1 | | TPX8+ | TPX8+ | TP08 | 15 |
| | | 2000-2007 | MEG/CR | ORIGINAL | | | | - | |
| | V90 | 2007-2016 | PHI/CR2 | DEALER KEY | | | | - | |
| | | 1997-1998 | PHI/- | NE-40P1 | | TP01/TP05 | TP01/TP05 | TP01/TP05** | 15 |
| | | 2016- | -/- | DEALER KEY | | | | - | |
| | XC60 | 2009-2017 | PHI/CR2 | DEALER KEY | | | | - | |
| | XC 70 | 2001-2007 | MEG/CR | NE-40P1 | | TPX8+ | TPX8+ | TP08 | 15 |
| | | 2001-2007 | MEG/CR | ORIGINAL | | | | - | |
| | | 2008-2016 | PHI/CR2 | DEALER KEY | | | | - | |
| | XC 90 | 2003-2014 | MEG/CR | NE-40P1 | | TPX8+ | TPX8+ | TP08 | 15 |
| 2003-2014 | | MEG/CR | ORIGINAL | | TPX8+ | TPX8+ | TP08 | | |
| XC90 | 2015- | -/- | DEALER KEY | | | | - | | |
| VPG® | MV-1 | 2012-2014 | TEX/DST80 | FO-30DP | TPX7 | TPX7 | TP33 | 3 | |
| | | 2012-2014 | TEX/DST80 | ORIGINAL | | | - | | |

CAMIÓN

*KAMIOIA
TRUCKS
CAMION
LKW*







THE KEY TO EXCELLENCE
GLOBALLY UNLOCKING MILLIONS OF DOORS DAILY

| FOR: |  |  |  |  | TRS-5000 EVO | EVO XPERT | Programming TP |  |
|-------------------------|---|---|---|---|-----------------|----------------|-------------------|---|
| DAF [®] | CF | 2002-2012 | MEG/CR | NE-38P4 | TPX8+ | TPX8+ | TP08 | 15 |
| | | 2013- | MEG/CR | - | | | - | |
| | LF | 2002-2012 | MEG/CR | NE-38P4 | TPX8+ | TPX8+ | TP08 | 15 |
| | | 2013- | MEG/CR | - | | | - | |
| | XF | 2002-2012 | MEG/CR | NE-38P4 | TPX8+ | TPX8+ | TP08 | 15 |
| 2013- | | MEG/CR | - | - | | | | |
| XT | 2013- | MEG/CR | - | | | - | | |
| FORD [®] (USA) | HEAVY TRACK | 2000-2004 | TEX/CR | FO-15DCP | TPX1/TPX6/TPX5 | TPX1/TPX6/TPX5 | TP07 | 3 |
| ISUZU [®] | ELF | 2009- | PHI/CR2 | ISU-5P3 | TPX4/TPX5 | TPX4/TPX5 | TP12 | 12 |
| | F-SERIES | 2009- | PHI/CR2 | ISU-5P3 | TPX4/TPX5 | TPX4/TPX5 | TP12 | 12 |
| | FFR 500/600/700 | - | PHI/CR2 | ISU-5P3 | TPX4/TPX5 | TPX4/TPX5 | TP12 | 12 |
| | FRD 500 | - | PHI/CR2 | ISU-5P3 | TPX4/TPX5 | TPX4/TPX5 | TP12 | 12 |
| | FSD 700/850 | - | PHI/CR2 | ISU-5P3 | TPX4/TPX5 | TPX4/TPX5 | TP12 | 12 |
| | FSR 700/850 | - | PHI/CR2 | ISU-5P3 | TPX4/TPX5 | TPX4/TPX5 | TP12 | 12 |
| | FSS 550 | - | PHI/CR2 | ISU-5P3 | TPX4/TPX5 | TPX4/TPX5 | TP12 | 12 |
| | FTR 900 | - | PHI/CR2 | ISU-5P3 | TPX4/TPX5 | TPX4/TPX5 | TP12 | 12 |
| | FTS 800 | - | PHI/CR2 | ISU-5P3 | TPX4/TPX5 | TPX4/TPX5 | TP12 | 12 |
| | FVB | - | PHI/CR2 | ISU-5P3 | TPX4/TPX5 | TPX4/TPX5 | TP12 | 12 |
| | FVL 1400 | - | PHI/CR2 | ISU-5P3 | TPX4/TPX5 | TPX4/TPX5 | TP12 | 12 |
| | FVM 1400 | - | PHI/CR2 | ISU-5P3 | TPX4/TPX5 | TPX4/TPX5 | TP12 | 12 |
| | FVR 1000 | - | PHI/CR2 | ISU-5P3 | TPX4/TPX5 | TPX4/TPX5 | TP12 | 12 |
| | FVY 1400 | - | PHI/CR2 | ISU-5P3 | TPX4/TPX5 | TPX4/TPX5 | TP12 | 12 |
| | FVZ 1400 | - | PHI/CR2 | ISU-5P3 | TPX4/TPX5 | TPX4/TPX5 | TP12 | 12 |
| | N-SERIES | 2009- | PHI/CR2 | ISU-5P3 | TPX4/TPX5 | TPX4/TPX5 | TP12 | 12 |
| | NLR 200 | - | PHI/CR2 | ISU-5P3 | TPX4/TPX5 | TPX4/TPX5 | TP12 | 12 |
| | NLS 200 | - | PHI/CR2 | ISU-5P3 | TPX4/TPX5 | TPX4/TPX5 | TP12 | 12 |
| | NNR 200 | - | PHI/CR2 | ISU-5P3 | TPX4/TPX5 | TPX4/TPX5 | TP12 | 12 |
| | NPR 200/250/275/300 | - | PHI/CR2 | ISU-5P3 | TPX4/TPX5 | TPX4/TPX5 | TP12 | 12 |
| | NPS 250/300 | - | PHI/CR2 | ISU-5P3 | TPX4/TPX5 | TPX4/TPX5 | TP12 | 12 |
| NQR 450 | - | PHI/CR2 | ISU-5P3 | TPX4/TPX5 | TPX4/TPX5 | TP12 | 12 | |
| IVECO [®] | 35 C11 | 2000- | PHI/CR2 | FI-11P5 | TPX4/TPX5 | TPX4/TPX5 | TP12 | 19 |
| | | 2000- | PHI/CR2 | ORIGINAL | | | - | |
| | EUROCARGO | 2002-2007 | PHI/CR2 | FI-16P | TPX4/TPX5 | TPX4/TPX5 | TP12 | 20 |
| | | 2008- | TEX/DST80 | ORIGINAL | | | - | |
| | EUROSTAR | 1998-2002 | PHI/CR2 | FI-11P5 | TPX4/TPX5 | TPX4/TPX5 | TP12 | 19 |
| | S 2000 | 1998- | PHI/CR2 | FI-11P5 | TPX4/TPX5 | TPX4/TPX5 | TP12 | 19 |
| STRALIS | 2002-2007 | PHI/CR2 | FI-16P | TPX4/TPX5 | TPX4/TPX5 | TP12 | 20 | |
| | 2008- | TEX/DST80 | ORIGINAL | | | - | | |
| MAN [®] | TGA | 2003-2007 | MEG/- | HU-HCAP | TP05 | TP05 | TP03/TP05** | 8 |
| | TGL | 2005- | MEG/- | HU-HCAP | TP05 | TP05 | TP03/TP05** | 8 |
| | TGM | 2005- | MEG/- | HU-HCAP | TP05 | TP05 | TP03/TP05** | 8 |
| | TGS | 2007- | MEG/- | HU-HCAP | TP05 | TP05 | TP03/TP05** | 8 |
| | TGX | 2007- | MEG/- | HU-HCAP | TP05 | TP05 | TP03/TP05** | 8 |
| MERCEDES [®] | - | - | MEG/- | ME-9P1 | | | - | 8 |
| | ACTROS | 1997-2006 | MEG/- | ME-HMP1 | TP05 | TP05 | - | 21 |
| | | 1998-2006 | TEM/- | ME-HMP1 | TP05 | TP05 | - | 21 |
| | ATECO 815 | 1998- | MEG/- | ME-HMP1 | TP05 | TP05 | - | 21 |
| | | 1998- | TEM/- | ME-HMP1 | TP05 | TP05 | - | 21 |
| | SPRINTER | 1997-2006 | TEM/- | ME-HMP1 | TP05 | TP05 | - | 21 |

CAMIÓN

TRUCKS



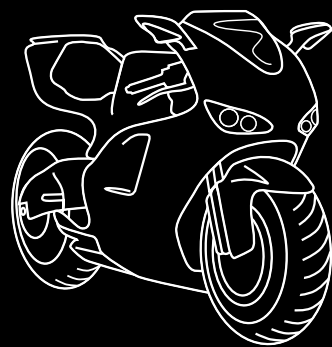

| FOR: |  |  |  |  | TRS-5000 EVO | EVO XPERT | Programming TP |  |
|-----------|---|---|---|---|-----------------|----------------|-------------------|---|
| NISSAN® | ATLEON | 2002-2006 | TEX/CR | DAT-6P2 | TPX2/TPX5/TPX6 | TPX2/TPX5/TPX6 | TP19 | 15 |
| | | 2002-2010 | TEX/CR | DAT-6P2 | TPX2/TPX5/TPX6 | TPX2/TPX5/TPX6 | TP19 | 15 |
| | | 2011-2013 | PHI/CR2 | DAT-6P2 | TPX4/TPX5 | TPX4/TPX5 | TP12NS | 15 |
| | | 2011-2013 | PHI/CR2 | ORIGINAL | | | - | |
| | CAB STAR | 2000-2003 | TEX/CR | DAT-6P2 | TPX2/TPX5/TPX6 | TPX2/TPX5/TPX6 | TP19 | 15 |
| | | 2003-2007 | TEX/CR | DAT-6P2 | TPX2/TPX5/TPX6 | TPX2/TPX5/TPX6 | - | 15 |
| | | 2007- | PHI/CR2 | DAT-15P2 | TPX4/TPX5 | TPX4/TPX5 | TP12NS | 15 |
| NT500 | 2007- | PHI/CR2 | ORIGINAL | | | - | | |
| | 2013- | PHI/CR2 | DAT15P2 | TPX4/TPX5 | TPX4/TPX5 | TP12NS | 3 | |
| RENAULT® | KERAX | 2002- | PHI/- | NE-38P4 | TP01/TP05 | TP01/TP05 | TP01/TP05** | 15 |
| | MAGNUM | 2004- | PHI/- | NE-38P4 | TP05 | TP05 | TP01/TP05** | 15 |
| | PREMIUM DXI | 2006- | PHI/CR2 | NE-38P4 | TPX4/TPX5 | TPX4/TPX5 | - | 15 |
| SCANIA® | 164 | 2004- | TEX/CR | HU-2P1 | TPX2/TPX5/TPX6 | TPX2/TPX5/TPX6 | TP19 | 7 |
| | | 2004- | TEX/CR | ORIGINAL | | | - | |
| | R-SERIES | 2005- | TEX/CR | HU-2P1 | TPX2/TPX5/TPX6 | TPX2/TPX5/TPX6 | TP19 | 7 |
| | | 2005- | TEX/CR | ORIGINAL | | | - | |
| STERLING® | BULLET | 2008-2009 | PHI/CR2 | CHR-15P | TPX4/TPX5 | TPX4/TPX5 | TP12CH | 1 |
| VOLVO® | SX 12 | 2007- | PHI/CR | HU-DHP3 | TPH1 | TPH1 | - | 7 |

MOTOCICLETA

MOTOZIKLETA
MOTORCYCLE
MOTOCYCLETTE
MOTORRAD













THE KEY TO EXCELLENCE
GLOBALLY UNLOCKING MILLIONS OF DOORS DAILY

| FOR: |  |  |  |  | TRS-5000 EVO | EVO XPERT | Programming TP |  |
|----------------------------------|---|---|---|---|-----------------|--------------|-------------------|---|
| APRILIA[®] | ATLANTIC 500 | 2001- | TEM/- | ZA-9P | TP05 | TP05 | - | 21 |
| | DORSODURO | 2008- | TEM/- | ZA-9P | TP05 | TP05 | - | 21 |
| | MANA 850 | 2007- | TEM/- | ZA-9P | TP05 | TP05 | - | 21 |
| | PEGASO | 2005-2007 | TEM/- | ZA-9P | TP05 | TP05 | - | 21 |
| | RSV 1000 | 2004-2008 | TEM/- | ZA-14P | TP05 | TP05 | - | 21 |
| | RSV SERIES | 2009- | TEM/- | ZA-14P | TP05 | TP05 | - | 21 |
| | SCARABEO 500 | 2001- | TEM/- | ZA-9P | TP05 | TP05 | - | 21 |
| | SHIVER | 2007- | TEM/- | ZA-9P | TP05 | TP05 | - | 21 |
| | SR 50 | 2004- | TEM/- | ZA-9P | TP05 | TP05 | - | 21 |
| | TUONO 1000R | 2004- | TEM/- | ZA-14P | TP05 | TP05 | - | 21 |
| APRILIA[®] (USA) | ATLANTIC 125 | 1996- | TEM/- | ZA-9P | TP05 | TP05 | - | 21 |
| | ATLANTIC 500 | 2003- | TEM/- | ZA-9P | TP05 | TP05 | - | 21 |
| | RS1000 | 2004- | TEM/- | ZA-14P | TP05 | TP05 | - | 21 |
| | SCARABEO 500 | 2003- | TEM/- | ZA-9P | TP05 | TP05 | - | 21 |
| | TUONO 1000R | 2004- | TEM/- | ZA-14P | TP05 | TP05 | - | 21 |
| BMW[®] | C 600 SPORT | 2012- | PHI/CR2 | BM-7P | TPX4/TPX5 | TPX4/TPX5 | - | 1 |
| | C 650 GT | 2012- | PHI/CR2 | BM-7P | TPX4/TPX5 | TPX4/TPX5 | - | 1 |
| | F 650 | 2008-2011 | PHI/CR2 | BM-7P | TPX4/TPX5 | TPX4/TPX5 | - | 1 |
| | F 800 | 2006- | PHI/CR2 | BM-7P | TPX4/TPX5 | TPX4/TPX5 | - | 1 |
| | G 650 | 2011- | PHI/CR2 | BM-7P | TPX4/TPX5 | TPX4/TPX5 | - | 1 |
| | K 1200 | 2005-2008 | PHI/CR2 | BM-7P | TPX4/TPX5 | TPX4/TPX5 | - | 1 |
| | K 1300 | 2009- | PHI/CR2 | BM-7P | TPX4/TPX5 | TPX4/TPX5 | - | 1 |
| | K 1600 | 2011- | PHI/CR2 | BM-7P | TPX4/TPX5 | TPX4/TPX5 | - | 1 |
| R 1200 RT | 2005- | PHI/CR2 | BM-7P | TPX4/TPX5 | TPX4/TPX5 | - | 1 | |
| DERBI[®] | BOULEVARD 150 | 2003- | TEM/- | FI-13P6 | TP05 | TP05 | - | 21 |
| DUCATI[®] | 1198 | 2007-2010 | TEM/- | DCT-1P | TP05 | TP05 | - | 3 |
| | 749 | 2002-2007 | TEM/- | DCT-1P | TP05 | TP05 | - | 3 |
| | 848 | 2008- | TEM/- | DCT-1P | TP05 | TP05 | - | 3 |
| | 999 | 2002-2006 | TEM/- | DCT-1P | TP05 | TP05 | - | 3 |
| | HYPERMOTARD | 2008- | TEM/- | DCT-1P | TP05 | TP05 | - | 3 |
| | MONSTER 600 | 2001- | TEM/- | DCT-1P | TP05 | TP05 | - | 3 |
| | MONSTER 600 S SPORT | 2001- | TEM/- | DCT-1P | TP05 | TP05 | - | 3 |
| | MONSTER 620 DARK | 2002-2006 | TEM/- | DCT-1P | TP05 | TP05 | - | 3 |
| | MONSTER 620 SPORT | 2003- | TEM/- | DCT-1P | TP05 | TP05 | - | 3 |
| | MONSTER 695 | 2001-2008 | TEM/- | DCT-1P | TP05 | TP05 | - | 3 |
| | MONSTER 696 | 2009- | TEM/- | ZA-14P | TP05 | TP05 | - | 21 |
| | MONSTER 750 | 2001-2002 | TEM/- | DCT-1P | TP05 | TP05 | - | 3 |
| | MONSTER 796 | 2011- | TEM/- | ZA-14P | TP05 | TP05 | - | 21 |
| | MONSTER 800 | 2003- | TEM/- | DCT-1P | TP05 | TP05 | - | 3 |
| | MONSTER 800 SPORT | 2003- | TEM/- | DCT-1P | TP05 | TP05 | - | 3 |
| | MONSTER 900 | 2001-2002 | TEM/- | DCT-1P | TP05 | TP05 | - | 3 |
| | MONSTER 999 R | 2003- | TEM/- | DCT-1P | TP05 | TP05 | - | 3 |
| | MONSTER 999 S | 2003- | TEM/- | DCT-1P | TP05 | TP05 | - | 3 |
| | MONSTER 1000 DS | 2003- | TEM/- | DCT-1P | TP05 | TP05 | - | 3 |
| | MONSTER 1000 | 2003-2006 | TEM/- | DCT-1P | TP05 | TP05 | - | 3 |
| | MONSTER 1100 | 2009- | TEM/- | ZA-14P | TP05 | TP05 | - | 21 |
| | MONSTER S2R | 2003-2008 | TEM/- | DCT-1P | TP05 | TP05 | - | 3 |
| | MONSTER S4 | 2001-2003 | TEM/- | DCT-1P | TP05 | TP05 | - | 3 |
| MONSTER S4R | 2004-2008 | TEM/- | DCT-1P | TP05 | TP05 | - | 3 | |

MOTOCICLETA





MOTORCYCLE





| FOR: |  |  |  |  | TRS-5000 EVO | EVO XPERT | Programming TP |  |
|-----------------|---|---|---|---|-----------------|--------------|-------------------|---|
| | MULTISTRADA | 2010- | TEX/CR/MA | ORIGINAL | | | - | |
| | SPORTCLASSIC 1000 | 2007-2010 | TEM/- | DCT-1P | TP05 | TP05 | - | 3 |
| | ST3 | 2005-2007 | TEM/- | DCT-1P | TP05 | TP05 | - | 3 |
| | ST4 | 2002-2005 | TEM/- | DCT-1P | TP05 | TP05 | - | 3 |
| | STREETFIGHTER | 2009- | TEM/- | ZA-14P | TP05 | TP05 | - | 21 |
| | SUPERSPORT 620 | 2003-2006 | TEM/- | DCT-1P | TP05 | TP05 | - | 3 |
| | SUPERSPORT 800 | 2003-2006 | TEM/- | DCT-1P | TP05 | TP05 | - | 3 |
| | SUPERSPORT 1000 | 2003-2006 | TEM/- | DCT-1P | TP05 | TP05 | - | 3 |
| GILERA® | FUOCO | 2006- | TEM/- | FI-16P | TP05 | TP05 | - | 20 |
| | GP 800 | 2006- | TEM/- | FI-16P | TP05 | TP05 | - | 20 |
| | NEXUS 250 | 2006-2008 | TEM/- | ZA-11P | TP05 | TP05 | - | 21 |
| | NEXUS 300 | 2007- | TEM/- | ZA-11P | TP05 | TP05 | - | 21 |
| | NEXUS 500 | 2006-2012 | TEM/- | FI-16P | TP05 | TP05 | - | 20 |
| HONDA® | AFRICAN TWIN | 2015- | PHI/CR2 | HOND-55P | TPX4/TPX5 | TPX4/TPX5 | TP12HN | 5 |
| | BLACK SPIRIT | 2010- | PHI/CR2 | HOND-24P1 | TPX4/TPX5 | TPX4/TPX5 | TP12HN | 4 |
| | CB 500 | 2016- | PHI/CR2 | HOND-55P | TPX4/TPX5 | TPX4/TPX5 | TP12HN | 5 |
| | CB 650 | 2014- | PHI/CR2 | HOND-55P | TPX4/TPX5 | TPX4/TPX5 | TP12HN | 5 |
| | CBF 600 | 2007-2012 | PHI/CR2 | HOND-55P | TPX4/TPX5 | TPX4/TPX5 | TP12HN | 5 |
| | CBR 650 | 2014- | PHI/CR2 | HOND-55P | TPX4/TPX5 | TPX4/TPX5 | TP12HN | 5 |
| | CBR 600F | 1999-2006 | PHI/CR2 | HOND-24P1 | TPX4/TPX5 | TPX4/TPX5 | TP12HN | 4 |
| | CBR 600RR | 2003-2016 | PHI/CR2 | HOND-24P1 | TPX4/TPX5 | TPX4/TPX5 | TP12HN | 4 |
| | CBR 900 | 2003- | PHI/CR2 | HOND-24P1 | TPX4/TPX5 | TPX4/TPX5 | TP12HN | 4 |
| | CBR 1000 | 2004-2013 | PHI/CR2 | HOND-24P1 | TPX4/TPX5 | TPX4/TPX5 | TP12HN | 4 |
| | | 2014- | PHI/CR2 | HOND-55P | TPX4/TPX5 | TPX4/TPX5 | TP12HN | 5 |
| | CBR 1100F | 1999- | PHI/CR2 | HOND-24P1 | TPX4/TPX5 | TPX4/TPX5 | TP12HN | 4 |
| | CBR 1100XX | 1999-2006 | PHI/CR2 | HOND-24P1 | TPX4/TPX5 | TPX4/TPX5 | TP12HN | 4 |
| | CROSSRUNNER | 2011-2014 | PHI/CR2 | HOND-24P1 | TPX4/TPX5 | TPX4/TPX5 | TP12HN | 4 |
| | | 2015- | PHI/CR2 | HOND-55P | TPX4/TPX5 | TPX4/TPX5 | TP12HN | 5 |
| | CROSSTOURER | 2012-2014 | PHI/CR2 | HOND-24P1 | TPX4/TPX5 | TPX4/TPX5 | TP12HN | 4 |
| | | 2015- | PHI/CR2 | HOND-55P | TPX4/TPX5 | TPX4/TPX5 | TP12HN | 5 |
| | CTX 700 | 2014- | PHI/CR2 | HOND-24P1 | TPX4/TPX5 | TPX4/TPX5 | TP12HN | 4 |
| | CTX1300 | 2014- | PHI/CR2 | HOND-24P1 | TPX4/TPX5 | TPX4/TPX5 | TP12HN | 4 |
| | GOLD WING | 2001-2010 | PHI/CR2 | HOND-21P | TPX4/TPX5 | TPX4/TPX5 | TP12HN | 4 |
| | | 2008-2013 | PHI/CR2 | HOND-54P1 | TPX4/TPX5 | TPX4/TPX5 | TP12HN | 12 |
| | HORNET | 2003-2013 | PHI/CR2 | HOND-24P1 | TPX4/TPX5 | TPX4/TPX5 | TP12HN | 4 |
| | INTEGRA | 2012-2015 | PHI/CR2 | HOND-24P1 | TPX4/TPX5 | TPX4/TPX5 | TP12HN | 4 |
| | | 2016- | PHI/CR2 | HOND-55P | TPX4/TPX5 | TPX4/TPX5 | TP12HN | 5 |
| | NC 700 S | 2012- | PHI/CR2 | HOND-24P1 | TPX4/TPX5 | TPX4/TPX5 | TP12HN | 4 |
| | NC 700 X | 2012- | PHI/CR2 | HOND-24P1 | TPX4/TPX5 | TPX4/TPX5 | TP12HN | 4 |
| | NC 750 | 2014- | PHI/CR2 | HOND-24P1 | TPX4/TPX5 | TPX4/TPX5 | TP12HN | 4 |
| | | 2014- | PHI/CR2 | HOND-55P | TPX4/TPX5 | TPX4/TPX5 | TP12HN | 5 |
| | NT 650V | 1999-2006 | PHI/CR2 | HOND-24P1 | TPX4/TPX5 | TPX4/TPX5 | TP12HN | 4 |
| | NT 700V | 2006-2012 | PHI/CR2 | HOND-24P1 | TPX4/TPX5 | TPX4/TPX5 | TP12HN | 4 |
| | NX 650V | 1999- | PHI/CR2 | HOND-24P1 | TPX4/TPX5 | TPX4/TPX5 | TP12HN | 4 |
| | RUNE | 2003- | PHI/CR2 | HOND-24P1 | TPX4/TPX5 | TPX4/TPX5 | TP12HN | 4 |
| SH 300 | 2007- | PHI/CR2 | ZA-11P | TPX4/TPX5 | TPX4/TPX5 | TP12HN | 21 | |
| SHADOW 750 | 2004- | PHI/CR2 | HOND-24P1 | TPX4/TPX5 | TPX4/TPX5 | TP12HN | 4 | |
| SILVER WING | 2001-2008 | PHI/CR2 | HOND-24P1 | TPX4/TPX5 | TPX4/TPX5 | TP12HN | 4 | |
| | 2008-2013 | PHI/CR2 | HOND-54P1 | TPX4/TPX5 | TPX4/TPX5 | TP12HN | 5 | |
| ST1300 PAN-EUR. | 2008- | PHI/CR2 | HOND-24P1 | TPX4/TPX5 | TPX4/TPX5 | TP12HN | 4 | |

| FOR: |  |  |  |  | TRS-5000 EVO | EVO XPERT | Programming TP |  |
|------------------|---|---|---|---|-----------------|----------------|-------------------|---|
| | SW-T400 | 2009- | PHI/CR2 | HOND-24P1 | TPX4/TPX5 | TPX4/TPX5 | TP12HN | 4 |
| | SW-T600 | 2011- | PHI/CR2 | HOND-24P1 | TPX4/TPX5 | TPX4/TPX5 | TP12HN | 4 |
| | TORNADO XR250 | 2017- | PHI/CR2 | HOND-56P | TPX4/TPX5 | TPX4/TPX5 | TP12HN | 5 |
| | VARADERO | 2003- | PHI/CR2 | HOND-24P1 | TPX4/TPX5 | TPX4/TPX5 | TP12HN | 4 |
| | | 2008- | PHI/CR2 | HOND-53P1 | TPX4/TPX5 | TPX4/TPX5 | TP12HN | 5 |
| | VFR 800 | 2006-2014 | PHI/CR2 | HOND-24P1 | TPX4/TPX5 | TPX4/TPX5 | TP12HN | 4 |
| | VFR1200 | 2009-2014 | PHI/CR2 | HOND-24P1 | TPX4/TPX5 | TPX4/TPX5 | TP12HN | 4 |
| | VT 750 C4 | 2004-2010 | PHI/CR2 | HOND-24P1 | TPX4/TPX5 | TPX4/TPX5 | TP12HN | 4 |
| | VT1300CX | 2009- | PHI/CR2 | HOND-24P1 | TPX4/TPX5 | TPX4/TPX5 | TP12HN | 4 |
| | VTX 1800C | 2002- | PHI/CR2 | HOND-24P1 | TPX4/TPX5 | TPX4/TPX5 | TP12HN | 4 |
| | X - ELEVEN | 2001-2003 | PHI/CR2 | HOND-24P1 | TPX4/TPX5 | TPX4/TPX5 | TP12HN | 4 |
| KAWASAKI® | ER-6 | 2012- | TEX/CR | KAW-16P1 | TPX2/TPX5/TPX6 | TPX2/TPX5/TPX6 | - | 12 |
| | | 2012- | TEX/CR | KAW-9P1 | TPX2/TPX5/TPX6 | TPX2/TPX5/TPX6 | - | 12 |
| | NINJA 650 | 2012- | TEX/CR | KAW-16P1 | TPX2/TPX5/TPX6 | TPX2/TPX5/TPX6 | - | 12 |
| | NINJA 1000 | 2011- | TEX/CR | KAW-16P1 | TPX2/TPX5/TPX6 | TPX2/TPX5/TPX6 | - | 12 |
| | | 2011- | TEX/CR | ORIGINAL | - | - | - | - |
| | NINJA ZX-6R | 2006- | TEX/CR | KAW-9P1 | TPX2/TPX5/TPX6 | TPX2/TPX5/TPX6 | - | 12 |
| | | 2006- | TEX/CR | ORIGINAL | - | - | - | - |
| | NINJA ZX-10R | 2004-2010 | TEX/CR | KAW-9P1 | TPX2/TPX5/TPX6 | TPX2/TPX5/TPX6 | - | 12 |
| | | 2004-2010 | TEX/CR | ORIGINAL | - | - | - | - |
| | | 2011- | TEX/CR | KAW-16P1 | TPX2/TPX5/TPX6 | TPX2/TPX5/TPX6 | - | 12 |
| | | 2011- | TEX/CR | ORIGINAL | - | - | - | - |
| | NINJA ZX-12R | 2002-2006 | TEX/CR | KAW-9P1 | TPX2/TPX5/TPX6 | TPX2/TPX5/TPX6 | - | 12 |
| | NINJA ZX-14R | 2006-2011 | TEX/CR | KAW-9P1 | TPX2/TPX5/TPX6 | TPX2/TPX5/TPX6 | - | 12 |
| | | 2012- | TEX/CR | KAW-16P1 | TPX2/TPX5/TPX6 | TPX2/TPX5/TPX6 | - | 12 |
| | | 2012- | TEX/CR | ORIGINAL | - | - | - | - |
| | Z 750S | 2006- | TEX/CR | KAW-9P1 | TPX2/TPX5/TPX6 | TPX2/TPX5/TPX6 | - | 12 |
| | | 2006- | TEX/CR | ORIGINAL | - | - | - | - |
| | Z 1000 | 2004-2009 | TEX/CR | KAW-9P1 | TPX2/TPX5/TPX6 | TPX2/TPX5/TPX6 | - | 12 |
| | | 2004-2009 | TEX/CR | ORIGINAL | - | - | - | - |
| | | 2010- | TEX/CR | KAW-16P1 | TPX2/TPX5/TPX6 | TPX2/TPX5/TPX6 | - | 12 |
| | 2010- | TEX/CR | ORIGINAL | - | - | - | - | |
| ZZR 1200 | 2002-2006 | TEX/CR | KAW-9P1 | TPX2/TPX5/TPX6 | TPX2/TPX5/TPX6 | - | 12 | |
| ZZR 1400 | 2007-2011 | TEX/CR | KAW-9P1 | TPX2/TPX5/TPX6 | TPX2/TPX5/TPX6 | - | 12 | |
| | 2007-2011 | TEX/CR | ORIGINAL | - | - | - | - | |
| | 2012- | TEX/CR | KAW-16P1 | TPX2/TPX5/TPX6 | TPX2/TPX5/TPX6 | - | 12 | |
| | 2012- | TEX/CR | ORIGINAL | - | - | - | - | |
| MALAGUTI® | FIREFOX F15 | 1996- | TEM/- | ZA-9P | TP05 | TP05 | - | 21 |
| MBK® | BOOSTER | 1997-2004 | TEM/- | ZA-9P | TP05 | TP05 | - | 21 |
| | | 1999-2004 | TEM/- | ZA-11P | TP05 | TP05 | - | 21 |
| | CT 50 | 1995- | TEM/- | ZA-9P | TP05 | TP05 | - | 21 |
| | DOODO | 1995- | TEM/- | ZA-9P | TP05 | TP05 | - | 21 |
| | FIZZ | 1995- | TEM/- | ZA-9P | TP05 | TP05 | - | 21 |
| | FLIPPER | 1995- | TEM/- | ZA-9P | TP05 | TP05 | - | 21 |
| | NEW FLAME | 1995- | TEM/- | ZA-9P | TP05 | TP05 | - | 21 |
| | NEW SORRISO | 1995- | TEM/- | ZA-9P | TP05 | TP05 | - | 21 |
| | NITRO | 1995- | TEM/- | ZA-9P | TP05 | TP05 | - | 21 |
| | OVETTO | 1998-2004 | TEM/- | ZA-9P | TP05 | TP05 | - | 21 |
| | SKYLINER | 1995- | TEM/- | ZA-9P | TP05 | TP05 | - | 21 |
| | STUNT CAT | 1995- | TEM/- | ZA-9P | TP05 | TP05 | - | 21 |

MOTOCICLETA





MOTORCYCLE

| FOR: |  |  |  |  | TRS-5000 EVO | EVO XPERT | Programming TP |  |
|------------------|---|---|---|---|-----------------|--------------|-------------------|---|
| | TARGET | 1995- | TEM/- | ZA-9P | TP05 | TP05 | - | 21 |
| | THUNDER | 1995- | TEM/- | ZA-9P | TP05 | TP05 | - | 21 |
| | XC 125 | 1995- | TEM/- | ZA-9P | TP05 | TP05 | - | 21 |
| | XC 150 | 1995- | TEM/- | ZA-9P | TP05 | TP05 | - | 21 |
| MOTO GUZZI® | BELLAGIO | 2006- | TEM/- | ZA-14P | TP05 | TP05 | - | 20 |
| | GRISO | 2006- | TEM/- | ZA-14P | TP05 | TP05 | - | 21 |
| | NORGE | 2006- | TEM/- | ZA-14P | TP05 | TP05 | - | 21 |
| | STELVIO | 2007- | TEM/- | ZA-14P | TP05 | TP05 | - | 21 |
| PEUGEOT® | ALISE | 1998- | PHI/- | NE-45P1 | TP05 | TP05 | - | 15 |
| | | 1998- | TEM/- | NE-45P1 | TP05 | TP05 | - | 15 |
| | ELISEO | 1998-2003 | PHI/- | NE-45P1 | TP05 | TP05 | - | 15 |
| | | 1998-2003 | TEM/- | NE-45P1 | TP05 | TP05 | - | 15 |
| | ELYSTAR | 2002-2006 | PHI/- | NE-45P1 | TP05 | TP05 | - | 15 |
| | | 2002-2006 | TEM/- | NE-45P1 | TP05 | TP05 | - | 15 |
| | GEOPOLIS | 2006- | PHI/- | NE-45P1 | TP05 | TP05 | - | 15 |
| | | 2006- | TEM/- | NE-45P1 | TP05 | TP05 | - | 15 |
| | JET FORCE | 2003-2006 | PHI/- | NE-45P1 | TP05 | TP05 | - | 15 |
| | | 2003-2006 | TEM/- | NE-45P1 | TP05 | TP05 | - | 15 |
| | LOOXOR | 2001-2006 | PHI/- | NE-45P1 | TP05 | TP05 | - | 15 |
| | | 2001-2006 | TEM/- | NE-45P1 | TP05 | TP05 | - | 15 |
| | SPEEDFIGHT | 1997- | PHI/- | NE-45P1 | TP05 | TP05 | - | 15 |
| | | 1997- | TEM/- | NE-45P1 | TP05 | TP05 | - | 15 |
| | SV | 1996- | PHI/- | NE-45P1 | TP05 | TP05 | - | 15 |
| | | 1996- | TEM/- | NE-45P1 | TP05 | TP05 | - | 15 |
| VIVACITY | 1999- | PHI/- | NE-45P1 | TP05 | TP05 | - | 15 | |
| | 1999- | TEM/- | NE-45P1 | TP05 | TP05 | - | 15 | |
| X-FIGHT | 2001- | PHI/- | NE-45P1 | TP05 | TP05 | - | 15 | |
| | 2001- | TEM/- | NE-45P1 | TP05 | TP05 | - | 15 | |
| PIAGGIO® | BEVERLY | 2002-2011 | TEM/- | FI-13P6 | TP05 | | - | 21 |
| | | 2010- | TEM/- | FI-16P | TP05 | | - | 20 |
| | BEVERLY 200 | 2003- | TEM/- | FI-13P6 | TP05 | | - | 21 |
| | BEVERLY 250 | 2005- | TEM/- | FI-13P6 | TP05 | | - | 21 |
| | BEVERLY 500 | 2005- | TEM/- | FI-13P6 | TP05 | | - | 21 |
| | CARNABY | 2009- | TEM/- | FI-13P6 | TP05 | | - | 21 |
| | FLY | 2009-2012 | TEM/- | FI-13P6 | TP05 | | - | 21 |
| | | 2012- | TEM/- | ORIGINAL | | | - | |
| | HEXAGON | 1998-2003 | TEM/- | FI-13P6 | TP05 | | - | 21 |
| | LIBERTY | 2003- | TEM/- | FI-13P6 | TP05 | | - | 21 |
| | MP3 | 2006- | TEM/- | FI-16P | TP05 | | - | 20 |
| | SKIPPER | 2000-2002 | TEM/- | FI-13P6 | TP05 | | - | 21 |
| | VESPA | 1996- | TEM/- | FI-13P6 | TP05 | | - | 21 |
| | X7 | 2007-2009 | TEM/- | FI-13P6 | TP05 | | - | 21 |
| | | 2010- | TEM/- | FI-16P | TP05 | | - | 20 |
| | X8 | 2004- | TEM/- | FI-13P6 | TP05 | | - | 21 |
| | | 2006- | TEM/- | FI-16P | TP05 | | - | 20 |
| X9 500 | 1998-2007 | TEM/- | FI-13P6 | TP05 | | - | 21 | |
| X9 EVOLUTION 500 | 1998-2007 | TEM/- | FI-13P6 | TP05 | | - | 21 | |
| X10 | 2012- | TEM/- | FI-16P | TP05 | | - | 20 | |
| XEVO 400 | 2006-2013 | TEM/- | FI-16P | TP05 | | - | 20 | |

| FOR: |  |  |  |  | TRS-5000 EVO | EVO XPERT | Programming TP |  |
|-----------|---|---|---|---|-----------------|----------------|-------------------|---|
| SUZUKI® | BURGMAN 150 | 2004- | TEX/- | ORIGINAL | | | - | |
| | BURGMAN 400 | 2004- | TEX/- | ORIGINAL | | | - | |
| | BURGMAN 650 | 2004- | TEX/- | ORIGINAL | | | - | |
| | GSF BANDIT | 2007- | TEX/CR | SUZU-15DP | TPX2/TPX5/TPX6 | TPX2/TPX5/TPX6 | - | 17 |
| | | 2007- | TEX/CR | ORIGINAL | | | - | |
| | GSR 600 | 2007- | TEX/CR | SUZU-15DP | TPX2/TPX5/TPX6 | TPX2/TPX5/TPX6 | - | 17 |
| | | 2007- | TEX/CR | ORIGINAL | | | - | |
| | GSX 1300 HAYABUSA | 2007- | TEX/CR | SUZU-15DP | TPX2/TPX5/TPX6 | TPX2/TPX5/TPX6 | - | 17 |
| | | 2007- | TEX/CR | ORIGINAL | | | - | |
| | GSX-R600 | 2006- | TEX/CR | SUZU-15DP | TPX2/TPX5/TPX6 | TPX2/TPX5/TPX6 | - | 17 |
| | | 2006- | TEX/CR | ORIGINAL | | | - | |
| | GSX-R750 | 2006- | TEX/CR | SUZU-15DP | TPX2/TPX5/TPX6 | TPX2/TPX5/TPX6 | - | 17 |
| 2006- | | TEX/CR | ORIGINAL | | | - | | |
| GSX-R1000 | 2006- | TEX/CR | SUZU-15DP | TPX2/TPX5/TPX6 | TPX2/TPX5/TPX6 | - | 17 | |
| | 2006- | TEX/CR | ORIGINAL | | | - | | |
| V-STROM | 2007- | TEX/CR | SUZU-15DP | TPX2/TPX5/TPX6 | TPX2/TPX5/TPX6 | - | 17 | |
| | 2007- | TEX/CR | ORIGINAL | | | - | | |
| TRIUMPH® | TIGER | 2010- | PHI/CR2 | ZA-11P | TPX4/TPX5 | TPX4/TPX5 | - | 21 |
| VESPA® | ET4 | 1996- | TEM/- | FI-13P6 | TP05 | TP05 | - | 21 |
| | GRANTURISMO 200 | 1996- | TEM/- | FI-13P6 | TP05 | TP05 | - | 21 |
| | GT 200 | 1996- | TEM/- | FI-13P6 | TP05 | TP05 | - | 21 |
| | GT60 250 | 1996- | TEM/- | FI-13P6 | TP05 | TP05 | - | 21 |
| | GTS 200 | 1996- | TEM/- | FI-13P6 | TP05 | TP05 | - | 21 |
| | GTS 250 | 1996- | TEM/- | FI-13P6 | TP05 | TP05 | - | 21 |
| | GTV 250 | 1996- | TEM/- | FI-13P6 | TP05 | TP05 | - | 21 |
| | LX 125 | 1996- | TEM/- | FI-13P6 | TP05 | TP05 | - | 21 |
| LXV 150 | 1996- | TEM/- | FI-13P6 | TP05 | TP05 | - | 21 | |
| YAMAHA® | AEROX | 1998-2007 | MEG/- | ZA-11P | TP05 | TP05 | TP03/TP05** | 21 |
| | BT 1100 BULLDOG | 2005-2007 | TEX/CR | YAMA-26DP2 | TPX2/TPX6 | TPX2/TPX6 | - | 21 |
| | FJ-09 | 2015- | TEX/CR | YAMA-26DP2 | TPX2/TPX5/TPX6 | TPX2/TPX5/TPX6 | TP31 | 21 |
| | FJR 1300 | 2005-2015 | TEX/CR | YAMA-26DP2 | TPX2/TPX5/TPX6 | TPX2/TPX5/TPX6 | TP31 | 21 |
| | FZ1 | 2006- | TEX/CR | YAMA-26DP2 | TPX2/TPX5/TPX6 | TPX2/TPX5/TPX6 | TP31 | 21 |
| | FZ6 | 2004-2011 | TEX/CR | YAMA-26DP2 | TPX2/TPX5/TPX6 | TPX2/TPX5/TPX6 | TP31 | 21 |
| | FZ-07 | 2013- | TEX/CR | YAMA-26DP2 | TPX2/TPX5/TPX6 | TPX2/TPX5/TPX6 | TP31 | 21 |
| | FZ8 | 2010- | TEX/CR | YAMA-26DP2 | TPX2/TPX5/TPX6 | TPX2/TPX5/TPX6 | TP31 | 21 |
| | FZ-09 | 2013- | TEX/CR | YAMA-26DP2 | TPX2/TPX5/TPX6 | TPX2/TPX5/TPX6 | TP31 | 21 |
| | FZS 1000 FAZER | 2005- | TEX/CR | YAMA-26DP2 | TPX2/TPX5/TPX6 | TPX2/TPX5/TPX6 | TP31 | 21 |
| | MAJESTY 400 | 2005- | TEX/CR | YAMA-26DP2 | TPX2/TPX5/TPX6 | TPX2/TPX5/TPX6 | TP31 | 21 |
| | MT-01 | 2005-2012 | TEX/CR | YAMA-26DP2 | TPX2/TPX5/TPX6 | TPX2/TPX5/TPX6 | TP31 | 21 |
| | MT-03 | 2006-2013 | TEX/CR | YAMA-26DP2 | TPX2/TPX5/TPX6 | TPX2/TPX5/TPX6 | TP31 | 21 |
| | MT-07 | 2013- | TEX/CR | YAMA-26DP2 | TPX2/TPX5/TPX6 | TPX2/TPX5/TPX6 | TP31 | 21 |
| | MT-09 | 2013- | TEX/CR | YAMA-26DP2 | TPX2/TPX5/TPX6 | TPX2/TPX5/TPX6 | TP31 | 21 |
| | MT-09 TRACER | 2015- | TEX/CR | YAMA-26DP2 | TPX2/TPX5/TPX6 | TPX2/TPX5/TPX6 | TP31 | 21 |
| | NEOS | 1998- | MEG/- | ZA-11P | TP05 | TP05 | TP03/TP05** | 21 |
| | T-MAX 500 | 2005-2014 | TEX/CR | YAMA-26DP2 | TPX2/TPX5/TPX6 | TPX2/TPX5/TPX6 | TP31 | 21 |
| | TDM 600 | 2005- | TEX/CR | YAMA-26DP2 | TPX2/TPX5/TPX6 | TPX2/TPX5/TPX6 | TP31 | 21 |
| | TDM 900 | 2004- | TEX/CR | YAMA-26DP2 | TPX2/TPX5/TPX6 | TPX2/TPX5/TPX6 | TP31 | 21 |
| | XJR 1300 | 2004- | TEX/CR | YAMA-26DP2 | TPX2/TPX5/TPX6 | TPX2/TPX5/TPX6 | TP31 | 21 |
| | X-MAX 125 | 2006- | TEX/CR | ZA-11P | TPX2/TPX5/TPX6 | TPX2/TPX5/TPX6 | TP31 | 21 |
| | | 2006- | TEX/CR | ZA-9P | TPX2/TPX5/TPX6 | TPX2/TPX5/TPX6 | TP31 | 21 |

MOTOCICLETA

MOTORCYCLE

| FOR: |  |  |  |  | TRS-5000 EVO | EVO XPERT | Programming TP |  |
|---------------------|---|---|---|---|-----------------|----------------|-------------------|---|
| X-MAX 250 | | 2006-2017 | MEG/- | ZA-11P | TP05 | TP05 | TP03/TP05** | 21 |
| | | 2006-2017 | MEG/- | ZA-9P | TP05 | TP05 | TP03/TP05** | 21 |
| | | 2006-2017 | TEM/- | ZA-11P | TP05 | TP05 | TP05 | 21 |
| | | 2006-2017 | TEM/- | ZA-9P | TP05 | TP05 | TP05 | 21 |
| | | 2006-2017 | TEX/CR | YAMA-26DP2 | TPX2/TPX5/TPX6 | TPX2/TPX5/TPX6 | TP31 | 21 |
| X-MAX 300 | | 2017- | TEX/CR | ORIGINAL | | - | | |
| X-MAX 400 | | 2015- | TEX/CR | ORIGINAL | | - | | |
| XP 500 | | 2004- | TEX/CR | YAMA-26DP2 | TPX2/TPX5/TPX6 | TPX2/TPX5/TPX6 | TP31 | 21 |
| XT 660R | | 2004- | TEX/CR | YAMA-26DP2 | TPX2/TPX5/TPX6 | TPX2/TPX5/TPX6 | TP31 | 21 |
| XT 660Z TENERE | | 2008- | TEX/CR | YAMA-26DP2 | TPX2/TPX5/TPX6 | TPX2/TPX5/TPX6 | TP31 | 21 |
| XT 1200Z S.TENERE | | 2010- | TEX/CR | YAMA-26DP2 | TPX2/TPX5/TPX6 | TPX2/TPX5/TPX6 | TP31 | 21 |
| XTR | | 2004- | TEX/CR | YAMA-26DP2 | TPX2/TPX5/TPX6 | TPX2/TPX5/TPX6 | TP31 | 21 |
| XTX | | 2004- | TEX/CR | YAMA-26DP2 | TPX2/TPX5/TPX6 | TPX2/TPX5/TPX6 | TP31 | 21 |
| XVS 650A DRAG STAR | | 2004- | TEX/CR | YAMA-26DP2 | TPX2/TPX5/TPX6 | TPX2/TPX5/TPX6 | TP31 | 21 |
| XVS 1100A DRAG STAR | | 2004- | TEX/CR | YAMA-26DP2 | TPX2/TPX5/TPX6 | TPX2/TPX5/TPX6 | TP31 | 21 |
| YP 400 | | 2004- | TEX/CR | YAMA-26DP2 | TPX2/TPX5/TPX6 | TPX2/TPX5/TPX6 | TP31 | 21 |
| YVS A DRAG STAR | | 2003- | TEX/CR | YAMA-26DP2 | TPX2/TPX5/TPX6 | TPX2/TPX5/TPX6 | TP31 | 21 |
| YZF R1 | | 2005- | TEX/CR | YAMA-26DP2 | TPX2/TPX5/TPX6 | TPX2/TPX5/TPX6 | TP31 | 21 |
| YZF R6 | | 2003- | TEX/CR | YAMA-26DP2 | TPX2/TPX5/TPX6 | TPX2/TPX5/TPX6 | TP31 | 21 |
| ZTR | | 2004- | TEX/CR | YAMA-26DP2 | TPX2/TPX5/TPX6 | TPX2/TPX5/TPX6 | TP31 | 21 |

TIPOS DE LLAVES

GILTZA MOTAK
TYPES OF KEYS
TYPES DE CLÉS
SCHLÜSSELTYP



THE KEY TO EXCELLENCE
GLOBALLY UNLOCKING MILLIONS OF DOORS DAILY

FOR: BMW®

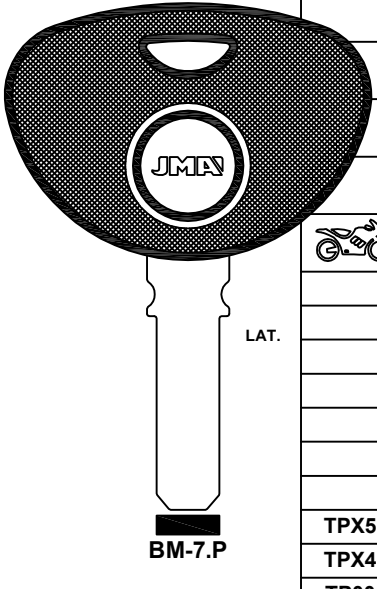





LAT.

BM-7.P

TPX5
TPX4
TP00

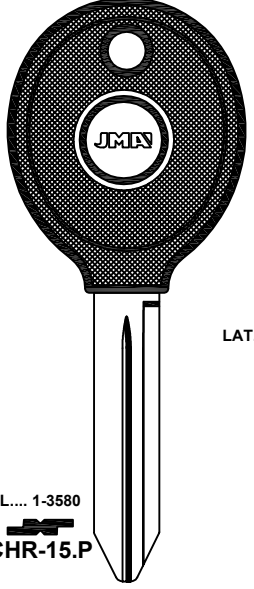
FOR: CHRYSLER®





LAT.

L.... 1-3580

CHR-15.P

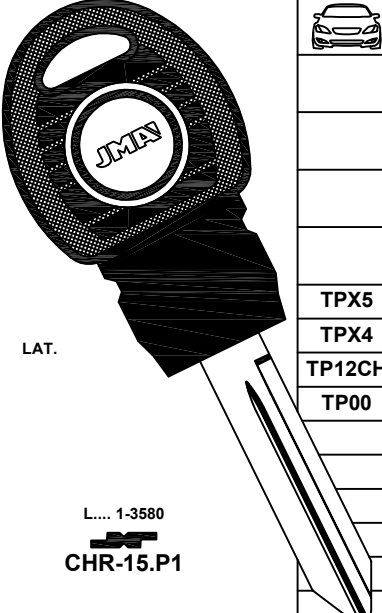
TPX6
TPX5
TPX4
TPX2
TP21
TP19
TP12MT
TP12CH
TP00



LAT.

L.... 1-3580

CHR-15.P1

TPX5
TPX4
TP12CH
TP00

FOR:
 BMW®
 CHRYSLER®
 DACIA®
 DAEWOO®

FOR: CHRYSLER®

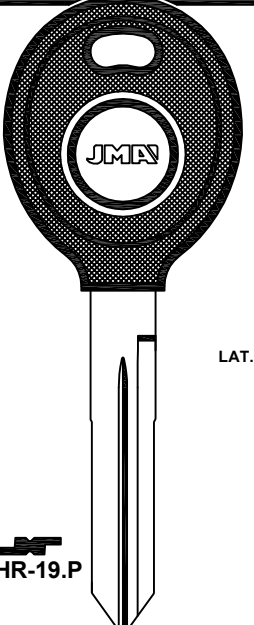



LAT.

CHR-19.P

TPX6
TPX5
TPX2
TP26
TP00

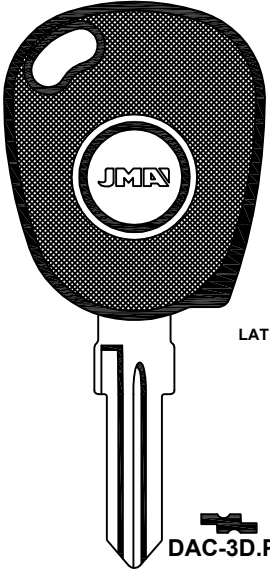
FOR: DACIA®

LAT.

DAC-3D.P4

TP05
TP00

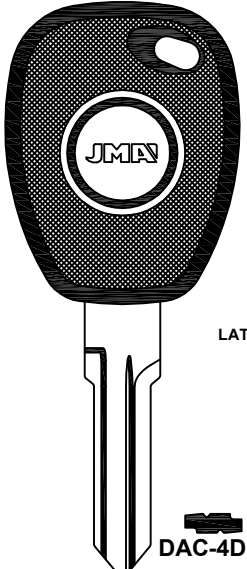

LAT.

DAC-4D.P

TPX5
TPX4
TP12RN
TP00

FOR: DACIA®

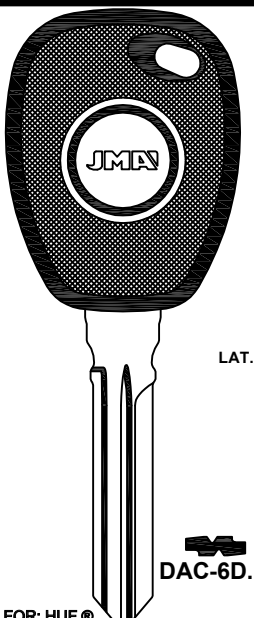
LAT.

DAC-6D.P

FOR: HUF®

TP00

FOR: DAEWOO®

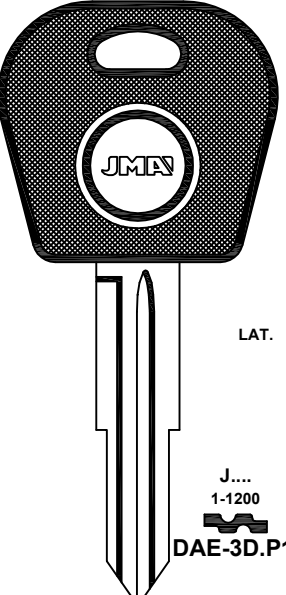



LAT.

J....
1-1200

DAE-3D.P1

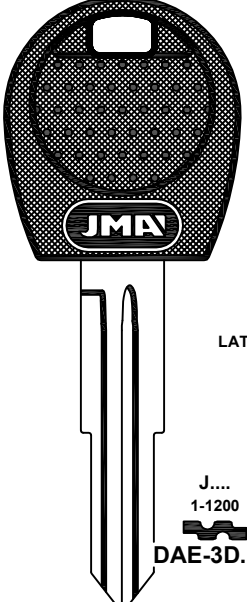
TPX8+
TPX8
TPX6
TPX5
TPX2
TPM1
TP19
TP08
TP05
TP03
TP00



LAT.





J....
1-1200

DAE-3D.P4



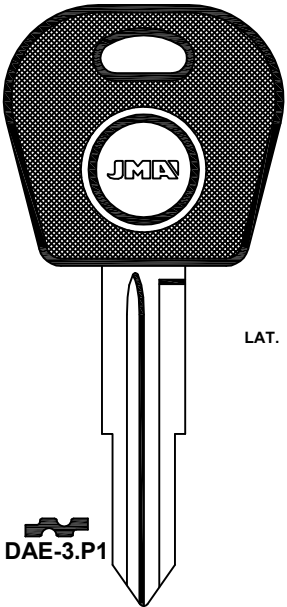
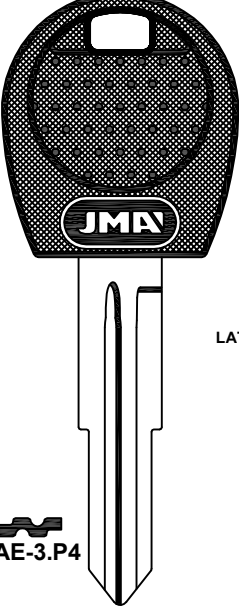
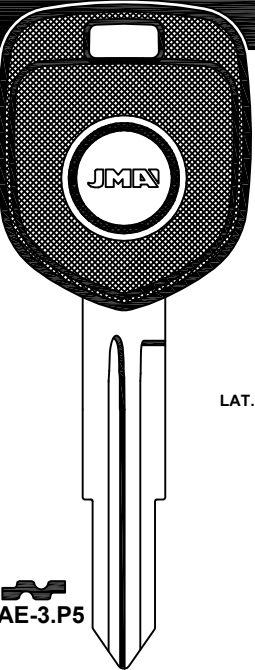

TPX5
TPX4
TPM1
TP12NS
TP08
TP00



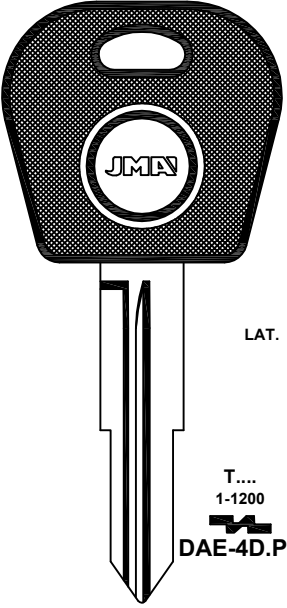
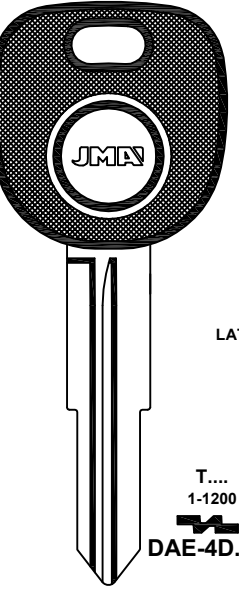
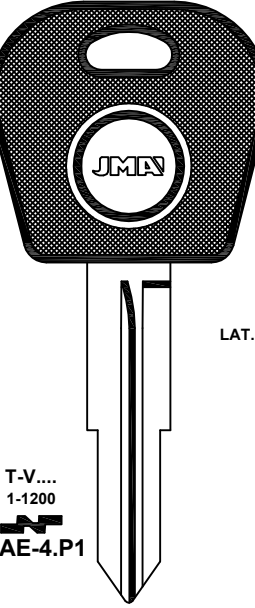

FOR:
DAEWOO®
DAIHATSU®

FOR: DAEWOO®

| | | | | | |
|---|------|--|------|--|------|
|  DAE-3.P1 | LAT. |  DAE-3.P4 | LAT. |  DAE-3.P5 | LAT. |
|  TP32 TP00 | |  TPX8+ TPX8 TP08 TP00 | |  TPX8+ TPX8 TP32CS TP00 | |

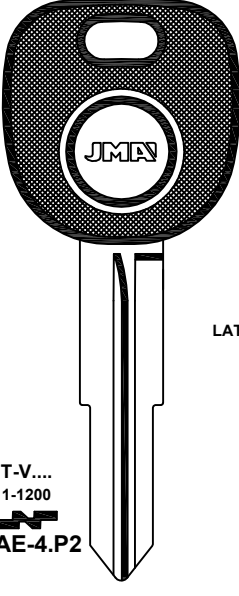
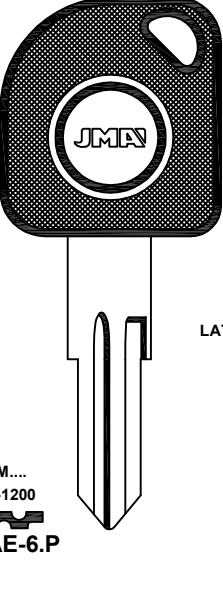
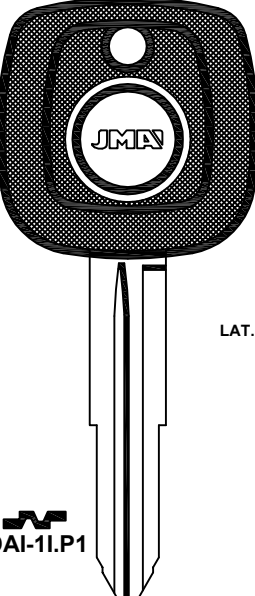
FOR: DAEWOO®

| | | | | | |
|--|------|--|------|--|------|
|  DAE-4D.P1 | LAT. |  DAE-4D.P2 | LAT. |  DAE-4.P1 | LAT. |
| T.... 1-1200  TP05 TP03 TP00 | | T.... 1-1200  TPX5 TPX4 TP12GM TP12 TP00 | | T-V.... 1-1200  TPX6 TPX5 TPX4 TPX2 TPM1 TP19 TP12GM TP08 TP05 TP03 TP00 | |

| | | | | | |
|--|------|---|------|---|------|
| <p style="text-align: center;">FOR: DAEWOO®</p>  DAE-4.P2 | LAT. | <p style="text-align: center;">FOR: DAEWOO®</p>  DAE-6.P | LAT. | <p style="text-align: center;">FOR: DAIHATSU®</p>  DAI-11.P1 | LAT. |
| T-V.... 1-1200  TP00 | | M.... 1-1200  TPM1 TP08 TP05 TP03 TP00 | |  TP00 | |



| FOR: DAIHATSU ® | | FOR: DUCATI ® | |
|------------------------|------|---------------------------|------|
| | | | |
| D...1-2000 DAI-1.P1 | LAT. | D...3001-4000 DAI-3.P1 | LAT. |
| TPX6 | | TPX6 | |
| TPX5 | | TPX5 | |
| TPX2 | | TPX1 | |
| TPX1 | | TP07 | |
| TP30 | | TP00 | |
| TP07 | | | |
| TP00 | | | |

FOR:
DAIHATSU ®
DUCATI ®
FAB ®
FORD ®

| FOR: FAB ® | | FOR: FORD ® | |
|------------------------------|------|-------------------------------|------|
| | | | |
| 4AE... 1-2780 SKO-5.P1 | LAT. | ...X 0001-1706 FO-15D.P | LAT. |
| TP05 | | TPX6 | |
| TP00 | | TPX5 | |
| | | TPX2 | |
| | | TPX1 | |
| | | TP20 | |
| | | TP19 | |
| | | TP06 | |
| | | TP02 | |
| | | TP00 | |

| FOR: FORD ® | | FOR: FORD ® | |
|---|------|-------------------------------|------|
| | | | |
| ...A... 101-291 501-579 ...B... 101-332 501-602 ...C... 101-344 501-624 ...D... 101-327 501-602 ...E... 101-296 501-579 | LAT. | ...X 0001-1706 FO-15D.P | LAT. |
| TPX6 | | TPX7 | |
| TPX5 | | TPX6 | |
| TPX1 | | TPX5 | |
| TP02 | | TPX2 | |
| | | TPX1 | |
| | | TP33 | |
| | | TP20 | |
| | | TP02 | |
| | | TP00 | |



Atención: Concerniente a las marcas y denominaciones comerciales ver nota en índice.
Attention: Concerning the marks and commercial denominations see note in index.
Attention: Concernant les marques et dénominations commerciales voir la note dans l'index.
Achtung: Bezüglich der Marke und des Handelsnamens achten Sie bitte auf die Hinweise im Index.
Atenção: Relativamente às marcas e denominações comerciais, ver nota no índice.
Uwaga: W zależności od marki i nazwy handlowej należy zapoznać się z notą w indeksie

| | | | | | |
|---------------------------|--|---|--|-------------|--|
| FOR: HONDA® | | FOR: HONDA® | | FOR: HONDA® | |
| | | | | | |
| ALP. | | LAT. | | LAT. | |
| TPX8+ | | TPX5 | | TPX5 | |
| TPX8 | | TPX4 | | TPX4 | |
| TPX5 | | TP12HN | | TP12HN | |
| TPX4 | | TP00 | | TP00 | |
| TP38 | | | | | |
| TP32 | | | | | |
| TP12HN | | | | | |
| TP08 | | | | | |
| TP05 | | | | | |
| TP03 | | | | | |
| TP00 | | | | | |
| ...K001-N718 HOND-31.P | |5001-8442123 HOND-53.P1 | | HOND-54.P1 | |

FOR:
HONDA®
HUF®

| | | | | | |
|-------------|------|-------------|--|--------------------|-------------|
| FOR: HONDA® | | FOR: HONDA® | | FOR: HONDA® | |
| | | | | | |
| ALP. | | LAT. | | LAT. | |
| | | | | R.... 6001-8000 | |
| TPX5 | | TPX5 | | TPX5 | |
| TPX4 | | TPX4 | | TPX4 | |
| TP12HN | | TP12HN | | TP12HN | |
| TP00 | | TP00 | | TP00 | |
| HOND-55.P | | HOND-56.P | | NE-35.P3 | |
| | | | | FOR: NEIMAN® | FOR: VALEO® |

| | | | | | |
|-------------------------------|--|-----------|--|-----------|--|
| FOR: HUF® | | FOR: HUF® | | FOR: HUF® | |
| | | | | | |
| LAT. | | LAT. | | LAT. | |
| AH.... 1-8154 1001-9282 | | BM-5.P4 | | BM-6.P | |
| TP05 | | TPX5 | | TPX5 | |
| TP03 | | TPX4 | | TPX4 | |
| TP00 | | TP12 | | TP12 | |
| | | TP00 | | TP00 | |
| AU-AH.P2 | | | | | |



FOR:
HUF®







| FOR: HUF® | | FOR: HUF® | | FOR: HUF® | |
|-----------|------|-----------|------|-----------|------|
| | | | | | |
| LAT. | | ALP. | | ALP. | |
| BM-6.P6 | TPX5 | BM-6RKE | TPX5 | BM-6RKE1 | TPX5 |
| | TPX4 | | TPX4 | | TPX4 |
| | TP12 | | TP12 | | TP12 |
| | TP00 | | TP00 | | TP00 |

| FOR: HUF® | | FOR: HUF® | | FOR: HUF® | |
|-----------------------------|------|-----------------------------|------|-----------------------------|------|
| | | | | | |
| ALP. ACE. | | | | ALP. | |
| T.... 1 AL 4 001-1050 | TPX7 | T.... 1 AL 4 001-1050 | TPX6 | T.... 1 AL 4 001-1050 | TPX5 |
| FO-6.P | TPX5 | FO-6.TL | TPX2 | FO-6.TL2 | TPX1 |
| FOR: TIBBE® | TPX1 | FOR: TIBBE® | TP33 | | TP20 |
| | TP06 | | TP20 | | TP06 |
| | TP02 | | TP02 | | TP02 |
| | TP00 | | TP00 | | TP00 |

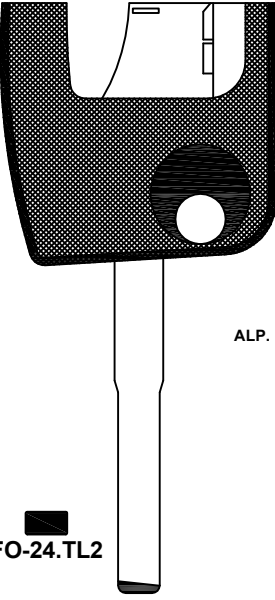
| FOR: HUF® | | FOR: HUF® | | FOR: HUF® | |
|-------------|------|-----------|------|-----------|------|
| | | | | | |
| ALP. | | ALP. | | LAT. | |
| FO-24.P | TPX7 | FO-24.P2 | TPX6 | FO-24.TL | TPX5 |
| FOR: VALEO® | TPX4 | | TPX2 | | TPX3 |
| | TP33 | | TP33 | | TP00 |
| | TP20 | | TP20 | | |
| | TP12 | | TP12 | | |
| | TP00 | | TP00 | | |

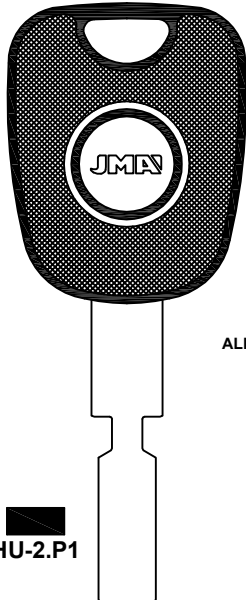

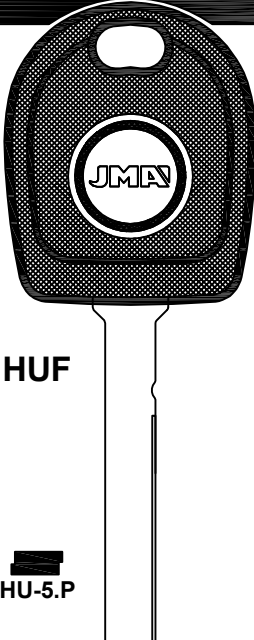





FOR: HUF®

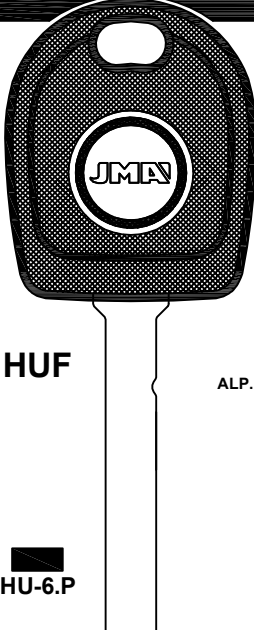

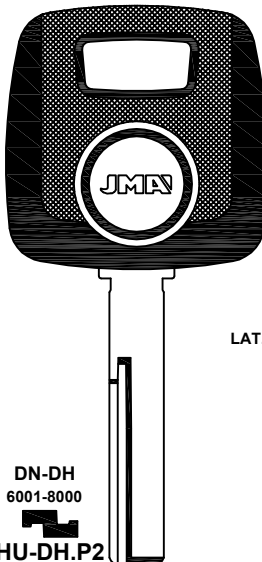

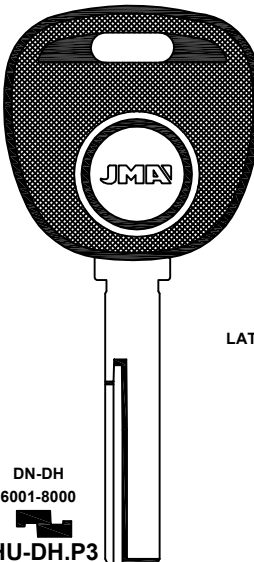

| | | | | | | | | | |
|--|---|--|---|--|---|------|------|------|------|
|  <p>ALP.</p> <p>FO-24.TL2</p> |  |  <p>ALP.</p> <p>HU-2.P1</p> |  |  <p>HUF</p> <p>HU-5.P</p> |  | | | | |
| | TPX7 | | TPX6 | | TPX5 | TPX2 | TP33 | TP20 | TP00 |
| | TPX6 | | TPX5 | | TPX2 | TP19 | TP00 | | |
| | | | | | | | | | |
| | | | | | | | | | |
| | | | | | | | | | |
| | | | | | | | | | |
| | | | | | | | | | |

**FOR:
HUF®**

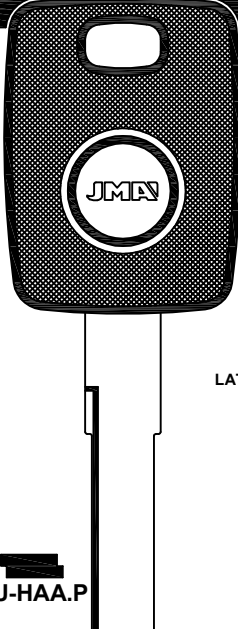
FOR: HUF®

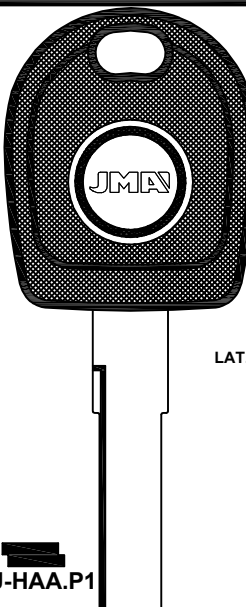
| | | | | | | | |
|---|---|--|---|---|---|--|--|
|  <p>HUF</p> <p>ALP.</p> <p>HU-6.P</p> |  |  <p>LAT.</p> <p>DN-DH 6001-8000 HU-DH.P2</p> |  |  <p>LAT.</p> <p>DN-DH 6001-8000 HU-DH.P3</p> |  | | |
| | | | | | | | |
| | | | | | | | |
| | | | | | | | |
| | | | | | | | |
| | | | | | | | |
| | | | | | | | |
| | | | | | | | |

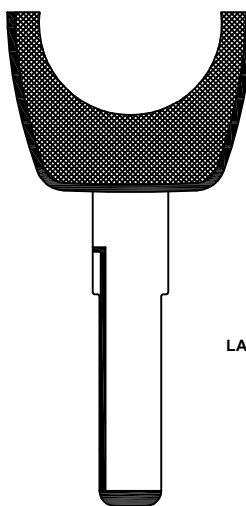
FOR: HUF®



| | | | | | | | |
|---|---|--|---|---|---|--|--|
|  <p>LAT.</p> <p>HU-HAA.P</p> |  |  <p>LAT.</p> <p>HU-HAA.P1</p> |  |  <p>LAT.</p> <p>HU-HAA.TL</p> |  | | |
| | | | | | | | |
| | | | | | | | |
| | | | | | | | |
| | | | | | | | |
| | | | | | | | |
| | | | | | | | |
| | | | | | | | |
| | | | | | | | |
| | | | | | | | |
| | | | | | | | |
| | | | | | | | |



FOR:
HUF®

FOR: HUF®

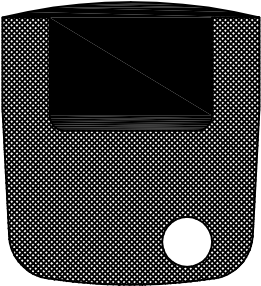
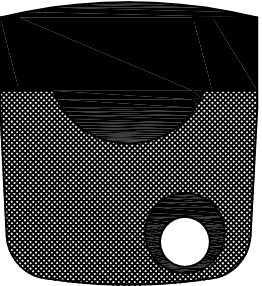

| | | | | | | |
|---|--|---|--|---|--|--|
|  ALP. 180° HU-HAA.TLN | |  ALP. 180° HU-HAA.TLV | |  ALP. HU-HCA.P | | |
| | | | | | | |
| | | | | | | |
| | | | | | | |
| | | | | | | |
| | | | | | | |
| | | | | | | |
| | | | | | | |
| | | | | | | |
| | | | | | | |
| | | | | | | |

FOR: HUF®

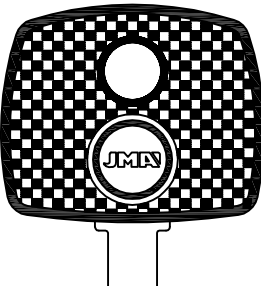
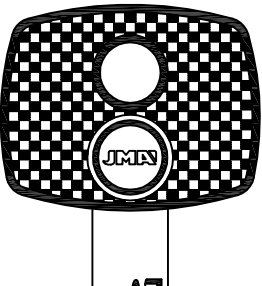
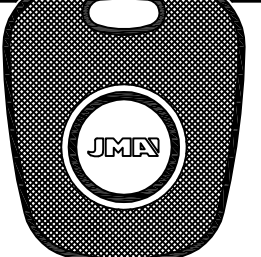

| | | | | | | |
|--|--|---|--|---|--|--|
|  LAT. 0001-03555 3501-6700 ME-7.P1 FOR: YMOS® | |  LAT. ME-9.P1 | |  LAT. ME-16.P FOR: YMOS® | | |
| | | | | | | |
| | | | | | | |
| | | | | | | |
| | | | | | | |
| | | | | | | |
| | | | | | | |
| | | | | | | |
| | | | | | | |
| | | | | | | |
| | | | | | | |

FOR: HUF®



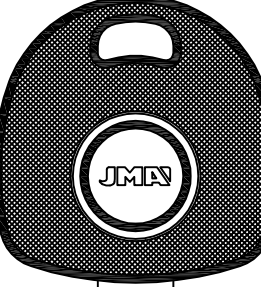
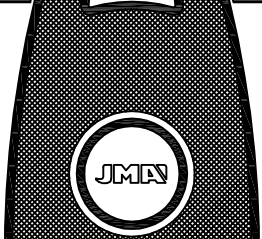
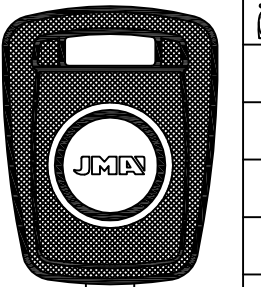

FOR: HUF®



| | | | | | | |
|---|--|--|--|--|--|--|
|  LAT. 50001-51308 OP-10.P FOR: YMOS® | |  ALP. Z.... 1-2000 2001-4000 4001-6000 OP-11.P1 | |  ALP. Z.... 1-2000 2001-4000 4001-6000 OP-11.P2 | | |
| | | | | | | |
| | | | | | | |
| | | | | | | |
| | | | | | | |
| | | | | | | |
| | | | | | | |
| | | | | | | |
| | | | | | | |
| | | | | | | |
| | | | | | | |



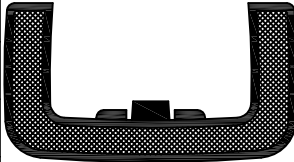



FOR: HUF®



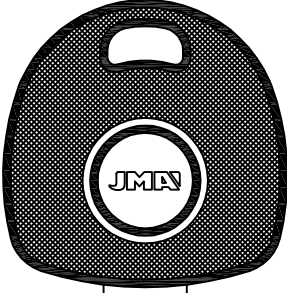

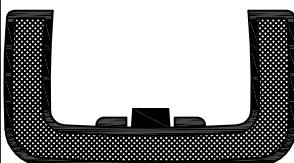
| | | | |
|--|---|--|---|
|  ALP. Z.... 1-2000 2001-4000 4001-6000  OP-11.P5 |  TPX5 TPX4 TP12NS TP12GM TP37 TP00 |  LAT. Z.... 1-2000 2001-4000 4001-6000  OP-11.TL FOR: YMOS® |  TPX5 TPX4 TP12GM TP09 TP00 |
|--|---|--|---|

**FOR:
HUF®**

FOR: HUF®



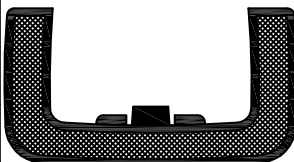



| | | | |
|--|---|--|---|
|  LAT. D.... 0001-5200  OP-D.P FOR: YMOS® |  TP09 TP05 TP01 TP00 |  LAT. D.... 0001-5200  OP-D.TL FOR: YMOS® |  TP00 TP09 TP00 |
|--|---|--|---|



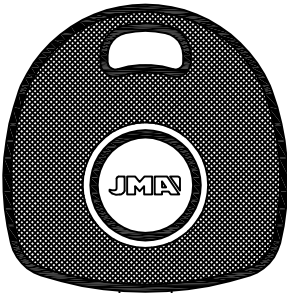

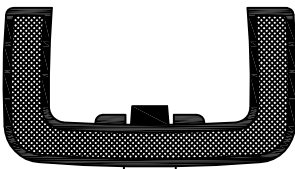

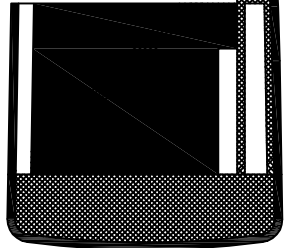
FOR: HUF®



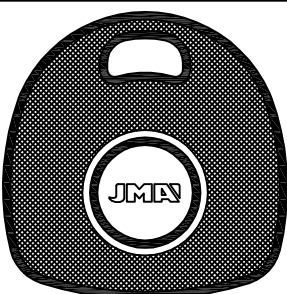



| | | | |
|---|---|--|---|
|  LAT. S.... 0001-5200  OP-S.P FOR: YMOS® |  TP09 TP05 TP03 TP01 TP00 |  LAT. S.... 0001-5200  OP-S.TL FOR: YMOS® |  TP09 TP00 TP09 TP00 |
|---|---|--|---|

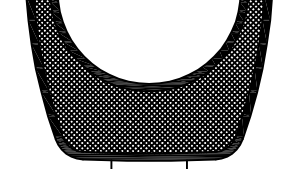

FOR:
HUF®

| FOR: HUF® | | | | | |
|---|---|---|--|---|---|
|  |  |  |  |  |  |
| LAT. | | LAT. | | | |
| H.... WH.... 0001-3000 OP-WH.P | TPX5 TPX4 TP12GM TP09 TP05 TP01 TP00 | H.... WH.... 0001-3000 OP-WH.TL | TP00 | H.... WH.... 0001-3000 OP-WH.TL2 | TP00 |
| FOR: YMOS® | | FOR: YMOS® | | FOR: YMOS® | |

| FOR: HUF® | | | | | |
|--|---|---|--|--|---|
|  |  |  |  |  |  |
| LAT. | | LAT. | | LAT. | |
| Y.... WY.... 0001-3000 OP-WY.P | TP05 TP01 TP00 | VO-2D.P | TPX8+ TPX8 TP08 TP00 | AH.... 1-8154 1001-9282 VO-2L.P | TPH1 TP10 TP00 |
| FOR: YMOS® | | | | | |

| FOR: HUF® | | | | | |
|---|---|---|--|---|---|
|  |  |  |  |  |  |
| LAT. | | LAT. | | LAT. | |
| AH.... 1-8154 1001-9282 VO-2.P | TPH1 TP14 TP10 TP05 TP00 | AH.... 1-8154 1001-9282 VO-2.TL | TP00 | 2FF VO-8.P | TPX8+ TPX8 TP08 TP00 |
| | | | | | |



| | | | | | |
|-------------------------------|--|-------------------------------|--|--------------------------------|--|
| FOR: HYUNDAI® | | FOR: HYUNDAI® | | FOR: HYUNDAI® | |
| | | | | | |
| T 0001-1000 HY-4.P1 | LAT. TPX6 TPX5 TPX4 TPX1 TP12 TP07 TP00 | R... 1-1000 HY-5.P1 | LAT. TPX6 TPX5 TPX4 TPX1 TP12 TP07 TP00 | S... 1-1000 HY-6D.P1 | LAT. TPX6 TPX5 TPX4 TPX2 TPX1 TP19 TP12 TP07 TP00 |

FOR:
HYUNDAI®

| | | | | | |
|-------------------------------|--|---|--|--|--|
| FOR: HYUNDAI® | | FOR: HYUNDAI® | | FOR: HYUNDAI® | |
| | | | | | |
| A... 1-1000 HY-9.P1 | LAT. TPX6 TPX5 TPX1 TP07 TP00 | M...1-2500 T...1-2500 WC...1001-3500 HY-11D.P1 | LAT. TPX7 TPX5 TPX4 TP46 TP12 TP00 | H...0001-2500 M...0001-2500 P...0001-2500 T...0001-2500 V...1-2500 HY-11.P1 | LAT. TPX7 TPX5 TPX4 TP46 TP12 TP00 |

| | | | | | |
|---------------|--------------------------------------|------------------------------------|--------------------------------------|---------------|--|
| FOR: HYUNDAI® | | FOR: HYUNDAI® | | FOR: HYUNDAI® | |
| | | | | | |
| HY-11RKE | LAT. TPX5 TPX4 TP12 TP00 | WA... 1001-3040 HY-12.P1 | LAT. TPX5 TPX4 TP12 TP00 | HY-18.P | LAT. TPX7 TPX5 TPX4 TP46 TP12 TP00 |



FOR:
HYUNDAI®
ISUZU®
KAWASAKI®

| FOR: HYUNDAI® | | FOR: HYUNDAI® | | FOR: HYUNDAI® | |
|---------------|--|----------------|--|----------------|--|
| | | | | | |
| ALP. | | LAT. | | LAT. | |
| TPX5 | | TPX7 | | TPX7 | |
| TPX4 | | TPX5 | | TPX5 | |
| TP12 | | TPX4 | | TPX4 | |
| TP00 | | TP46 | | TP46 | |
| | | TP12 | | TP12 | |
| | | TP00 | | TP00 | |
| HY-18RKE | | HY-19D.P1 | | HY-19.P1 | |
| | | | | C1001-C3500 | |
| FOR: HYUNDAI® | | FOR: ISUZU® | | FOR: ISUZU® | |
| | | | | | |
| LAT. | | LAT. | | LAT. | |
| 7.8 | | TPX5 | | TPX8+ | |
| 2.95 | | TPX4 | | TPX8 | |
| HY-20.P1 | | TP12GM | | TP08 | |
| | | TP00 | | TP00 | |
| | | ISU-3D.P1 | | ISU-3D.P2 | |
| FOR: ISUZU® | | FOR: KAWASAKI® | | FOR: KAWASAKI® | |
| | | | | | |
| LAT. | | LAT. | | LAT. | |
| TPX5 | | Z..... | | TPX6 | |
| TPX4 | | 5000-6000 | | TPX5 | |
| TP12 | | KAW-9.P1 | | TPX2 | |
| TP00 | | | | TP00 | |
| ISU-5.P3 | | | | KAW-16.P1 | |



| FOR: KIA® | | FOR: KIA® | | FOR: KIA® | |
|--|---|---|---|---|--|
| | <p>TPX6</p> <p>TPX5</p> <p>TPX4</p> <p>TPX2</p> <p>TPM1</p> <p>TP19</p> <p>TP12</p> <p>TP08</p> <p>TP06</p> <p>TP05</p> <p>TP03</p> <p>TP00</p> | | <p>TPX5</p> <p>TPX4</p> <p>TP12</p> <p>TP05</p> <p>TP03</p> <p>TP00</p> | | <p>TPX6</p> <p>TPX5</p> <p>TPX4</p> <p>TPX2</p> <p>TPAE1</p> <p>TP36</p> <p>TP19</p> <p>TP12</p> <p>TP12MT</p> <p>TP00</p> |
| <p>LAT.</p> <p>Y....</p> <p>2001-3000</p> <p></p> <p>KI-2D.P</p> | | <p>LAT.</p> <p></p> <p>KI-2.P</p> | | <p>LAT.</p> <p>K....0001-2500</p> <p>P....0001-2500</p> <p></p> <p>KI-7.P</p> | |
| FOR: KIA® | | FOR: MAHINDRA® | | FOR: MAHINDRA® | |
| | | | <p>TPX6</p> <p>TPX5</p> <p>TPX4</p> <p>TPX2</p> <p>TP19</p> <p>TP12</p> <p>TP00</p> | | <p>TPX8+</p> <p>TPX8</p> <p>TP08</p> <p>TP00</p> |
| <p>LAT.</p> <p></p> <p>KI-8D.P</p> | | <p>LAT.</p> <p></p> <p>KI-9.P</p> | | <p>LAT.</p> <p></p> <p>MHN-1.P</p> | |
| FOR: MAZDA® | | | | | |
| | | | <p>TPT1</p> <p>TP17</p> <p>TP05</p> <p>TP04</p> <p>TP00</p> | | <p>TP00</p> |
| <p>LAT.</p> <p>....</p> <p>10100-12283</p> <p></p> <p>MAZ-9D.P</p> | | <p>LAT.</p> <p>....</p> <p>10100-12099</p> <p></p> <p>MAZ-10D.P</p> | | <p>LAT.</p> <p>....</p> <p>10100-12099</p> <p></p> <p>MAZ-10D.P2</p> | |







FOR:
KIA®
MAZDA®



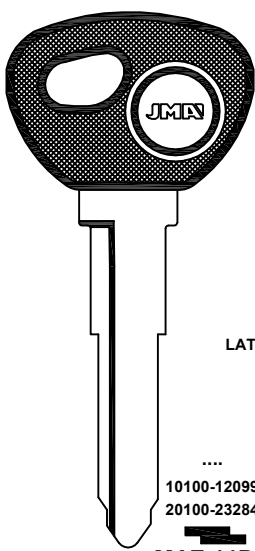

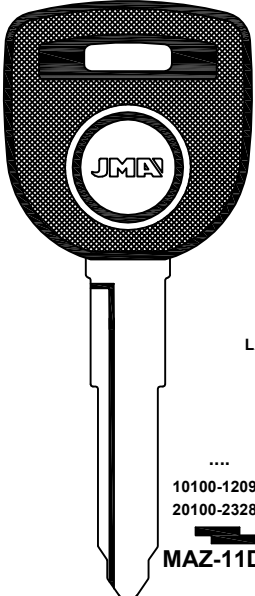

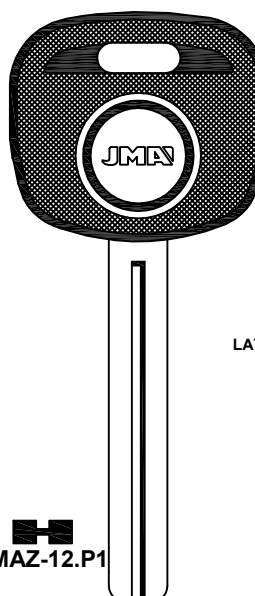

Atención: Concerniente a las marcas y denominaciones comerciales ver nota en índice.
 Attention: Concerning the marks and commercial denominations see note in index.
 Attention: Concernant les marques et dénominations commerciales voir la note dans l'index.
 Achtung: Bezüglich der Marke und des Handelsnamens achten Sie bitte auf die Hinweise im Index.
 Atencão: Relativamente às marcas e denominações comerciais, ver nota no índice.
 Uwaga: W zależności od marki i nazwy handlowej należy zapoznać się z notą w indeksie



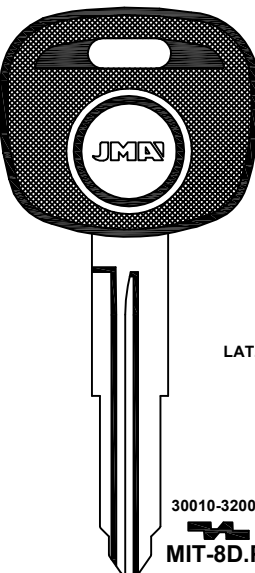

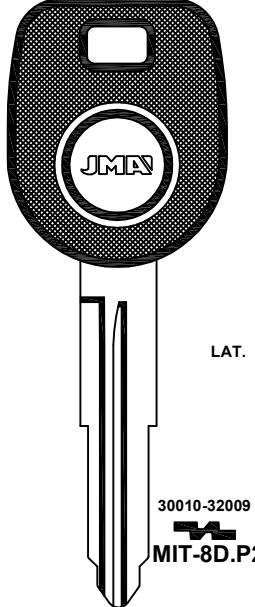

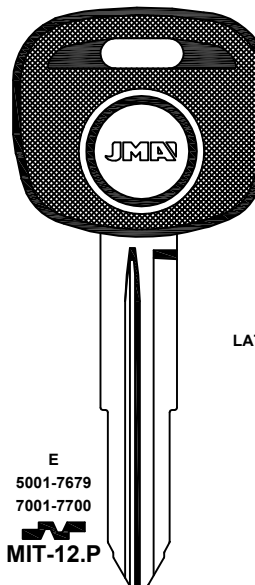
FOR:
MAZDA®
MITSUBISHI®
NEIMAN®

FOR: MAZDA®

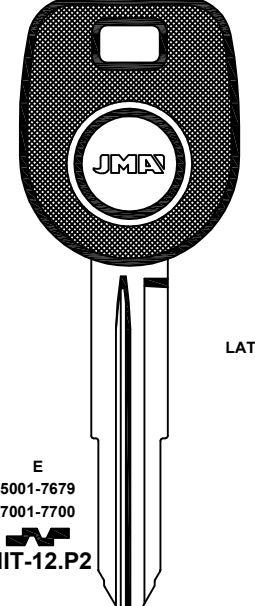
| | | | | | |
|--|--|---|--|---|--|
|  <p style="text-align: center;">LAT.</p> <p style="text-align: center;">..... 10100-12099 20100-23284</p> <p style="text-align: center;">MAZ-11D.P</p> |  |  <p style="text-align: center;">LAT.</p> <p style="text-align: center;">..... 10100-12099 20100-23284</p> <p style="text-align: center;">MAZ-11D.P2</p> |  |  <p style="text-align: center;">LAT.</p> <p style="text-align: center;">MAZ-12.P1</p> |  |
| | <ul style="list-style-type: none"> TPX6 TPX5 TPX2 TPT1 TP20 TP17 TP05 TP04 TP01 TP00 | | <ul style="list-style-type: none"> TPX6 TPX5 TPX2 TPT1 TP20 TP17 TP00 | | <ul style="list-style-type: none"> TP05 TP04 TP01 TP00 |

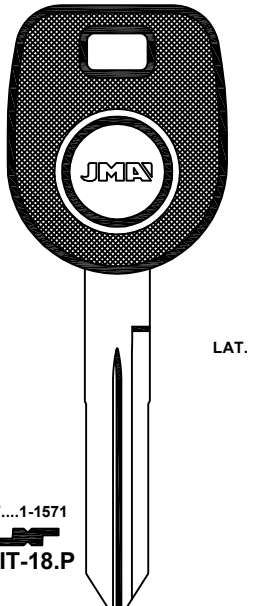
FOR: MITSUBISHI®

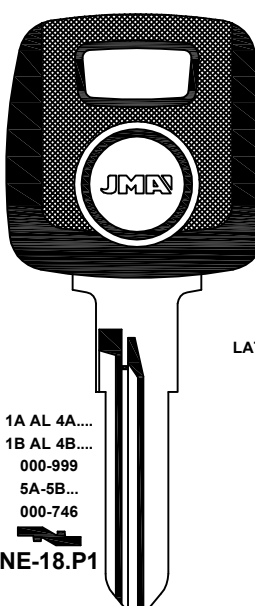
| | | | | | |
|---|--|---|--|--|--|
|  <p style="text-align: center;">LAT.</p> <p style="text-align: center;">30010-32009</p> <p style="text-align: center;">MIT-8D.P1</p> |  |  <p style="text-align: center;">LAT.</p> <p style="text-align: center;">30010-32009</p> <p style="text-align: center;">MIT-8D.P2</p> |  |  <p style="text-align: center;">LAT.</p> <p style="text-align: center;">E 5001-7679 7001-7700</p> <p style="text-align: center;">MIT-12.P</p> |  |
| | <ul style="list-style-type: none"> TPX6 TPX5 TPX4 TPX2 TPX1 TP26 TP19 TP12MT TP07 TP00 | | <ul style="list-style-type: none"> TPX5 TPX4 TPX2 TPX1 TP26 TP12 TP12MT TP07 TP00 | | <ul style="list-style-type: none"> TPX6 TPX5 TPX4 TPX2 TPX1 TP28 TP26 TP12MT TP07 TP00 |

| | | | | | |
|--|--|---|--|--|---|
|  <p style="text-align: center;">LAT.</p> <p style="text-align: center;">E 5001-7679 7001-7700</p> <p style="text-align: center;">MIT-12.P2</p> |  |  <p style="text-align: center;">LAT.</p> <p style="text-align: center;">F....1-1571</p> <p style="text-align: center;">MIT-18.P</p> |  |  <p style="text-align: center;">LAT.</p> <p style="text-align: center;">1A AL 4A.... 1B AL 4B.... 000-999 5A-5B... 000-746</p> <p style="text-align: center;">NE-18.P1</p> |  |
| | <ul style="list-style-type: none"> TPX6 TPX5 TPX4 TPX2 TP28 TP26 TP19 TP12MT TP00 | | <ul style="list-style-type: none"> TPX6 TPX5 TPX4 TPX2 TP26 TP19 TP12MT TP00 | | <ul style="list-style-type: none"> TP05 TP01 TP00 |



| | | | | | |
|--|---|--|---|--|---|
| FOR: NEIMAN® | | FOR: NEIMAN® | | FOR: NEIMAN® | |
| | | | | | |
| <p>.....1/9..A/Z ..1/9.... 1/9.....A/Z .1/9.....A/Z ..1/9....A/Z ...1/9..A/Z1/9..A/Z1/9..A/Z A/Z</p> <p>NE-36.P2</p> | <p>LAT.</p> <p>TPX5 TPX4 TPH1 TP16 TP12RN TP12 TP05 TP01 TP00</p> | <p>.....1/9..A/Z ..1/9.... 1/9.....A/Z .1/9.....A/Z ..1/9....A/Z ...1/9..A/Z1/9..A/Z1/9..A/Z A/Z</p> <p>NE-38.P4</p> | <p>LAT.</p> <p>TPX8+ TPX8 TPX6 TPX5 TPX4 TPX2 TP21 TP19 TP12RN TP12NS TP08 TP05 TP01 TP00</p> | <p>ALP.</p> <p>1 AL 5V 1-12295</p> <p>NE-40.P1</p> <p>FOR: VALEO® - YMOS®</p> | <p>TPX8+ TPX8 TP08 TP05 TP01 TP00</p> |

FOR:
NEIMAN®
NISSAN®

| | | | | | |
|------------------------|----------------------------------|------------------------------------|--|---|--|
| FOR: NEIMAN® | | FOR: NEIMAN® | | FOR: NEIMAN® | |
| | | | | | |
| <p>NE-45.P1</p> | <p>LAT.</p> <p>TP05 TP00</p> | <p>ALP.</p> <p>NE-51.P2</p> | <p>TPX8+ TPX8 TPX5 TPX4 TPH1 TP16 TP12 TP08 TP05 TP01 TP00</p> | <p>LAT.</p> <p>L..... 8001-10000</p> <p>NE-52.P2</p> | <p>TPX5 TPX4 TP12 TP00</p> |

| | | | | | |
|--|---|--|-------------------------|--|---|
| FOR: NISSAN® | | | | | |
| | | | | | |
| <p>X....1-8000 X....8001-9000</p> <p>DAT-6.P2</p> | <p>LAT.</p> <p>TPX6 TPX5 TPX4 TPX2 TPX1 TPH1 TP19 TP13 TP12NS TP07 TP05 TP01 TP00</p> | <p>X....1-8000 X....8001-9000</p> <p>DAT-6.P4</p> | <p>LAT.</p> <p>TP00</p> | <p>LAT.</p> <p>.....1-22185</p> <p>DAT-15.P2</p> <p>FOR: VALEO®</p> | <p>TPX6 TPX5 TPX4 TPX2 TPH1 TP19 TP13 TP12NS TP05 TP01 TP00</p> |







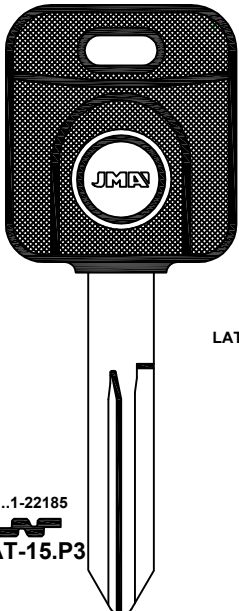
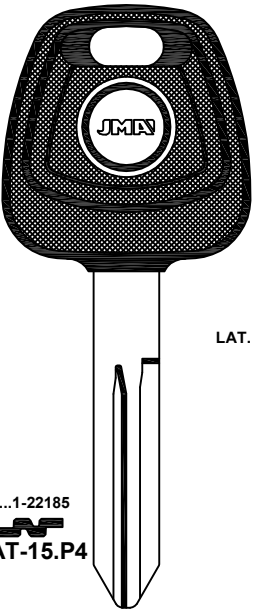
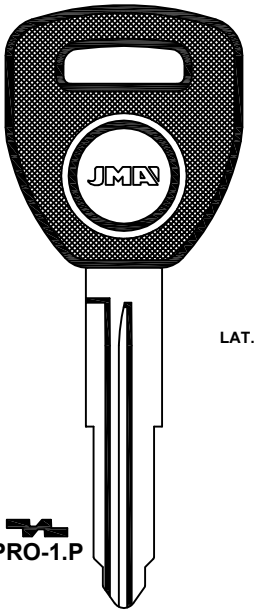
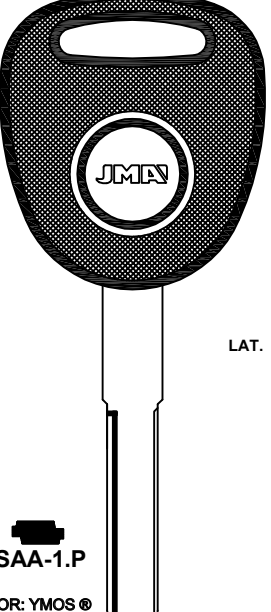
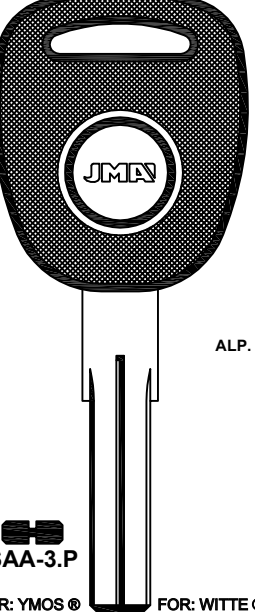
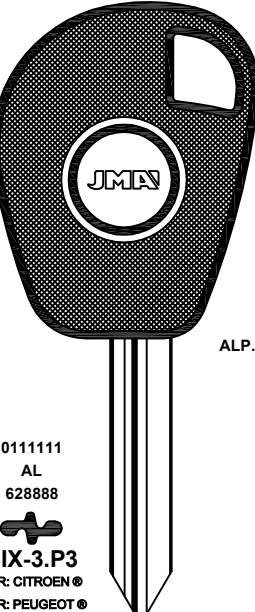
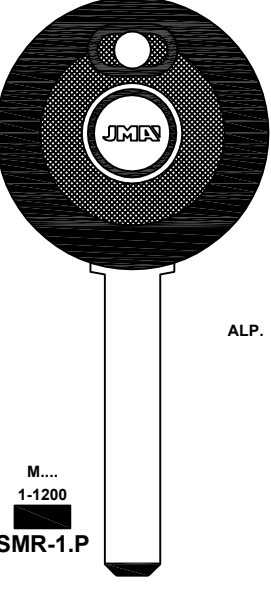
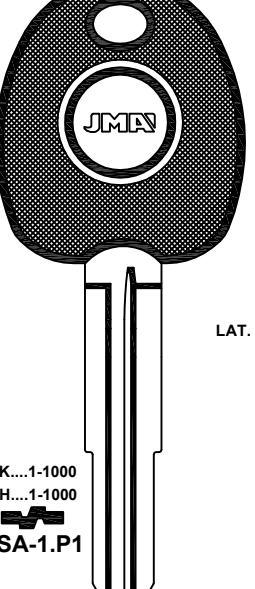
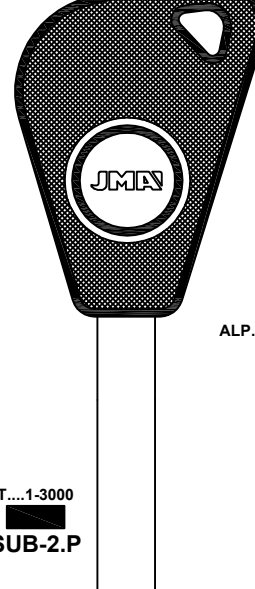

Atención: Concerniente a las marcas y denominaciones comerciales ver nota en índice.
 Attention: Concerning the marks and commercial denominations see note in index.
 Attention: Concernant les marques et dénominations commerciales voir la note dans l'index.
 Achtung: Bezüglich der Marke und des Handelsnamens achten Sie bitte auf die Hinweise im Index.
 Atencão: Relativamente às marcas e denominações comerciais, ver nota no índice.
 Uwaga: W zależności od marki i nazwy handlowej należy zapoznać się z notą w indeksie

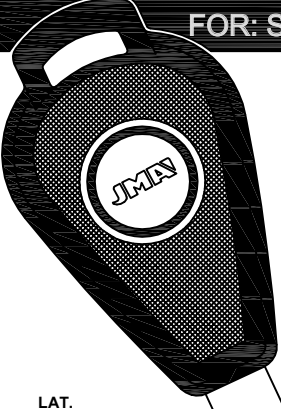

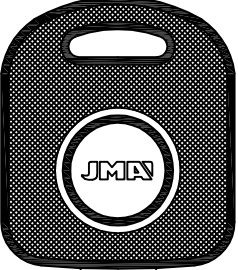

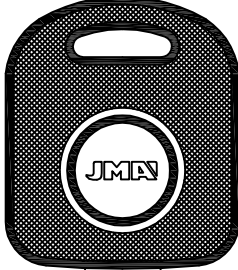

FOR:
 NISSAN ®
 PROTON ®
 SAAB ®
 SIMPLEX ®
 SMART ®
 SSANGYONG ®
 SUBARU ®



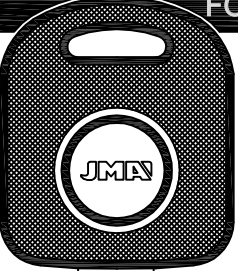

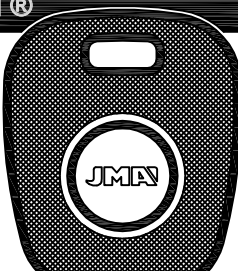

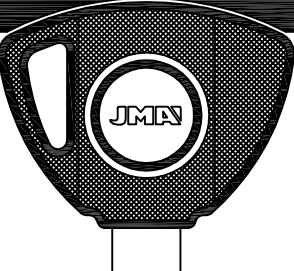
| FOR: NISSAN ® | | FOR: PROTON ® | |
|---|--|---|---|
|  |1-22185 DAT-15.P3 |  |  |
| LAT. | TPX6 TPX5 TPX4 TPX2 TP19 TP12NS TP00 | LAT. | TPX6 TPX5 TPX2 TP19 TP07 TP00 |
| FOR: SAAB ® | | FOR: SIMPLEX ® | |
|  | TP05SA TP05 TP03 TP00 |  |  |
| LAT. | SAA-1.P FOR: YMOS ® | ALP. | 0111111 AL 628888 SIX-3.P3 FOR: CITROEN ® FOR: PEUGEOT ® |
| FOR: SMART ® | | FOR: SSANGYONG ® | |
|  | M.... 1-1200 SMR-1.P |  |  |
| ALP. | TPX5 TPX4 TP12 TP00 | LAT. | TPX8+ TPX8 TPX6 TPX5 TPX2 TP19 TP08 TP00 |
| FOR: SUBARU ® | | | |
| | SK....1-1000 KH....1-1000 SSA-1.P1 | | T....1-3000 SUB-2.P |



| FOR: SUBARU® | | FOR: SUZUKI® | | FOR: SUZUKI® | |
|---|---|--|---|--|---|
|  <p>LAT.</p> <p>.....1-22185</p> <p>SUB-3.P2</p> |  |  <p>LAT.</p> <p>.....</p> <p>18100-19229</p> <p>SUZU-8I.P1</p> |  |  <p>LAT.</p> <p>.....</p> <p>18100-19229 19300-19617</p> <p>SUZU-8.P1</p> |  |
| | TPX6 | | TPX6 | | TPX6 |
| | TPX5 | | TPX5 | | TPX5 |
| | TPX2 | | TPX2 | | TPX2 |
| | TP28 | | TP27 | | TPX4 |
| | TP19 | | TP27 | | TPX1 |
| TP00 | TP00 | TP00 | | | |











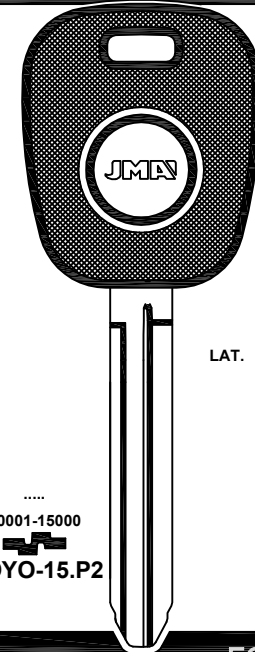
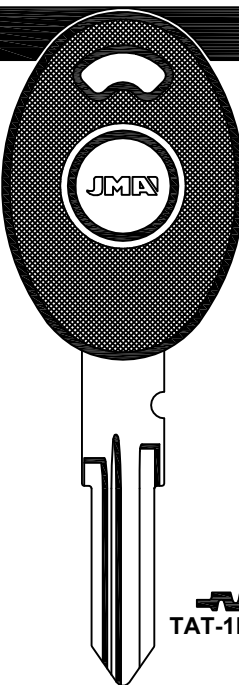
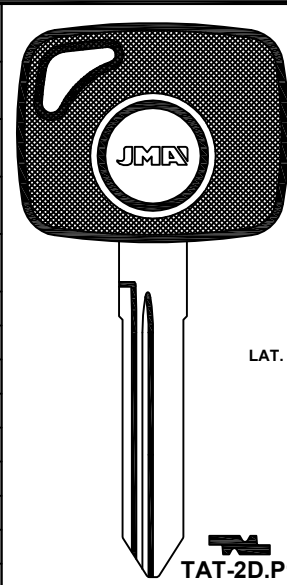
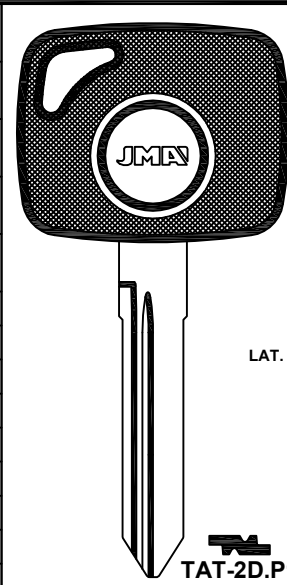

FOR:
SUBARU®
SUZUKI®

| FOR: SUZUKI® | | FOR: SUZUKI® | | FOR: SUZUKI® | |
|---|---|--|---|--|---|
|  <p>LAT.</p> <p>U.... 1-2000</p> <p>SUZU-10.P1</p> |  |  <p>LAT.</p> <p>.....50001-51308</p> <p>U....1-2000 V....1-2000</p> <p>SUZU-14.P2</p> |  |  <p>LAT.</p> <p>SUZU-15D.P</p> |  |
| | TPX6 | | TPX6 | | TPX6 |
| | TPX5 | | TPX5 | | TPX5 |
| | TPX2 | | TPX2 | | TPX2 |
| | TPX1 | | TPX1 | | TPX2 |
| | TP21 | | TP21 | | TPX5 |
| TP07 | TP07 | TPX2 | | | |
| TP00 | TP00 | TP00 | | | |

| FOR: SUZUKI® | | FOR: SUZUKI® | | FOR: SUZUKI® | |
|---|---|--|---|--|---|
|  <p>LAT.</p> <p>SUZU-17D.P2</p> |  |  <p>LAT.</p> <p>SUZU-17.P2</p> |  |  <p>LAT.</p> <p>SUZU-20D.P2</p> |  |
| | TPX6 | | TPX6 | | TPX6 |
| | TPX5 | | TPX5 | | TPX5 |
| | TPX2 | | TPX2 | | TPX2 |
| | TP27 | | TP27 | | TPX4 |
| | TP05 | | TP05 | | TP12NS |
| TP00 | TP00 | TP00 | | | |

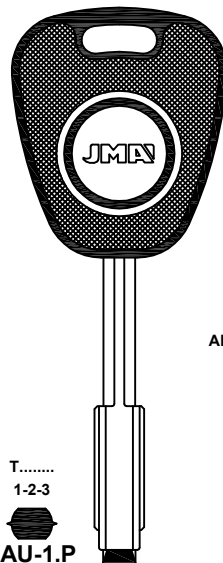
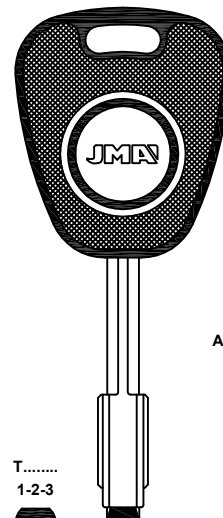
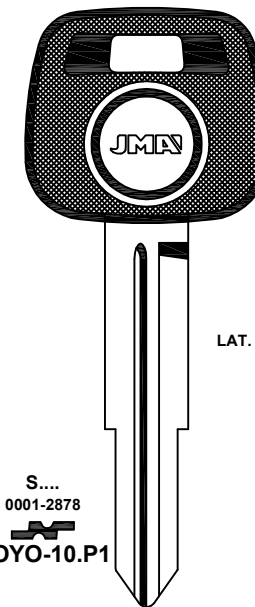
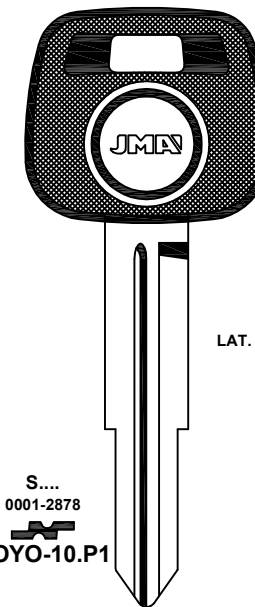

FOR:
SUZUKI®
TATA®
TIBBE®
TOYOTA®

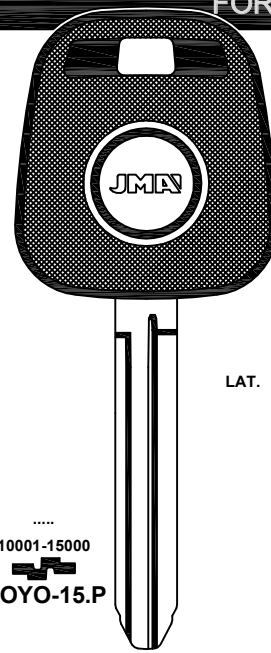
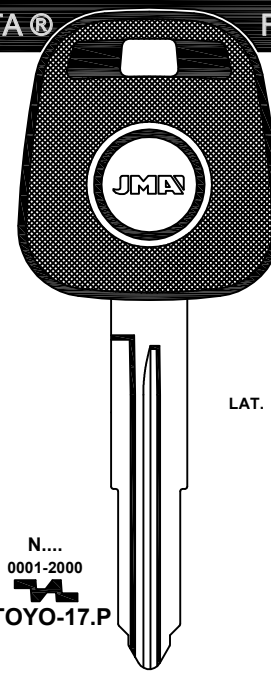
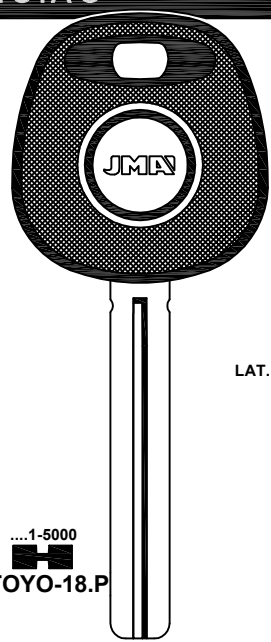
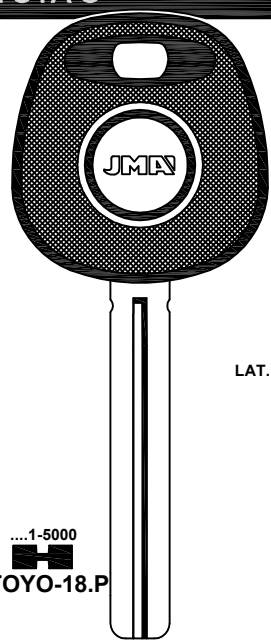
| FOR: SUZUKI® | | FOR: TATA® | |
|---|--|---|---|
|  |  |  |  |
|  |  |  |  |
| LAT. | LAT. | LAT. | LAT. |
| 10001-15000 TOYO-15.P2 | TAT-1D.P2 | TAT-2D.P1 | |
| TPX6 | TPX5 | TPX5 | TPX5 |
| TPX5 | TPX4 | TPX4 | TPX4 |
| TPX4 | TPX2 | TP12 | TP12 |
| TPX2 | TP27 | TP00 | TP05 |
| TP12SZ | TP00 | TP00 | TP00 |
| TP00 | | | |
| FOR: TIBBE® | | FOR: TOYOTA® | |
|  |  |  |  |
|  |  |  |  |
| ALP. | ALP. | LAT. | LAT. |
| T..... 1-2-3 JAU-1.P | T..... 1-2-3 JAU-2.P | S.... 0001-2878 TOYO-10.P1 | |
| FOR: VALEO® | FOR: VALEO® | | |
| TPX8+ | TPX6 | TP05 | TP05 |
| TPX8 | TPX5 | TP01 | TP01 |
| TPX6 | TPX2 | TP00 | TP00 |
| TPX5 | TP08 | | |
| TPX2 | TP06 | | |
| TP08 | TP05 | | |
| TP06 | TP03 | | |
| TP05 | TP00 | | |
| TP03 | | | |
| TP00 | | | |
| FOR: TOYOTA® | | FOR: TOYOTA® | |
|  |  |  |  |
|  |  |  |  |
| LAT. | LAT. | LAT. | LAT. |
| 10001-15000 TOYO-15.P | N.... 0001-2000 TOYO-17.P |1-5000 TOYO-18.P | |
| TPG1 | TPX6 | TPX6 | TPX6 |
| TPAE1 | TPX5 | TPX5 | TPX5 |
| TPX6 | TPX2 | TPX1 | TPX1 |
| TPX5 | TPX1 | TP07 | TP07 |
| TPX2 | TP36 | TP00 | TP00 |
| TPX1 | TP34 | | |
| TP36 | TP30 | | |
| TP34 | TP07 | | |
| TP30 | TP05 | | |
| TP07 | TP02 | | |
| TP05 | TP01 | | |
| TP02 | TP00 | | |
| TP01 | | | |
| TP00 | | | |

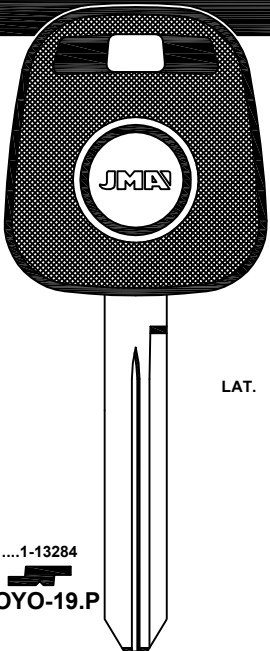
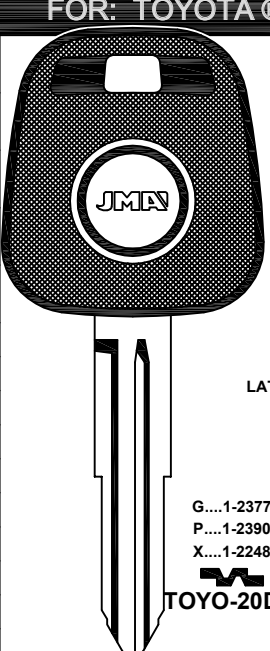
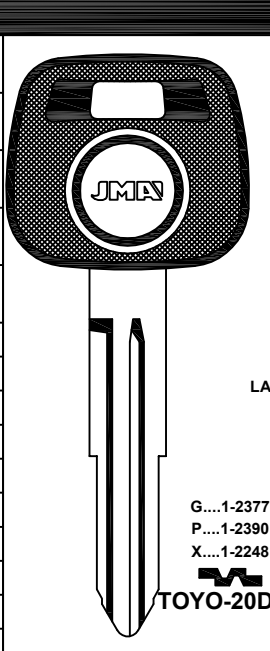

FOR: TOYOTA®

| | | |
|---|--|--|
| 1-13284 TOYO-19.P |  G....1-2377 P....1-2390 X....1-2248 TOYO-20D.P |  G....1-2377 P....1-2390 X....1-2248 TOYO-20D.P1 |
| LAT. | LAT. | LAT. |
| | TPG1 | |
| | TPX6 | TPX6 |
| | TPX5 | TPX5 |
| | TPX2 | TPX2 |
| | TPX1 | TPX1 |
| | TP35 | TP30 |
| | TP19 | TP07 |
| | TP07 | TP00 |
| | TP00 | TP00 |

FOR:
TOYOTA®
TRW-SIPEA®

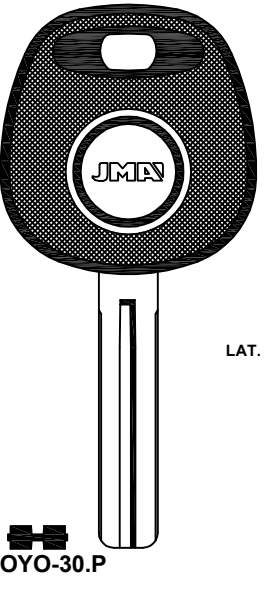
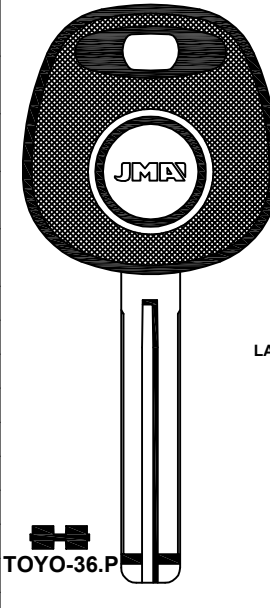
| | |
|--|--|
| FOR: TOYOTA® | FOR: TRW-SIPEA® |
|  TOYO-30.P |  TOYO-36.P |
| LAT. | LAT. |
| | TPX6 |
| | TPX5 |
| | TPX2 |
| | TPX1 |
| | TP30 |
| | TP29 |
| | TP07 |
| | TP00 |

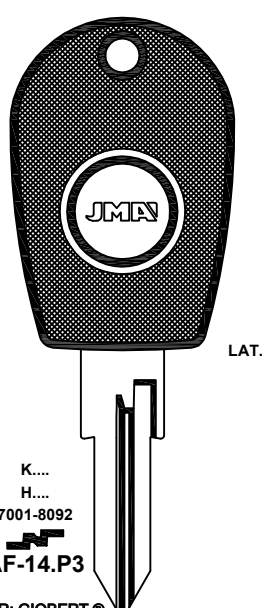
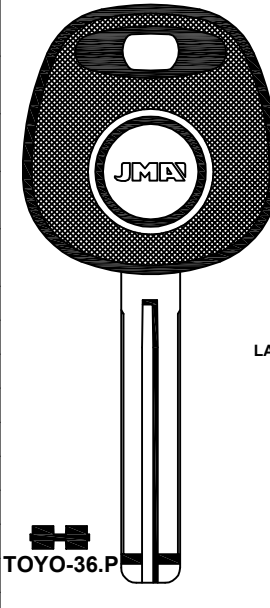



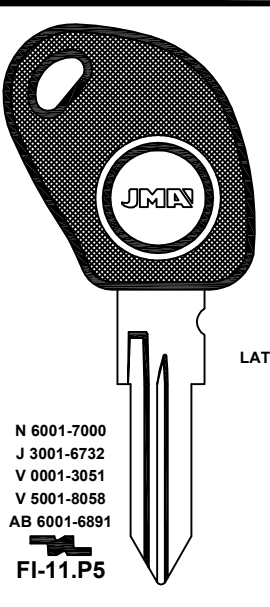
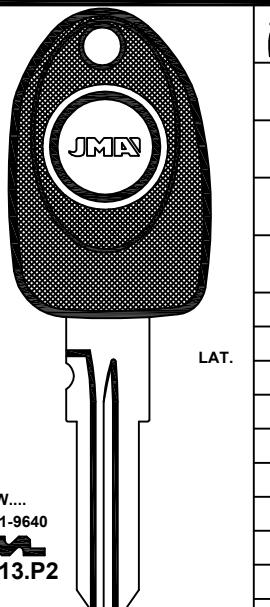
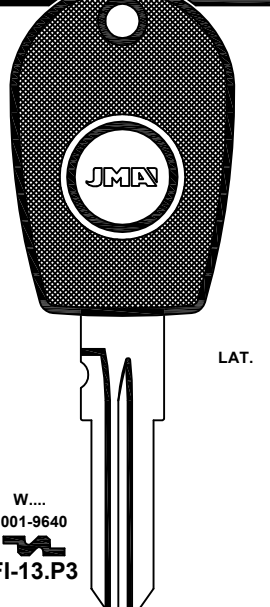

| | |
|---|--|
|  K.... H.... 7001-8092 AF-14.P3 |  TOYO-36.P |
| LAT. | LAT. |
| | TPX6 |
| | TPX5 |
| | TPX2 |
| | TPX1 |
| | TP29 |
| | TP07 |
| | TP00 |



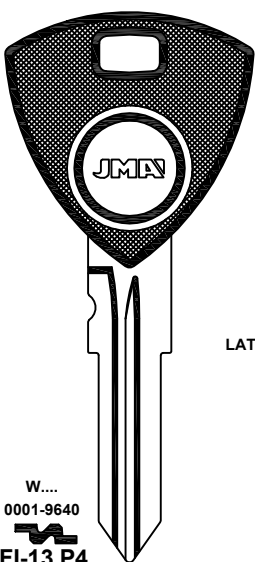

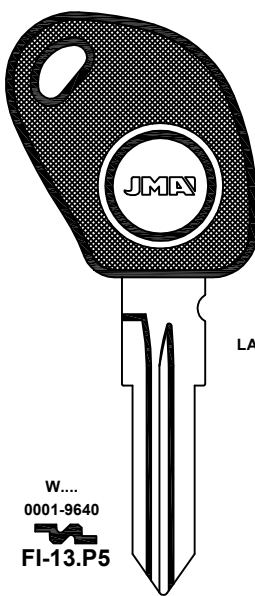

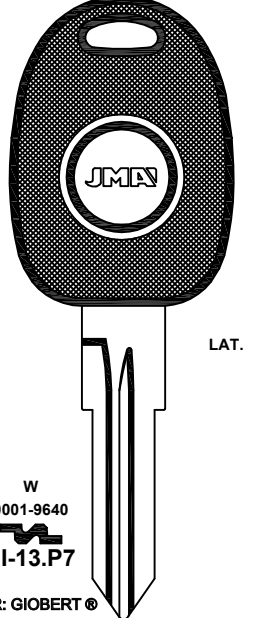

FOR: TRW-SIPEA®

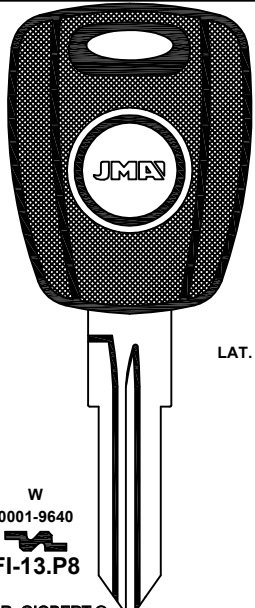

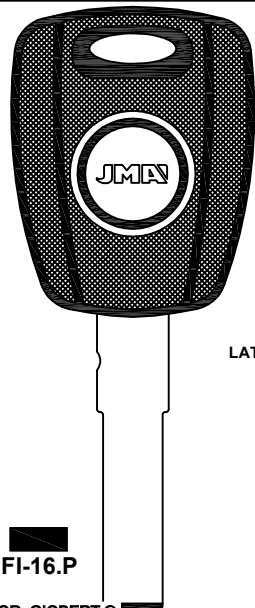

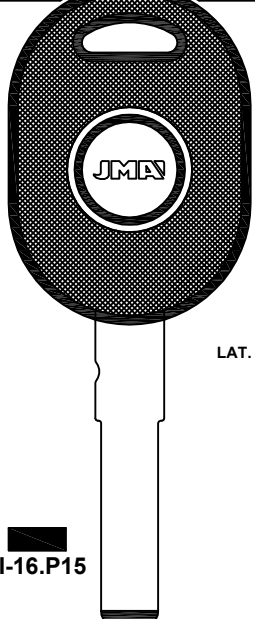

| | | |
|--|--|---|
|  N 6001-7000 J 3001-6732 V 0001-3051 V 5001-8058 AB 6001-6891 FI-11.P5 |  W.... 0001-9640 FI-13.P2 |  W.... 0001-9640 FI-13.P3 |
| LAT. | LAT. | LAT. |
| | TPX8+ | |
| | TPX8 | |
| | TPX5 | |
| | TPX4 | |
| | TP12 | |
| | TP05 | TP05 |
| | TP04 | TP03 |
| | TP03 | TP01 |
| | TP01 | TP00 |
| | TP00 | TP00 |

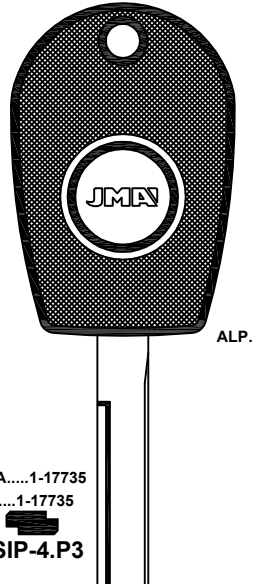

FOR:
TRW-SIPEA ®
USHIN ®

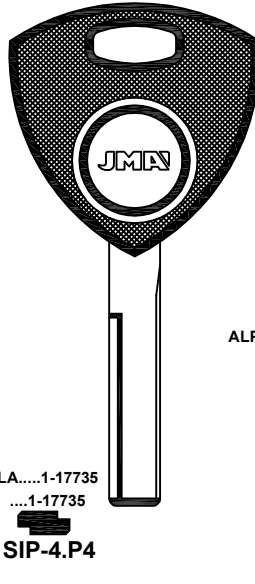
| FOR: TRW-SIPEA ® | | | | | | | | | |
|---|---|---|--|---|---|------|-------|------|-------|
|  <p>LAT.</p> <p>W.... 0001-9640 FI-13.P4</p> <p>FOR: GIObERT ®</p> |  |  <p>LAT.</p> <p>W.... 0001-9640 FI-13.P5</p> <p>FOR: GIObERT ®</p> |  |  <p>LAT.</p> <p>W 0001-9640 FI-13.P7</p> <p>FOR: GIObERT ®</p> |  | | | | |
| | | | | | | TP05 | TPX8+ | TP08 | TPX8+ |
| | | | | | | TP04 | TPX8 | TP05 | TPX8 |
| | | | | | | TP03 | TP08 | TP03 | TP08 |
| | | | | | | TP00 | TP05 | TP00 | TP05 |
| | | | | | | | TP03 | | TP03 |

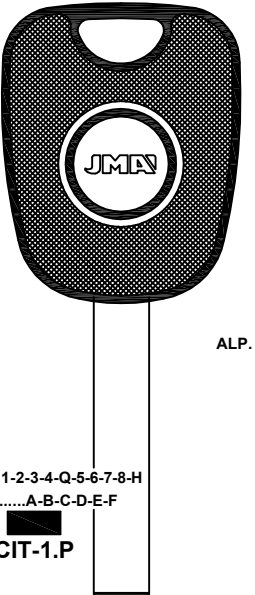
| FOR: TRW-SIPEA ® | | | | | | | | |
|--|---|---|--|---|---|-------|-------|-------|
|  <p>LAT.</p> <p>W 0001-9640 FI-13.P8</p> <p>FOR: GIObERT ®</p> |  |  <p>LAT.</p> <p>FI-16.P</p> <p>FOR: GIObERT ®</p> |    |  <p>LAT.</p> <p>FI-16.P15</p> |  | | | |
| | | | | | | TPX8+ | TPX8+ | TPX8+ |
| | | | | | | TPX8 | TPX8 | TPX8 |
| | | | | | | TP08 | TPX6 | TP08 |
| | | | | | | TP05 | TPX5 | TP05 |
| | | | | | | TP04 | TPX4 | TP04 |
| TP03 | TP12 | TP03 | | | | | | |
| TP01 | TP08 | TP01 | | | | | | |
| TP00 | TP05 | TP00 | | | | | | |
| | TP00 | | | | | | | |

| FOR: TRW-SIPEA ® | | | FOR: USHIN ® | | | | |
|--|---|--|--|--|---|------|------|
|  <p>ALP.</p> <p>LA.....1-177351-17735 SIP-4.P3</p> <p>FOR: GIObERT ®</p> |  |  <p>ALP.</p> <p>LA.....1-177351-17735 SIP-4.P4</p> <p>FOR: GIObERT ®</p> |  |  <p>ALP.</p> <p>.....1-2-3-4-Q-5-6-7-8-HA-B-C-D-E-F CIT-1.P</p> |  | | |
| | | | | | | TPX5 | TPX6 |
| | | | | | | TPX4 | TPX5 |
| | | | | | | TP12 | TPX4 |
| | | | | | | TP05 | TPX2 |
| | | | | | | TP01 | TP35 |
| TP00 | TP12RN | | | | | | |
| | TP12NS | | | | | | |
| | TP12 | | | | | | |
| | TP00 | | | | | | |



| FOR: VACHETTE® | | FOR: YAMAHA® | | FOR: YMOS® | |
|--|---|--|---|---|---|
| | | | | | |
| <p>....A/Z 0/9 1-4092A/Z 0/9 5001-9092A/Z 0/9 1-4092A/Z 0/9 5001-9092</p> <p></p> <p>VA-34.P4</p> | <p>LAT.</p> <p>TPX5 TPX4 TP12RN TP12NS TP05 TP01 TP00</p> | <p>LAT.</p> <p>B....7001-8000 C....7001-8000 A....7001-8500</p> <p></p> <p>YAMA-26D.P2</p> | <p>LAT.</p> <p>TPX6 TPX5 TPX2 TP31 TP00</p> | <p>HM 0001-1200 2501-3500 4001-5795 5801-7350 NF 0001-1200 ..NF.. 1-99/1-99</p> <p></p> <p>ME-HM.P1</p> | <p>LAT.</p> <p>TP05 TP04 TP03 TP01 TP00</p> |
| FOR: YMOS® | | FOR: ZADI® | | | |
| | | | | | |
| <p>HM 0001-1200 2501-3500 4001-5795 5801-7350 NF 0001-1200 ..NF.. 1-99/1-99</p> <p></p> <p>ME-HM.TL</p> | <p>LAT.</p> <p>TP00</p> | <p>LAT.</p> <p>W.... 0001-9640</p> <p></p> <p>FI-13.P6</p> | <p>LAT.</p> <p>TP05 TP00</p> | <p>LAT.</p> <p>8001-9554</p> <p></p> <p>ZA-9.P</p> | <p>TPX6 TPX5 TPX2 TP31 TP05 TP03 TP00</p> |
| FOR: ZADI® | | | | | |
| | | | | | |
| <p>8001-9554 ...1-700 N...1-700 ...1-700</p> <p></p> <p>ZA-11.P</p> | <p>LAT.</p> <p>TPX6 TPX5 TPX4 TPX2 TP31 TP12HN TP05 TP03 TP00</p> | <p>LAT.</p> <p></p> <p>ZA-14.P</p> | <p>LAT.</p> <p>TP05 TP00</p> | | |

FOR:
VACHETTE®
YAMAHA®
YMOS®
ZADI®









KRC
TELEMANDOS
REMOTES

GUÍA TELEMANDOS KRC

KRC REMOTES GUIDE



EUROPE



| FOR: |  | FROM | TO |  | REMOTE |
|------------|---|------|-----------|--|--------|
| AUDI® | A1 | 2010 | 2019 | KRCHU-HAA | KRC100 |
| | A3 | 1997 | 2003 | KRCHU-HAA | KRC100 |
| | A3 | 2003 | 2012 | KRCHU-HAA | KRC100 |
| | A4 | 1999 | 2001 | KRCHU-HAA | KRC100 |
| | A6 | 1998 | 2004 | KRCHU-HAA | KRC100 |
| | A8 | 1997 | 2003 | KRCHU-HAA | KRC100 |
| | Q3 | 2010 | 2019 | KRCHU-HAA | KRC100 |
| | S1 | 2010 | 2019 | KRCHU-HAA | KRC100 |
| | TT | 1999 | 2002 | KRCHU-HAA | KRC100 |
| | TT | 2002 | 2006 | KRCHU-HAA | KRC100 |
| | TT | 2002 | 2005 | KRCHU-HAA | KRC100 |
| TT | 2007 | 2013 | KRCHU-HAA | KRC100 | |
| CHEVROLET® | AVEO | 2011 | | KRCOP-11 | KRC200 |
| | Captiva | 2006 | 2011 | KRCDAE-4 | KRC100 |
| | Cruze | 2008 | 2014 | KRCOP-11 | KRC200 |
| | Orlando | 2011 | 2015 | KRCOP-11 | KRC200 |
| | Spark | 2015 | | KRCOP-11 | KRC200 |
| CHRYSLER® | PT Cruiser | 2001 | 2005 | KRCCHR-15 | KRC100 |
| CITROEN® | Berlingo | 2009 | 2016 | KRCCIT-1 | KRC200 |
| | C2 | 2005 | 2009 | KRCCIT-1 | KRC200 |
| | C3 | 2005 | 2009 | KRCCIT-1 | KRC200 |
| | C3 | 2009 | 2016 | KRCCIT-1 | KRC200 |
| | C3 PICASSO | 2008 | 2017 | KRCCIT-1 | KRC200 |
| | C4 | 2004 | 2010 | KRCCIT-1 | KRC200 |
| | C4 | 2010 | 2016 | KRCCIT-1 | KRC200 |
| | C4 Picasso | 2006 | 2013 | KRCHU-HCA | KRC200 |
| | C4 Picasso | 2007 | 2010 | KRCHU-HCA | KRC200 |
| | C4 Picasso | 2010 | | | KRC200 |
| | C4/C5/C6/C4 Picasso | 2005 | 2009 | KRCCIT-1 | KRC200 |
| | C5 | 2007 | 2010 | KRCHU-HCA | KRC200 |
| | C6 | 2004 | 2010 | KRCCIT-1 | KRC200 |
| | C8 | 2005 | 2009 | KRCHU-HCA | KRC200 |
| | C8 | 2009 | 2014 | KRCHU-HCA | KRC200 |
| | DISPATCH | 2005 | 2009 | KRCCIT-1 | KRC200 |
| | DISPATCH | 2009 | 2014 | KRCHU-HCA | KRC200 |
| | Jumpy | 2006 | 2009 | KRCHU-HCA | KRC200 |
| | Jumpy | 2009 | 2016 | KRCHU-HCA | KRC200 |
| Partner | 2009 | 2016 | KRCCIT-1 | KRC200 | |
| DS® | DS3 | 2009 | 2016 | KRCCIT-1 | KRC200 |
| | DS4 | 2011 | 2015 | KRCCIT-1 | KRC200 |
| FIAT® | SCUDO | 2007 | 2009 | KRCHU-HCA | KRC200 |
| | SCUDO | 2009 | 2016 | KRCHU-HCA | KRC200 |
| | ULYSSE | 2005 | 2009 | KRCHU-HCA | KRC200 |
| | ULYSSE | 2009 | 2011 | KRCHU-HCA | KRC200 |

| FOR: |  | FROM | TO |  | REMOTE |
|----------------------------|---|------|-----------|--|--------|
| FORD[®] | B-MAX | 2012 | | KRCFO-24 | KRC100 |
| | C-Max | 2003 | 2007 | KRCFO-24 | KRC100 |
| | C-Max | 2007 | 2010 | KRCFO-24 | KRC100 |
| | C-Max | 2011 | | KRCFO-24 | KRC100 |
| | Cougar | 1998 | 2000 | KRCFO-6 | KRC100 |
| | ECOSPORT | 2013 | 2018 | KRCFO-24 | KRC100 |
| | Fiesta | 1995 | 2008 | KRCFO-6 | KRC100 |
| | Fiesta | 2008 | 2017 | KRCFO-24 | KRC100 |
| | Focus | 1998 | 2005 | KRCFO-6 | KRC100 |
| | Focus | 2004 | 2011 | KRCFO-24 | KRC100 |
| | Focus | 2011 | | KRCFO-24 | KRC100 |
| | Fusion | 2002 | 2012 | KRCFO-6 | KRC100 |
| | Galaxy | 2006 | 2014 | KRCFO-24 | KRC100 |
| | Ka | 2000 | 2008 | KRCFO-6 | KRC100 |
| | KUGA | 2008 | 2015 | KRCFO-24 | KRC100 |
| | Mondeo | 1998 | 2007 | KRCFO-6 | KRC100 |
| | Mondeo | 2007 | 2011 | KRCFO-24 | KRC100 |
| | Mondeo | 2011 | 2014 | KRCFO-24 | KRC100 |
| | PUMA | 1998 | 2002 | KRCFO-6 | KRC100 |
| | Ranger | 2011 | 2015 | KRCFO-24 | KRC100 |
| S Max | 2006 | 2010 | KRCFO-24 | KRC100 | |
| S Max | 2010 | 2014 | KRCFO-24 | KRC100 | |
| S Max | 2011 | 2015 | KRCFO-24 | KRC300 | |
| Transit | 1995 | 2006 | KRCFO-6 | KRC100 | |
| Transit Connect | 2002 | 2013 | KRCFO-6 | KRC100 | |
| HOLDEN[®] | Astra | 1998 | 2004 | KRCOP-S | KRC100 |
| HONDA[®] | Accord | 2008 | 2012 | KRCHON-31 | KRC200 |
| | Civic | 2002 | 2005 | KRCHON-31 | KRC100 |
| | Civic | 2003 | 2004 | KRCHON-31 | KRC100 |
| | Civic | 2006 | 2011 | KRCHON-31 | KRC100 |
| | Civic | 2012 | 2014 | KRCHON-31 | KRC200 |
| | Civic | 2014 | 2016 | KRCHON-31 | KRC200 |
| | CR-V | 2012 | 2013 | KRCHON-31 | KRC200 |
| | CR-V | 2014 | 2016 | KRCHON-31 | KRC200 |
| | FRV | 2007 | 2009 | KRCHON-31 | KRC100 |
| | Jazz | 2001 | 2003 | KRCHON-31 | KRC100 |
| | Jazz | 2006 | 2008 | KRCHON-31 | KRC100 |
| Jazz | 2013 | | KRCHON-31 | KRC200 | |
| HYUNDAI[®] | Elantra | 2000 | 2006 | KRCHY-4 | KRC100 |
| | Grand Starex | 2007 | 2015 | KRCHY-11 | KRC100 |
| | H1 | 2007 | 2015 | KRCHY-11 | KRC100 |
| | H1-BUS | 2007 | 2015 | KRCHY-11 | KRC100 |
| | I10 Europe | 2008 | 2013 | KRCHY-11 | KRC100 |
| | I10 Europe | 2014 | | KRCKI-7 | KRC100 |
| | I20 | 2008 | 2012 | KRCTOYO-18 | KRC100 |
| | I30 | 2007 | 2011 | KRCKI-7 | KRC100 |
| | I30 | 2012 | 2016 | KRCKI-7 | KRC100 |
| | IX35 | 2011 | | KRCKI-7 | KRC100 |
| | Matrix | 2001 | 2006 | KRCHY-4 | KRC100 |
| | Santa Fe | 2001 | 2006 | KRCHY-4 | KRC100 |

GUÍA TELEMANDOS KRC



KRC REMOTES GUIDE



| FOR: |  | FROM | TO |  | REMOTE |
|-------------|---|------|------|--|--------|
| HYUNDAI® | TERRACAN | 2001 | 2007 | KRCHY-4 | KRC100 |
| | TRAJET | 2000 | 2007 | KRCHY-6D | KRC100 |
| JAGUAR® | S-Type | 1999 | 2009 | KRCFO-6 | KRC100 |
| | XJ | 2002 | 2009 | KRCFO-6 | KRC100 |
| | X-Type | 2001 | 2009 | KRCFO-6 | KRC100 |
| KIA® | Ceed | 2006 | 2012 | KRCKI-7 | KRC100 |
| | Rio | 2012 | 2014 | KRCKI-7 | KRC100 |
| | Sportage | 2010 | 2014 | KRCKI-7 | KRC100 |
| | Sportage | 2014 | 2016 | KRCKI-7 | KRC100 |
| LANCIA® | Phedra | 2006 | 2010 | KRCHU-HCA | KRC200 |
| LEXUS® | GS300 | 2000 | 2004 | KRCTOYO-30 | KRC100 |
| | GS430 | 2001 | 2005 | KRCTOYO-30 | KRC100 |
| | IS200 | 1999 | 2005 | KRCTOYO-30 | KRC100 |
| | IS300 | 2001 | 2005 | KRCTOYO-30 | KRC100 |
| | RX300 | 1999 | 2003 | KRCTOYO-30 | KRC100 |
| MAZDA® | 2 | 2002 | 2006 | KRCMAZ-11D | KRC100 |
| | 2 | 2007 | 2014 | KRCMAZ-11D | KRC100 |
| | 2 | 2007 | 2010 | KRCMAZ-11D | KRC100 |
| | 3 | 2004 | 2008 | KRCMAZ-11D | KRC100 |
| | 3 | 2008 | 2011 | KRCMAZ-11D | KRC100 |
| | 3 | 2012 | 2013 | KRCMAZ-11D | KRC100 |
| | 6 | 2002 | 2004 | KRCMAZ-11D | KRC100 |
| | 6 | 2004 | 2008 | KRCMAZ-11D | KRC100 |
| | 6 | 2008 | 2012 | KRCMAZ-11D | KRC100 |
| | BT50 | 2011 | 2015 | KRCFO-24 | KRC100 |
| | CX7 | 2006 | 2012 | KRCMAZ-11D | KRC100 |
| | CX9 | 2007 | 2009 | KRCMAZ-11D | KRC100 |
| | M5 | 2005 | 2010 | KRCMAZ-11D | KRC100 |
| | M5 | 2010 | 2015 | KRCMAZ-11D | KRC100 |
| | MX-5 | 2005 | 2012 | KRCMAZ-11D | KRC100 |
| MITSUBISHI® | Colt | 2005 | 2010 | KRCMIT-8D | KRC100 |
| | Grandis | 2003 | 2011 | KRCMIT-8D | KRC100 |
| | L200 | 2006 | 2011 | KRCMIT-12 | KRC100 |
| | Lancer | 2006 | 2010 | KRCMIT-8D | KRC100 |
| | Montero | 2006 | 2014 | KRCMIT-12 | KRC100 |
| | Montero Sport | 2008 | 2014 | KRCMIT-12 | KRC100 |
| | Pajero | 2006 | 2014 | KRCMIT-12 | KRC100 |
| | Pajero | 2006 | 2011 | KRCMIT-12 | KRC100 |
| | Pajero | 2008 | 2014 | KRCMIT-7 | KRC100 |
| NISSAN® | Juke | 2010 | 2014 | KRCDAT-15 | KRC100 |
| | KING CAB | 2008 | 2011 | KRCDAT-15 | KRC100 |
| | Micra | 2010 | 2014 | KRCDAT-15 | KRC100 |
| OPEL® | Adam | 2013 | 2016 | KRCOP-11 | KRC200 |
| | Antara | | 2012 | KRCDAE-4 | KRC100 |
| | Astra | 1998 | 2004 | KRCOP-S | KRC100 |
| | Astra | 2009 | 2015 | KRCOP-11 | KRC200 |
| | Cascada | 2013 | 2017 | KRCOP-11 | KRC200 |
| | INSIGNIA | 2008 | 2017 | KRCOP-11 | KRC200 |
| | Mokka | 2012 | | KRCOP-11 | KRC200 |
| | Zafira | 2001 | 2005 | KRCOP-S | KRC100 |

| FOR: |  | FROM | TO |  | REMOTE |
|----------------------------|---|------|------|--|--------|
| OPEL[®] | Zafira | 2013 | | KRCOP-11 | KRC200 |
| PEUGEOT[®] | 207 | 2006 | 2012 | KRCHU-HCA | KRC200 |
| | 208 | 2012 | 2018 | KRCHU-HCA | KRC200 |
| | 301 | 2013 | 2016 | KRCHU-HCA | KRC200 |
| | 301 | 2014 | 2016 | KRCHU-HCA | KRC200 |
| | 307 | 2005 | 2007 | KRCHU-HCA | KRC200 |
| | 308 | 2009 | 2016 | KRCHU-HCA | KRC200 |
| | 308 | 2011 | | KRCHU-HCA | KRC200 |
| | 407 | 2004 | 2008 | KRCCIT-1 | KRC200 |
| | 508 | 2010 | 2014 | KRCCIT-1 | KRC200 |
| | 807 | 2005 | 2009 | KRCHU-HCA | KRC200 |
| | 807 | 2009 | 2014 | KRCHU-HCA | KRC200 |
| | 2008 | 2012 | 2016 | KRCHU-HAA | KRC200 |
| | 3008 | 2009 | 2016 | KRCHU-HCA | KRC200 |
| | 5008 | 2009 | 2016 | KRCHU-HCA | KRC200 |
| | Expert | 2007 | 2009 | KRCHU-HCA | KRC200 |
| | Expert | 2009 | | KRCHU-HCA | KRC200 |
| | Partner | 2008 | 2013 | KRCCIT-1 | KRC200 |
| RENAULT[®] | Clio II | 2001 | 2008 | KRCNE-36 | KRC200 |
| | Clio III | 2006 | 2010 | KRCCIT-1 | KRC200 |
| | Modus | 2004 | 2012 | KRCCIT-1 | KRC200 |
| SEAT[®] | ALHAMBRA | 2011 | 2013 | KRCHU-HAA | KRC100 |
| | Altea | 2004 | 2008 | KRCHU-HAA | KRC100 |
| | Altea | 2009 | 2010 | KRCHU-HAA | KRC100 |
| | Altea | 2011 | 2013 | KRCHU-HAA | KRC100 |
| | CORDOBA | 2003 | 2009 | KRCHU-HAA | KRC100 |
| | Ibiza | 2002 | 2010 | KRCHU-HAA | KRC100 |
| | Ibiza | 2008 | 2011 | KRCHU-HAA | KRC100 |
| | Leon | 2000 | 2002 | KRCHU-HAA | KRC100 |
| | Leon | 2002 | 2005 | KRCHU-HAA | KRC100 |
| | Leon | 2005 | 2008 | KRCHU-HAA | KRC100 |
| | Leon | 2006 | 2013 | KRCHU-HAA | KRC100 |
| | Leon | 2006 | 2010 | KRCHU-HAA | KRC100 |
| | MII | 2012 | 2013 | KRCHU-HAA | KRC100 |
| | Toledo | 1999 | 2001 | KRCHU-HAA | KRC100 |
| | Toledo | 2002 | 2004 | KRCHU-HAA | KRC100 |
| | Toledo | 2005 | 2009 | KRCHU-HAA | KRC100 |
| | Toledo | 2009 | 2010 | KRCHU-HAA | KRC100 |
| SKODA[®] | Fabia | 2000 | 2008 | KRCHU-HAA | KRC100 |
| | Fabia | 2007 | 2010 | KRCHU-HAA | KRC100 |
| | Fabia | 2011 | 2013 | KRCHU-HAA | KRC100 |
| | GITIGO | 2012 | 2013 | KRCHU-HAA | KRC100 |
| | Octavia | 1997 | 2001 | KRCHU-HAA | KRC100 |
| | Octavia | 2004 | 2008 | KRCHU-HAA | KRC100 |
| | Octavia | 2004 | 2010 | KRCHU-HAA | KRC100 |
| | Octavia | 2009 | 2012 | KRCHU-HAA | KRC100 |
| | Octavia I | 1998 | 1998 | KRCHU-HAA | KRC100 |
| | RAPID | 2012 | 2013 | KRCHU-HAA | KRC100 |
| | Roomster | 2006 | 2010 | KRCHU-HAA | KRC100 |
| | Superb | 2002 | 2008 | KRCHU-HAA | KRC100 |
| | Superb | 2008 | 2013 | KRCHU-HAA | KRC100 |

GUÍA TELEMANDOS KRC

KRC REMOTES GUIDE



| FOR: |  | FROM | TO |  | REMOTE |
|---------|---|------|------------|---|--------|
| SKODA® | Superb | 2009 | 2013 | KRCHU-HAA | KRC100 |
| | Yeti | 2010 | 2013 | KRCHU-HAA | KRC100 |
| SMART® | Fortwo | 2005 | 2015 | KRCCIT-1 | KRC200 |
| SUBARU® | Forester | 2008 | 2012 | KRCSUB-2 | KRC100 |
| | Legacy | 2009 | 2013 | KRCSUB-2 | KRC100 |
| SUZUKI® | Grand Vitara | 2008 | 2013 | KRCSUZU-14 | KRC100 |
| | Splash | 2008 | 2015 | KRCSUZU-14 | KRC200 |
| | Swift | 2005 | 2010 | KRCSUZU-14 | KRC200 |
| | SX4 | 2006 | 2012 | KRCSUZU-14 | KRC100 |
| | SX4 | 2006 | 2012 | KRCSUZU-14 | KRC100 |
| TOYOTA® | Avensis | 2012 | 2014 | | KRC100 |
| | AVENSIS VERSO | 2001 | 2003 | KRCTOYO-15 | KRC100 |
| | AVENSIS VERSO | 2004 | 2009 | KRCTOYO-15 | KRC100 |
| | Camry | 2002 | 2005 | KRCTOYO-15 | KRC100 |
| | COROLLA | 2001 | 2007 | KRCTOYO-15 | KRC100 |
| | COROLLA VERSO | 2001 | 2004 | KRCTOYO-15 | KRC100 |
| | FJ Cruiser | 2007 | 2007 | KRCTOYO-15 | KRC100 |
| | HIACE | 2003 | 2007 | KRCTOYO-15 | KRC100 |
| | Land Cruiser | 1998 | 2007 | KRCTOYO-15 | KRC100 |
| | Land Cruiser | 2000 | 2002 | KRCTOYO-15 | KRC100 |
| | Land Cruiser | 2002 | 2010 | KRCTOYO-15 | KRC100 |
| | Land Cruiser | 2005 | 2007 | KRCTOYO-15 | KRC100 |
| | PICNIC | 2001 | 2003 | KRCTOYO-15 | KRC100 |
| | PICNIC | 2003 | 2008 | KRCTOYO-15 | KRC100 |
| | Previa | 2002 | 2005 | KRCTOYO-15 | KRC100 |
| | Previa | 2003 | 2008 | KRCTOYO-15 | KRC100 |
| | PROACE | 2013 | 2016 | KRCHU-HCA | KRC200 |
| | RAV4 | 2000 | 2005 | KRCTOYO-15 | KRC100 |
| | RAV4 | 2003 | 2005 | KRCTOYO-15 | KRC100 |
| | Verso Europe | 2009 | | KRCTOYO-15 | KRC100 |
| Wish | 2004 | 2009 | KRCTOYO-15 | KRC100 | |
| VW® | AMAROK | 2011 | 2015 | KRCHU-HAA | KRC100 |
| | Beetle | 1999 | 2003 | KRCHU-HAA | KRC100 |
| | Beetle | 2002 | 2005 | KRCHU-HAA | KRC100 |
| | Beetle | 2005 | 2010 | KRCHU-HAA | KRC100 |
| | Beetle | 2012 | 2013 | KRCHU-HAA | KRC100 |
| | BORA | 1998 | 2000 | KRCHU-HAA | KRC100 |
| | BORA | 1999 | 2001 | KRCHU-HAA | KRC100 |
| | BORA | 2002 | 2005 | KRCHU-HAA | KRC100 |
| | BORA | 2011 | 2013 | KRCHU-HAA | KRC100 |
| | Caddy | 2004 | 2011 | KRCHU-HAA | KRC100 |
| | Caddy | 2010 | | KRCHU-HAA | KRC100 |
| | Caddy | 2011 | 2013 | KRCHU-HAA | KRC100 |
| | Crafter | 2006 | 2013 | KRCME-7 | KRC100 |
| | EOS | 2006 | 2011 | KRCHU-HAA | KRC100 |
| | EOS | 2009 | 2013 | KRCHU-HAA | KRC100 |
| | GOL | 2010 | 2013 | KRCHU-HAA | KRC100 |
| | Golf | 1998 | 2001 | KRCHU-HAA | KRC100 |
| | Golf | 2002 | 2004 | KRCHU-HAA | KRC100 |



| FOR: |  | FROM | TO |  | REMOTE |
|-----------------|---|------|-----------|--|--------|
| VW [®] | Golf | 2004 | 2009 | KRCHU-HAA | KRC100 |
| | Golf | 2009 | 2011 | KRCHU-HAA | KRC100 |
| | Golf | 2011 | 2013 | KRCHU-HAA | KRC300 |
| | GOLF PLUS | 2005 | 2009 | KRCHU-HAA | KRC100 |
| | GOLF PLUS | 2009 | 2011 | KRCHU-HAA | KRC100 |
| | GOLF PLUS | 2011 | 2013 | KRCHU-HAA | KRC100 |
| | LAVIDA | 2011 | 2016 | KRCHU-HAA | KRC300 |
| | MPV Transporter | 2004 | 2010 | KRCHU-HAA | KRC100 |
| | MPV Transporter | 2010 | 2014 | KRCHU-HAA | KRC100 |
| | MPV Transporter | 2012 | | KRCHU-HAA | KRC100 |
| | NOUVELLE COCCINELLE | 2012 | 2013 | KRCHU-HAA | KRC100 |
| | PASSAT | 1997 | 2000 | KRCHU-HAA | KRC100 |
| | PASSAT | 2001 | 2005 | KRCHU-HAA | KRC100 |
| | PASSAT | 2011 | 2016 | KRCHU-HAA | KRC300 |
| | Polo | 2002 | 2009 | KRCHU-HAA | KRC100 |
| | Polo | 2009 | 2010 | KRCHU-HAA | KRC100 |
| | Polo | 2010 | 2013 | KRCHU-HAA | KRC100 |
| | Sagitar | 2011 | 2017 | KRCHU-HAA | KRC300 |
| | Scirocco | 2009 | 2010 | KRCHU-HAA | KRC100 |
| | Scirocco | 2011 | 2013 | KRCHU-HAA | KRC100 |
| | Sharan | 2011 | | KRCHU-HAA | KRC100 |
| | Sharan | 2011 | 2013 | KRCHU-HAA | KRC100 |
| | TIGUAN | 2008 | 2011 | KRCHU-HAA | KRC100 |
| | TIGUAN | 2010 | 2013 | KRCHU-HAA | KRC100 |
| | TIGUAN | 2011 | 2016 | KRCHU-HAA | KRC300 |
| | TIGUAN | 2012 | | KRCHU-HAA | KRC100 |
| Touran | 2003 | 2010 | KRCHU-HAA | KRC100 | |
| Touran | 2010 | 2014 | KRCHU-HAA | KRC100 | |
| UP | 2012 | | KRCHU-HAA | KRC100 | |

GUÍA TELEMANDOS KRC

KRC REMOTES GUIDE



USA



| FOR: |  | FROM | TO |  | REMOTE |
|------------|---|------|----------|--|--------|
| ACURA® | TL | 2009 | 2014 | KRCHON-31 | KRC100 |
| | TSX | 2009 | 2010 | KRCHON-31 | KRC100 |
| | TSX | 2011 | 2014 | KRCHON-31 | KRC100 |
| AUDI® | A1 | 2015 | 2019 | | KRC300 |
| | A3 | 2005 | 2013 | KRCHU-HAA | KRC100 |
| | A4 | 1997 | 2005 | KRCHU-HAA | KRC100 |
| | A4 | 1998 | 2002 | KRCHU-HAA | KRC100 |
| | A6 | 1997 | 2000 | KRCHU-HAA | KRC100 |
| | A6 | 1998 | 2004 | KRCHU-HAA | KRC100 |
| | A6 | 2001 | 2005 | KRCHU-HAA | KRC100 |
| | A8 | 1997 | 2005 | KRCHU-HAA | KRC100 |
| | A8 | 1997 | 2003 | KRCHU-HAA | KRC100 |
| | Allroad | 2001 | 2005 | KRCHU-HAA | KRC100 |
| | Q3 | 2015 | 2019 | KRCHU-HAA | KRC300 |
| | S4 | 2000 | 2005 | KRCHU-HAA | KRC100 |
| | TT | 2003 | 2006 | KRCHU-HAA | KRC100 |
| | TT | 2007 | 2013 | KRCHU-HAA | KRC100 |
| BUICK® | Allure | 2005 | 2009 | KRCGM-37 | KRC100 |
| | Allure | 2010 | 2012 | KRCOP-11 | KRC200 |
| | Century | 1997 | 2000 | | KRC100 |
| | Century | 2001 | 2005 | | KRC100 |
| | Enclave | 2008 | 2016 | KRCGM-37 | KRC100 |
| | Encore | 2014 | 2015 | KRCOP-11 | KRC200 |
| | Lesabre | 2001 | 2005 | KRCGM-28 | KRC100 |
| | Lucerne | 2006 | 2011 | KRCGM-37 | KRC100 |
| | New LaCrosse | 2005 | 2006 | KRCGM-37 | KRC100 |
| | New LaCrosse | 2007 | 2008 | KRCGM-37 | KRC100 |
| | New LaCrosse | 2010 | 2015 | KRCOP-11 | KRC200 |
| | Rainier | 2004 | 2007 | KRCGM-28 | KRC100 |
| | Regal | 1997 | 2000 | | KRC100 |
| | Regal | 2001 | 2004 | | KRC100 |
| | Regal | 2011 | 2015 | KRCOP-11 | KRC200 |
| | Rendezvous | 2002 | 2007 | KRCGM-28 | KRC100 |
| Terraza | 2005 | 2005 | KRCGM.27 | KRC100 | |
| Terraza | 2005 | 2006 | KRCGM.27 | KRC100 | |
| Verano | 2012 | 2015 | KRCOP-11 | KRC200 | |
| CADILLAC® | CTS | 2008 | 2013 | KRCGM-37 | KRC100 |
| | Deville | 2001 | 2005 | KRCGM-28 | KRC100 |
| | DTS | 2006 | 2007 | KRCGM-37 | KRC100 |
| | DTS | 2008 | 2011 | KRCGM-37 | KRC100 |
| | Eldorado | 2001 | 2002 | | KRC100 |
| | Escalade | 2002 | 2002 | | KRC100 |
| | Escalade | 2007 | 2013 | KRCGM-37 | KRC100 |
| | Seville | 2001 | 2004 | KRCGM-28 | KRC100 |
| | STS | 2001 | 2005 | KRCGM-28 | KRC100 |
| CHEVROLET® | [All remotes] | | | | KRC300 |
| | Astro | 2001 | 2006 | | KRC100 |
| | Avalanche | 2002 | 2002 | | KRC100 |

| FOR: |  | FROM | TO |  | REMOTE |
|------------------------------|---|------|-------------|--|--------|
| CHEVROLET[®] | Avalanche | 2007 | 2013 | KRCGM-37 | KRC100 |
| | Blazer | 2001 | 2005 | | KRC100 |
| | Camaro | 2010 | 2016 | KRCOP-11 | KRC200 |
| | Captiva Sport | 2012 | 2015 | KRCDAE-4 | KRC100 |
| | Cobalt | 2005 | 2005 | | KRC100 |
| | Cobalt | 2006 | 2011 | KRCGM-37 | KRC100 |
| | Colorado | 2004 | 2012 | KRCISU-3D | KRC100 |
| | Colorado | 2015 | 2016 | KRCOP-11 | KRC100 |
| | Corvette | 2001 | 2004 | | KRC100 |
| | Cruze | 2011 | 2015 | KRCOP-11 | KRC200 |
| | Equinox | 2007 | 2009 | KRCGM-37 | KRC100 |
| | Equinox | 2010 | 2015 | KRCOP-11 | KRC200 |
| | Explorer | | | | KRC300 |
| | Express | 2003 | 2007 | | KRC100 |
| | Express | 2008 | 2014 | KRCGM-37 | KRC100 |
| | Express | 2015 | 2016 | KRCOP-11 | KRC100 |
| | HHR | 2006 | 2011 | KRCGM-37 | KRC100 |
| | Impala | 2001 | 2005 | | KRC100 |
| | Impala | 2006 | 2013 | KRCGM-37 | KRC100 |
| | Impala | 2014 | 2014 | KRCOP-11 | KRC200 |
| | Malibu | 2001 | 2003 | | KRC100 |
| | Malibu | 2004 | 2005 | KRCGM-37 | KRC100 |
| | Malibu | 2004 | 2007 | KRCGM-37 | KRC100 |
| | Malibu | 2013 | 2016 | KRCOP-11 | KRC200 |
| | Monte Carlo | 2001 | 2005 | | KRC100 |
| | Monte Carlo | 2006 | 2007 | KRCGM-37 | KRC100 |
| | S10 | 2001 | 2004 | | KRC100 |
| | Silverado | 2001 | 2002 | | KRC100 |
| | Silverado | 2007 | 2013 | KRCGM-37 | KRC100 |
| | Silverado | 2014 | 2016 | KRCOP-11 | KRC100 |
| | Sonic | 2010 | 2016 | KRCOP-11 | KRC200 |
| | SSR | 2003 | 2006 | | KRC100 |
| | Suburban | 2001 | 2002 | | KRC100 |
| Suburban | 2007 | 2014 | KRCGM-37 | KRC100 | |
| Suburban | 2015 | 2016 | KRCOP-11 | KRC100 | |
| Tahoe | 2001 | 2002 | | KRC100 | |
| Tahoe | 2007 | 2014 | KRCGM-37 | KRC100 | |
| Tahoe | 2015 | 2016 | KRCOP-11 | KRC100 | |
| TrailBlazer | 2002 | 2009 | KRCGM-37 | KRC100 | |
| Traverse | 2009 | 2016 | KRCGM-37 | KRC100 | |
| Uplander | 2005 | 2009 | KRCGM-27/28 | KRC100 | |
| Venture | 1999 | 2000 | KRCGM-27 | KRC100 | |
| Venture | 2001 | 2005 | KRCGM-27 | KRC100 | |
| CHRYSLER[®] | 200 | 2011 | 2014 | KRCCHR-15 | KRC200 |
| | Pacifica | 2004 | 2008 | KRCCHR-15 | KRC200 |
| | PT Cruiser | 2006 | 2011 | KRCCHR-15 | KRC200 |
| | Sebring | 2007 | 2011 | KRCCHR-15 | KRC200 |
| | Sebring Coupe | 2002 | 2005 | KRCCHR-15 | KRC100 |
| DODGE[®] | Avenger | 2008 | 2014 | KRCCHR-15 | KRC200 |
| | Caliber | 2007 | 2012 | KRCCHR-15 | KRC200 |
| | Caravan | 2004 | 2007 | KRCCHR-15 | KRC200 |

GUÍA TELEMANDOS KRC



KRC REMOTES GUIDE



| FOR: |  | FROM | TO |  | REMOTE |
|---------------|---|------|---------------|--|--------|
| DODGE® | Nitro | 2007 | 2012 | KRCCHR-15 | KRC200 |
| | Stratus | 2002 | 2006 | KRCCHR-19 | KRC100 |
| FIAT® | 500X | 2017 | | | KRC300 |
| FORD® | Contour | 1995 | 2000 | KRCFO-16 | KRC100 |
| | Crown Victoria | 1995 | 2000 | KRCFO-15 | KRC100 |
| | Edge | 2007 | 2015 | KRCFO-15D/30D | KRC100 |
| | Escape | 2001 | 2016 | KRCFO-15D/30D/24 | KRC100 |
| | ESCAPE HYBRID | 2008 | 2012 | | KRC100 |
| | E-SERIES VAN | 2008 | 2012 | KRCFO-30D | KRC100 |
| | Excursion | 2000 | 2005 | KRCFO-15D | KRC100 |
| | Expedition | 1997 | 2016 | KRCFO-15D/30D | KRC100 |
| | Explorer | 1998 | 2015 | KRCFO-15D/30D/24 | KRC100 |
| | Explorer Sport Trac | 1999 | 2010 | KRCFO-30D | KRC100 |
| | F-150 | 1999 | 2014 | KRCFO-30D | KRC100 |
| | F-250 Super Duty | 1999 | 2016 | KRCFO-15D/30D | KRC100 |
| | F-350 Super Duty | 2008 | 2016 | KRCFO-30D | KRC100 |
| | F-450 Super Duty | 2011 | 2016 | KRCFO-30D | KRC100 |
| | F-550 Super Duty | 2011 | 2016 | KRCFO-30D | KRC100 |
| | Five Hundred | 2005 | 2007 | KRCFO-30D | KRC100 |
| | Focus | 2000 | 2015 | KRCFO-15D/30D/24 | KRC100 |
| | Freestar | 2004 | 2007 | KRCFO-30D | KRC100 |
| | Freestyle | 2005 | 2007 | KRCFO-30D | KRC100 |
| | GT | 2005 | 2006 | KRCFO-15D/30D | KRC100 |
| Mustang | 1996 | 2014 | KRCFO-15D/30D | KRC100 | |
| Ranger | 1999 | 2012 | KRCFO-30D | KRC100 | |
| Taurus | 1996 | 2016 | KRCFO-15D/30D | KRC100 | |
| Taurus X | 1998 | 1999 | KRCFO-15D | KRC100 | |
| Thunderbird | 1996 | 2005 | KRCFO-15D/30D | KRC100 | |
| Windstar | 1999 | 2003 | KRCFO-15D/30D | KRC100 | |
| GMC® | Acadia | 2007 | 2016 | KRCGM-37 | KRC100 |
| | Canyon | 2004 | 2012 | KRCISU-3D | KRC100 |
| | Canyon | 2015 | 2016 | KRCOP-11 | KRC100 |
| | Envoy | 2002 | 2009 | KRCGM-37 | KRC100 |
| | Jimmy | 2001 | 2004 | | KRC100 |
| | Safari | 2001 | 2005 | | KRC100 |
| | Savana | 2003 | 2007 | KRCGM-37 | KRC100 |
| | Savana | 2008 | 2019 | KRCGM-37 | KRC100 |
| | Sierra | 2001 | 2002 | | KRC100 |
| | Sierra | 2007 | 2013 | KRCGM-37 | KRC100 |
| | Sierra | 2015 | 2016 | KRCOP-11 | KRC100 |
| | Yukon | 2001 | 2002 | | KRC100 |
| | Yukon | 2007 | 2013 | KRCGM-37 | KRC100 |
| Yukon | 2015 | 2016 | KRCOP-11 | KRC100 | |
| HONDA® | Accord | 2003 | 2004 | KRCHON-31 | KRC100 |
| | Accord | 2003 | 2004 | KRCHON-21 | KRC100 |
| | Accord | 2005 | 2007 | KRCHON-31 | KRC100 |
| | Accord | 2008 | 2012 | KRCHON-31 | KRC100 |
| | Accord | 2013 | 2015 | | KRC200 |
| | Accord Crosstour | 2010 | 2012 | KRCHON-31 | KRC200 |
| | Civic | 2001 | 2002 | KRCHON-21 | KRC100 |
| | Civic | 2002 | 2005 | KRCHON-31 | KRC100 |
| | Civic | 2006 | 2011 | KRCHON-31 | KRC200 |

| FOR: |  | FROM | TO |  | REMOTE |
|-----------------------------|---|------|------|--|--------|
| HONDA[®] | Civic | 2014 | 2016 | | KRC200 |
| | CR-V | 2002 | 2004 | KRCHON-31 | KRC100 |
| | CR-V | 2005 | 2006 | KRCHON-31 | KRC100 |
| | CR-V | 2007 | 2013 | KRCHON-31 | KRC100 |
| | CR-V | 2012 | 2013 | KRCHON-31 | KRC200 |
| | CR-V | 2014 | 2016 | KRCHON-31 | KRC200 |
| | CR-Z | 2011 | 2015 | KRCHON-31 | KRC200 |
| | Fit | 2007 | 2008 | KRCHON-31 | KRC100 |
| | Fit | 2009 | 2013 | KRCHON-31 | KRC200 |
| | Insight | 2010 | 2014 | KRCHON-31 | KRC200 |
| | Jazz | 2006 | 2007 | KRCHON-31 | KRC100 |
| | Odyssey | 2005 | 2010 | KRCHON-31 | KRC200 |
| | Pilot | 2005 | 2015 | KRCHON-31 | KRC100 |
| | Ridgeline | 2006 | 2014 | KRCHON-31 | KRC100 |
| HUMMER[®] | H2 | 2003 | 2006 | | KRC100 |
| | H2 | 2008 | 2009 | KRCGM-37 | KRC100 |
| | H3 | 2006 | 2010 | KRCGM-37 | KRC100 |
| HYUNDAI[®] | Accent | 2012 | 2013 | | KRC100 |
| | Elantra | 2011 | 2015 | KRCHY-11 | KRC100 |
| | Sonata | 2011 | 2014 | KRCHY-11 | KRC100 |
| INFINITI[®] | FX35 | 2003 | 2008 | KRCDAT-15 | KRC100 |
| | FX45 | 2003 | 2008 | KRCDAT-15 | KRC100 |
| | G20 | 2000 | 2002 | KRCDAT-15 | KRC100 |
| | G35 | 2000 | 2002 | | KRC100 |
| | I30 | 2000 | 2001 | KRCDAT-15 | KRC100 |
| | I35 | 2002 | 2004 | KRCDAT-15 | KRC100 |
| | QX4 | 2000 | 2003 | KRCDAT-15 | KRC100 |
| | QX56 | 2004 | 2007 | KRCDAT-15 | KRC100 |
| ISUZU[®] | I-350 | 2006 | 2006 | KRCISU-3D | KRC100 |
| JAGUAR[®] | S-Type | 2000 | 2007 | KRCFO-6 | KRC100 |
| | XJ | 2004 | 2009 | KRCFO-6 | KRC100 |
| | X-Type | 2002 | 2007 | KRCFO-6 | KRC100 |
| JEEP[®] | Compass | 2007 | 2015 | KRCCHR-15 | KRC200 |
| | Liberty | 2005 | 2013 | KRCCHR-15 | KRC200 |
| | Patriot | 2007 | 2015 | KRCCHR-15 | KRC200 |
| | Renegade | 2016 | | | KRC300 |
| | Wrangler | 2007 | 2015 | KRCCHR-15 | KRC200 |
| KIA[®] | Forte | 2010 | 2013 | KRCHY-11D | KRC100 |
| | Soul | 2010 | 2011 | KRCHY-11D | KRC100 |
| | Sportage | 2005 | 2008 | KRCHY-4 | KRC100 |
| LEXUS[®] | ES330 | 2004 | 2006 | KRCTOYO-30 | KRC100 |
| | RX330 | 2003 | 2008 | KRCTOYO-30 | KRC100 |
| | RX350 | 2003 | 2008 | KRCTOYO-30 | KRC100 |
| | RX400h | 2005 | 2008 | KRCTOYO-30 | KRC100 |
| LINCOLN[®] | Aviator | 2003 | 2005 | KRCFO-30D | KRC100 |
| | LS | 2000 | 2002 | KRCFO-15D | KRC100 |
| | LS | 2003 | 2006 | KRCFO-30D | KRC100 |
| | Mark LT | 2006 | 2008 | KRCFO-30D | KRC100 |
| | MKS | 2009 | 2009 | KRCFO-30D | KRC100 |
| | MKX | 2007 | 2010 | KRCFO-30D | KRC100 |
| | MKZ | 2007 | 2010 | KRCFO-30D | KRC100 |
| | Navigator | 1998 | 2002 | KRCFO-15D | KRC100 |

GUÍA TELEMANDOS KRC



KRC REMOTES GUIDE



| FOR: |  | FROM | TO |  | REMOTE |
|--------------------|---|------|-----------|--|--------|
| LINCOLN® | Navigator | 2002 | 2010 | KRCFO-30D | KRC100 |
| | Navigator | 2011 | 2012 | KRCFO-30D | KRC100 |
| | Navigator | 2013 | 2014 | | KRC100 |
| | Town Car | 1998 | 2002 | KRCFO-15D | KRC100 |
| | Town Car | 2003 | 2011 | KRCFO-30D | KRC100 |
| | Zephyr | 2006 | 2006 | KRCFO-30D | KRC100 |
| MAZDA® | 2 | 2011 | 2013 | KRCMAZ-11D | KRC100 |
| | 3 | 2003 | 2005 | KRCMAZ-11D | KRC100 |
| | 3 | 2007 | 2008 | KRCMAZ-11D | KRC100 |
| | 3 | 2010 | 2013 | KRCMAZ-11D | KRC100 |
| | 6 | 2003 | 2005 | KRCMAZ-11D | KRC100 |
| | 6 | 2010 | 2012 | KRCMAZ-11D | KRC100 |
| | B-Series | 1999 | 2000 | KRCFO-15D | KRC100 |
| | B-Series | 2001 | 2009 | KRCFO-15D | KRC100 |
| | CX7 | 2006 | 2008 | KRCMAZ-11D | KRC100 |
| | CX7 | 2009 | 2012 | KRCMAZ-11D | KRC100 |
| | CX9 | 2009 | 2013 | KRCMAZ-11D | KRC100 |
| | M5 | 2005 | 2010 | KRCMAZ-11D | KRC100 |
| | M5 | 2010 | 2015 | KRCMAZ-11D | KRC100 |
| | MX-5 | 2005 | 2012 | KRCMAZ-11D | KRC100 |
| | MX-5 | 2009 | 2015 | KRCMAZ-11D | KRC100 |
| | RX8 | 2004 | 2008 | KRCMAZ-11D | KRC100 |
| | Tribute | 2001 | 2004 | KRCFO-15D | KRC100 |
| | Tribute | 2005 | 2007 | KRCFO-15D | KRC100 |
| | Tribute | 2008 | 2011 | KRCFO-15D | KRC100 |
| MERCURY® | Cougar | 1999 | 2001 | KRCFO-16 | KRC100 |
| | Grand Marquis | 2007 | 2011 | KRCFO-30D | KRC100 |
| | Marauder | 2003 | 2005 | KRCFO-30D | KRC100 |
| | Mariner | 2005 | 2006 | KRCFO-30D | KRC100 |
| | Mariner | 2007 | 2010 | KRCFO-30D | KRC100 |
| | Mariner | 2011 | 2011 | KRCFO-30D | KRC100 |
| | Milan | 2006 | 2006 | KRCFO-30D | KRC100 |
| | Milan | 2007 | 2011 | KRCFO-30D | KRC100 |
| | Montego | 2005 | 2007 | KRCFO-30D | KRC100 |
| | Monterey | 2004 | 2007 | KRCFO-30D | KRC100 |
| | Mountaineer | 1998 | 2001 | KRCFO-15D | KRC100 |
| | Mountaineer | 2002 | 2010 | KRCFO-30D | KRC100 |
| | Mystique | 1995 | 2000 | KRCFO-16 | KRC100 |
| | Sable | 1993 | 1997 | KRCFO-15D | KRC100 |
| | Sable LS, LE, SHO | 1998 | 1999 | KRCFO-15D | KRC100 |
| | Sable LS, LE, SHO | 2000 | 2006 | KRCFO-30D | KRC100 |
| Sable LS, LE, SHO | 2008 | 2009 | KRCFO-30D | KRC100 | |
| MITSUBISHI® | Diamante | 2000 | 2003 | KRCMIT-12 | KRC100 |
| | Diamante | 2004 | 2004 | KRCMIT-12 | KRC100 |
| | ECLIPSEExportacion a China | 1999 | 2000 | KRCMIT-18 | KRC100 |
| | ECLIPSEExportacion a China | 2001 | 2001 | KRCMIT-18 | KRC100 |
| | ECLIPSEExportacion a China | 2002 | 2005 | KRCMIT-18 | KRC100 |
| | Endeavor | 2004 | 2005 | KRCMIT-18 | KRC100 |
| | Endeavor | 2006 | 2006 | KRCMIT-18 | KRC100 |

| FOR: |  | FROM | TO |  | REMOTE |
|-------------------------------|---|------|-----------|--|--------|
| mitsubishi[®] | Galant | 2000 | 2001 | KRCMIT-18 | KRC100 |
| | Galant | 2002 | 2003 | KRCMIT-18 | KRC100 |
| | Galant | 2004 | 2005 | KRCMIT-18 | KRC100 |
| | Lancer Evo 8 Europe | 2003 | 2006 | KRCMIT-8D | KRC100 |
| | Montero | 2001 | 2006 | KRCMIT-12 | KRC100 |
| | Montero Sport | 2000 | 2000 | KRCMIT-12 | KRC100 |
| | Montero Sport | 2001 | 2004 | KRCMIT-12 | KRC100 |
| | Outlander | 2003 | 2006 | KRCMIT-8D | KRC100 |
| NISSAN[®] | 350Z | 2003 | 2008 | KRCDAT-15 | KRC100 |
| | Altima | 2002 | 2004 | KRCDAT-15 | KRC100 |
| | Altima | 2005 | 2006 | KRCDAT-15 | KRC100 |
| | Armada | 2004 | 2008 | KRCDAT-15 | KRC100 |
| | Armada | 2009 | 2012 | KRCDAT-15 | KRC100 |
| | Armada | 2013 | 2015 | | KRC100 |
| | Cube | 2009 | 2014 | KRCDAT-15 | KRC100 |
| | Frontier | 2002 | 2004 | | KRC100 |
| | Frontier | 2005 | 2005 | KRCDAT-15 | KRC100 |
| | Frontier | 2006 | 2015 | | KRC100 |
| | Frontier | 2014 | 2014 | KRCDAT-15 | KRC100 |
| | Juke | 2011 | 2012 | KRCDAT-15 | KRC100 |
| | MAXIMA | 2001 | 2001 | KRCDAT-15 | KRC100 |
| | MAXIMA | 2002 | 2003 | KRCDAT-15 | KRC100 |
| | MAXIMA | 2004 | 2006 | KRCDAT-15 | KRC100 |
| | Murano | 2003 | 2007 | KRCDAT-15 | KRC100 |
| | NV | 2012 | 2012 | KRCDAT-15 | KRC100 |
| | NV | 2013 | 2015 | KRCDAT-15 | KRC100 |
| | Pathfinder | 1999 | 2001 | KRCDAT-15 | KRC100 |
| | Pathfinder | 2002 | 2004 | KRCDAT-15 | KRC100 |
| | Pathfinder | 2005 | 2012 | KRCDAT-15 | KRC100 |
| | Quest | 2004 | 2010 | KRCDAT-15 | KRC100 |
| | Rogue | 2008 | 2016 | KRCDAT-15 | KRC100 |
| | Sentra | 2000 | 2004 | KRCDAT-15 | KRC100 |
| | Sentra | 2007 | 2012 | KRCDAT-15 | KRC100 |
| | Sentra | 2012 | 2019 | | KRC100 |
| | Sentra | 2013 | 2015 | | KRC100 |
| | TIIDA | 2013 | 2016 | KRCDAT-15 | KRC100 |
| | Versa | 2007 | 2009 | KRCDAT-15 | KRC100 |
| | Versa | 2010 | 2012 | KRCDAT-15 | KRC100 |
| Versa | 2013 | 2016 | | KRC100 | |
| Versa Note | 2014 | 2016 | | KRC100 | |
| Xterra | 2001 | 2001 | KRCDAT-15 | KRC100 | |
| Xterra | 2002 | 2004 | KRCDAT-15 | KRC100 | |
| Xterra | 2005 | 2011 | KRCDAT-15 | KRC100 | |
| Xterra | 2012 | 2015 | KRCDAT-15 | KRC100 | |
| OLDSMOBILE[®] | Alero | 2001 | 2004 | | KRC100 |
| | Aurora | 2001 | 2003 | KRCGM-28 | KRC100 |
| | Bravada | 2002 | 2004 | | KRC100 |
| | Intrigue | 1998 | 2000 | | KRC100 |
| | Intrigue | 2001 | 2002 | | KRC100 |
| | Silhouette | 1997 | 1998 | KRCGM-27 | KRC100 |
| | Silhouette | 1999 | 2000 | KRCGM-27 | KRC100 |

GUÍA TELEMANDOS KRC

KRC REMOTES GUIDE



| FOR: |  | FROM | TO |  | REMOTE |
|--------------------|---|------|----------|--|--------|
| OLDSMOBILE® | <i>Silhouette</i> | 2001 | 2005 | KRCGM-27 | KRC100 |
| PONTIAC® | <i>Aztek</i> | 2001 | 2005 | KRCGM-28 | KRC100 |
| | <i>Bonneville</i> | 2001 | 2005 | KRCGM-28 | KRC100 |
| | <i>G5</i> | 2007 | 2010 | KRCGM-37 | KRC100 |
| | <i>G6</i> | 2006 | 2010 | KRCGM-37 | KRC100 |
| | <i>Grand Am</i> | 2001 | 2005 | | KRC100 |
| | <i>Grand Prix</i> | 2001 | 2003 | KRCGM-43 | KRC100 |
| | <i>Grand Prix</i> | 2004 | 2004 | KRCGM-37 | KRC100 |
| | <i>Grand Prix</i> | 2006 | 2008 | KRCGM-37 | KRC100 |
| | <i>Montana</i> | 1999 | 2000 | KRCGM-27 | KRC100 |
| | <i>Montana</i> | 2001 | 2004 | KRCGM-27 | KRC100 |
| | <i>Montana</i> | 2005 | 2005 | KRCGM-27 | KRC100 |
| | <i>Montana</i> | 2005 | 2006 | KRCGM-37 | KRC100 |
| | <i>Montana</i> | 2007 | 2009 | KRCGM-28 | KRC100 |
| | <i>Solstice</i> | 2006 | 2006 | KRCGM-37 | KRC100 |
| | <i>Solstice</i> | 2007 | 2009 | KRCGM-37 | KRC100 |
| | <i>Torrent</i> | 2007 | 2009 | KRCGM-37 | KRC100 |
| <i>Trans Sport</i> | 1997 | 1998 | KRCGM-27 | KRC100 | |
| SATURN® | <i>Aura</i> | 2007 | 2010 | KRCGM-37 | KRC100 |
| | <i>Outlook</i> | 2007 | 2010 | KRCGM-37 | KRC100 |
| | <i>Relay 1/2/3</i> | 2005 | 2006 | KRCGM-27 | KRC100 |
| | <i>Relay 1/2/3</i> | 2007 | 2007 | KRCGM-27 | KRC100 |
| | <i>Sky</i> | 2007 | 2010 | KRCGM-37 | KRC100 |
| | <i>Vue</i> | 2008 | 2009 | KRCDAE-4D | KRC100 |
| SUBARU® | <i>Liberty</i> | 2009 | 2013 | KRCSUB-2 | KRC100 |
| SUZUKI® | <i>XL7</i> | 2007 | 2008 | | KRC100 |
| TOYOTA® | <i>4Runner</i> | 1999 | 2002 | KRCTOYO-15 | KRC100 |
| | <i>4Runner</i> | 2010 | 2016 | KRCTOYO-15 | KRC100 |
| | <i>4Runner USA</i> | 2002 | 2009 | KRCTOYO-15 | KRC100 |
| | <i>Avalon</i> | 2002 | 2004 | KRCTOYO-15 | KRC100 |
| | <i>Camry</i> | 2002 | 2006 | KRCTOYO-15 | KRC100 |
| | <i>Camry</i> | 2006 | 2011 | KRCTOYO-15 | KRC100 |
| | <i>Camry</i> | 2012 | 2016 | | KRC100 |
| | <i>Camry</i> | 2015 | 2016 | KRCTOYO-15 | KRC100 |
| | <i>COROLLA</i> | 2003 | 2005 | KRCTOYO-15 | KRC100 |
| | <i>COROLLA</i> | 2005 | 2008 | KRCTOYO-15 | KRC100 |
| | <i>Corolla</i> | 2009 | 2010 | KRCTOYO-15 | KRC100 |
| | <i>COROLLA</i> | 2014 | 2016 | KRCTOYO-15 | KRC100 |
| | <i>Echo</i> | 2005 | 2008 | | KRC100 |
| | <i>FJ Cruiser</i> | 2007 | 2008 | KRCTOYO-15 | KRC100 |
| | <i>FJ Cruiser</i> | 2008 | 2009 | KRCTOYO-15 | KRC100 |
| | <i>FJ Cruiser</i> | 2010 | 2010 | KRCTOYO-15 | KRC100 |
| | <i>FJ Cruiser</i> | 2011 | 2014 | KRCTOYO-15 | KRC100 |
| | <i>Highlander</i> | 2001 | 2003 | KRCTOYO-15 | KRC100 |
| | <i>Highlander</i> | 2004 | 2007 | KRCTOYO-15 | KRC100 |
| | <i>Land Cruiser</i> | 2006 | 2007 | KRCTOYO-15 | KRC100 |
| | <i>LELICA</i> | 2004 | 2005 | KRCTOYO-15 | KRC100 |
| | <i>Matrix</i> | 2004 | 2008 | KRCTOYO-15 | KRC100 |
| | <i>Prius</i> | 2001 | 2003 | KRCTOYO-15 | KRC100 |
| | <i>RAV4</i> | 2001 | 2003 | KRCTOYO-15 | KRC100 |
| | <i>RAV4</i> | 2004 | 2005 | KRCTOYO-15 | KRC100 |

| FOR: |  | FROM | TO |  | REMOTE |
|---------------------|---|------|------|--|--------|
| TOYOTA [®] | RAV4 | 2006 | 2010 | KRCTOYO-15 | KRC100 |
| | RAV4 | 2010 | 2012 | KRCTOYO-15 | KRC100 |
| | RAV4 | 2010 | 2012 | KRCTOYO-15 | KRC100 |
| | Sequoia | 2001 | 2003 | KRCTOYO-15 | KRC100 |
| | Sequoia | 2004 | 2007 | KRCTOYO-15 | KRC100 |
| | Sienna | 1999 | 2003 | KRCTOYO-15 | KRC100 |
| | Sienna | 2001 | 2003 | KRCTOYO-15 | KRC100 |
| | Sienna | 2002 | 2003 | KRCTOYO-15 | KRC100 |
| | Thailand | 2005 | 2009 | KRCTOYO-15 | KRC100 |
| | Tundra | 2004 | 2005 | KRCTOYO-15 | KRC100 |
| | Tundra | 2006 | 2006 | KRCTOYO-15 | KRC100 |
| | YARIS | 2006 | 2010 | KRCTOYO-15 | KRC100 |
| | YARIS | 2007 | 2011 | KRCTOYO-15 | KRC100 |
| | YARIS | 2012 | 2014 | KRCTOYO-15 | KRC100 |
| VW [®] | Beetle | 1998 | 1999 | KRCHU-HAA | KRC100 |
| | Beetle | 2000 | 2001 | KRCHU-HAA | KRC100 |
| | Beetle | 2002 | 2010 | KRCHU-HAA | KRC100 |
| | EOS | 2007 | 2013 | KRCHU-HAA | KRC100 |
| | Golf | 1999 | 2010 | | KRC100 |
| | Golf | 2010 | 2013 | KRCHU-HAA | KRC100 |
| | JETTA | 1999 | 2010 | KRCHU-HAA | KRC100 |
| | JETTA | 2010 | 2013 | KRCHU-HAA | KRC100 |
| | JETTA | 2013 | 2016 | KRCHU-HAA | KRC100 |
| | PASSAT | 2001 | 2005 | KRCHU-HAA | KRC100 |
| | TIGUAN | 2008 | 2011 | KRCHU-HAA | KRC100 |
| | TIGUAN | 2008 | 2013 | KRCHU-HAA | KRC100 |
| | Touareg | 2003 | 2007 | KRCHU-HAA | KRC200 |

GUÍA TELEMANDOS KRC

KRC REMOTES GUIDE

AUSTRALIA

| FOR: |  | FROM | TO |  | REMOTE |
|-------------|---|------|------|--|--------|
| FORD® | FALCON | 2000 | 2002 | | KRC100 |
| | FALCON | 2002 | 2008 | KRCFO-6 | KRC100 |
| | FALCON | 2005 | 2008 | KRCFO-24 | KRC100 |
| | FALCON | 2008 | 2011 | KRCFO-24 | KRC100 |
| | Territory | 2004 | 2011 | KRCFO-6 | KRC100 |
| | Territory | 2009 | 2011 | KRCFO-24 | KRC100 |
| HONDA® | Accord | 2003 | 2007 | KRCHON-31 | KRC100 |
| HYUNDAI® | iLoad | 2007 | 2014 | KRCHY-11 | KRC100 |
| | iMax | 2007 | 2015 | KRCHY-11 | KRC100 |
| | LANTRA | 2000 | 2006 | KRCHY-4 | KRC100 |
| | LAVITA | 2000 | 2006 | KRCHY-4 | KRC100 |
| MAZDA® | 2 | 2010 | 2014 | KRCMAZ-11D | KRC100 |
| | 3 | 2004 | 2008 | KRCMAZ-11D | KRC100 |
| | 6 | 2010 | 2013 | KRCMAZ-11D | KRC100 |
| | Tribute | 2001 | 2004 | KRCFO-15D | KRC100 |
| MITSUBISHI® | Mirage | 2012 | | KRCMIT-12 | KRC100 |
| | TRITON | 2006 | 2015 | KRCMIT-12 | KRC100 |
| NISSAN® | 350Z | 2002 | 2005 | KRCDAT-15 | KRC100 |
| | Murano | 2005 | 2008 | KRCDAT-15 | KRC100 |
| | Pathfinder | 2002 | 2005 | KRCDAT-15 | KRC100 |
| | TIIDA | 2005 | 2013 | KRCDAT-15 | KRC100 |
| | X-TRAIL | 2001 | 2003 | | KRC100 |
| | X-TRAIL | 2004 | 2007 | KRCDAT-15 | KRC100 |
| SEAT® | Altea | 2004 | 2010 | KRCHU-HAA | KRC100 |
| SUBARU® | Outback | 2009 | 2013 | KRCSUB-2 | KRC100 |
| SUZUKI® | Grand Vitara | 2005 | 2013 | | KRC100 |
| TOYOTA® | Camry | 2011 | 2015 | KRCTOYO-15 | KRC100 |
| | COROLLA | 2010 | 2013 | KRCTOYO-15 | KRC100 |
| | HIACE | 2010 | 2012 | KRCTOYO-15 | KRC100 |
| VW® | PASSAT | 2010 | 2013 | KRCHU-HAA | KRC100 |
| | Santana | 2013 | | | KRC100 |
| | Vento | 2010 | | KRCHU-HAA | KRC100 |

TIPOS DE ESPADINES

*ESPADIN MOTAK
TYPES OF BLADES
TYPES D'ESPADINES
ARTEN VON ESPADINEN*



THE KEY TO EXCELLENCE
GLOBALLY UNLOCKING MILLIONS OF DOORS DAILY

FOR: CHRYSLER®



LAT.

L.... 1-3580

KRCCHR-15

FOR: DACIA®



LAT.

KRCDAC-4D

FOR: DAEWOO®



LAT.

T-V....
1-1200
KRCDAE-4

FOR: FORD®



LAT.

....X
0001-1706
KRCFO-15D

FOR:
CHRYSLER®
DACIA®
DAEWOO®
FORD®
GENERAL
MOTORS®
HONDA®
HUF®

FOR: FORD®

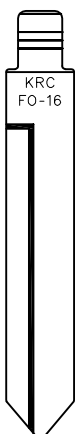

LAT.

...A...
101-291
501-579
...B...
101-332
501-602
...C...
101-344
501-624
...D...
101-327
501-602
...E...
101-296
501-579

KRCFO-16



LAT.

KRCFO-30D

FOR: GENERAL MOTORS®

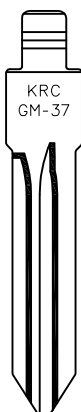

LAT.

KRCGM-37



LAT.

60000-62113
KRCGM-49D

FOR: HONDA®



LAT.

...K001-N718
KRCHOND-31

FOR: HUF®

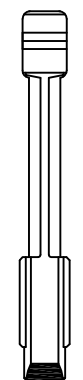

LAT.

T....
1 AL 4
001-1050
KRCFO-6

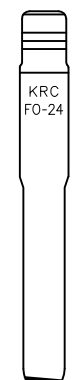

LAT.

....1-4000
KRCFO-24



LAT.

KRCHU-HAA

FOR:
 HUF®
 HYUNDAI®
 ISUZU®
 KIA®
 MAZDA®
 MITSUBISHI®

FOR: HUF®

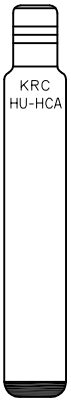

KRC
HU-HCA

LAT.



KRCHU-HCA



KRC
OP-11

LAT.

Z...
1-2000
2001-4000
4001-6000



KRCOP-11



KRC
OP-S

LAT.

S...
0001-5200



KRCOP-S

FOR: YMOS®

FOR: HYUNDAI®



KRC
HY-4

LAT.

T
0001-1000



KRCHY-4

FOR: KIA®

FOR: HYUNDAI®



KRC
HY-6D

LAT.

S...
1-1000



KRCHY-6D

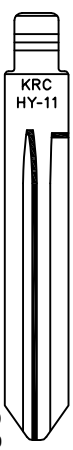

KRC
HY-11

LAT.

H...0001-2500
M...0001-2500
P...0001-2500
T...0001-2500
V...1-2500



KRCHY-11

FOR: KIA®

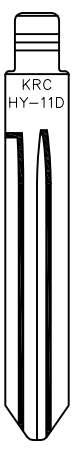

KRC
HY-11D

LAT.

M...1-2500
T...1-2500
WC...1001-3500



KRCHY-11D

FOR: ISUZU®

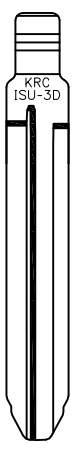

KRC
ISU-3D

LAT.



KRCISU-3D

FOR: KIA®

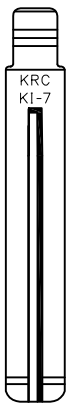

KRC
KI-7

LAT.

K...0001-2500
P...0001-2500



KRCKI-7

FOR: MAZDA®

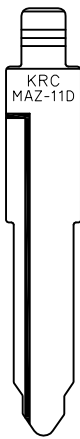

KRC
MAZ-11D

LAT.

...
10100-12099
20100-23284



KRCPMAZ-11D

FOR: MITSUBISHI®



KRC
MIT-8D

LAT.

30010-32009



KRCPMIT-8D

FOR: MITSUBISHI®



KRC
MIT-12

LAT.

E
5001-7679
7001-7700



KRCPMIT-12



FOR: NEIMAN ®

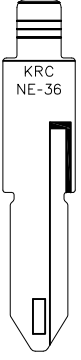

KRC
NE-36

LAT.

.....1/9..A/Z
...1/9....
1/9.....A/Z
.1/9.....A/Z
..1/9.....A/Z
...1/9..A/Z
....1/9..A/Z
.....1/9..A/Z A/Z



KRCNE-36

FOR: NISSAN ®

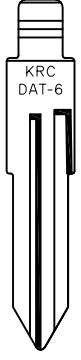

KRC
DAT-6

LAT.

X....1-8000
X....8001-9000



KRCDAT-6



KRC
DAT-15

LAT.

.....1-22185



KRCDAT-15

FOR: USHIN ®

FOR: SUBARU ®

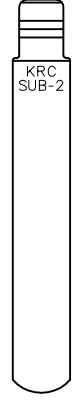

KRC
SUB-2

LAT.

T....1-3000



KRCSUB-2

FOR:
NEIMAN ®
NISSAN ®
SUBARU ®
SUZUKI ®
TOYOTA ®
TRW-SIPEA ®

FOR: SUZUKI ®

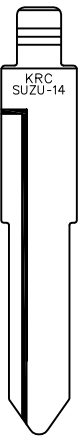

KRC
SUZU-14

LAT.

.....50001-51308
U....1-2000
V....1-2000



KRCSUZU-14

FOR: TOYOTA ®

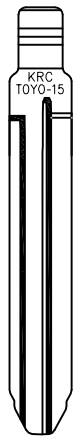

KRC
TOYO-15

LAT.

.....
10001-15000



KRCTOYO-15

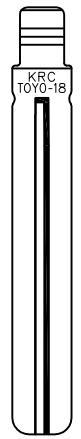

KRC
TOYO-18

LAT.

.....1-5000



KRCTOYO-18

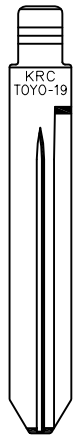

KRC
TOYO-19

LAT.

.....1-13284



KRCTOYO-19

FOR: TOYOTA ®

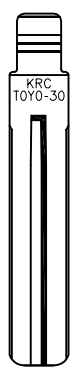

KRC
TOYO-30

LAT.



KRCTOYO-30

FOR: TRW-SIPEA ®



KRC
FI-11

LAT.

N 6001-7000
J 3001-6732
V 0001-3051
V 5001-8058
AB 6001-6891



KRCFI-11



KRC
FI-13

LAT.

W....
0001-9640



KRCFI-13

FOR: GIOBERT ®

FOR: TRW-SIPEA ®

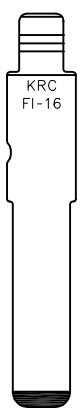

KRC
FI-16

LAT.



KRCFI-16

FOR: GIOBERT ®



FOR:
USHIN®
VACHETTE®

FOR: USHIN®

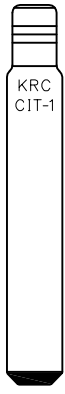

LAT.

.....1-2-3-4-Q-5-6-7-8-H
.....A-B-C-D-E-F



KRCCIT-1

FOR: VACHETTE®



LAT.

....A/Z 0/9
1-4092
....A/Z 0/9
5001-9092
....A/Z 0/9
1-4092
....A/Z 0/9
5001-9092



KRCVA-34

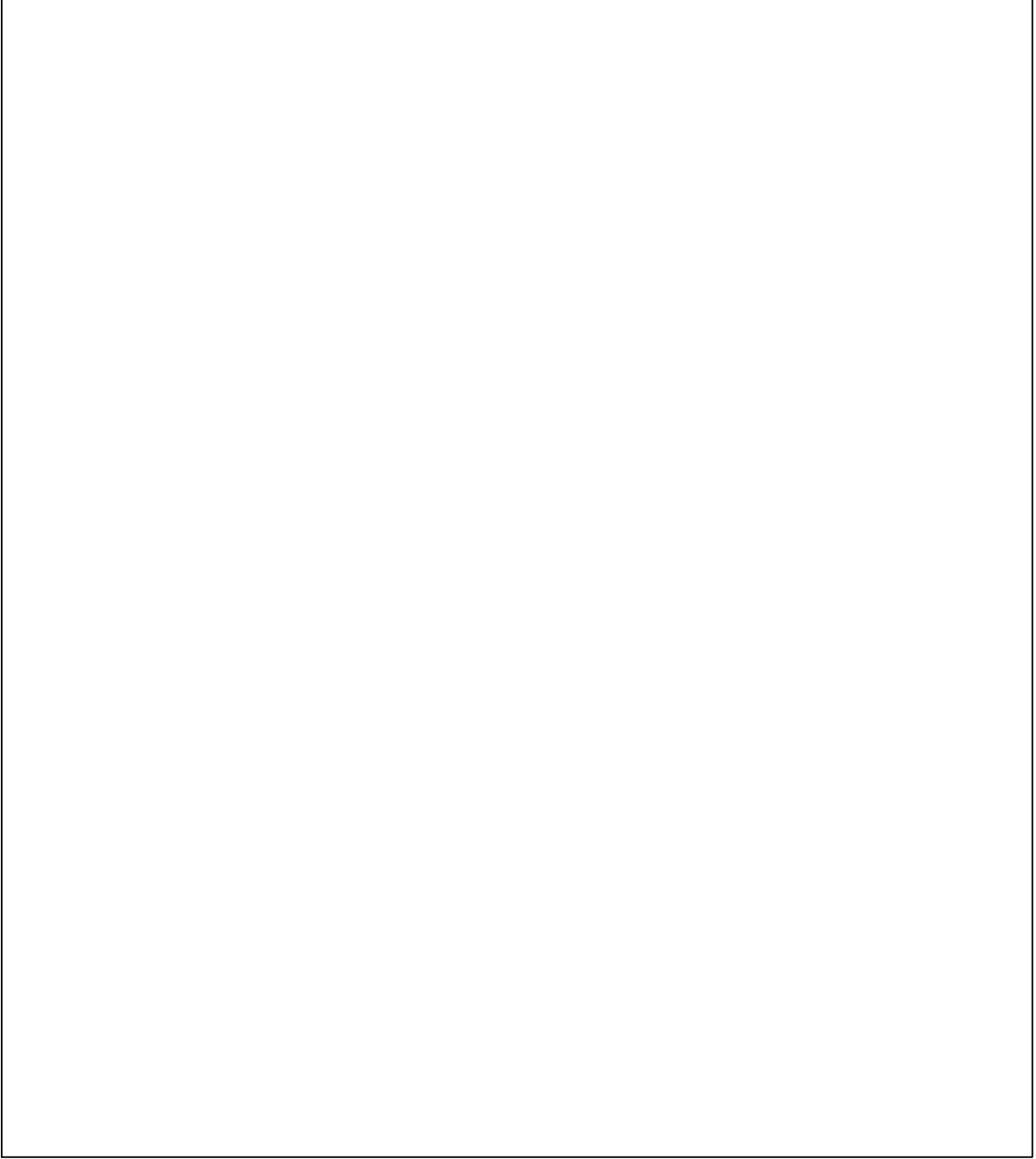

JMA SPAIN

JMA ALEJANDRO ALTUNA, S.L.U.
Tel +34 943 79 30 00
Bidekurtzeta, 6 P.O.Box - Apdo. 70
20500 Arrasate - Mondragón
Gipuzkoa – SPAIN
www.jma.es
ventas@jma.es

JMA FRANCE

JMA FRANCE SAS
Tel +33 01 39 22 42 10
Technoparc
13, rue Edouard Jeanneret
F- 78306 Poissy Cedex
www.jmafrance.fr
service.commercial@jmafrance.fr

JMA POLSKA

JMA POLSKA Sp. z o.o.
Tel +48 42 635 12 80
91- 342 Łódź, ul. Zbąszyńska 3
www.jmapolska.pl
biuro@jmapolska.pl

JMA PORTUGAL

ALTUNA PORTUGAL
COMERCIO DE CHAVES UNIPESSOAL, LDA.
Tel +351 219 947 470
Rua de Goa Nº22
2690-356 Santa Iria de Azoia
www.jmaportugal.com
comercial@jmaportugal.com

JMA UK

SKS T/A JMA UK
Tel +44 144 229 1400
Unit 2, Canalside Northbridge Road
Berkhamsted
Herts HP4 1EG
www.jma-uk.co.uk
sales@jma-uk.co.uk

JMA MAROC S.A.R.L.

Tel +0520 150 535
83,85 Bd Oued ZIZ, El Oulfa
Casablanca
www.jma.ma
jma@jma.ma

JMA MEXICO

LLAVES ALTUNA DE MEXICO S.A de C.V
Tel +52 33 3777 1600
Av. Aviación No. 5520
Col. San Juan de Ocotán
C.P. 45019 Zapopan, Jalisco
www.jma.com.mx
ventas@jma.com.mx

JMA PERU

JMA PERU S.A.C.
Tel +51 639 9300
Av. Los Paracas 130,
Urbanización Salamanca,
Distrito Ate, Lima
www.jma-peru.com
info@jma-peru.com

JMA COLOMBIA

IFAM - JMA Colombia, S.A.S.
Tel +57 1 53333246
Fax +57 3203497446
Diagonal 115A - 70B - 45 Local 1
Bogotá
www.jmacolombia.com
info@jmacolombia.com

JMA USA

ALTUNA GROUP USA INC.
Tel +1 817 385 0515
1513 Greenview Drive
75050 Grand Prairie
Texas
www.jmausa.com
info@jmausa.com

Tel +34 943 79 30 00
Fax +34 943 79 72 43
Bidekurtzeta, 6 P.O.Box - Apdo. 70
Arrasate - Mondragón 20500
Gipuzkoa – SPAIN

Member of
Altuna Group