



# ED5000 Series

# Product Catalog

Experience a safer  
and more open world

# Overview

## ED5000 Series

### Table of Contents

Overview .....	2
Product Series Features .....	3
Applications and Listings.....	4
SecureBolt® Features.....	6
Rim Features .....	8
Surface Vertical	
Rod Features.....	10
Concealed Vertical	
Rod Features .....	14
Rim/SecureBolt/SVR & CVR	
Functions .....	18
Trims and Functions .....	20
Mortise Features .....	26
Mortise Functions .....	28
Mortise Trims and	
Functions .....	30
Electrified Exit Devices.....	36
Mullions and	
Surface Bolt Kit.....	49
Options and Accessories ...	50
Facts and Figures .....	53
Cylinders.....	54
Quick Codes .....	58
How to Order .....	59
Helpful Terms .....	62
How to Specify .....	63

[www.corbinrusswin.com](http://www.corbinrusswin.com)

### Applications

Corbin Russwin's history is rich with architectural hardware designed to meet life safety and security requirements. That tradition continues with ED5000 Series exit devices. Designed to allow safe and easy egress, the ED5000 Series is ideal for frequent use applications such as schools, factories, hotels, theaters, office, retail complexes and government buildings.

### Quality

All exit devices manufactured by Corbin Russwin undergo rigorous testing, both in the lab and field. Testing procedures go beyond industry standards; the ED5800 concealed vertical rod exit device was witnessed and certified to 3.25 million successful cycles, more than 6 times the requirement. Abuse and cycle tests prove time and again the durability of the entire ED5000 Series, which is backed by a 5-year warranty.

### Aesthetics

Over the past 100 years, Corbin Russwin has been well-known for weaving pleasing aesthetics and inventive designs into architectural door hardware, and today's wide stile exit device line is no exception. The ED5000 Series offers smooth lines in the exit device bar and a full range of trim designs with visual diversity, including the Muséo® and Vineyard™ Collections.

### Vandal Resistance

Today's door hardware must fulfill life-safety and security needs, two areas in which ED5000 series exit devices and trim excel. The ED5200S SecureBolt® features a deadbolt style latchbolt that significantly resists pull from the exterior, thus reducing door and frame separation, preventing the door from being forced open. 900 series heavy-duty trim deters vandals with a thick 13/16" beveled escutcheon, Free Wheeling lever (excluding mortise trim), and flush cylinder. High security Pyramid cylinders offer an additional barrier against picking and drilling. These components can all be combined for high quality, high security applications.

### Electronics

If electronic access control is required, or just a simple monitoring switch, the ED5000 series offers a full range of electrified options, including a delayed egress exit device and electrically controlled trim. All options can be tied into existing security and fire alarm systems for easy monitoring.

# Product Series Features

## ED5000 Series

As Corbin Russwin continues to offer the latest technology and architectural hardware, an additional option is also presented to architects, distributors, and end-users. The power of choice. With a wide variety of devices, trims, lever designs, and electrified hardware, a locking system can be designed for any building and any application. Below are some highlights of the ED5000 Series. These are but a few of the options that can be combined to meet the aesthetic and security requirements of today.



SecureBolt® Delayed Egress Exit Device

**SECUREBOLT**

### SecureBolt®

- Deadbolt-style latch design provides increased security by resisting unauthorized entrance from credit cards, crowbars, door rattling, etc.
- Is more resistant to vector forces, which results in less force against the frame, thus eliminating door/frame separation
- Provides increased stability of openings with mullions

### Delayed Egress Exit Device

- Increases security in many applications such as retail stores and health care facilities
- Features an LED indicator and a nuisance delay
- 15 or 30-second delay available
- UL and BHMA listed



**PATHLITE**

### Photoluminescent Touchpad Cover

The PathLite™ patent pending technology offers a number of benefits:

- Requires no wiring or maintenance
- Recharges with exposure to ambient light
- Unaffected by heat or cold
- Non-toxic, will not rub or fade
- Vandal resistant

- Fire resistant and non-radioactive
- Green contrasting word "EXIT" centered on touchbar in 1-1/4" high lettering
- Cost effective; especially suited for existing buildings

PathLite™ photoluminescent exit devices meet New York City's newly adopted standards for requirement of photoluminescent signage and stairwell markings in all office buildings in excess of 75 feet in height.



Heavy-Duty Trim with Vineyard lever

Vineyard™ collection

Heavy-Duty Trim with Muséo lever

**MU  
SÉO**

Parabolic Trim with Vineyard™ lever Specify M60

### Heavy-Duty Trim

- Free Wheeling levers for vandal resistance (excluding mortise trim)
- Heavy-duty threaded posts provide additional strength
- Beveled sides for increased attack resistance
- Flush cylinder when used with 6-pin applications and mortise trim functions

### Muséo® and Vineyard™ Collections





- Available in 605, 606, 611, 612, 613, 613E, 618, 619, 625, 626, 722, BSP, WSP finishes
- Allows for design continuum when matched with the ML2000 series mortise lock *Muséo* and *Vineyard* Collection trims
- Heavy-duty vandal-resistant escutcheon increases security

### Parabolic Trim with Vineyard™ Lever

- Specify M60

# Applications and Listings

## ED5000 Series

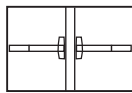
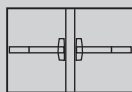
Single Door	UL Listing	Maximum Opening (W x H)	Application	
<b>Rim</b>				
ED5200	Panic	4' x *	Surface applied; single-point latching.	
ED5200A	3 Hr.	4' x 8'		
ED5202	Panic	4' x 8'		
ED5202A	3 Hr.	4' x 8'		
<b>SecureBolt®</b>				
ED5200S	Panic	4' x 8'	Surface applied; single-point latching.	
ED5200SA	3 Hr.	4' x 8'		
ED5200S x M107	Panic	4' x 8'	Surface applied; single-point latching. Used as components in swinging door windstorm-rated assemblies (refer to local codes).	
ED5200SA x M107	3 Hr.	4' x 8'		
ED5202S	Panic	4' x 8'		
ED5202SA	3 Hr.	4' x 8'		
<b>Mortise</b>				
ED5600	Panic	4' x *	Mortised in door; single-point latching.	
ED5600A	3 Hr.	4' x 8'		
ED5602L	Panic	4' x 8'		
ED5602AL	3 Hr.	4' x 8'		
<b>Surface Vertical Rod</b>				
ED5400	Panic	4' x 8'	Surface applied; two-point latching.	
ED5400A	3 Hr.	4' x 8'		
ED5470	Panic	4' x 10'	Surface applied; one-point latching.	
ED5470 x M55	Panic	4' x 10'		
ED5470 x M107	Panic	4' x 8'		
ED5470B	1-1/2 Hr	4' x 10'	Surface applied; two-point latching. Used as components in swinging door windstorm-rated assemblies (refer to local codes).	
<b>Concealed Vertical Rod</b>				
ED5800	Panic	4' x 8'	Rods concealed in door; two-point latching.	
ED5800A	3 Hr.	4' x 8'		
ED5860	Panic	4' x 10'	Rod concealed in door; one point latching.	
ED5860 x M55	Panic	4' x 10'		
ED5860B	1-1/2 Hr.	4' x 10'		
<b>Pair of Doors with Removable Mullion</b>				
	UL Listing	Maximum Opening (W x H)	Application	
<b>Rim x Rim</b>				
ED5200 x ED5200 x CR900 Series	Panic	8' x 10'	Two independent active doors with removable mullion.	
ED5200A x ED5200A x CR900 Series	3 Hr.	8' x 8'		
<b>SecureBolt® x SecureBolt®</b>				
ED5200S x ED5200S x CR900 Series	Panic	8' x 10'	Two independent active doors with removable mullion.	
ED5200SA x ED5200SA x CR900 Series	3 Hr.	8' x 8'		
ED5200S x ED5200S x M107	Panic	8' x 8'	Two independent active doors with removable mullion. Used as components in swinging door windstorm-rated assemblies (refer to local codes).	
ED5200SA x ED5200SA x M107	3 Hr.	8' x 8'		

\*UL does not set a door height limitation on panic applications.

# Applications and Listings

## ED5000 Series

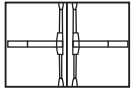
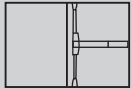
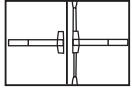
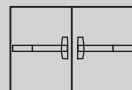
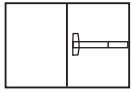
Pairs of Doors	UL Listing	Maximum Opening (W x H)	Application	
<b>Surface Vertical Rod</b>				
ED5400 x ED5400	Panic	8' x 8'	Two independent doors with two-point latching, swinging in the same direction.	
ED5400A x ED5400A	3 Hr.	8' x 8'		
ED5470 x ED5470	Panic	8' x 10'	Two independent doors with one or two-point latching, swinging in the same direction.	
ED5470B x ED5470B	1-1/2 Hr.	8' x 10'		
ED5470 x ED5470 x M107	Panic	8' x 8'	Two independent doors with two-point latching, swinging in opposite directions. Used as components in swinging door windstorm-rated assemblies (refer to local codes).	
ED5470B x ED5470B x M107	1-1/2 Hr.	8' x 8'		
<b>Surface Vertical Rod (Double Egress)</b>				
ED5400 x ED5400	Panic	8' x 8'	Two independent doors with two-point latching, swinging in opposite directions. Overlapping astragal required for 3-hour openings.	
ED5400A x ED5400A	3 Hr.	8' x 8'		
ED5470 x ED5470	Panic	8' x 10'	Two independent doors with one or two-point latching, swinging in opposite directions. Overlapping astragal not required.	
ED5470B x ED5470B	1-1/2 Hr.	8' x 10'		
<b>Surface Vertical Rod x Mortise</b>				
ED5400 x ED5600	Panic	8' x 8'	Overlapping astragal required for 3-hour openings. Coordinator required with standard ANSI strike.	
ED5400A x ED5600A	3 Hr.	8' x 8'		
ED5400A x ED5600A x Open Back Strike	1-1/2 Hr.	8' x 8'		
ED5470 x ED5600	Panic	8' x 10'	Overlapping astragal required for fire-rated openings. Coordinator required with standard ANSI strike.	
ED5470B x ED5600A	1-1/2 Hr.	8' x 9'		
<b>Concealed Vertical Rod</b>				
ED5800 x ED5600	Panic	8' x 8'	Two independent metal doors with two-point latching, swinging in the same direction.	
ED5800 x ED5800	Panic	8' x 8'		
ED5800A x ED5600A	3 Hr.	8' x 8'		
ED5800A x ED5800A	3 Hr.	8' x 8'		
ED5800A x ED5600A x Open Back Strike	1-1/2 Hr.	8' x 8'		
ED5860 x ED5600	Panic	8' x 10'	Two independent metal or wood doors with one or two-point latching, swinging in the same direction.	
ED5860 x ED5860	Panic	8' x 10'		
ED5860B x ED5600A	1-1/2 Hr.	8' x 10'		
ED5860B x ED5860B	1-1/2 Hr.	8' x 10'		
<b>Concealed Vertical Rod (Double Egress)</b>				
ED5800 x ED5800	Panic	8' x 8'	Two independent metal doors with two-point latching, swinging in opposite directions. Overlapping astragal required for 3-hour openings.	
ED5800A x ED5800A	3 Hr.	8' x 8'		
ED5860 x ED5860	Panic	8' x 10'	Two independent metal or wood doors with one or two-point latching, swinging in opposite directions. Overlapping astragal not required.	
ED5860B x ED5860B	1-1/2 Hr.	8' x 10'		

\*UL does not set a door height limitation on panic applications.



# SecureBolt® Features

## ED5000 Series

- ED5200S** Panic-Listed SecureBolt® Exit Device  
**ED5200SA** 3-Hour Fire-Listed SecureBolt® Exit Device  
**ED5202S** Panic-Listed SecureBolt® Double Cylinder Exit Device  
**ED5202SA** 3-Hour Fire-Listed SecureBolt® Double Cylinder Exit Device

SECUREBOLT®



### Features

#### Handing

Standard device is non-handed.  
 Double Cylinder Device is handed.  
 Lever trim is handed.

#### Bar Length

Easily field cut to size.  
 Standard: 36" (914mm) bar fits 30" - 36" (762mm-914mm) door.  
 Optional: 24" (610mm) bar fits 24" (610mm) door; specify W024.  
 Optional: 48" (1219mm) bar fits 36" -48" (914mm-1219mm) door; specify W048.

#### Door Thickness

1-3/4" (44mm) standard.  
 Optional: 2" (51mm); specify D200.  
 Optional: 2-1/4" (57mm); specify D214.

#### Stile

Minimum width 4-1/2" (114mm).

#### Latchbolt

Full 3/4" (19mm) projection, 1" (25mm) wide, positive deadlocking by auxiliary bolt.

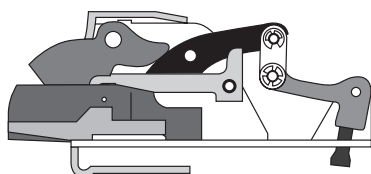

Cut Away Side View

#### Materials

**Latchbolt:** Nickel steel. Slide-action deadbolt with positive deadlocking by auxiliary bolt. Two-piece deadbolt mechanism utilizing a roll back lever which eliminates any contact (friction) with the strike during relocking.

**Device:** Heavy duty cold forged steel chassis; heavy gauge steel mechanisms, electroplated for corrosion resistance; finished parts are brass, bronze or stainless steel; stainless steel springs; nylon bearings.

#### Projection

3-1/4" (83mm) active, 2-3/4" (70mm) dogged.

#### Dogging

Standard on panic-rated devices; single-point 1/4 turn hex key dogging.  
 Optional: less dogging, specify M51.  
 Optional: cylinder dogging; specify M52.  
 Optional: electric dogging; specify M97.  
 Mechanical dogging not available on fire-rated devices.

#### Fasteners

Standard on panic devices: machine screws and wood door fasteners.

Standard on fire-rated devices: sex nuts and bolts.

Optional on devices: sex nuts and bolts for use on wood, composite or unreinforced metal doors; specify M54.

Optional wood screws for use on approved fire-rated solid wood or wood core doors. Specify M64.

#### Strike

Surface mounted 3/8" (10mm) diameter roller strike, complete with positive locking plate and shims, assuring low friction relocking for a long, trouble-free life.

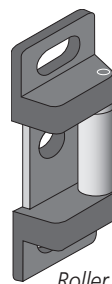

Roller Strike

#### Functions and Trims

Through-bolted lever, pull and thumbpiece trims available with wide range of functions; see Trims and Functions, pages 28-35.

#### Cylinders

Cylinder not included unless specified. See Quick Codes, page 54.

#### Removable Mullion

See Mullions, page 49.

#### Shim Kit

Optional for mounting device over raised vision light molding; specify M58.

#### Applications and Listings

See page 4.

#### Warranty

Five-year limited.

### Certification/Compliance

#### ANSI

Meets A156.3, Type 28, Grade 1.  
 Meets A117.1 Accessibility Code.

#### UL/cUL

All devices listed for safety as panic hardware; devices comply with UL 305 standards for panic hardware. Three-hour fire-rated devices listed as fire exit hardware for A label and lesser class 4' x 8' single or 8' x 8' double doors; UL symbol on active case cover indicates listing. Any retrofit or other field modification to a

fire-rated opening can potentially impact the fire rating of the opening, and Corbin Russwin, Inc. makes no representations or warranties concerning what such impact may be in any specific situation. When retrofitting any portion of an existing fire-rated opening, or specifying and installing a new fire-rated opening, please consult with a code specialist or local code official (Authority Having Jurisdiction) to ensure compliance with all applicable codes and ratings.

#### California State Reference Code

This product has been approved by the California State Fire Marshal pursuant to section 13144.1 of the California Health and Safety Code.

#### NFPA

All exit devices comply with NFPA 101 Life Safety Code. All fire-rated devices comply with NFPA 80 Fire Doors and Windows.

#### ADA

Exit devices, lever trims and pulls comply with Americans with Disabilities Act.

### Finishes

BHMA 605	Bright Brass
BHMA 606	Satin Brass
BHMA 611	Bright Bronze
BHMA 612	Satin Bronze
BHMA 613	Oxidized Bronze, oil rubbed, available lacquered
613E	Dark Oxidized Satin Bronze Equivalent
BHMA 618	Bright Nickel Plated
BHMA 619	Satin Nickel Plated
BHMA 625	Bright Chromium Plated
BHMA 626 <sup>1</sup> (Trim only)	Satin Chromium Plated
626C <sup>2</sup>	Satin Chromium Plated with MicroShield®
BHMA 629	Bright Stainless Steel
BHMA 630	Satin Stainless Steel
630C <sup>2</sup>	Satin Stainless Steel with MicroShield®
722	Black oxidized bronze, oil rubbed
BSP	Black Suede Powder
WSP	White Suede Powder Coat

**1. Contact factory for devices required in BHMA 626**

**2. Finish available with MicroShield® antimicrobial coating.**

# SecureBolt® Features

## ED5000 Series

### ED5200S and ED5200SA SecureBolt® Exit Devices

**SECUREBOLT®**

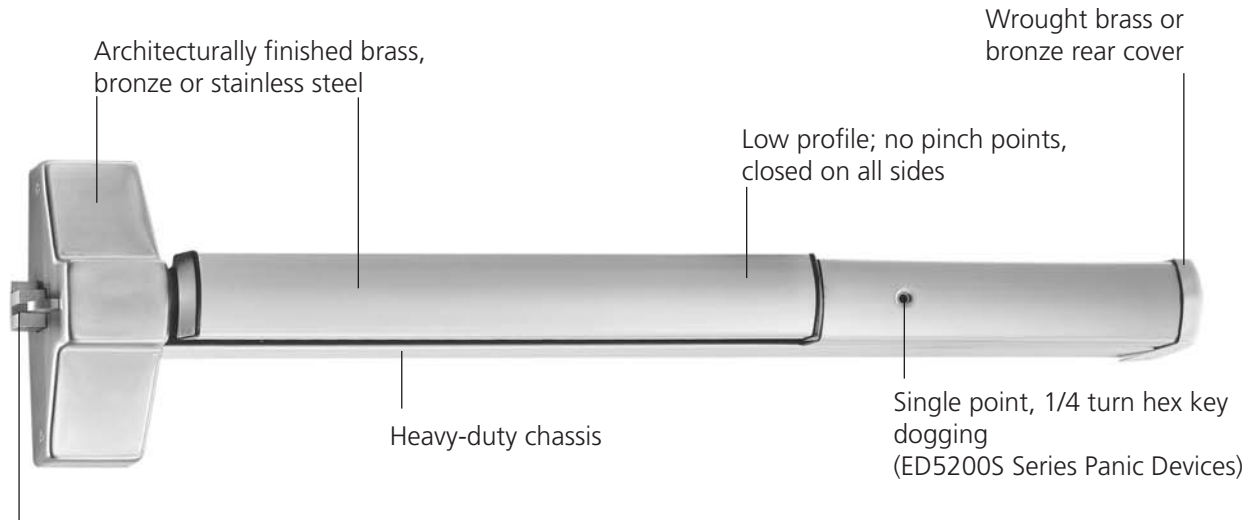

3/4" (19mm) projection x 1" wide deadbolt- style latchbolt with positive deadlocking by auxiliary bolt

In terms of an exit device, vector forces mean that pressure applied to the door results in a force against the stop and the frame, resulting in door/frame separation. The standard pullman latchbolt applies 280 pounds of force against the frame from a 400- pound pull on the door.

The SecureBolt® exit device only applies 63 pounds of force against the frame from a 400-pound pull on the door. Less force means the door and frame do not separate, providing a higher level of security, as the door cannot be pulled open.

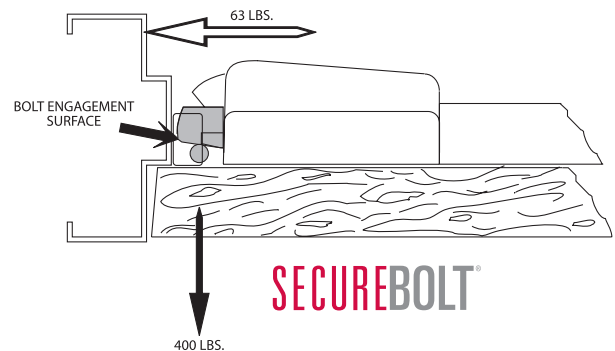
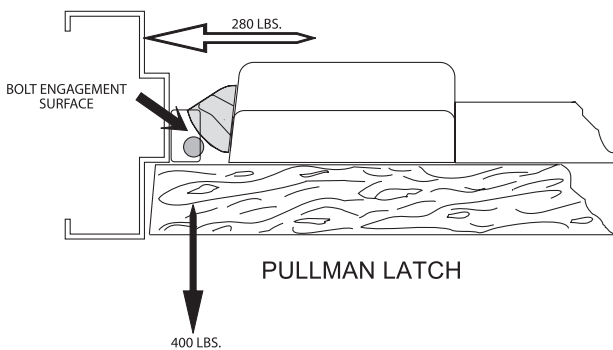
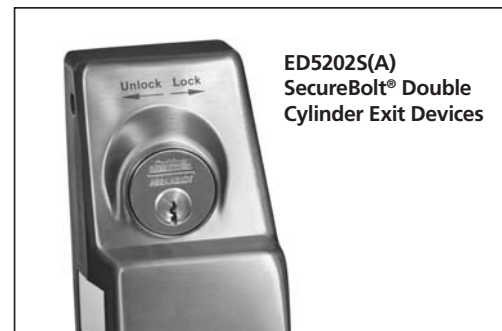

# Rim Features

## ED5000 Series

- ED5200**      **Panic-Listed Rim Exit Device**  
**ED5200A**    **3-Hour Fire-Listed Rim Exit Device**  
**ED5202**      **Panic-Listed Rim Double Cylinder Exit Device**  
**ED5202A**    **3-Hour Fire-Listed Rim Double Cylinder Exit Device**



### Features

#### Handing

Standard device is non-handed.  
 Double Cylinder Device is Handed.  
 Lever trim is handed.

#### Bar Length

Easily field cut to size.  
 Standard: 36" (914mm) bar fits 30" - 36" (762mm-914mm) door.  
 Optional: 24" (610mm) bar fits 24" (610mm) door; specify W024.  
 Optional: 48" (1219mm) bar fits 36" -48" (914mm-1219mm) door; specify W048.

#### Door Thickness

1-3/4" (44mm) standard.  
 Optional: 2" (51mm); specify D200.  
 Optional: 2-1/4" (57mm); specify D214.

#### Stile

Minimum width 4-1/2" (114mm).

#### Latchbolt

3/4" (19mm) throw, stainless steel pullman-type with stainless steel deadlocking latch.

#### Materials

Heavy-duty cold-forged steel chassis; heavy-gauge steel mechanisms, electroplated for corrosion resistance; finished parts are brass, bronze or stainless steel; stainless steel springs; nylon bearings.

#### Projection

3-1/4" (83mm) active, 2-3/4" (70mm) dogged.

#### Dogging

Standard on panic devices; single-point 1/4 turn hex key dogging.  
 Optional: less dogging, specify M51.  
 Optional: cylinder dogging; specify M52.  
 Optional: electric dogging; specify M97.  
 Mechanical dogging not available on fire-rated devices.

#### Fasteners

Standard on panic devices: machine screws and wood door fasteners. Standard on fire-rated devices: sex nuts and bolts. Optional on panic devices: sex nuts and bolts for use on wood, composite, or unreinforced metal doors; specify M54. Optional wood screws for use on approved fire-rated solid wood or wood core doors. Specify M64.

#### Strike

Surface-mounted 3/8" (10mm) diameter roller strike, complete with positive locking plate and shims, assuring low friction relocking for a long, trouble-free life.

#### Functions and Trims

Through-bolted lever, pull and thumbpiece trims available with wide range of functions; see Trims and Functions, pages 28-35.

#### Cylinders

Cylinder not included unless specified. See Quick Codes, page 54.

#### Removable Mullion

See Mullions, page 49.

#### Shim Kit

Optional for mounting device over raised vision light molding; specify M58.

#### Applications and Listings

See page 4.

#### Warranty

Five-year limited.

### Certification/Compliance

#### ANSI

Meets A156.3, Type 1, Grade 1.  
 Meets A117.1 Accessibility Code.

#### UL/cUL

All devices listed for safety as panic hardware; devices comply with UL 305 standards for panic hardware. Three-hour fire-rated devices listed as fire exit hardware for A label and lesser class 4' x 8' single or 8' x 8' double doors; UL symbol on active case cover indicates listing.

Any retrofit or other field modification to a fire rated opening can potentially impact the fire rating of the opening, and Corbin Russwin, Inc. makes no representations or warranties concerning what such impact may be in any specific situation. When retrofitting any portion of an existing fire rated opening, or specifying and installing a new fire-rated opening, please consult with a code specialist or local code official (Authority Having Jurisdiction) to ensure compliance with all applicable codes and ratings.

This product has been approved by the California State Fire Marshal pursuant to section 13144.1 of the California Health and Safety Code.

#### NFPA

All exit devices comply with NFPA 101 Life Safety Code. All fire-rated devices comply with NFPA 80 Fire Doors and Windows.

#### ADA

Exit devices, lever trims and pulls comply with Americans with Disabilities Act.

### Finishes

BHMA 605	Bright Brass
BHMA 606	Satin Brass
BHMA 611	Bright Bronze
BHMA 612	Satin Bronze
BHMA 613	Oxidized Bronze, oil rubbed, available lacquered
613E	Dark Oxidized Satin Bronze Equivalent
BHMA 618	Bright Nickel Plated
BHMA 619	Satin Nickel Plated
BHMA 625	Bright Chromium Plated
BHMA 626 <sup>1</sup> (Trim only)	Satin Chromium Plated
626C <sup>2</sup>	Satin Chromium Plated with MicroShield®
BHMA 629	Bright Stainless Steel
BHMA 630	Satin Stainless Steel
630C <sup>2</sup>	Satin Stainless Steel with MicroShield®
722	Black oxidized bronze, oil rubbed
BSP	Black Suede Powder Coat
WSP	White Suede Powder Coat

1. Contact factory for devices required in BHMA 626
2. Finish available with MicroShield® antimicrobial coating.

### California State Reference Code

Copyright © 2000-2021, ASSA ABLOY Access and Egress Hardware Group, Inc. All rights reserved. Reproduction in whole or in part without the express written permission of ASSA ABLOY Access and Egress Hardware Group, Inc. is prohibited. Patent pending and/or patent www.assaabloyds.com/patents.



# Rim Features

## ED5000 Series

### ED5200 and ED5200A Rim Exit Devices

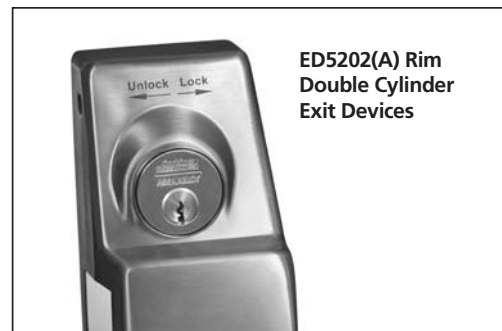
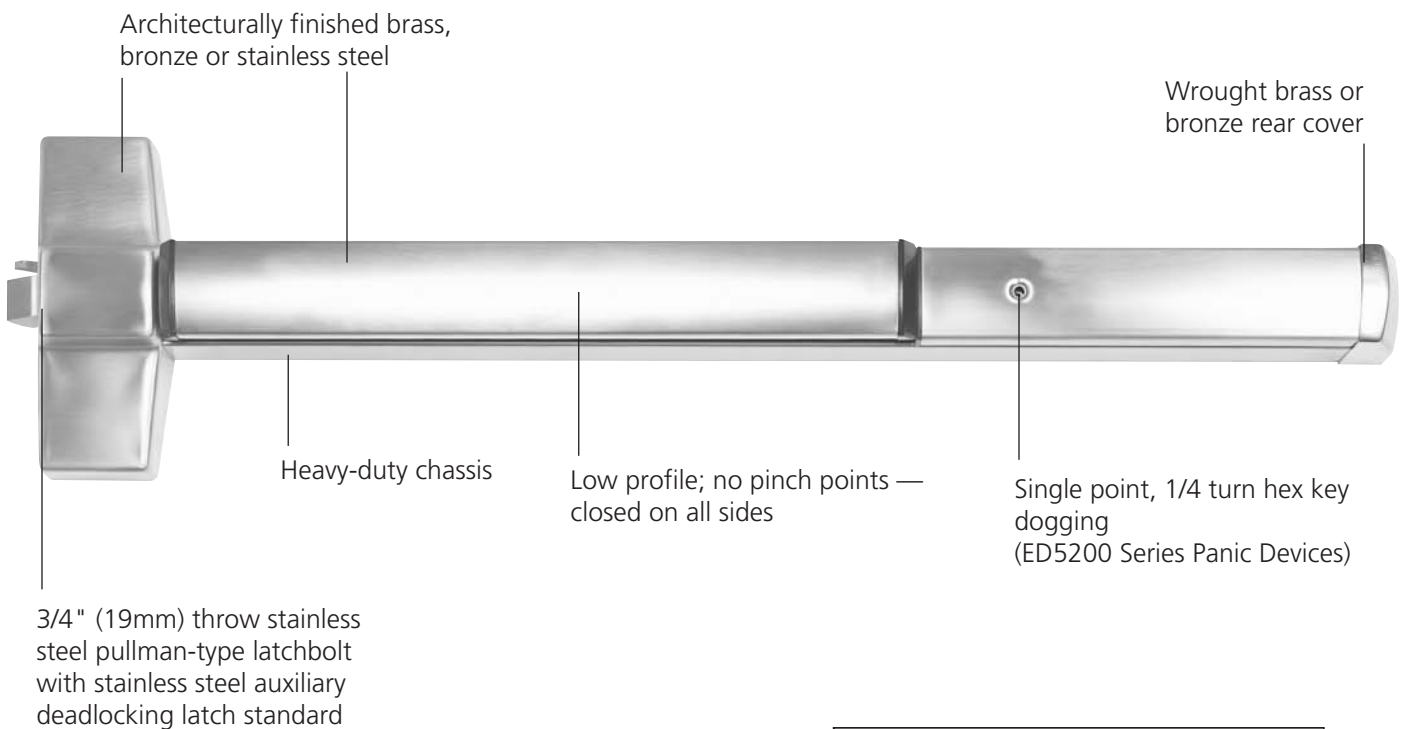

# Surface Vertical Rod Features

## ED5000 Series

### ED5400 Panic-Listed Surface Vertical Rod Exit Device ED5400A 3-Hour Fire-Listed Surface Vertical Rod Exit Device

#### Features

##### Handing

Device is handed but easily field reversible.  
Lever trim is handed.

##### Bar Length

Easily field cut to size.  
Standard: 36" (914mm) bar fits 30" - 36" (762mm-914mm) door.  
Optional: 24" (610mm) bar fits 24" (610mm) door; specify W024.  
Optional: 48" (1219mm) bar fits 36" -48" (914mm-1219mm) door; specify W048.

##### Door Thickness

1-3/4" (44mm) standard.  
Optional: 2" (51mm); specify D200.  
Optional: 2-1/4" (57mm); specify D214.

##### Stile

Minimum width 4-1/2" (114mm).

##### Door Height

Standard top rod for 7' door.  
All rods easily field cut to size.  
Optional door heights up to 8' available; see Quick Codes, page 56.  
For door heights above 8'0" refer to ED5470(B).

##### Latchbolt

Top: 3/4" (19mm) throw, stainless steel pullman-type with automatic deadlatching.  
Bottom: 5/8" (16mm) throw deadbolt, held retracted during door swing.

##### Vertical Rods

1/2" O.D. tubular brass, bronze or stainless steel with rod guides.

##### Materials

Heavy-duty cold-forged steel chassis; heavy-gauge steel mechanisms, electroplated for corrosion resistance; finished parts are brass, bronze or stainless steel; stainless steel springs; nylon bearings.

##### Projection

3-1/4" (83mm) active, 2-3/4" (70mm) dogged.

##### Dogging

Standard on panic devices; single-point 1/4 turn hex key dogging. Optional: less dogging, specify M51. Optional: cylinder dogging, specify M52. Optional: electric dogging; specify M97. Mechanical dogging not available on fire-rated devices.

##### Fasteners

Standard on panic devices: machine screws and wood door fasteners.  
Standard on fire-rated devices: sex nuts and bolts.  
Optional on panic devices: sex nuts and bolts for use on wood, composite, or unreinforced metal doors; specify M54.  
Optional wood screws for use on approved fire-rated solid wood or wood core doors. Specify M64.

##### Strike

Top: adjustable roller strike with positive locking plate and shims.  
Bottom: flush mounted.  
Optional strikes available; see Options and Accessories, page 51.

##### Functions and Trims

Through-bolted lever, pull and thumbpiece trims available with wide range of functions; see Trims and Functions, pages 28-35.

##### Cylinders

Cylinder not included unless specified. See Quick Codes, page 54.

##### Shim Kit

Optional for mounting device over raised vision light molding; specify M58.

##### Applications and Listings

See page 4.

##### Warranty

Five-year limited.

#### Certification/Compliance

##### ANSI

Meets A156.3, Type 2, Grade 1.

##### UL/cUL

All devices listed for safety as panic hardware; devices comply with UL 305 standards for panic hardware. Three-hour fire-rated devices listed as fire exit hardware for A label and lesser class 8' x 8' double doors; UL symbol on active case cover indicates listing.

Any retrofit or other field modification to a fire-rated opening can potentially impact the fire rating of the opening, and Corbin Russwin, Inc. makes no representations or warranties concerning what such impact may be in any

specific situation. When retrofitting any portion of an existing fire rated opening, or specifying and installing a new fire-rated opening, please consult with a code specialist or local code official (Authority Having Jurisdiction) to ensure compliance with all applicable codes and ratings.

##### California State Reference Code

This product has been approved by the California State Fire Marshal pursuant to section 13144.1 of the California Health and Safety Code.

##### NFPA

All exit devices comply with NFPA 101 Life Safety Code. All fire-rated devices comply with NFPA 80 Fire Doors and Windows.

##### ADA

Lever trims and pulls comply with Americans with Disabilities Act.

#### Finishes

BHMA 605	Bright Brass
BHMA 606	Satin Brass
BHMA 611	Bright Bronze
BHMA 612	Satin Bronze
BHMA 613	Oxidized Bronze, oil rubbed, available lacquered
613E	Dark Oxidized Satin Bronze Equivalent
BHMA 618	Bright Nickel Plated
BHMA 619	Satin Nickel Plated
BHMA 625	Bright Chromium Plated
BHMA 626 <sup>1</sup> (Trim only)	Satin Chromium Plated
626C <sup>2</sup>	Satin Chromium Plated with MicroShield®
BHMA 629	Bright Stainless Steel
BHMA 630	Satin Stainless Steel
630C <sup>2</sup>	Satin Stainless Steel with MicroShield®
722	Black oxidized bronze, oil rubbed
BSP	Black Suede Powder
WSP	White Suede Powder Coat

1. Contact factory for devices required in BHMA 626  
2. Finish available with MicroShield® antimicrobial coating.

# Surface Vertical Rod Features

## ED5000 Series

### ED5400 and ED5400A Surface Vertical Rod Exit Device

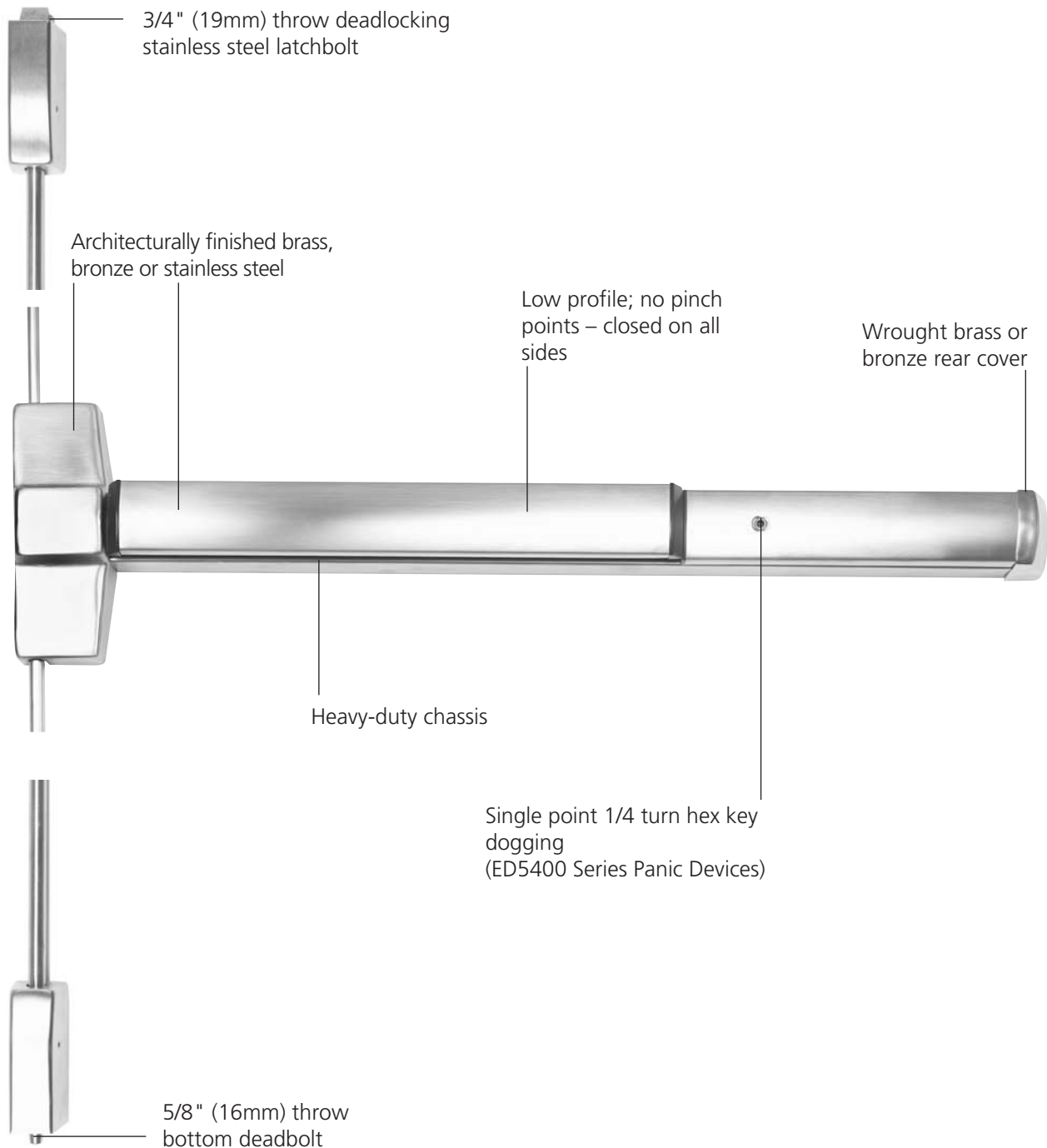

# Surface Vertical Rod Features

## ED5000 Series

### ED5470 Panic-Listed Surface Vertical Rod Exit Device ED5470B 1-1/2 Hour Fire-Listed Surface Vertical Rod Exit Device

#### Features

##### Handing

Device is handed but easily field reversible.  
Lever trim is handed.

##### Bar length

Easily field cut to size.  
Standard: 36" (914mm) bar fits 30" - 36" (762mm-914mm) door.  
Optional: 24" (610mm) bar fits 24" (610mm) door; specify W024.  
Optional: 48" (1219mm) bar fits 36" - 48" (914mm-1219mm) door; specify W048.

##### Door Thickness

1-3/4" (44mm) standard.  
Optional: 2" (51mm); specify D200.  
Optional: 2-1/4" (57mm); specify D214.

##### Stile

Minimum width 4-1/2" (14mm).

##### Door Height

Standard top rod for 7' door.  
All top rods easily field cut to size.  
Optional door heights up to 10' available; see Quick Codes, page 56.

##### Latchbolt

Top: 3/4" (19mm) throw, stainless steel, pullman-type with automatic deadlatching.  
Bottom: 5/8" (16mm) throw deadbolt, held retracted during door swing.

##### Vertical Rods

1/2" O.D. tubular brass, bronze or stainless steel with rod guides.

##### Less Bottom Rod

Optional on ED5470 & ED5470B devices only; specify M55.

##### Heat Activated Door Bolt (Popper)

Standard on all fire-rated devices with M55 option (less bottom rod).

##### Materials

Heavy-duty cold-forged steel chassis; heavy-gauge steel mechanisms, electroplated for corrosion resistance; finished parts are brass, bronze or stainless steel; stainless steel springs; nylon bearings.

##### Projection

3-1/4" (83mm) active, 2-3/4" (70mm) dogged.

##### Dogging

Standard on panic devices; single-point 1/4 turn hex key dogging. Optional: less dogging, specify M51. Optional: cylinder dogging, specify M52. Optional: electric dogging; specify M97. Mechanical dogging not available on fire-rated devices.

##### Fasteners

Standard on panic devices: machine screws and wood door fasteners. Standard on fire-rated devices: sex nuts and bolts. Optional on panic devices: sex nuts and bolts for use on wood, composite, or unreinforced metal doors; specify M54. Optional wood screws for use on approved fire-rated solid wood or wood core doors. Specify M64.

##### Strike

Top: surface mounted interlocking.  
Bottom: flush mounted.  
Optional strikes available; see Options and Accessories, page 51.

##### Functions and Trims

Through-bolted lever, pull and thumbpiece trims available with wide range of functions; see Trims and Functions, pages 28-35.

##### Cylinders

Cylinder not included unless specified. See Quick Codes, page 54.

##### Shim Kit

Optional for mounting device over raised vision light molding; specify M58.

##### Applications and Listings

See page 4.

##### Warranty

Five-year limited.

#### Certification/Compliance

##### ANSI

Meets A156.3, Type 2, Grade 1.  
Meets A117.1 Accessibility Code when ordered with M55 option only.

##### UL/cUL

All devices listed for safety as panic hardware; devices comply with UL 305 standards for panic hardware. 1-1/2 hour fire-rated devices listed as fire exit hardware for B label and lesser class 8' x 10' double doors; UL symbol on active case cover indicates listings.

rated opening can potentially impact the fire rating of the opening, and Corbin Russwin, Inc. makes no representations or warranties concerning what such impact may be in any specific situation. When retrofitting any portion of an existing fire rated opening, or specifying and installing a new fire-rated opening, please consult with a code specialist or local code official (Authority Having Jurisdiction) to ensure compliance with all applicable codes and ratings.

##### California State Reference Code

This product has been approved by the California State Fire Marshal pursuant to section 13144.1 of the California Health and Safety Code.

##### NFPA

All exit devices comply with NFPA 101 Life Safety Code.  
All fire-rated devices comply with NFPA 80 Fire Doors and Windows.

##### ADA

Exit devices with M55 option, lever trims and pulls comply with Americans with Disabilities Act.

#### Finishes

BHMA 605	Bright Brass
BHMA 606	Satin Brass
BHMA 611	Bright Bronze
BHMA 612	Satin Bronze
BHMA 613	Oxidized Bronze, oil rubbed, available lacquered
613E	Dark Oxidized Satin Bronze Equivalent
BHMA 618	Bright Nickel Plated
BHMA 619	Satin Nickel Plated
BHMA 625	Bright Chromium Plated
BHMA 626 <sup>1</sup> (Trim only)	Satin Chromium Plated
626C <sup>2</sup>	Satin Chromium Plated with MicroShield®
BHMA 629	Bright Stainless Steel
BHMA 630	Satin Stainless Steel
630C <sup>2</sup>	Satin Stainless Steel with MicroShield®
722	Black oxidized bronze, oil rubbed
BSP	Black Suede Powder
WSP	White Suede Powder Coat

1. Contact factory for devices required in BHMA 626  
2. Finish available with MicroShield® antimicrobial coating.

# Surface Vertical Rod Features

## ED5000 Series

### ED5470 and ED5470B Surface Vertical Rod Exit Devices

3/4" (19mm) throw deadlocking  
stainless steel latchbolt



Architecturally finished brass,  
bronze or stainless steel



Low profile; no pinch  
points – closed on all  
sides



Wrought brass or  
bronze rear cover

Heavy-duty chassis

Single point 1/4 turn hex key dogging  
(ED5470 Series Panic Devices)

5/8" (16mm) throw  
deadbolt

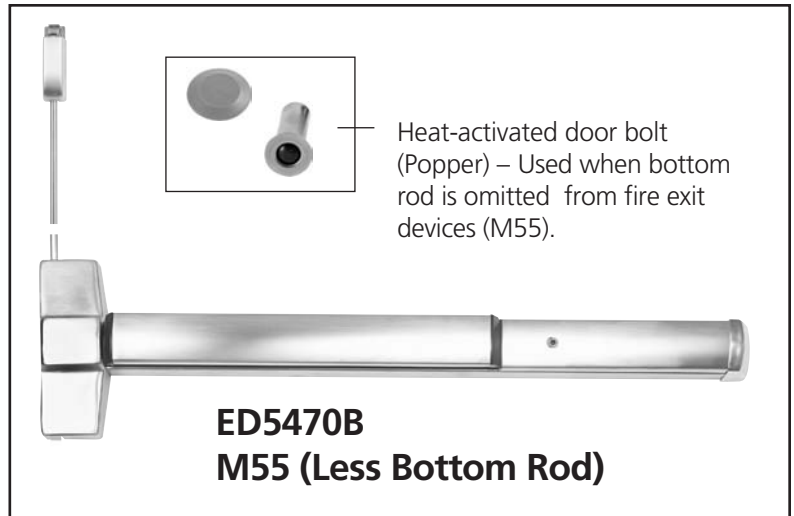



# Concealed Vertical Rod Features

## ED5000 Series



### ED5800 Panic-Listed Concealed Vertical Rod Exit Device ED5800A 3-Hour Fire-Listed Concealed Vertical Rod Exit Device

#### FOR USE WITH METAL DOORS ONLY

#### Features

##### Handing

Device is handed but easily field reversible.  
Lever trim is handed.

##### Bar length

Easily field cut to size.  
Standard: 36" (914mm) bar fits 30" - 36" (762mm-914mm) door.  
Optional: 24" (610mm) bar fits 24" (610mm) door; specify W024.  
Optional: 48" (1219mm) bar fits 36" -48" (914mm-1219mm) door; specify W048.

##### Door Thickness

1-3/4" (44mm) standard.  
Optional: 2" (51mm); specify D200.  
Optional: 2-1/4" (57mm); specify D214.

##### Stile

Minimum width 4-1/2" (114mm).

##### Door Height

Standard: top rod for 8' door.  
Telescoping rod assembly to accommodate various door heights. For door heights above 8'0", refer to ED5860(B).

##### Latchbolt

Top: 3/4" (19mm) throw, stainless steel pullman-type with automatic deadlatching.  
Bottom: 5/8" (16mm) throw deadbolt, held retracted during door swing.

##### Vertical Rods

1/2" O.D. tubing, electroplated for corrosion resistance.

##### Materials

Heavy-duty cold-forged steel chassis; heavy-gauge steel mechanisms, electroplated for corrosion resistance; finished parts are brass, bronze or stainless steel; stainless steel springs; nylon bearings.

##### Projection

3-1/4" (83mm) active, 2-3/4" (70mm) dogged.

##### Dogging

Standard on panic devices; single-point 1/4 turn hex key dogging. Optional: less dogging, specify M51. Optional: cylinder dogging, specify M52. Optional: electric dogging; specify M97. Mechanical dogging not available on fire-rated devices.

##### Fasteners

Standard on panic devices: machine screws.  
Standard on fire-rated devices: sex nuts and bolts.

Optional on panic devices: sex nuts and bolts for use on unreinforced metal doors; specify M54.

##### Strike

Top: roller type.  
Bottom: flush mounted.  
Optional strikes available; see Options and Accessories, page 51.

##### Functions and Trims

Through-bolted lever, pull and thumbpiece trims available with wide range of functions; see Trims and Functions, pages 28-35.

##### Cylinders

Cylinder not included unless specified. See Quick Codes, page 54.

##### Shim Kit

Optional for mounting device over raised vision light molding; specify M58.

##### Applications and Listings

For use on metal doors only. See page 4.

##### Warranty

Five-year limited.

##### Certification/Compliance

###### ANSI

Meets A156.3, Type 8, Grade 1.  
Meets A117.1 Accessibility Code.

###### UL/cUL

All devices listed for safety as panic hardware; devices comply with UL 305 standards for panic hardware. Three-hour fire-rated devices listed as fire exit hardware for A label and lesser class 8' x 8' double doors; UL symbol on active case cover indicates listing.

Any retrofit or other field modification to a fire rated opening can potentially impact the fire rating of the opening, and Corbin Russwin, Inc. makes no representations or warranties concerning what such impact may be in any specific situation. When retrofitting any portion of an existing fire rated opening, or specifying and installing a new fire-rated opening, please consult with a code specialist or local code

official (Authority Having Jurisdiction) to ensure compliance with all applicable codes and ratings.

##### California State Reference Code

This product has been approved by the California State Fire Marshal pursuant to section 13144.1 of the California Health and Safety Code.

##### NFPA

All exit devices comply with NFPA 101 Life Safety Code.

All fire-rated devices comply with NFPA 80 Fire Doors and Windows.

##### ADA

Exit devices, lever trims and pulls comply with Americans with Disabilities Act.

##### Finishes

BHMA 605	Bright Brass
BHMA 606	Satin Brass
BHMA 611	Bright Bronze
BHMA 612	Satin Bronze
BHMA 613	Oxidized Bronze, oil rubbed, available lacquered
613E	Dark Oxidized Satin Bronze Equivalent
BHMA 618	Bright Nickel Plated
BHMA 619	Satin Nickel Plated
BHMA 625	Bright Chromium Plated
BHMA 626 <sup>1</sup> (Trim only)	Satin Chromium Plated
626C <sup>2</sup>	Satin Chromium Plated with MicroShield®
BHMA 629	Bright Stainless Steel
BHMA 630	Satin Stainless Steel
630C <sup>2</sup>	Satin Stainless Steel with MicroShield®
722	Black oxidized bronze, oil rubbed
BSP	Black Suede Powder
WSP	White Suede Powder Coat

1. Contact factory for devices required in BHMA 626
2. Finish available with MicroShield® antimicrobial coating.

# Concealed Vertical Rod Features

ED5000 Series

## ED5800 and ED5800A Concealed Vertical Rod Exit Devices

FOR USE WITH METAL DOORS ONLY

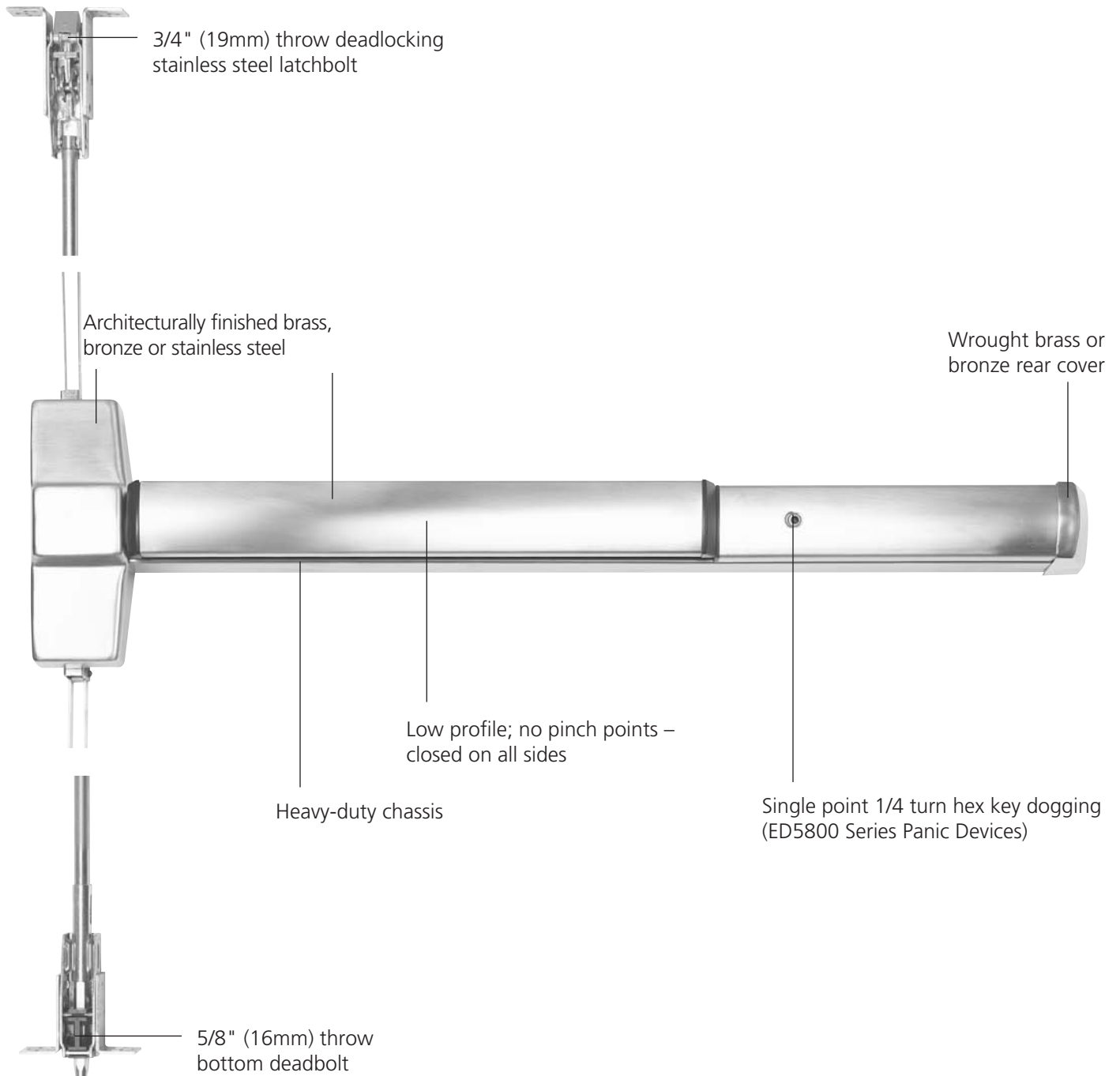

# Concealed Vertical Rod Features

## ED5000 Series



### ED5860 Panic-Listed Concealed Vertical Rod Exit Device ED5860B 1-1/2 Hour Fire-Listed Concealed Vertical Rod Exit Device

#### FOR USE WITH METAL OR WOOD DOORS

#### Features

##### Handing

Device is handed but is easily field reversible.  
Lever trim is handed.

##### Bar length

Easily field cut to size.  
Standard: 36" (914mm) bar fits 30" - 36" (762mm-914mm) door.  
Optional: 24" (610mm) bar fits 24" (610mm) door; specify W024.  
Optional: 48" (1219mm) bar fits 36" -48" (914mm-1219mm) door; specify W048.

##### Door Thickness

1-3/4" (14mm) standard.  
Optional: 2" (51mm); specify D200.  
Optional: 2-1/4" (57mm); specify D214.

##### Stile

Minimum width 4-1/2" (114mm).

##### Door Height

Standard: top rod for 8' door.  
Telescoping rod assembly to accommodate various door heights.  
Optional door heights up to 10' available; see Quick Codes, page 56.

##### Latchbolt

Top: 3/4" (19mm) throw, stainless steel, pullman-type with automatic deadlatching.  
Bottom: 5/8" (16mm) throw deadbolt, held retracted during door swing.

##### Vertical Rods

1/2" O.D. tubing, electroplated for corrosion resistance.

##### Less Bottom Rod

Optional on ED5860 and ED5860B devices only; specify M55.

##### Heat-Activated Door Bolt (Popper)

Standard with all fire-rated devices with M55 option (less bottom rod).

##### Materials

Heavy-duty cold-forged steel chassis; heavy-gauge steel mechanisms, electroplated for corrosion resistance; finished parts are brass, bronze or stainless steel; stainless steel springs; nylon bearings.

##### Projection

3-1/4" (83mm) active, 2-3/4" (70mm) dogged.

##### Dogging

Standard on panic devices; single-point 1/4 turn hex key dogging.  
Optional: less dogging, specify M51.  
Optional: cylinder dogging, specify M52.  
Optional: electric dogging; specify M97.  
Mechanical dogging not available on fire-rated devices.

##### Fasteners

Standard on panic devices: machine screws and wood door fasteners.  
Standard on fire-rated devices: sex nuts and bolts.  
Optional on panic devices: sex nuts and bolts for use on wood, composite, or unreinforced metal doors; specify M54.  
Optional wood screws for use on approved fire-rated solid wood or wood core doors. Specify M64.

##### Strike

Top: mortise. Bottom: flush mounted.  
Optional strikes available; see Options and Accessories, page 51.

##### Functions and Trims

Through-bolted lever, pull and thumbpiece trims available with wide range of functions; see Trims and Functions, pages 28-35.

##### Cylinders

Cylinder not included unless specified. See Quick Codes, page 54.

##### Shim Kit

Optional for mounting device over raised vision light molding; specify M58.

##### Applications and Listings

For use with metal or wood doors. See page 4.

##### Warranty

Five-year limited.

#### Certification/Compliance

##### ANSI

Meets A156.3, Type 7 and 8, Grade 1.  
Meets A117.1 Accessibility Code.

##### UL/cUL

All devices listed for safety as panic hardware; devices comply with UL 305 standards for panic hardware. 1-1/2 hour fire-rated devices listed as fire exit hardware for B label and lesser class 8' x 10' double doors; UL symbol on active case cover indicates listings.  
Any retrofit or other field modification to a fire rated opening can potentially impact the fire

rating of the opening, and Corbin Russwin, Inc. makes no representations or warranties concerning what such impact may be in any specific situation. When retrofitting any portion of an existing fire rated opening, or specifying and installing a new fire-rated opening, please consult with a code specialist or local code official (Authority Having Jurisdiction) to ensure compliance with all applicable codes and ratings.

##### California State Reference Code

This product has been approved by the California State Fire Marshal pursuant to section 13144.1 of the California Health and Safety Code.

##### NFPA

All exit devices comply with NFPA 101 Life Safety Code.

All fire-rated devices comply with NFPA 80 Fire Doors and Windows.

##### ADA

Exit devices, lever trims and pulls comply with Americans with Disabilities Act.

#### Finishes

BHMA 605	Bright Brass
BHMA 606	Satin Brass
BHMA 611	Bright Bronze
BHMA 612	Satin Bronze
BHMA 613	Oxidized Bronze, oil rubbed, available lacquered
613E	Dark Oxidized Satin Bronze Equivalent
BHMA 618	Bright Nickel Plated
BHMA 619	Satin Nickel Plated
BHMA 625	Bright Chromium Plated
BHMA 626 <sup>1</sup> (Trim only)	Satin Chromium Plated
626C <sup>2</sup>	Satin Chromium Plated with MicroShield®
BHMA 629	Bright Stainless Steel
BHMA 630	Satin Stainless Steel
630C <sup>2</sup>	Satin Stainless Steel with MicroShield®
722	Black oxidized bronze, oil rubbed
BSP	Black Suede Powder
WSP	White Suede Powder Coat

1. Contact factory for devices required in BHMA 626
2. Finish available with MicroShield® antimicrobial coating.

# Concealed Vertical Rod Features

## ED5000 Series

### ED5860 and ED5860B Concealed Vertical Rod Exit Devices

FOR USE WITH METAL OR  
WOOD DOORS

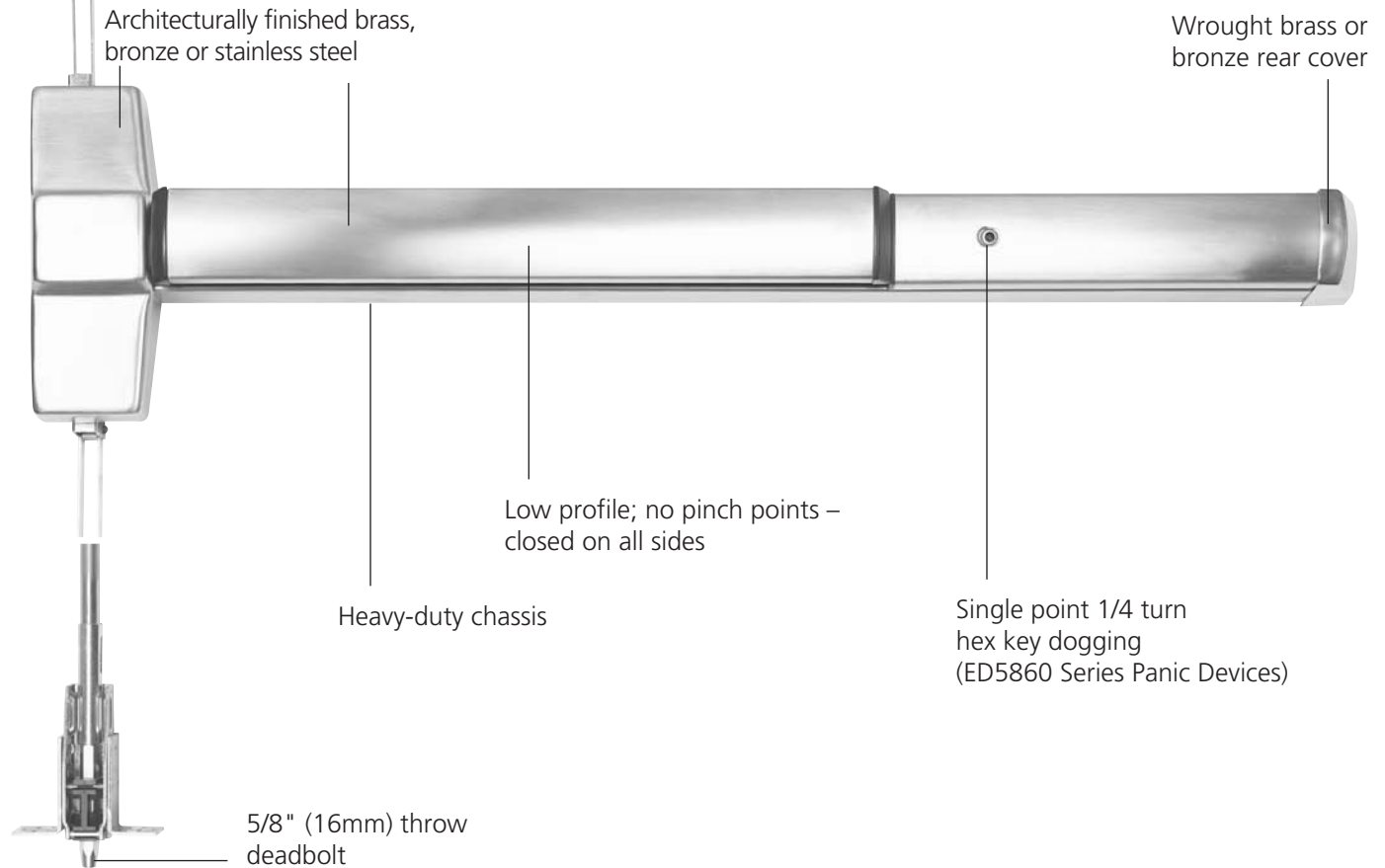
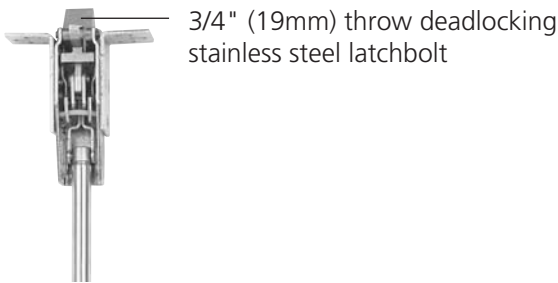
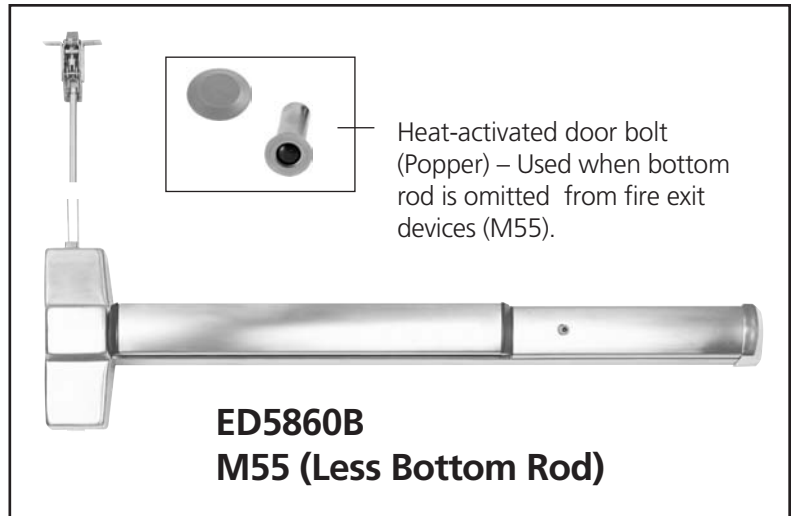

# Functions

## ED5000 Series

### Pull and Thumbpiece Trim

Rim/ SecureBolt® ED5200(A) ED5200S(A)		Surface Vertical Rod ED5400(A) ED5470(B)		Concealed Vertical Rod ED5800(A) ED5860(B)		Type	ANSI No.	Function Description
Inside	Outside	Inside	Outside	Inside	Outside			
						<b>Exit Only</b>	01	Exit only; no trim.
						<b>Dummy</b>	02	Entrance by trim when actuating bar is dogged down.
						<b>Nightlatch</b>	03	Entrance by trim when latchbolt is retracted by key.
						<b>Classroom*</b>	05	Entrance by thumbpiece. Key locks or unlocks thumbpiece.
						<b>Passage</b>	15	Entrance by trim when latch is retracted by thumbpiece. Thumbpiece is always active, no cylinder.
						<b>Storeroom (Thumbpiece Active)</b>	06	Entrance by thumbpiece only when released by key. Key removable only when locked.











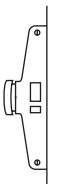

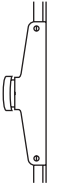









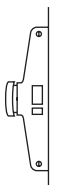

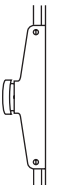
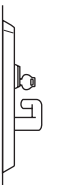

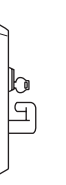





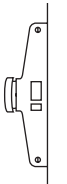

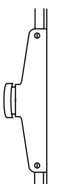
\*Classroom function trims can be converted to Storeroom function by a simple field adjustment.



# Functions

## ED5000 Series

### Lever Trim

Rim/ SecureBolt® ED5200(A) ED5200S(A)		Surface Vertical Rod ED5400(A) ED5470(B)		Concealed Vertical Rod ED5800(A) ED5860(B)		Type	ANSI No.	Function Description
Inside	Outside	Inside	Outside	Inside	Outside			
						<b>Exit Only</b>	01	Exit only; no trim.
						<b>Dummy</b>	02	Entrance by trim when actuating bar is dogged down.
						<b>Nightlatch</b>	03	Entrance by trim when latchbolt is retracted by key.
						<b>Classroom*</b>	08	Entrance by lever. Key locks or unlocks lever.
						<b>Passage</b>	14	Entrance by trim when latchbolt is retracted by lever. Lever always active, no cylinder.
						<b>Storeroom (Grip Active)</b>	09	Entrance by lever only when released by key. Key removable only when locked.

\*Classroom function trims can be converted to Storeroom function by a simple field adjustment.

# Heavy-Duty Trims & Functions









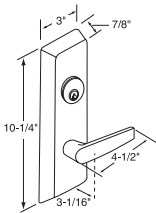

## ED5000 Series

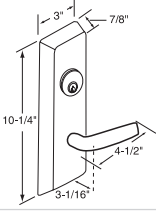
### Rim, SecureBolt®, Vertical Rod

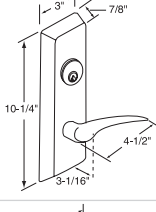
#### Features:

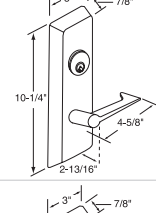
- Free Wheeling vandal-resistant design
- Beveled edges

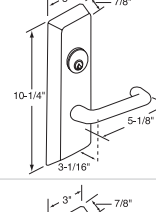
- Through-bolted to exit device
- Flush cylinder with 6-pin cylinder applications
- 5-year limited warranty

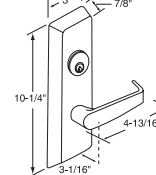
Pull Trim Design	Trim/Function				
	Passage ANSI No. 14	Dummy ANSI No. 02	Classroom ANSI No. 08	Nightlatch ANSI No. 03	Storeroom ANSI No. 09
 <p><b>Armstrong A9</b> Lever: Cast Escutcheon: Forged Cylinder: Rim</p> 	A910ET	A950ET	A955ET <sup>1</sup>	A957ET <sup>2</sup>	A959ET <sup>1</sup>
 <p><b>Citation C9</b> Lever: Cast Escutcheon: Forged Cylinder: Rim</p> 	C910ET	C950ET	C955ET <sup>1</sup>	C957ET <sup>2</sup>	C959ET <sup>1</sup>
 <p><b>Dirke D9</b> Lever: Cast Escutcheon: Forged Cylinder: Rim Handed: Specify RHR or LHR</p> 	D910ET	D950ET	D955ET <sup>1</sup>	D957ET <sup>2</sup>	D959ET <sup>1</sup>
 <p><b>Essex E9</b> Lever: Cast Escutcheon: Forged Cylinder: Rim</p> 	E910ET	E950ET	E955ET <sup>1</sup>	E957ET <sup>2</sup>	E959ET <sup>1</sup>
 <p><b>Lustra L9</b> Lever: Cast Escutcheon: Forged Cylinder: Rim</p> 	L910ET	L950ET	L955ET <sup>1</sup>	L957ET <sup>2</sup>	L959ET <sup>1</sup>
 <p><b>Newport N9</b> Lever: Cast Escutcheon: Forged Cylinder: Rim</p> 	N910ET	N950ET	N955ET <sup>1</sup>	N957ET <sup>2</sup>	N959ET <sup>1</sup>

1. Classroom function trims can be converted to Storeroom function by a simple field adjustment.

2. Not recommended for use on ED5400 or ED5800 series exit devices.

# Heavy-Duty Trims & Functions







## ED5000 Series

### Rim, SecureBolt®, Vertical Rod

#### Features:

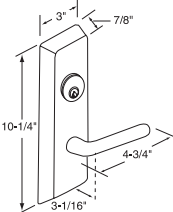
- Free Wheeling vandal-resistant design
- Beveled edges

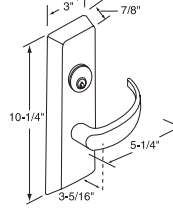
- Through-bolted to exit device
- Flush cylinder with 6-pin cylinder applications
- 5-year limited warranty

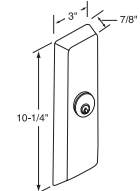
Pull Trim Design			Trim/Function					
			Passage ANSI No. 14	Dummy ANSI No. 02	Classroom ANSI No. 08	Nightlatch ANSI No. 03	Storeroom ANSI No. 09	
	<b>Regis R9</b> Lever: Cast Escutcheon: Forged Cylinder: Rim			R910ET	R950ET	R955ET <sup>1</sup>	R957ET <sup>2</sup>	R959ET <sup>1</sup>
	<b>Princeton PR9</b> Lever: Cast Escutcheon: Forged Cylinder: Rim			PR910ET	PR950ET	PR955ET <sup>1</sup>	PR957ET <sup>2</sup>	PR959ET <sup>1</sup>
	<b>Escutcheon F9</b> Escutcheon: Forged Cylinder: Rim			N/A	F950ET	N/A	F957ET <sup>2</sup>	N/A

1. Classroom function trims can be converted to Storeroom function by a simple field adjustment.

2. Not recommended for use on ED5400 or ED5800 series exit devices.

# Utility Trims and Functions







## ED5000 Series

### Rim, SecureBolt®, Vertical Rod

#### Features:

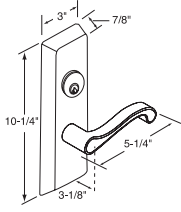
- Free Wheeling vandal-resistant design
- Beveled edges

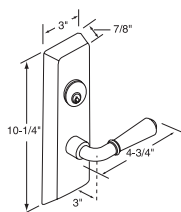
- Through-bolted to exit device
- Flush cylinder with 6-pin cylinder applications
- 5-year limited warranty

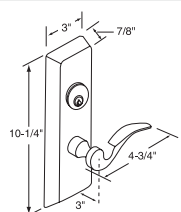
Pull Trim Design			Trim/Function					
			Passage ANSI No. 14	Dummy ANSI No. 02	Classroom ANSI No. 08	Nightlatch ANSI No. 03	Storeroom ANSI No. 09	
	<b>Frascati FR9</b> Lever: Cast Escutcheon: Forged Cylinder: Rim Handed: Specify RHR or LHR			FR910ET	FR950ET	FR955ET <sup>1</sup>	FR957ET <sup>2</sup>	FR959ET
	<b>Merlot M9</b> Lever: Cast Escutcheon: Forged Cylinder: Rim			M910ET	M950ET	M955ET <sup>1</sup>	M957ET <sup>2</sup>	M959ET
	<b>Zinfandel Z9</b> Lever: Cast Escutcheon: Forged Cylinder: Rim Handed: Specify RHR or LHR			Z910ET	Z950ET	Z955ET <sup>1</sup>	Z957ET <sup>2</sup>	Z959ET

1. Classroom function trims can be converted to Storeroom function by a simple field adjustment.
2. Not recommended for use on ED5400 or ED5800 series exit devices.

# Utility Trims and Functions







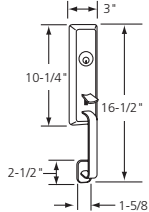

## ED5000 Series

### Rim, SecureBolt®, Vertical Rod

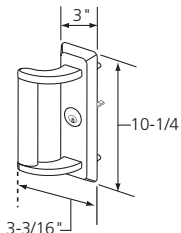
#### Features:

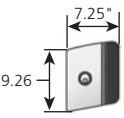
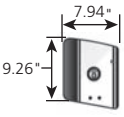
- Free Wheeling vandal-resistant design
- Beveled edges

- Through-bolted to exit device
- Flush cylinder with 6-pin cylinder applications
- 5-year limited warranty

Pull Trim Design		Trim/Function					
		Passage ANSI No. 14/15	Dummy ANSI No. 02	Classroom ANSI No. 05/08	Nightlatch ANSI No. 03	Storeroom ANSI No. 06/09	
	<b>TH900 Trim</b> Pull: Extruded Escutcheon: Forged Cylinder: Rim Projection: 2-11/16"		TH910ET	TH950ET	TH955ET <sup>1</sup>	TH957ET <sup>2</sup>	TH959ET <sup>1</sup>
	<b>Offset Pull P9</b>  Pull: Extruded Escutcheon: Forged Cylinder: Rim Handed. Specify RHR or LHR		N/A	P950ET	N/A	P957ET <sup>2</sup>	N/A
	<b>VT9 Trim</b>  Plate: Formed Stainless Steel Cylinder: Rim Handed: Specify RHR or LHR Available in 630 finish only.		N/A	VT950ET	N/A	VT957ET <sup>2</sup>	N/A
			N/A	VTL950ET <sup>3</sup>	N/A	VTL957ET <sup>2,3</sup>	N/A
	<b>Key Only K1²</b>  Note: Available with cylinder option only. Ex: K157 x 6P.		N/A	N/A	N/A	K157ET <sup>2,4</sup>	N/A



1. Classroom function trims can be converted to Storeroom function by a simple field adjustment.
2. Not recommended for use on ED5400 or ED5800 series exit devices.
3. VTL has a lip that covers door gap and protects the latch.
4. Not available in 625 or 626 finish. Supplied in 629 or 630 respectively.



# Utility Trims and Functions

## ED5000 Series

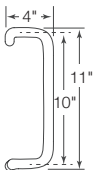
### Offset Pull Trim: P12, P13, P14\*

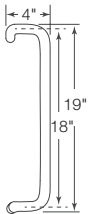
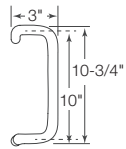
	<p><b>Offset Pull P12</b> Clearance: 2-1/2" </p>		<p>Specify Part Number, 716F50M x Finish<sup>1</sup></p>
	<p><b>Offset Pull P13</b> Clearance: 2-1/2" </p>		<p>Specify Part Number, 716F51M x Finish<sup>1</sup></p>
	<p><b>Offset Pull P14</b> Clearance: 2-1/2" </p>		<p>Specify Part Number, 716F52M x Finish<sup>1</sup></p>

1. Available in 605, 606, 612, 613, 626, 629 and 630 finishes.  
\*Available on 1-3/4" thick doors only.

# Utility Trims and Functions

## ED5000 Series

### Rim, SecureBolt®, Vertical Rod Features:

- Free Wheeling vandal-resistant design
- Beveled edges
- Through-bolted to exit device
- Flush cylinder with 6-pin cylinder applications
- 5-year limited warranty



Lever: Cast  
Escutcheon: Forged  
Cylinder: Rim

Lever Designs (Choose from list below)	Functions					How to Order Example: Trim x Function # 102910			
	Passage ANSI No. 14 Function #910	Dummy ANSI No. 02 Function #950	Classroom ANSI No. 08 Function #955	Nightlatch ANSI No. 03 Function #957	Storeroom ANSI No. 09 Function #959				
<b>Muséo®</b>									
<b>Georgia</b>									
	101 <sup>4</sup>	102	103	104 <sup>4</sup>	124 <sup>2</sup>	125 <sup>2</sup>			
<b>Salvador</b>									
	106	107	108	109	110	123 <sup>2</sup>	128 <sup>2</sup>		
<b>Marc</b>									
	111 <sup>4</sup>	112 <sup>4</sup>	113 <sup>4</sup>	114 <sup>4</sup>	115 <sup>4</sup>	116 <sup>4</sup>	130 <sup>2,4</sup>	131 <sup>2,4</sup>	132 <sup>2,4</sup>
<b>Jackson</b>									
	105 <sup>4</sup>	117 <sup>4</sup>	119 <sup>4</sup>	121 <sup>4</sup>	122 <sup>4</sup>	126 <sup>2,4</sup>	127 <sup>2,4</sup>		
<b>Piet**</b>									
	21G	21L	21M	21S	23M	25M	27M		
<b>Joseph<sup>3</sup></b>									
	133	134 <sup>2</sup>	135	136 <sup>2</sup>	137	138 <sup>2</sup>			
<b>Georges</b>									
	139	140	141	142	143				
<b>Laszlo</b>									
	147	148	149	150					

\*See pages 60 for how to order the Muséo® Piet Lever Collection.  
 1. Classroom function trims can be converted to Storeroom function by a simple field adjustment.  
 2. Complies with codes requiring lever to return to within 1/2" (13mm) of door face.  
 3. 135-138 contain white or back polycarbonate insert  
 4. Not available in 32D or 32 finish

# Mortise Features

## ED5000 Series

- ED5600**      **Panic-Listed Mortise Exit Device**  
**ED5600A**    **3-Hour Fire-Listed Mortise Exit Device**  
**ED5602L**    **Panic-Listed Mortise Double Cylinder Exit Device**  
**ED5602AL**   **3-Hour Fire-Listed Mortise Double Cylinder Exit Device**



### Features

#### Handing

Device is non-handed.  
Mortise lock body is handed, but field reversible.  
Lever trim may be handed.

#### Bar length

Easily field cut to size.  
Standard: 36" (914mm) bar fits 30" - 36" (762mm-914mm) door.  
Optional: 24" (610mm) bar fits 24" (610mm) door; specify W024.  
Optional: 48" (1219mm) bar fits 36" -48" (914mm-1219mm) door; specify W048.

#### Door Thickness

1-3/4" (44mm) standard.  
Optional: 2" (51mm); specify D200.  
Optional: 2-1/4" (57mm); specify D214.

#### Stile

Minimum width 4-1/2" (114mm).

#### Latchbolt

2-piece mechanical, 3/4" (19mm) throw, stainless steel with auxiliary deadlocking latch.

#### Materials

Heavy-duty cold-forged steel chassis; heavy-gauge steel mechanisms, electroplated for corrosion resistance; finished parts are brass, bronze or stainless steel; stainless steel springs; nylon bearings.

#### Projection

3-1/4" (83mm) active, 2-3/4" (70mm) dogged.

#### Dogging

Standard on panic devices; single-point 1/4 turn hex key dogging.  
Optional: less dogging, specify M51.  
Optional: cylinder dogging, specify M52.  
Optional: electric dogging; specify M97.  
Mechanical dogging not available on fire-rated devices.

#### Fasteners

Standard on panic devices: machine screws and wood door fasteners.  
Standard on fire-rated devices: sex nuts and bolts.  
Optional on panic devices: sex nuts and bolts for use on wood, composite, or unreinforced metal doors; specify M54.  
Optional wood screws for use on approved fire-rated solid wood or wood core doors. Specify M64.

#### Strike

Non-handed. ANSI curved lip standard. 4-7/8" x 1-1/4" x 1-1/4" lip to center.  
Optional strikes available; see Options and Accessories, page 51.

#### Functions and Trims

Through-bolted lever, pull and thumbpiece trims available with wide range of functions; see Trims and Functions, pages 28-35.

#### Cylinders

Cylinder not included unless specified. See Quick Codes, page 54.

#### Shim Kit

Optional for mounting device over raised vision light molding; specify M58.

#### Applications and Listings

See page 4.

#### Warranty

Five-year limited.

### Certification/Compliance

#### ANSI

Meets A156.3, Type 3, Grade 1.  
Meets A117.1 Accessibility Code.

#### UL/CUL

All devices listed for safety as panic hardware; devices comply with UL 305 standards for panic hardware. Three-hour fire-rated devices listed as fire exit hardware for A label and lesser class 4' x 8' single or 8' x 8' double doors; UL symbol on active case cover indicates listings.

rating of the opening, and Corbin Russwin, Inc. makes no representations or warranties concerning what such impact may be in any specific situation. When retrofitting any portion of an existing fire rated opening, or specifying and installing a new fire-rated opening, please consult with a code specialist or local code official (Authority Having Jurisdiction) to ensure compliance with all applicable codes and ratings.

#### California State Reference Code

This product has been approved by the California State Fire Marshal pursuant to section 13144.1 of the California Health and Safety Code.

#### NFPA

All exit devices comply with NFPA 101 Life Safety Code.

All fire-rated devices comply with NFPA 80 Fire Doors and Windows.

#### ADA

Exit devices, lever trims and pulls comply with Americans with Disabilities Act.

### Finishes

BHMA 605	Bright Brass
BHMA 606	Satin Brass
BHMA 611	Bright Bronze
BHMA 612	Satin Bronze
BHMA 613	Oxidized Bronze, oil rubbed, available lacquered
613E	Dark Oxidized Satin Bronze Equivalent
BHMA 618	Bright Nickel Plated
BHMA 619	Satin Nickel Plated
BHMA 625	Bright Chromium Plated
BHMA 626 <sup>1</sup> (Trim only)	Satin Chromium Plated
626C <sup>2</sup>	Satin Chromium Plated with MicroShield®
BHMA 629	Bright Stainless Steel
BHMA 630	Satin Stainless Steel
630C <sup>2</sup>	Satin Stainless Steel with MicroShield®
722	Black oxidized bronze, oil rubbed
BSP	Black Suede Powder
WSP	White Suede Powder Coat

**1. Contact factory for devices required in BHMA 626**

**2. Finish available with MicroShield® antimicrobial coating.**

# Mortise Features

## ED5000 Series

**ED5600K, ED5657K, ED5600L,  
ED5602L, ED5657L,  
ED5600T, ED5657T  
Mortise Panic-Listed Exit Devices**

**ED5600AK, ED5657AK, ED5600AL,  
ED5602AL, ED5657AL  
ED5600AT, ED5657AT  
Mortise Fire-Listed Exit Devices**

### How to Order/Specify Mortise Exit

Trim Type	Functions	Panic	Fire
Lever or Flat Plate	Passage	ED5600L	ED5600AL
	Classroom		
	Double Cylinder (Classroom function Trim only)	ED5602L	ED5602AL
Thumbpiece	Nightlatch Dummy	ED5657L	ED5657AL
	Passage Classroom	ED5600T	ED5600AT
Nightlatch			
Dummy	ED5657T		

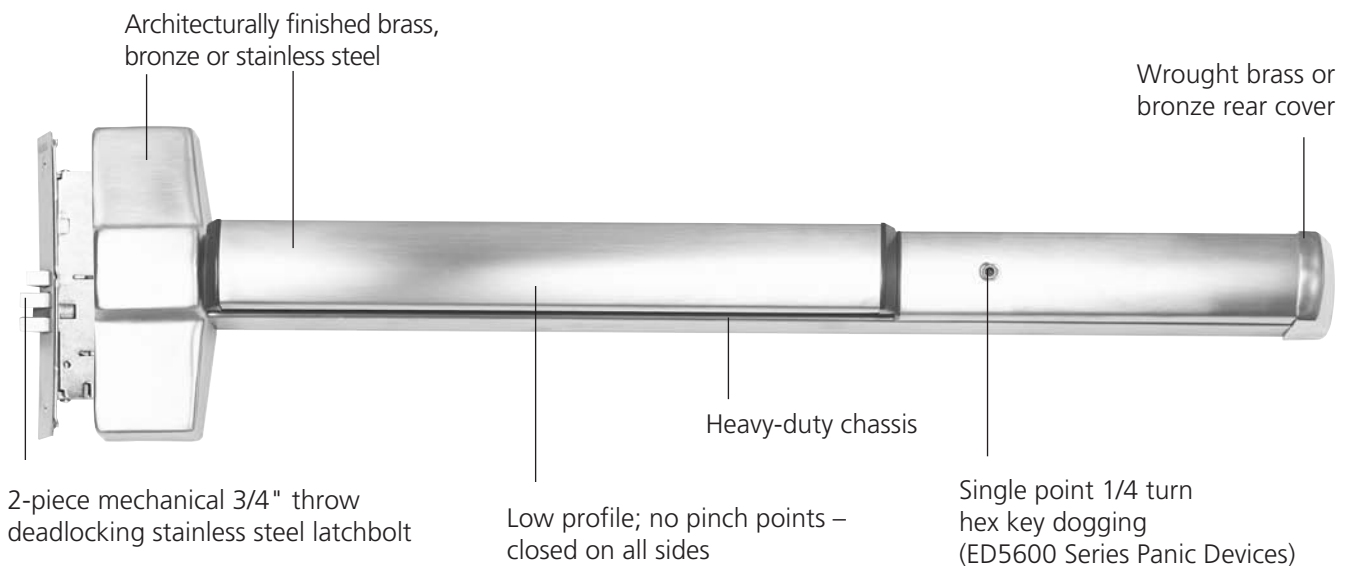

# Mortise Functions

## ED5000 Series

### Exit Only, Pull and Thumbpiece Trim

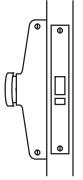
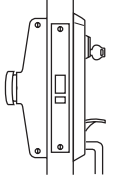
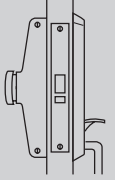
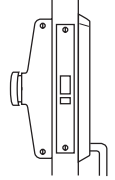
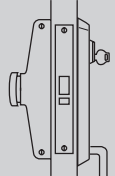
Mortise ED5600L ED5600AL		Type	ANSI No.	Function Description
Inside	Outside			
		<b>Exit Only</b>	01	Exit only; no trim.
Mortise ED5600T ED5600AT		Type	ANSI No.	Function Description
Inside	Outside			
		<b>Classroom</b>	05	Entrance by thumbpiece. Key locks or unlocks thumbpiece. Specify Thumbpiece - ED5600T or ED5600AT.
		<b>Passage</b>	15	Entrance by trim when latch is retracted by thumbpiece. Thumbpiece always active, no cylinder. Specify Thumbpiece - ED5600T or ED5600AT.
Mortise ED5657T ED5657AT		Type	ANSI No.	Function Description
Inside	Outside			
		<b>Dummy</b>	02	Entrance by trim when actuating bar is dogged down. Specify ED5657T or ED5657AT.
		<b>Nightlatch</b>	03	Entrance by trim when latchbolt is retracted by key. Key removable only when locked. Specify ED5657T or ED5657AT.



# Mortise Functions

## ED5000 Series

### Lever Trim

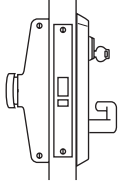
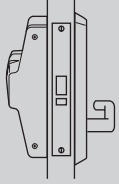
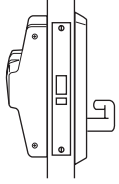
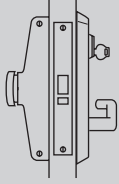
Mortise ED5600L ED5600AL ED5600K ED5600AK Inside    Outside	Type	ANSI No.	Function Description
	<b>Classroom**</b>	08	Entrance by lever. Key locks or unlocks lever.
	<b>Passage*</b>	14	Entrance by trim when latchbolt is retracted by lever. Lever always active, no cylinder. Specify K, AK, L or AL.
Mortise ED5657L ED5657AL ED5657K ED5657AK Inside    Outside	Type	ANSI No.	Function Description
	<b>Dummy*</b>	02	Entrance by trim when actuating bar is dogged down.
	<b>Nightlatch**</b>	03	Entrance by trim when latchbolt is retracted by key. Key removable only when locked. Specify ED5657L, ED5657AL, ED5657K, ED5657AK.

\*Dummy and passage function trims are the same.

\*\*Classroom and Nightlatch function trims are the same. Trim function must be specified when ordered with an exit to ensure that the correct lock body is supplied with the device.

# Heavy-Duty Mortise Trims & Functions

## ED5000 Series

### Features:

- Beveled edges
- Rigid lever when locked
- Flush cylinder
- Through-bolted to exit device
- 5-year limited warranty

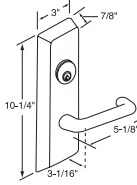







Trim Design	Trim/Function			
	Passage ANSI No. 14	Dummy ANSI No. 02	Classroom ANSI No. 08	Nightlatch ANSI No. 03
 <p><b>Armstrong A9M</b> Lever: Cast Escutcheon: Forged Cylinder: 1-3/4" Mortise A02</p>  	A9M10	A9M50	A9M55	A9M57
 <p><b>Citation C9M</b> Lever: Cast Escutcheon: Forged Cylinder: 1-3/4" Mortise A02</p>  	C9M10	C9M50	C9M55	C9M57
 <p><b>Dirke D9M</b> Lever: Cast Escutcheon: Forged Cylinder: 1-3/4" Mortise A02 Handed: Specify RHR or LHR</p>  	D9M10	D9M50	D9M55	D9M57
 <p><b>Essex E9M</b> Lever: Cast Escutcheon: Forged Cylinder: 1-3/4" Mortise A02</p>  	E9M10	E9M50	E9M55	E9M57
 <p><b>Lustra L9M</b> Lever: Cast Escutcheon: Forged Cylinder: 1-3/4" Mortise A02</p>  	L9M10	L9M50	L9M55	L9M57
 <p><b>Newport N9M</b> Lever: Cast Escutcheon: Forged Cylinder: 1-3/4" Mortise A02</p>  	N9M10	N9M50	N9M55	N9M57

# Heavy-Duty Mortise Trims & Functions

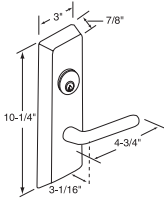
## ED5000 Series

**Features:**

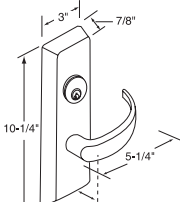
- Beveled edges
- Rigid lever when locked
- Flush cylinder
- Through-bolted to exit device
- 5-year limited warranty

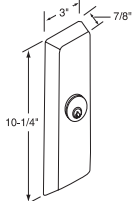







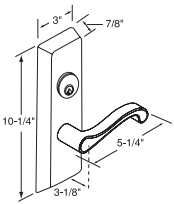

Trim Design	Trim/Function			
	Passage ANSI No. 14	Dummy ANSI No. 02	Classroom ANSI No. 08	Nightlatch ANSI No. 03
 <p><b>Regis R9M</b> </p> <p>Lever: Cast Escutcheon: Forged Cylinder: 1-3/4" Mortise A02 </p> 	R9M10	R9M50	R9M55	R9M57
 <p><b>Princeton PR9M</b> </p> <p>Lever: Cast Escutcheon: Forged Cylinder: 1-3/4" Mortise A02 </p> 	PR9M10	PR9M50	PR9M55	PR9M57
 <p><b>Escutcheon F9</b></p> <p>Escutcheon: Forged Cylinder: 1-3/4" Mortise A02 </p> 	N/A	F950	N/A	F9M57

# Heavy-Duty Mortise Trims & Functions

## ED5000 Series

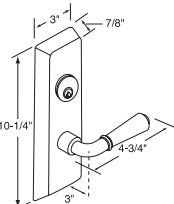
### Features:

- Beveled edges
- Rigid lever when locked
- Flush cylinder
- Through-bolted to exit device
- 5-year limited warranty

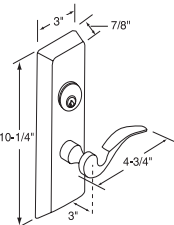
Trim Design		Trim/Function				
		Passage ANSI No. 14	Dummy ANSI No. 02	Classroom ANSI No. 08	Nightlatch ANSI No. 03	
	<b>Frascati FR9M</b>  Lever: Cast Escutcheon: Forged Cylinder: 1-3/4" Mortise A02  Handed: Specify RHR or LHR		FR9M10	FR9M50	FR9M55	FR9M57
	<b>Merlot M9M</b>  Lever: Cast Escutcheon: Forged Cylinder: 1-3/4" Mortise A02 		M9M10	M9M50	M9M55	M9M57
	<b>Zinfandel Z9M</b>  Lever: Cast Escutcheon: Forged Cylinder: 1-3/4" Mortise A02  Handed: Specify RHR or LHR		Z9M10	Z9M50	Z9M55	Z9M57

# Mortise Utility Trims & Functions













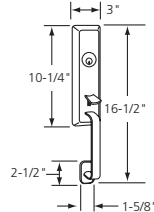

## ED5000 Series

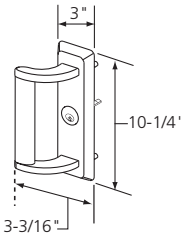
### Mortise

#### Features:

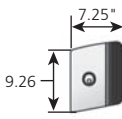
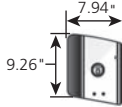
- Vandal-resistant design
- Beveled edges

- Through-bolted to exit device
- Flush cylinder with 6-pin cylinder applications
- 5-year limited warranty







Pull Trim Design	Trim/Function				
	Passage ANSI No. 14/15	Dummy ANSI No. 02	Classroom ANSI No. 05/08	Nightlatch ANSI No. 03	
 <p><b>TH9M00 Trim</b> Pull: Extruded Escutcheon: Forged Cylinder: 1-3/4" Mortise A02  Projection: 2-11/16"</p>		TH9M10ET	TH950ET	TH9M55ET	TH9M57ET
 <p><b>Offset Pull P9M</b>  Pull: Extruded Escutcheon: Forged  Cylinder: 1-3/4" Mortise A02 Handed: Specify RHR or LHR</p>		N/A	P950ET	N/A	P9M57ET (03)
 <p><b>VT9M Trim</b>  Plate: Formed Stainless Steel Cylinder: Mortise  Handed: Specify RHR or LHR Available in 630 finish only.</p>		N/A	VT950ET	N/A	VT9M57ET
		N/A	VTL950ET <sup>3</sup>	N/A	VTL9M57ET <sup>3</sup>
 <p><b>Key Only K1M</b>  Note: Available with cylinder option only. Ex: K1M57 x 6P.</p>		N/A	N/A	N/A	K1M57ET

3. VTL has a lip that covers door gap and protects the latch.

# Mortise Utility Trims & Functions

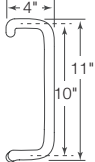
## ED5000 Series

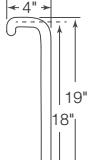
### Offset Pull Trim: P12, P13, P14\*

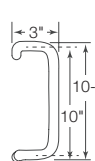
	<p><b>Offset Pull P12</b> Clearance: 2-1/2" </p>		<p>Specify Part Number, 716F50M x Finish<sup>1</sup></p>
	<p><b>Offset Pull P13</b> Clearance: 2-1/2" </p>		<p>Specify Part Number, 716F51M x Finish<sup>1</sup></p>
	<p><b>Offset Pull P14</b> Clearance: 2-1/2" </p>		<p>Specify Part Number, 716F52M x Finish<sup>1</sup></p>

1. Available in 605, 606, 612, 613, 626, 629 and 630 finishes.

\* Available on 1 3/4" thick doors only.

# Mortise Decorative Trims & Functions



















































## ED5000 Series

### Mortise Features:

- Beveled edges
- Rigid lever when locked
- Through-bolted to exit device
- Flush cylinder
- 5-year limited warranty



Lever: Cast  
Escutcheon: Forged  
Cylinder: 1-1/2"  
Mortise A02 

Lever Designs (Choose from list below)	Functions					How to Order Example: Trim x Function # 102910			
	Passage ANSI No. 14 Function #910	Dummy ANSI No. 02 Function #950	Classroom ANSI No. 08 Function #955	Nightlatch ANSI No. 03 Function #957	Storeroom ANSI No. 09 Function #959				
<b>Muséo®</b>									
<b>Georgia</b>									
	101 <sup>4</sup>	102	103	104 <sup>4</sup>	124 <sup>2</sup>	125 <sup>2</sup>			
<b>Salvador</b>									
	106	107	108	109	110	123 <sup>2</sup>	128 <sup>2</sup>		
<b>Marc</b>									
	111 <sup>4</sup>	112 <sup>4</sup>	113 <sup>4</sup>	114 <sup>4</sup>	115 <sup>4</sup>	116 <sup>4</sup>	130 <sup>2,4</sup>	131 <sup>2,4</sup>	132 <sup>2,4</sup>
<b>Jackson</b>									
	105 <sup>4</sup>	117 <sup>4</sup>	119 <sup>4</sup>	121 <sup>4</sup>	122 <sup>4</sup>	126 <sup>2,4</sup>	127 <sup>2,4</sup>		
<b>Piet*</b>									
	21G	21L	21M	21S	23M	25M	27M		
<b>Joseph<sup>3</sup></b>									
	133	134 <sup>2</sup>	135	136 <sup>2</sup>	137	138 <sup>2</sup>			
<b>Georges</b>									
	139	140	141	142	143				
<b>Laszlo</b>									
	147	148	149	150					

\*See pages 60 for how to order the Muséo® Piet Lever Collection.  
 1. Classroom function trims can be converted to Storeroom function by a simple field adjustment.  
 2. Complies with codes requiring lever to return to within 1/2" (13mm) of door face.  
 3. 135-138 contain white or black polycarbonate insert  
 4. Not available in 32D or 32 finish



# Electrified Exit Devices

## ED5000 Series

### Electrified Exit Devices

The Corbin Russwin ED5000 series electrified exit devices offer a complete range of options that may be integrated into the monitoring security and alarm systems of most buildings. The continuum of appearance is maintained, as well as the security and function of the ED5000 series mechanical exit device.



List No.	Exit Device Description	Available options										
		MELR	M61	M91	M92	M93	M97	SAF	SEC	D	9903	9905
ED5200 (A)	Rim Exit Device	x	x	x	x	x	x			x	x	x
ED5200S (A)	Rim SecureBolt® Device	x	x	x	x	x	x			x	x	x
ED5400 (A)	Surface Vertical Rod	x	x	x	x	x	x			x	x	x
ED5470 (B)	Surface Vertical Rod	x	x	x	x	x	x			x	x	x
ED5600 (A)	Mortise Exit Device	x	x	x	x		x	x	x	x		
ED5800 (A)	Concealed Vertical Rod	x	x	x	x	x	x			x	x	x
ED5860 (B)	Concealed Vertical Rod	x	x	x	x	x	x			x	x	x

### Electrified Hardware Option Descriptions

MELR	Motorized Electric Latch Retraction
M61	Alarm Option
M91	Bolt Monitor
M92	Touchbar Monitor
M93	Trim Monitor
M97	Electric Dogging
SAF	Fail Safe Operation
SEC	Fail Secure Operation
D*	Delayed Egress <sup>2</sup>
9903	Fail Safe Electrified Trim
9905	Fail Secure Electrified Trim

\* Add as suffix to exit device.  
Example: ED5200D x 630 x RHR

Note 1: The following options cannot be ordered together on the same device:

- (MELR or M97) & D
- MELR x M97
- M52 x M97
- M97 x M107
- (M61 or M92) & D
- M61 x M92
- M61 x MELR
- M61x M52
- M52 & D
- ED5600 x M91 & M93
- (ED5600 SAF or SEC) x (M91 or M93)
- Surface vertical rod exit devices with M61 x M91, M92 or M93.
- (MELR or M97) x W024

Note 2: When ordering a surface vertical rod exit device with the D option, rod and latch guards (provided by other) must be used.

Note 3: M88 (NFPA30) M89 (BOCA-15) and M90 (BOCA-30) are available only as options for suffix "D" Delayed Egress Exit Devices.

# Electrified Exit Devices

## ED5000 Series

### Electric Latch Retraction - MELR

The Motorized Electric Latch Retraction (MELR) exit device provides remote-controlled latch retraction that delivers quiet, smooth operation for convenient, hassle-free egress. Easily installed in new applications and available as retrofit rail kit assemblies for field updates, the MELR features maintenance-free design with few moving parts using 86% less power consumption during retraction than solenoid devices. Plus, MELR is powered by a standard power supply, simplifying installation and increasing system design flexibility.

#### Application

SecureBolt® Exit Devices  
Rim Exit Devices  
Surface Vertical Rod Exit Devices  
Concealed Vertical Rod Exit Devices  
Mortise Exit Devices

#### Listings

UL listed for both Panic and Fire Exit Hardware. Windstorm rated with M107 option.

#### Bar Length/Door Width

Easily field cut to size.  
Standard: 36" (914mm)\* bar fits 34" - 36" (762mm-914mm) door.

\*Bar fits 34" -36" when equipped with MELR Option.

Optional: 24" (610mm) bar fits 24" (610mm) door; specify W024.

Optional: 48" (1219mm)\* bar fits 36" -48" (914mm-1219mm) door; specify W048.

\*bar fits 39" -48" when equipped with MELR Option

#### Electrical Specifications

24VDC (BPS-24-1) regulated/filtered power supply. Requires 1A per device

#### Motor Driven Latch Retraction

.65A amp max during retraction  
.2 amp holding-continuous duty

Device bolts remain retracted for as long as the device is energized.

Removal of power returns the device to the life safety, self-latching mechanical mode.

Interfaces with central or local fire alarm system, automatic door operators, access control systems, security alarm systems, and blow open

door systems.

Amount of rail retraction is automatically controlled by controller PC board; system actively monitors position and speed and adjusts itself.

#### Timer

Digital retraction timer (0-20 seconds) or set to power mode for access control systems.

#### Hinges

Standard electric hinge. No special power transfer required.

**Note:** This feature is not available with Electric Dogging (M97) or delayed egress (D) on the same device.

The MELR feature is not available when combined with the Exit Device Alarm (M61), Electric Dogging (M97), or Delayed Egress (D) options.

#### Warranty

5 years

#### How to Order

Specify Quick Code MELR.



# MELR Retrofit Device Assembly

## ED5000 Series

Existing solenoid and mechanical devices can be retrofit to motorized electric latch retraction (MELR) by purchasing retrofit kits via the following associated part numbers, if the device was manufactured after April 2015.

List Number	Product Description	Available Options			
		None	M93	M107	M107 & M93
CRMELR-36	ED5000 36" MELR DEVICE ASSY	X	X	X	X
CRMELR-48	ED5000 48" MELR DEVICE ASSY	X	X	X	X

Note:

- For devices that use the M91 option, simply connect the wire from the existing switch to the new rail.
- For devices that use the M92 option, the existing switch needs to be moved and wired to the new rail.
- For a list of replacement parts for existing motorized electric latch retraction devices, contact Technical Product Support at 888-607-5703.
- 782 Controller CANNOT be used with MELR. Recommend BPS-24-XX

### Latchhead Requirements

Existing solenoid and mechanical devices manufactured prior to April 2015 require the device assembly retrofit kit (see above) and a new latchhead. Refer to the ED5000 Series Parts & Service Manual for latchhead replacement part numbers.

#### Latchhead Pins (Since April 2015 (17/15))

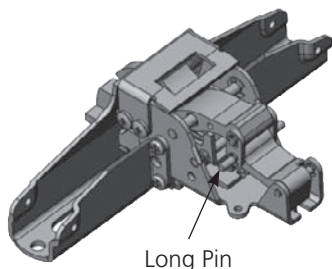

#### Latchhead Pins (Prior to April 2015 (17/15))

New latchheads must be ordered when upgrading to MELR if the Date Code Label is before 17/15. See parts manual for replacement part numbers.

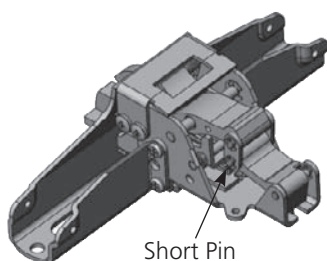

#### Date Code Label Example

80-7710-0010-048  
AAO  
17/15

17/15 refers to 17th week of 2015.

Note: Label with date code is located on front face of latch head.

# Electrified Exit Devices

## ED5000 Series

### Delayed Egress Exit Device - D

The delayed egress option provides additional security and safety in a strong line of exit hardware. The delayed egress exit device is an electromechanical device used to secure interior or exterior openings.

#### Operation

The exit door is normally closed and latched. The Delayed Egress Exit Device "D" secures the door in the locked mode with the solid Red LED indicating locked mode status. Depressing the pushpad for less than 3 seconds will sound the nuisance beep without initiating the alarm. Depressing the pushpad for 3 seconds or longer will initiate an irreversible local audible beeping tone and a visual amber indicator until the device releases. The person depressing the exit bar is denied egress for 15 or 30 seconds and security personnel are alerted. After the delay time of 15 or 30 seconds the device releases, the LED changes to Green, and the alarm changes to a steady tone which continues to alarm until manually reset by key. The remote monitoring contact outputs can be used to alert security personnel.

**Note:** The 15-second time delay is standard. 30-second time delay is optional (may be accepted by local jurisdiction).

#### Applications

- For use on hollow metal, wood or composite interior or exterior doors.
- Available for rim, SecureBolt®, surface vertical rod, concealed vertical rod and mortise panic and fire-rated exit devices. For surface vertical rod exit devices, rod and latch guards must be used. Consult factory for more information.
- Complies with NFPA 101 "Code For Safety To Life From Buildings And Structures" by National Fire Protection Association.
- BOCA options available to comply with National Building Code requirements. BOCA option is not suitable for installations in accordance with NFPA 101.



- 1-3/4" (45mm) door thickness standard; 2" (51mm) and 2-1/4" (57mm) optional; specify D200 or D214 when ordering.
- Standard 36" device fits 36" doors only. Device cannot be cut less than 36".
- Option W048 fits doors 42" – 48". Devices cannot be cut less than 42".

#### Listing

- UL/cUL Listed
  - Fire Exit Hardware (GXHX/GXHX7)
  - Controlled Exit Panic Device (FUKD/FUKD7)
  - Special Locking Arrangements (FWAX/FWAX7)
- BHMA (ANSI A156.3 and ANSI A156.24) Directory of Certified Exit Devices

#### Specifications

Input Voltage: 24VDC (+/- 10%) Regulated and filtered.

#### Power Consumption

- Standard Device: 500 mA
- Device with Electric Trim Control: 1.5 Amp
- Mortise Device with "Safe" or "Secure" option: 1.5 Amp

#### Standard Features

##### Key Switch Operation:

- Normal: The system is armed by applying power to the device (solid Red LED). Depressing the pushpad for more than the nuisance delay time starts the exit delay cycle.
- Bypass: Turning the key switch clockwise to the bypass position allows immediate egress without alarming. The bar functions as a standard exit device. (Red LED flashes slow.)
- Reset/Delay: Used to reset device after the factory set 15 or optional 30 second delay cycle has timed out. If the device is armed, turning the key switch counterclockwise to

the reset mode will release the device without alarm for egress and will rearm after 5, 10 (default), 20 or 40 seconds. (Red LED flashes quickly.)

- Alarm Strength: 85 Db @ 10'.

#### Local Visual Status Indicator:

- RED: The exit device is secure and the delayed egress circuitry is energized.
- AMBER: The egress cycle has started, indicated by an irreversible local audible beeping tone.
- GREEN: Exit device is in alarm and has released.

#### Nuisance Delay Time:

With 3 second (default) setting depressing the push bar for less than 3 seconds sounds an audible beep without activating the irreversible alarm sequence. (Nuisance Delay Times are dip switch selectable to immediate, 1, 2, or 3 (default) seconds on the control board.

#### Internal Alarm Siren:

When the exit device is armed, depressing the push pad initiates the internal 85db alarm siren.

#### Door Position Switch (DPS) Control

**Board input:** Allows external DPS wiring to control board for higher security. Alarm sounds when the DPS contacts open when the door is forced open.

#### Remote Control Inputs:

- Remote Reset: Accepts a momentary contact (keyswitch, pushbutton, etc.) to reset the unit during alarm or allows momentary egress selectable 5, 10 (default), 20 or 40 seconds when the unit is armed.
- Remote Bypass: Accepts a momentary contact to put the unit in a maintained bypass operation. The exit device functions as a standard device.

# Electrified Exit Devices

## ED5000 Series

### Alarm Outputs:

Contacts change only during alarm status. Alarm Relay Output contacts change state when device delay cycle has started (Alarm). Contacts are selectable for Normally Open (N.O.) or Normally Closed (N.C.) using the 2-pin jumper on the control board. N.O. is default setting. One set of contacts changes when device delay cycle has started (Alarm). Another set of contacts change state when device has released (Secure). Secure Relay Output has two sets of contacts (N.O. and N.C.). The Alarm Relay and Secure Relay contacts are SPDT type, rated 1A @24VDC.

### Rearm After Closing (RAC)

Works in conjunction with an external DPS wired to the Control Board. Field selectable settings:

Setting 1: If the door is open beyond the momentary egress or remote reset time the device will Alarm.

Setting 2: If the door is open beyond the momentary egress or remote reset time the device will remain in egress mode indefinitely until the door closes (will not Alarm).

### Door Sign:

Door sign per code included.

### How to Order

Specify "D" suffix after device.  
Example: ED5200SD

### Options

#### Bolt Position Monitor M91:

SPDT (Single Pole Double Throw) switch that monitors the position of the latchbolt or vertical rods. To order, specify M91.

#### Outside Trim Monitor M93:

Used when outside trim is desired to be used with an external door position switch (by others) input. This switch will allow Bypass (disarms device) when the trim is used for ingress. The device requires setting after entry by means of the keyswitch on the device or a remote switch. To order, specify M93.

**Note:** If an external DPS is not used, standard trim will allow entry without affecting the device in an armed mode. The device will only be affected when the

touchbar is depressed.

#### Mortise Electric Trim Control SAF/SEC:

The mortise delayed egress exit device can be ordered with Fail Safe or Fail Secure outside trim operation. In a fire condition the Fail Safe trim will release for entry. When access control is used the Fail Secure trim allows entry by means of a remote card reader, keyswitch, pushbutton, etc. To order, specify SAF or SEC.

**Note:** The trim will open the door without affecting the device in an armed mode if a door position switch (by others) is not used.

#### 30-Second Delay M88:

Device released after 30 seconds. The device will provide visual and audible indication that the delayed egress cycle has been activated. After the device has been released, the siren changes to a steady tone which continues until reset by keyswitch or remote inputs on the device. Required signage must indicate 30 seconds for release. To order, specify M88.

**Note:** 30 seconds may be accepted by local jurisdiction.

#### BOCA 15-Second Delay M89:

#### BOCA 30-Second Delay M90:

Upon pressing the touchpad for 3 seconds or more, the device will sound an audible beeping tone and release for egress after a total of 15 or 30 seconds, sounding the alarm. When the door is re-secured, the device will automatically rearm after 30 seconds. A door position switch (by others) is required for this option. Required signage must indicate 15 or 30 seconds for release. To order, specify M89 for BOCA 15 seconds or M90 for BOCA 30 seconds.

**Note:** BOCA option is not suitable for installations in accordance with NFPA 101.

### Required Accessories

#### Power Supply:

A regulated and filtered power supply with a Fire Alarm interface is required. 1 Amp minimum @ 24VDC per device. Special options will require more amperage. Consult factory.

To order, specify:

- BPS-24-1 – 1 Amp @ 24VDC power supply (controls 1 "D" device)
- BPS-24-2 – 1.5 Amp @ 24VDC power supply (controls 2 "D"s or 1 "D" with SAF or SEC options)

#### Power Transfer:

Allows the power to make the transition from frame to door without pinching or removal of insulation. Optional power transfer: EPTL – concealed transfer for up to and over 120° swing doors. To order specify Part No. 704F28. Consult catalog for additional recommended power supplies and accessories.

#### Trims

Utilizes heavy-duty and utility trims. See Trims and Functions, pages 28-35.

#### Cylinders

Utilizes a 1-1/8" mortise cylinder; A02 cam. Cylinder not included unless specified. See Quick Codes, page 54.

#### Warranty

Exit devices and heavy-duty trim carry a five-year limited warranty. Electronic components carry a two-year limited warranty.



Refer to McKinney Power Transfer Device catalog for ElectroLynx options

ElectroLynx® Power Transfer Device Options		
Hinge	External DPS	Options
QC8	Not required	None
QC12	Required	M91, or M93, or Fail Safe/Secure Options



# Electrified Exit Devices

## ED5000 Series

### M61 Exit Alarm



#### Activation

Alarm is armed by turning key clockwise. Low audible chirp indicates alarm has been activated. Alarm will sound when the exit device pushpad is depressed. Factory preset for standard alarm mode which automatically resets after 5 minutes.

#### Continuous Alarm Mode

Alarm sounds continuously when the exit device pushpad is depressed. Alarm must be manually reset by keyswitch. (This feature is selected by a switch on the circuit board.)

#### Low Battery Warning

Audible chirp. Every 30 seconds.

#### Warning Decal

"EMERGENCY EXIT-ALARM WILL SOUND" provided.

#### Nuisance Alarm

Units are factory preset for instant alarm. Selectable feature for alarm to sound when exit device touchbar is depressed for more than 2 seconds. (This feature is selected by a switch on the circuit board.)

#### Kit

Available in kit form for field retrofit except surface vertical rods. Order ED50AK.

#### Arming Delay/Authorized Egress

A 10-second delay (after arming) permits egress (by turning key clockwise).

#### Alarm Shunt

Ingress shunt alarm input for devices with signal & outside trim monitors (M91 & M93).

#### Power Requirements

One 9-volt battery (included).

#### Alarm Strength

90db @ 10 feet.

#### Arm/Disarm

Requires one 1-1/8" A02 cam mortise cylinder. Clockwise turn arms the alarm, counterclockwise turn disarms or silences the alarm. Low audible chirp indicates alarm has been activated.

#### Device Status

A Red LED indicator will illuminate every 30 seconds when the alarm is armed.

#### Tamper Resistant

Built-in safety monitor sounds alarm when tampering occurs.

#### Cylinders

Mortise 1-1/8" A02 Cam. Cylinder not included unless specified. See Quick Codes, page 54.

#### Door Width

Available for 36"-48" devices only. Not available with devices less than 36". 48" device can be cut to fit 42"-48" door.

#### Quick Code

M61

#### Alarm Kit

ED50AK

ED50AK x W048 (48" devices) optional

#### Hard Wired Option

A hard wired option is available by using a 9VDC output power supply and a remote power harness. Specify 784 to order the 9VDC output power supply. See page 45 for 784 power supply information. Specify 709F989 to order the remote power harness for a 36" device and specify 709F999 to order the remote power harness for a 48" device.

#### Exceptions

The ED50AK for the ED5000 series exit devices cannot be retrofitted in the field to the ED5400/5470 series surface vertical rod exit devices.

The alarm option is available for the surface vertical rod devices by factory order only. To order, add the quick code suffix M61 to the device number; for example, ED5470 x M61.

Please note, in accordance with Corbin Russwin's standard limited warranty, any attempt to retrofit the ED50AK to a surface vertical rod exit device will void the warranties for these products.

Surface vertical rod exit devices with alarm kit cannot be ordered with M91, M92 or M93.

#### How to Order

##### Ordering example for Exit Device

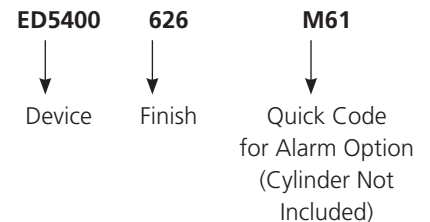

##### Ordering Example for Alarm Kit Only

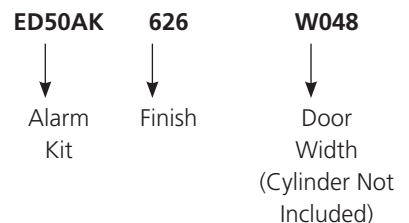

NOTE: Dogging not available with M61 option and ED50AK alarm kit.

# Electrified Exit Devices

## ED5000 Series

### Electric Dogging - M97

This electronic feature will provide continuous dogging when power is applied and the push bar is depressed manually. Interruption or removal of the power will release the pushbar and return the exit device back to normal operation.

#### **Application**

SecureBolt® Exit Devices  
Rim Exit Devices  
Surface Vertical Rod Exit Devices  
Concealed Vertical Rod Exit Devices  
Mortise Exit Devices

#### **Listings**

UL listed for both Panic and Fire Exit Hardware.

#### **Electrical Specifications**

.35 Amps @ 24VDC continuous duty  
(2) 36 volt holding magnets holding force (86 lbf. total)

**Note:** This feature is not available with Motorized Electric Latch Retraction (MELR) or delayed egress (D) on the same device.

#### **How to Order**

Specify Quick Code M97.

### Mortise Device Trim Control

#### **Safe or Secure**

Mortise device trim control provides a remote means of locking and unlocking the outside lever trim. This feature is provided by continuous duty solenoids in the device mortise lock.

#### **Application**

Mortise exit devices with lever trim.

#### **Listings**

UL listed for both Panic and Fire Exit Hardware.

#### **Electrical Specifications**

24VDC 330 milliamperes

Fail Safe units maintain the door locked as long as the device is energized.

Fail Secure units maintain the door unlocked as long as the device is energized.

Regulated 24VDC power supply required.

**Note:** SAF & SEC options are only available with ED5600L and ED5600(A)L version lock body functions and may not be combined with either the M91 or M93 monitoring options.

#### **How to Order**

Specify Quick Code "SAF" for Safe or "SEC" for Secure.



# Electrified Exit Devices

## ED5000 Series

### Electrically Controlled Heavy-Duty Trim

Electrically controlled trim provides electric locking and unlocking of the 900 Series heavy-duty lever trim. It easily retrofits into existing applications and is ideal for door control.

#### Advantages

- Available in Fail Safe or Fail Secure operation
- Features EcoFlex®
- Operates from 12-24 VDC
- Internal rectifier accepts AC or DC voltage
- Free Wheeling lever when locked
- Key override (specify cylinder)
- Plug connector with 4' wire lead (Exit device can be used as the wire raceway)

#### Applications

- ED5200(A) Rim
- ED5200S(A) SecureBolt®
- ED5400(A) Surface Vertical Rod
- ED5470(B) Surface Vertical Rod
- ED5800(A) CVR
- ED5860(B) CVR

#### Trim

Utilizes all 900 series trim lever designs including the Muséo® and Vineyard™ Collections

#### Electrical Specifications

- Actuator Draw = 400mA inrush / 15mA continuous @12VDC / 24VDC
- Security Monitor Switch (M98): 4 AMP @ 250VAC

#### Door Thickness

1-3/4" (44mm) standard.  
Optional: 2" (51mm); specify D200.  
Optional: 2-1/4" (57mm); specify D214.

#### Options

- M98 – Security Monitor. A SPDT switch that monitors the position of the motor actuator (lock and unlock status).
- M99 – Trim gasket for exterior applications.

#### Cylinder

Cylinder not included unless specified. See Quick Codes, page 54.

#### How to Order

N9903 626 RHR M98, 6P



Electrically Controlled Heavy-Duty Trim

## Functions

### Fail Safe

The x9903 trim is locked when power is on and unlocked when power is off.

	Function Description
x9903 (Fail Safe)	• Lever is locked when power is on (Free Wheeling)
	• Power off allows entry from trim
	• Inside device is always active for egress
	• Mechanical key override (09 Function – Key allows lever to retract latch bolt. Key can only be removed in locked position.)

### Fail Secure

The x9905 trim is locked when power is off and unlocked when power is on.

	Function Description
x9905 (Fail Secure)	• Lever is locked when power is off (Free Wheeling)
	• Power on allows lever activation for entry
	• Inside device is always active for egress
	• Mechanical key override (09 Function – Key allows lever to retract latch bolt. Key can only be removed in locked position.)

x = Lever trim design - Standard, Vineyard™ and Muséo®

# Electrified Exit Devices

## ED5000 Series

### EPTL

Concealed power transfer for over 120° swing doors. Installs in door and frame edges. Supports wires up to .25" (6mm) thick, and works with doors hung with butt hinges, continuous hinges and pivots. To order, specify Part No. 704F288.



EPTL

## Monitors - M91, M92, M93

### Operation

Monitors are used to indicate the authorized and unauthorized use of an opening or to signal and control other opening hardware, such as magnetic locks. Each monitoring device is equipped with one internal single-pole double-throw (SPDT) switch per monitor.

#### Bolt Position Monitoring - M91

Provides indication of the position of the latch bolt. Used with security systems to monitor the latch bolt; also used to activate automatic door operators upon latch retraction.

#### Application

See chart on page 36.

#### Listings

UL listed for both Panic and Fire Exit Hardware.

#### Electrical Specifications

2 Amps @ 28VDC  
SPDT contacts

#### Ordering

Specify Quick Code M91.

#### Touchbar Monitoring - M92 Request to Exit - REX

Provides indication of the pushpad being depressed. Used as a request to exit to shunt alarm systems, release electromagnetic locks or monitor egress.

#### Application

See chart on page 36.

#### Listings

UL listed for both Panic and Fire Exit Hardware.

#### Electrical Specifications

2 Amps @ 28 VDC  
SPDT contacts

#### Ordering

Specify Quick Code M92.

#### Outside Monitoring or Signaling - M93

Provides indication of the device being operated from the outside. Used as a request to enter signal switch to shunt alarms; also used to monitor entry.

#### Application

See chart on page 36.

#### Listings

UL listed for both Panic and Fire Exit Hardware.

#### Electrical Specifications

2 Amps @ 28VDC  
SPDT contacts

#### Ordering

Specify Quick Code M93.

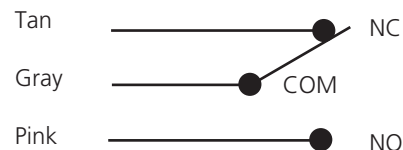
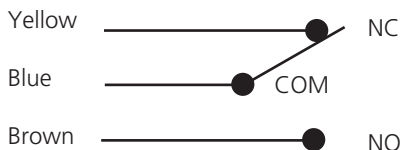
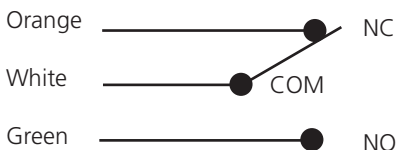

# Electrified Options & Accessories

## ED5000 Series

### BPS Power Supply

#### Operation

Power supplies are designed to provide reliable filtered and regulated power for long life to a variety of electrified hardware components. Recommended for the SAF, SEC, M97, MELR, delayed egress exit devices and electric trim.

#### Features

- Individual output circuit breakers
- Regulated and filtered fuse protected outputs
- LEDs monitor zone status (voltage or no voltage)
- Slide switches connect or disconnect load from power (Not available on 1 Amp supplies)
- Internal Back-Up battery charging circuit
- Rugged steel enclosure
- Fire alarm interface

#### Electrical Specifications

- Inputs: 120VAC
- Outputs: 12/24 VDC @ 1 Amp, 2 Amp or 4 Amp, Filtered and regulated outputs

#### Listings

- UL-cUL CLASS 2
  - Signal Appliances
  - Access Control System Units
  - Special Locking Arrangements - Component
- CE

#### Applications

- D – Delayed Egress
- M97 – Electric Dogging
- SAF – Fail Safe mortise device trim control
- SEC – Fail Secure mortise device trim control

Note: Batteries are not included with the BPS power supply.

Model	Enclosure	Input	Output
BPS-24-1	12" (304mm) x 9" (229mm) x 4" (102mm)	120VAC	1.0 Amp @ 24 VDC
BPS-24-2	14" (356mm) x 14" (356mm) x 4" (102mm)	120VAC	2.0 Amp @ 24 VDC
BPS-24-4	15" (381mm) x 18" (457mm) x 6" (152mm)	120VAC	4.0 Amp @ 24 VDC
BPS-12-1	12" (304mm) x 9" (229mm) x 4" (102mm)	120VAC	1.0 amp @ 12 VDC
BPS-12-3	14" (356mm) x 14" (356mm) x 4" (102mm)	120VAC	3.0 amp @ 12 VDC

### 784 Power Supply

#### Features

- Provides a filtered and regulated 9 VDC remote power
- Requires raceway through the door\*

#### Includes:

- Plug-In Wall Transformer with approximately 12' (3.6m) of shielded wire that provides input power to the power supply
- Includes 12' (3.6m) of shielded wire for connection between power transfer and power supply
- To order separately, specify 793F039

\*Recommended for new opening. Retrofit application may require surface mounted wire mold and transfer loop by others.



## Exit Controls and Switches

### Key Switches

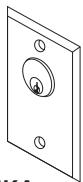

MKA

MKA - (1) SPDT Maintained  
 MK - (1) SPDT Momentary  
 MKN - (1) SPDT Momentary NS  
 MK2 - (1) DPDT Momentary  
 MKPZ x MKS - (1) SPDT Momentary with audio Double Gang x Additional Switch  
 Note: All key switches come standard with 12/24 VDC bi-color LED.

#### Specifications

- Keyswitch for operation using a standard 1-1/8" mortise cylinder (A02 cam) (cylinder not included).
- Contact Rating 5 Amps @ 12-24VDC
- SPDT 3-position.

### Push Buttons

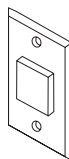

PB2

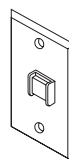

PB3

PB2 - (1) SPDT Momentary  
 PB2 - (1) DPST Remote Momentary  
 PB3 - (1) DPST Momentary  
 PB3A - (1) DPST Maintained (Alt. Action)  
 PB3EA - (1) DPST Alternate

#### Specifications

- 3 Amps @ 12-24 VDC

### Audible/Visual Annunciators

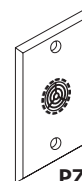

PZ1

PZ1 - Sonalert 90db @ 2ft. 12-24VDC.  
 Mounted on one gang stainless steel plate.

#### Digital Entry

DK-12 - Digital Keypad - 4 User  
 DK-26SS - Digital Keypad NS - 59 User - SS Finish  
 DK-26BK - Digital Keypad NS - 59 User - Black Finish

#### Power Transfers

TSB B-C - Door Cord

# Electrified Applications

## ED5000 Series

### Requirements for Electrical and Data Transfer

To answer the demand for “smart” electronic access control and locking solutions that require fast, easy, and cost-effective installation, ASSA ABLOY Group brands use the ElectroLynx® standardized plug-in connectors and color-coded wiring system.

With *ElectroLynx*, doorway components come pre-wired for easy hookup to the power source. Key to the system is the transfer device hinge that carries power from the frame to the locking hardware.

Features of *ElectroLynx*:

- Makes it easy to bring power to the locking hardware
- Wires have connectors that snap together, like plugging a telephone into a jack

To connect an electrified ED5000 series exit device to the electronic access control system, the following items are required:

- Electrified ED5000 series exit device
- ASSA ABLOY Door Group pre-wired door, or *ElectroLynx* retrofit cable (order from McKinney)
- Electronic transfer device (*ElectroLynx* electronic transfer hinge or Electrical Power Transfer with standard hinge, from McKinney)
- *ElectroLynx* cable from the hinge to above the ceiling (order from McKinney)

Information regarding cable selection, hinge requirements and order strings can be found in the McKinney Transfer Device Solutions catalog. Consult 800-810-WIRE (9473) with questions on application specifications and requirements.

The McKinney QC8 *ElectroLynx* Hinge is recommended for the 9903 function, the 9905 function and all options with the exception of M61 and M93. The McKinney QC12 *ElectroLynx* Hinge is recommended for the M61 and M93 options.

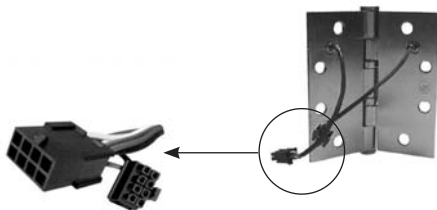

### Latch Pullback - MELR Option

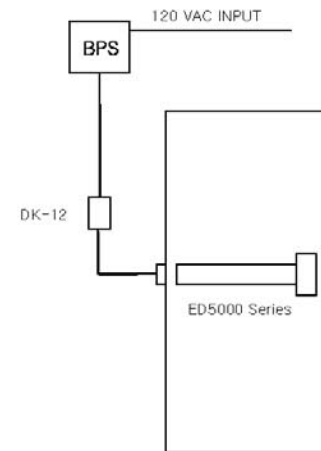

### Components

ED5000 Series x MELR Latch Retraction  
Exit Device - Corbin Russwin  
DK-12 Digital Keypad  
Power Transfer Hinge

### Operation

Operation of DK-12 Digital Keypad will allow keyless entry from the nonprotected side of opening. Free exit using the exit device from the protected side of the door.

# Electrified Applications

## ED5000 Series

### Electric Dogging & Touchbar Monitoring Switch - M97 & M92

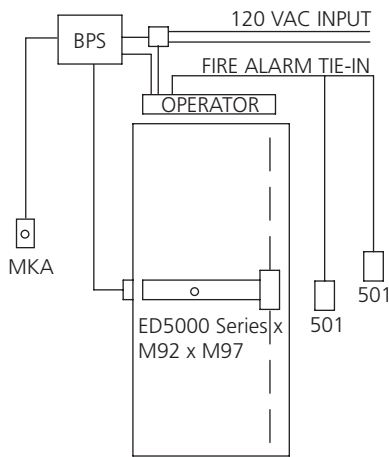

#### Components

ED5000 Series x M92 x M97 with Cyl. + Bar Monitor & Elect. Dogging - Corbin Russwin  
Automatic Door Operator - Norton  
501 Push Switches or 700 Wave to Open Switches - Norton  
Power Transfer Hinge  
BPS Power Supply - Corbin Russwin  
Key Switch - Corbin Russwin

#### Operation

Operation of Electric Dogging combined with the Door Monitor Switch will enable Push Switches for operation of the 6000. A maintained keyswitch will control the activation of the electric dogging which is powered by the Power supply. A Fire Alarm Tie-In, if required, will release the dogging and let the operator work in manual mode when activated. (NOTE: Electric Dogging is not automatic like Latch Retraction. It requires the bar to be pushed in manually the first time after applying power.)

### Device with Electric Strike

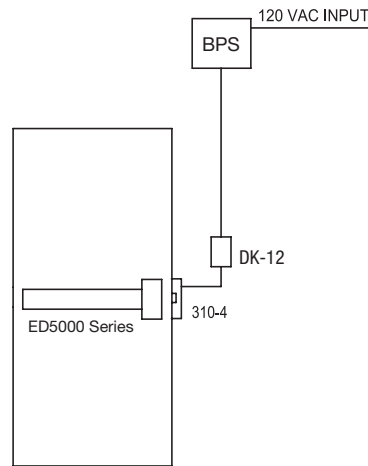

#### Components

ED5000 Series Exit Device - Corbin Russwin  
Digital Keypad  
310-4 Electric Strike  
BPS Power Supply - Corbin Russwin

#### Operation

Operation of DK-12 Digital Keypad will allow keyless entry from the non-protected side of opening. Free exit using the exit device from the protected side of the door.

### Latch Pullback - MELR Option with Norton® Automatic Door Operator

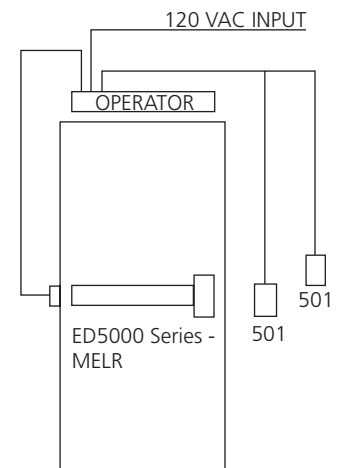

#### Components

ED5000 Series x MELR Latch Retraction Exit Device - Corbin Russwin  
Automatic Door Operator - Norton  
501 Push Switch or 700 Wave to Open Switches - Norton  
Power Transfer Hinge  
Keyswitch - Corbin Russwin

#### Operation

Activation and operation of Push Pads from either side of door will be controlled by the Maintained Keyswitch. The Push Switches will in turn activate Latch Retraction Exit Device. An internal timer on the 6000 will coordinate and prevent the door from being opened before latch retraction takes place. Standard timers on the 6000 will also provide length of time door is open and latch being retracted. Door operator also acts like standard closer when opened manually.

# Electrified Applications

## ED5000 Series

### Exit Device with Delayed Egress Option on "Exit Only" Door

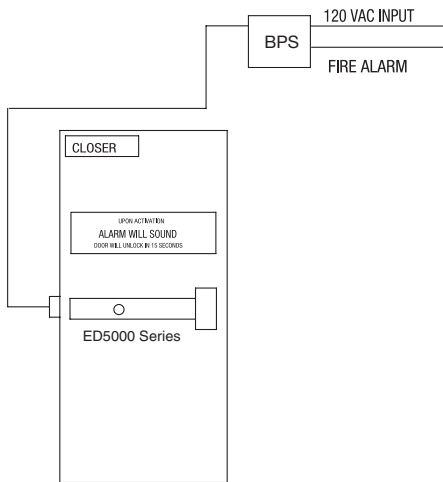

#### Components

ED5000 Series - Delayed Egress Exit Device - Corbin Russwin  
Power Transfer Hinge  
BPS Power Supply - Corbin Russwin  
Surface Door Closer - Corbin Russwin

#### Operation

Operation of the ED5000 Series D Exit Device will sound an alarm and activate either a 15- or 30-second alarm sequence inside of the exit device. After this time period, the device will release the push bar, making it active, and egress is possible. When the fire alarm is activated, power to the exit device will be interrupted, allowing free egress and mechanical latching. Authorized alarm bypass and reset is done through the built-in keyswitch located in the exit device.

### Exit Device - High-Security Application M91, M92 and M93 Monitoring Switch Options With Door Position Switch

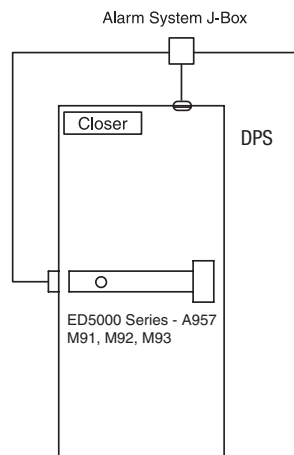

#### Components

ED5000 Series - A957 Nightlatch Trim - Corbin Russwin  
M91 Bolt Monitor Switch  
M92 Touchbar Monitor Switch  
M93 Trim Monitor Switch  
Door Position Switch  
Power Transfer Hinge  
Surface Door Closer - Corbin Russwin

#### Operation

Operation of the ED5000 Series Exit Device with the M91, M92, M93 and a door position switch can be used together or individually to sound an alarm, shunt an alarm, monitor the door's security or as a "Request to Exit" in conjunction with a magnetic lock.

### Electric Trim

### Exit Device with Electrified Trim

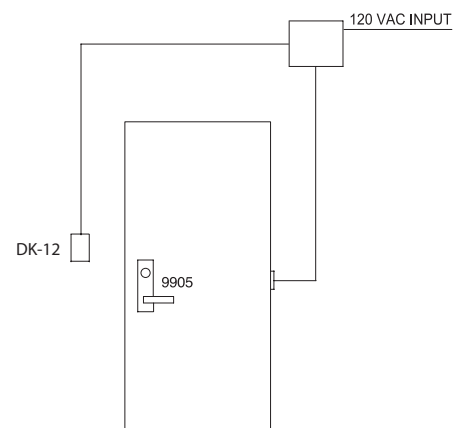

#### Components

9905 Electrified Trim - Corbin Russwin  
ED5000 Series Exit Device - Corbin Russwin  
DK-12 Digital Keypad by Corbin Russwin  
Electrified Hinge  
BPS-24-1 Power Supply - Corbin Russwin

#### Operation

Operation of the 917 Digital Keypad will allow keyless entry from the non-protected side of the opening. When a valid code is entered into the keypad, voltage will be applied to the trim, making the lever active and allowing ingress. Free exit is allowed by using the exit device from the protected side of the door.

# Mullions and Surface Bolt Kit

## ED5000 Series



### Mullions

Used to install two Rim Exit Devices in a double door opening. May be quickly and easily removed when a full double door opening is temporarily required.

### Materials and Finish

Steel mullions, 2" x 3" with malleable iron top and bottom retainers; furnished with zinc-plated fasteners for metal frames and concrete floors. May be cut, drilled and tapped in the field for Rim Exit Devices. Mullion and Mullion retainers are prime coat red paint.

### Options

#### Spacer Block

Recommended for double rabbeted frames where the stop face width is less than the mounting hole spacing and also for door frames 5-3/4" (176mm) or less. To order with a mullion, specify M95. To order separately, specify Part No 744F328.

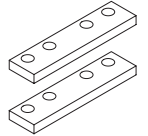

#### Angle Bracket

Recommended for any header configuration with less than 3" (76mm) of mounting surface. To order with a mullion, specify M96. To order separately, specify Part No 744F338.

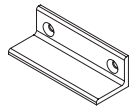

#### Mullion Stabilizer Kit

Controls the movement of the mullion. Recommended for openings over 7' high, or whenever door movement must be minimized. To order with mullion, specify M57. To order separately, specify Part No. 653F11-1 x 628 (aluminum).

#### Surface Bolt Kit

Designed for severe windload (Hurricane Code) environments where surface bolts are required (e.g., on inactive doors). To order separately, specify Part No 988CR.



## How to Order

### Removable Mullions

Door Height	Description	Specify Quick Code
Up to 7'0"	Steel Mullion - Panic Rated	CR907
Up to 8'0"	Steel Mullion - Panic Rated	CR908
Up to 10'0" (ED5200, ED5200S only)	Steel Mullion - Panic Rated	CR910
Up to 7'0"	Steel Mullion - 3 Hour Fire Rated	CR907A
Up to 8'0"	Steel Mullion - 3 Hour Fire Rated	CR908A
Up to 7'0"	Steel Mullion - 3 Hour Fire Rated, Windstorm Certified	CRFE707A <sup>1</sup>
Up to 8'0"	Steel Mullion - 3 Hour Fire Rated, Windstorm Certified	CRFE708A <sup>1</sup>

### Key Removable Mullions

Door Height	Description	Specify Quick Code
Up to 7'0"	Steel Mullion - 1-1/2 Hour Fire Rated	CR907BKM <sup>2</sup>
Up to 8'0"	Steel Mullion - 1-1/2 Hour Fire Rated	CR908BKM <sup>2</sup>
Up to 10'0" (ED5200, ED5200S only)	Steel Mullion - Panic Rated	CR910KM <sup>2</sup>
Up to 7'0"	Steel Mullion - 3 Hour Fire Rated, Windstorm Certified	CRWS707AKM <sup>2</sup>
Up to 8'0"	Steel Mullion - 3 Hour Fire Rated, Windstorm Certified	CRWS708AKM <sup>2</sup>

#### Notes:

- For use with UL listed door assemblies that comply to FEMA 361 and FEMA 320 guidelines. For the latest listings on compliant door assemblies visit our website at [corbinrusswin.com](http://corbinrusswin.com)
- Cylinder and collars not included, specify separately. See page 54.

### Parts - Key Removable Mullion

Top Retainer and Screw Packet and Bottom Retainer and Screw Packet

Mullion Series	Top Retainer and Screw Packet	Bottom Retainer and Screw Packet	Locking Mechanism Packet
CR907BKM CR908BKM CR910KM	713F948	713F988	744F258
CRWS707AKM CRWS708AKM	713F958	713F908	744F208

### Parts - Removable Mullion

Top Retainer and Screw Packet and Bottom Retainer and Screw Packet

Mullion Series	Top Retainer and Screw Packet	Bottom Retainer and Screw Packet
CR907 CR908 CR910 CR907A CR908A	713F518	713F528
CRFE707A CRFE708A	713F938	713F998

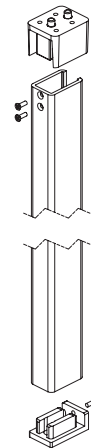



# Options & Accessories

## ED5000 Series

### Shim Kits

Designed for mounting an exit device over raised vision light molding. Each kit contains two sets of 1/8" thick shims to shim a device 1/8" (3mm) or 1/4" (6mm). Black finish. To order with exit device, specify M58. To order separately, specify Part No.

Exit Device Type	Shim Kit Part No.
ED5200 (A)	697F33-8
ED5200S(A)	
ED5600 (A)	
ED5800 (A)	
ED5860(B)	
ED5400 (A)	697F34-8
ED5470(B)	

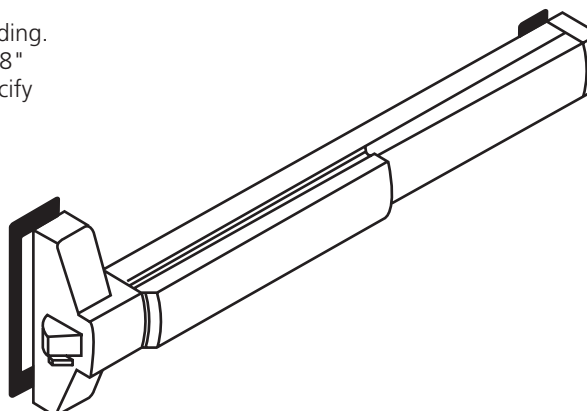

### Cylinder Dogging

To order Cylinder Dogging with exit device, specify M52. Cylinder not included unless specified. Cylinder dogging not available for fire-rated devices. See Quick Codes, page 54.

### Cylinder Dogging Kit

Designed to convert a panic device from hex key dogging to cylinder dogging. To order Cylinder Dogging Kit, specify Part Number x Finish below. Cylinder not included.

### Surface and Concealed Vertical Rod Extension Kits

Used to extend the height of standard length rods supplied with vertical rod exit devices. Available in 2", 6" and 12" sizes. To order with exit device, see Quick Codes, page 54. To order separately, specify Part No. x Finish.

Rod Extension	Rod Extension Kit Part No.
2" (50mm)	655F15 x Finish
6" (152mm)	655F16 x Finish
12" (305mm)	655F17 x Finish
24" (610mm)	684F42 x Finish

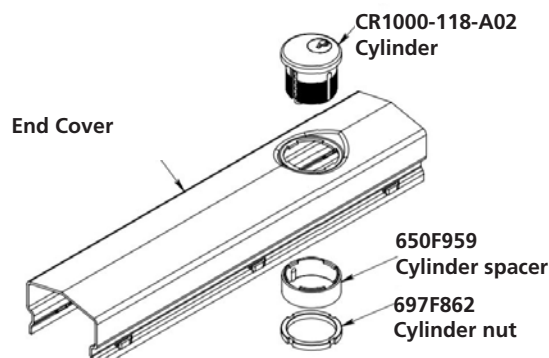

Bar Length	Cylinder Dogging Kit Part No.
Standard (W036)	650F12M x Finish
W048	650F16M x Finish

Note: Cylinder dogging not available for fire-rated devices.

### ED5000DB Inactive Bar

Non-operating dummy pushpad available for doors up to 48" wide. May be field cut for narrower doors. To order, specify ED5000DB x Finish.

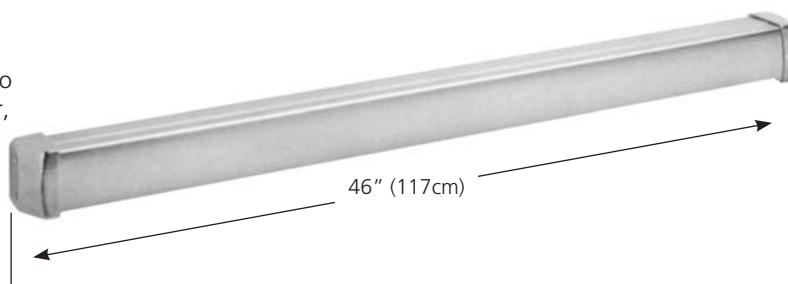

# Options & Accessories

## ED5000 Series

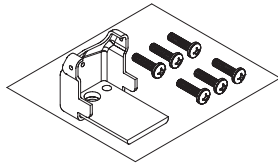

### End Cap Reinforcement\*\*

A solid steel plate, welded to the end bracket, evenly distributes impact forces over a larger surface area, eliminating point loading. To order with an exit device, specify M109. To order separately specify 705F09 x finish.

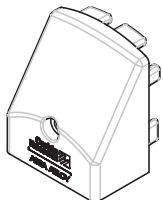

### Flush End Cap

Durable heavy-duty cast steel or stainless steel, sits flush on the exit device rail and has a low profile which eliminates catch points. To order with a device, specify M110. To order separately specify 710F00M x finish.

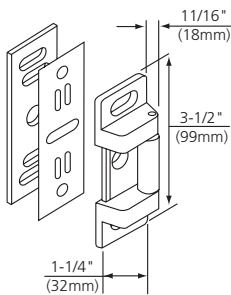

### SecureBolt® and Fire-Rated Rim Strike and Rim Strike

ED5200S, ED5200SA and ED5200(A) devices. Supplied with locking plate and two 1/16" (1.6mm) shims. For doors with 1/2" (13mm) or 5/8" (16mm) stop. Adjustable to compensate for shrinkage and swelling of door. 3-1/2" x 1-1/4" (89mm x 32mm). Black finish only. To order separately specify 650F30-8 ED5200(A) or 730F77-8 ED5200S(A).

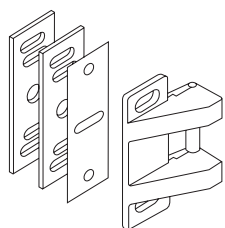

### Rim x Vertical Rod Strike

Required for ED5200 and ED5200S devices when used on pair of doors with vertical rod devices. Black finish only. To order with device, specify S02. To order separately, specify 655F71-8.

## Surface and Concealed Vertical Rod Strikes

(Screws Included)

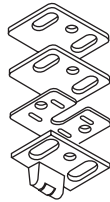

### Top Strike

Standard on ED5400(A) and ED5800(A) devices. Supplied with two 1/16" (1.6mm) shims and one 1/16" (1.6mm) locking plate. Adjustable to compensate for shrinkage and swelling of door. 1-9/16" x 15/16" (40mm x 24mm). Black finish only. To order separately, specify 650F54-8.



### Bottom Strike

Standard on ED5400(A) and ED5800(A) devices. 1-1/16" (27mm) diameter x 1/16" (1.6mm) lip x 11/16" (17mm) high. Black finish only.

Both top and bottom strikes are included in the vertical rod parts packet. To order parts packet, specify 650F57-8.

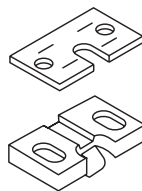

### Top Strike

Standard for ED5470 and ED5470B devices. Supplied with one 1/16" (27mm) shim. Adjustable to compensate for shrinkage and swelling of door. 2" x 1" (51mm x 25mm). Black finish only. Top strike is included in SVR parts packet. To order parts packet, specify 654F158 (M55) or 697F978. To order strike separately, specify 681F70-8.

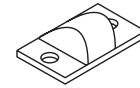

### Top Strike

Standard for ED5860 and ED5860B devices. Recessed strike. 2" x 1-5/8" (51mm x 41mm). Black finish only. Top strike is included in CVR parts packet. To order parts packet, specify 698F058 or 698F048 (M55). To order separately, specify 681F77-8.

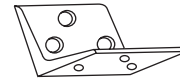

### Flush Transom Top Strike Bracket

Optional for use with ED5400 and ED5400A devices. Used to mount top strike on openings with flush transom. 2-1/2" x 1-5/8" (64mm x 41mm). Black finish only. To order with exit device, specify M67. To order separately, specify 650F87-8.

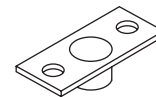

### Bottom Strike for 1/2" Thresholds

Recommended for use with vertical rod devices. Required in fire-rated openings with 1/2" (13mm) threshold or for flush mount. 2-5/8" x 1-1/16" (67mm x 27mm). Black finish only. To order with exit device, specify S09. To order separately, specify 650F88-8.

**\*\*Note:** Six 1/4 x 20 screws come standard with either M109 option or 705F09 kit. Only two screws required to fasten end cap assembly to door for retrofit. Other four screws are used with SecureBolt® Latch Head if ordered as an M109 option with complete device. When the kit is ordered a new end cap is also supplied.

# Options & Accessories

## ED5000 Series

### Mortise Strikes

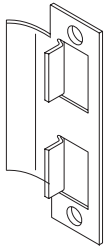

#### Mortise Strike

Standard on ED5600 and ED5600A. Non-handed, ANSI curved lip, 4-7/8" x 1-1/4" x 1-1/4" (124mm x 32mm x 32mm) lip to center. Black finish. To order separately, specify 650L657020.

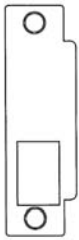

#### Mortise Strike for Pairs of Doors with Astragal

Optional for use with ED5600 and ED5600A devices where an astragal is to be installed. Non-handed, ANSI straight lip, 4-7/8" x 1-1/4" x 7/8" (124mm x 32mm x 22mm) lip to center. Black finish. To order with exit device, specify SS078. To order separately, specify 653L157014.

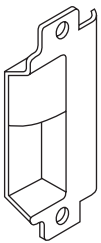

#### Open Back Strike

Optional for use with ED5600 x vertical rod devices on a pair of doors. Non-handed, 4-7/8" x 1-1/4" (124mm x 32mm). Black finish. To order with exit device, specify SB134 for 1-3/4" doors, SB214 for 2-1/4" doors. To order separately, specify Part No.

Door Thickness	Type	Part No.
1-3/4" (44mm)	Curved lip	653L183016
	Straight lip	653L163016
2-1/4" (57mm)	Curved lip	653L183020
	Straight lip	653L163020



#### Mortise Strike

Standard on ED5600 and ED5600A devices on 2" (51mm) (D200) and 2-1/4" (57mm) (D214) thick doors. Handed ANSI curved lip, 4-7/8" x 1-1/4" x 1-1/2" (124mm x 32mm x 38mm) lip to center. Black finish. To order separately, specify 656L677024 for LHR doors, 656L687024 for RHR doors.



#### ANSI Wrought Strike Box

Optional for use with ED5600 and ED5600A devices. To order with exit device, specify M17. To order separately, specify 120F76-8.

### Filler Plates



Optional for use on stock metal doors when required. To order, specify 334F99-8 600.



Optional for use on stock metal doors when required. To order, specify 236L708018 x Fin.

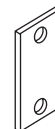

Optional for use on stock metal doors when required. To order, specify 077F19-8 600.

# Facts & Figures

## ED5000 Series

### ED5000 Series (all variables)

Series	"A"	"B"
ED5000 ED5000A	32-7/8" (835mm)	18" (457mm)
ED5000 x W048 ED5000A x W048	44-7/8" (1140mm)	24" (610mm)
ED5000 x W024 ED5000A x W024	20-7/8" (530mm)	12" (305mm)

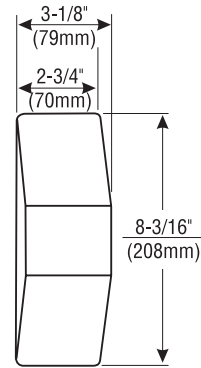

Cover Detail

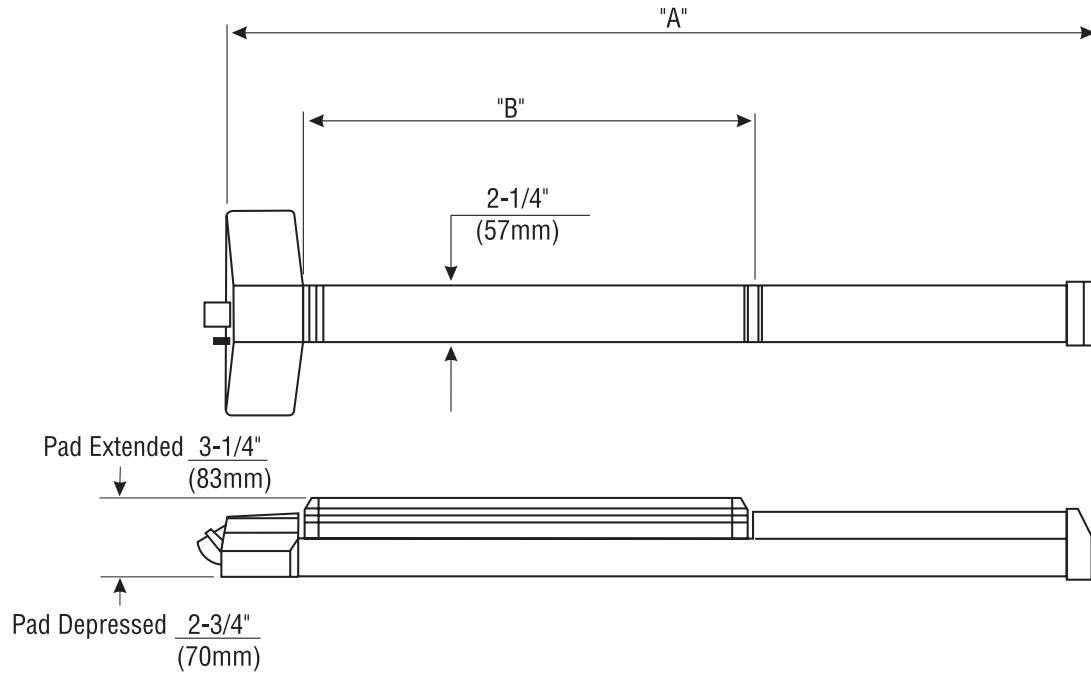

# Cylinders

## ED5000 Series

### CR700 Series KRM\* & Cylinder Dogging, Delayed Egress, and Alarm

Mortise cylinders

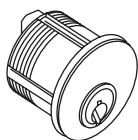

Description	Part Number	Delayed Egress, Alarm, Cylinder Dogging Collars	Key Removable Mullions*	
			Part Number	Cylinder Collar
6-pin	CR1000-118-A02	N/A	CR1000-118-A02	None Required
7-pin	CR1000-114-A02-7	270F15	CR1000-114-A02-7	None Required
6-pin SFIC	CR1050-114-A02	270F15	None Required	None Required
7-pin SFIC	CR1050-112-A02-7	654F07	None Required	None Required
6-pin, SFIC, less core	CR1040-114-A02	270F15	None Required	None Required
7-pin, SFIC, less core	CR1040-112-A02-7	654F07	None Required	None Required
6-pin, LFIC	CR1080-114-A02	270F15	CR1080-114-A02	None Required
7-pin, LFIC	CR1080-112-A02-7	654F07	CR1080-112-A02-7	447F42
6-pin, LFIC, less core	CR1070-114-A02	270F15	CR1070-114-A02	None Required
7-pin, LFIC, less core	CR1070-112-A02-7	654F07	CR1070-112-A02-7	447F42
6-pin, Security	CR1010-118-A02	N/A	CR1010-118-A02	None Required
6-pin, Security IC	CR1090-114-A02	270F15	CR1090-114-A02	None Required
7-pin, Pyramid Security	CR1027-114-A02	270F15	CR1027-114-A02	None Required
7-pin, Pyramid Security IC	CR1037-114-A02	270F15	CR1037-114-A02	None Required
7-pin, Pyramid High Security	CR1020-114-A02	270F15	CR1020-114-A02	None Required
7-pin, Pyramid IC High Security	CR1030-114-A02	270F15	CR1030-114-A02	None Required

\*The 700 series key removable mullion was discontinued on January 1, 2010. The cylinders and cylinder rings are listed for reference only.

### CR900 Series Trim

Rim cylinders

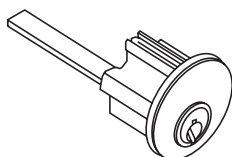

Description	Part Number	Cylinder Collar	57 Function Part Number	Cylinder Collar**
6-pin	CR3000-058	None Required	CR3000-200N*	None Required
7-pin	CR3000-058-7	686F98	CR3000-200-7	422F88
6-pin SFIC	CR3050-058	422F88	None Required	None Required
7-pin SFIC	CR3050-058-7	686F98	None Required	None Required
6-pin, SFIC, less core	CR3040-058	422F88	None Required	None Required
7-pin, SFIC, less core	CR3040-058-7	686F98	None Required	None Required
6-pin, LFIC	CR3080-058	422F88	CR3080-178	422F88
7-pin, LFIC	CR3080-058-7	686F98	CR3080-178-7	686F98
6-pin, LFIC, less core	CR3070-058	422F88	CR3070-178	422F88
7-pin, LFIC, less core	CR3070-058-7	686F98	CR3070-178-7	686F98
6-pin, Security	CR3010-058	None Required	CR3010-200	422F88
6-pin, Security IC	CR3090-058	422F88	CR3090-178	422F88
7-pin, Pyramid	CR3020-058	422F88	CR3020-200N	422F88
7-pin, Pyramid IC	CR3030-058	422F88	CR3030-178	422F88
7-pin, Pyramid Security	CR3027-058	422F88	CR3027-200N	422F88
7-pin, Pyramid Security	CR3037-058	422F88	CR3037-178	422F88

\*For K157, substitute -200

\*\*K157 uses the 270F15 cylinder ring

### CR900 Series KRM

Mortise cylinders

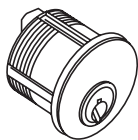

CR900 Series KRM  
Mortise cylinders

Description	Part Number	Quick Code	900 Series Cylinder Collar			WS700 Series Cylinder Collar		
			1-1/8"	1-1/4" or 1-1/4" IC	1-1/2" IC	1-1/8"	1-1/4" or 1-1/4" IC	1-1/2" IC
6-Pin	CR1000-118-A62	6P						
7-Pin	CR1000-114-A62-7	7P						
6-Pin SFIC	CR1050-114-A62	C6S						
7-Pin SFIC	CR1050-112-A62-7	C7S						
6-pin, SFIC, less core	CR1040-114-A62	SFIC						
7-pin, SFIC, less core	CR1040-138-A62-7	SFIC						
6-Pin, LFIC	CR1080-114-A62	C6						
7-Pin, LFIC	CR1080-112-A62-7	C7						
6-pin, LFIC, less core	CR1070-114-A62	CL6	610F01*	447F43*	609F37*	447F42*	610F01*	609F36*
7-pin, LFIC, less core	CR1070-112-A62-7	CL7						
7-pin, Pyramid High Security	CR1020-114-A62	PHS						
7-pin, Pyramid Security	CR1027-114-A62	PS						
7-pin, Pyramid High Security IC	CR1030-114-A62	PCHS						
7-pin, Pyramid Security IC	CR1037-114-A62	PCS						
Security	CR1010-118-A62	HS						
Security IC	CR1090-114-A62	CHS						

\*Specify Finish

# Cylinders

## ED5000 Series

### CR900 Series Mortise Trim Mortise cylinders

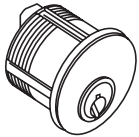

Description	Part Number	Cylinder Collar
6-pin	CR1000-134-A02	598F89
7-pin	CR1000-134-A02-7	598F89
6-pin, SFIC	CR1050-134-A02	598F89
7-pin, SFIC	CR1050-134-A02-7	598F89
6-pin, SFIC, less core	CR1040-134-A06	598F89
7-pin, SFIC, less core	CR1040-134-A02-7	598F89
6-pin, LFIC	CR1080-134-A02	598F89
7-pin, LFIC	CR1080-134-A02-7	598F89
6-pin, LFIC, less core	CR1070-134-A02	598F89
7-pin, LFIC, less core	CR1070-134-A02-7	598F89
6-pin, Security	CR1010-134-A02	598F89
6-pin, Security IC	CR1090-134-A02	598F89
7-pin, Pyramid IC High Security	CR1030-134-A02	598F89
7-pin, Pyramid Security IC	CR1037-134-A02	598F89

### Inside Cylinder For ED5602 Double Cylinder Exit Device Rim cylinders

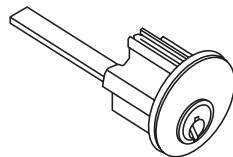

ED5602 Double Cylinder Exit Device  
Rim cylinders

Description	Part Number	Cylinder Collar
6-pin	CR3000-200	270F15
7-pin	CR3000-200-7	654F07
6-pin, IC	CR3080-178	654F07
7-pin, IC	CR3080-178-7	654F08
6-pin, IC, less core	CR3070-178	654F07
7-pin, IC, less core	CR3070-178-7	654F08
6-pin, Security	CR3010-200	654F07
6-pin, Security IC	CR3090-178	654F07
7-pin, Pyramid	CR3020-200	654F07
7-pin, Pyramid IC	CR3030-178	654F07
7-pin, Pyramid Security	CR3027-200	654F07
7-pin, Pyramid Security	CR3037-178	654F07

### ED5202 Double Cylinder Exit Device Rim cylinders

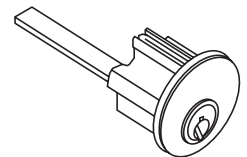

ED5202 Double Cylinder Exit Device  
Rim cylinders

Description	Part Number	Cylinder Collar
6-pin	CR3000-138	270F15
7-pin	CR3000-138-7	654F07
6-pin, IC	CR3080-114	654F07
7-pin, IC	CR3080-114-7	654F08
6-pin, IC, less core	CR3070-114	654F07
7-pin, IC, less core	CR3070-114-7	654F08
6-pin, Security	CR3010-138	654F07
6-pin, Security IC	CR3090-114	654F07
7-pin, Pyramid	CR3020-138	654F07
7-pin, Pyramid IC	CR3030-114	654F07
7-pin, Pyramid Security	CR3027-138	654F07
7-pin, Pyramid Security	CR3037-114	654F07

Note: Cylinder collar packets contain a collar and spring washer.  
\*Specify finish when ordering packets.

### Rim Thumbturn

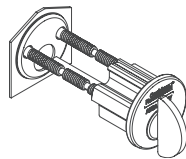

Description	Part Number
Rim Thumbturn - 1-3/8"	CR3300 -138
Rim Thumbturn - 1-3/8" - Ergonomic	CR3300-138-M34
Rim Thumbturn - 2"	CR3300-200
Rim Thumbturn - 2" - Ergonomic	CR3300-200-M34

### CR900 Series KRM Cylinder Collar Packet

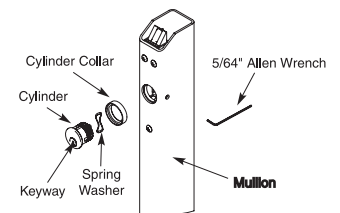

Mullion Series	Cylinder Length and Type			
	1-1/8"	1-1/4"	1-1/4" IC	1-1/2" IC
CRWS707AKM CRWS708AKM	447F42*	610F01*	609F36*	
CR907BKM CR908BKM CR910KM	610F01*	447F43*	609F37*	

# Quick Codes

## ED5000 Series

### Cylinder and Keying

Description	Specify
Conventional 6-pin	6P
Conventional 7-pin	7P
<b>LFIC</b>	
LFIC 6-pin	C6
LFIC 6-pin less core	CL6
LFIC 6-pin with temporary construction core (Red)	CT6R
LFIC 6-pin with temporary construction core (Blue)	CT6B
LFIC 6-pin with temporary construction core (Green)	CT6G
LFIC 6-pin with temporary disposable core	CT6D
LFIC 7-pin	C7*
LFIC 7-pin less core	CL7*
LFIC 7-pin with temporary construction core (Red)	CT7R*
LFIC 7-pin with temporary construction core (Blue)	CT7B*
LFIC 7-pin with temporary construction core (Green)	CT7G*
LFIC 7-pin with temporary disposable core	CT7D*
<b>SFIC</b>	
SFIC 6-pin	C6S
SFIC 6-pin with temporary construction core (Blue)	CT6SB
SFIC 6-pin with Less Core	CLS6
SFIC 6-pin with SFIC disposable temporary core	CT6SD
SFIC 7-pin	C7S
SFIC 7-pin with temporary construction core (Blue)	CT7SB
SFIC 7-pin with Less Core	CLS7**
SFIC 7-pin with SFIC disposable temporary core	CT7SD*
<b>Security</b>	
Security	HS
Security IC	CHS
<b>Access 3®</b>	
Access 3® - Patented	AP
Access 3® - Security	AS
Access 3® - High Security	AHS
Access 3® IC - Patented	ACP
Access 3® IC - Security	ACS
Access 3® IC- High Security	ACHS
<b>Pyramid</b>	
Pyramid Security fixed core	PS
Pyramid Security IC	PCS
Pyramid High Security fixed core	PHS
Pyramid High Security IC	PCHS
Pyramid IC with temporary construction core	CTP
Pyramid IC with temporary disposable core	CTPD
Pyramid IC less core	CLP
<b>Keying and Keys</b>	
0-bitted with 2 blank keys	(standard)
Keyed random	KR
Construction master keyed	CMK
2 keys per lock	(standard)
More than 2 keys	KY# (e.g., KY6)
<b>Visual key control (VKC)</b>	
No keying data stamped on key or cylinder	VKC0
Keys only	VKC1
Cylinders and keys (not for HS, CHS, PHS or PCHS)	VKC2
Cylinders only (not for HS, CHS, PHS or PCHS)	VKC3
<b>Concealed key control (CKC)</b>	
CKC cylinders with VKC keys	CKC2
CKC cylinders only (not for HS, CHS, PHS or PCHS)	CKC3

### Strikes

Description	Specify
Rim x vertical rod on pairs of doors	S02
Surface and concealed vertical rod Bottom strike for 1/2" thresholds or flush mount	S09
Mortise ANSI strike for pairs of doors with astragal	SS078
Open back strike for 1-3/4" doors	SB134
Open back strike for 2-1/4" doors	SB214

### Door Height

Door Height	Specify
ED5400(A) and ED5470(B) devices	
7'0"	(standard)
7'2"	H0702
7'6"	H0706
8'0"	H0800
ED5800(A) devices	
8'0"	(standard)
ED5470(B), ED5860(B) devices only	
9'0"	H0900
10'0"	H1000

### Door Width

Door Width	Specify
24" (610mm)	W024
36" (914mm)	(standard)
48" (1219mm)	W048

### Door Thickness

Door	Specify
1-3/4" (44mm)	(standard)
2" (51mm)	D200
2-1/4" (57mm)	D214



# Quick Codes

## ED5000 Series

### Finish

Description		Specify
US3	Bright Brass	605
US4	Satin Brass	606
US9	Bright Bronze	611
US10	Satin Bronze	612
US10B	Dark Oxidized Satin Bronze, oil rubbed	613
10BE	Dark Oxidized Satin Bronze Equivalent	613E
US14	Bright Nickel Plated	618
US15	Satin Nickel Plated	619
US26	Bright Chromium Plated	625
US26D	Satin Chromium Plated	626 <sup>1</sup> (Trim only)
	Satin Chromium Plated with MicroShield®	626C <sup>2</sup>
US32	Bright Stainless Steel	629
US32D	Stain Stainless Steel	630
	Stain Stainless Steel with MicroShield®	630C <sup>2</sup>
—	Black oxidized bronze, oil rubbed	722
—	Black Suede Powder Coat	BSP
—	White Suede Powder Coat	WSP

1. Contact factory for devices required in BHMA 626  
2. Finish available with MicroShield® antimicrobial coating.

### Lock Finish

Description	Cylinder/Core*
605,606,611,612,613,613E,722	606
618,619,625,626,626C,629,630,630C,WSP	626
BSP	BSP

\*Finish when cylinder provided with lock

### Miscellaneous Options

Description	Specify
Torx® head screws	M04
ANSI wrought strike box (mortise)	M17
Knurling outside and inside (embossed touchbar - device side) <sup>1</sup>	M20
Knurling outside only (trim side) <sup>1</sup>	M21
Knurling inside only (embossed touchbar - device side)	M22
Abrasive coat outside and inside (trim and device)	M23
Abrasive coat inside only (device side)	M24
Abrasive coat outside only (trim side)	M25
24", 36" and 48" PathLite™ Photoluminescent Touchbar Cover	M49
Less dogging	M51
Cylinder dogging	M52
Sex nuts and bolts (SNBs)	M54
Less bottom vertical rod (ED5470(B)/ED5860(B) Only)	M55
Narrow Stile Cover	M56
Mullion stabilizer	M57
Shim kit (for vision light)	M58
Parabolic escutcheon	M60
Wood screws for use on fire-rated solid wood or wood core doors	M64
Flush transom top strike bracket (ED5400 and ED5400A only)	M67
Schlage cam and HSG assembly <sup>6</sup>	M69
Door frame filler block for double rabbeted frames	M95
Door frame angle bracket for aluminum frames	M96
Windstorm Certified products for ED5200S(A) and ED5470(B) Only <sup>2,3,4,5</sup>	M107
High Impact End Clamp	M109
Flush End Cap	M110
5LB pressure release (ED5200 only)	5CH

#### Notes:

- Not available with VT9, VTL9, VT9M and VTL9M trim.
- ED5200S(A) x M107 requires through bolts.
- ED5470(B) maximum opening height is 8'0".
- Contact Ceco, Curries® or Fleming for detailed frame/door requirements and limitations.
- Not available with electric dogging (M97).
- M69 available for 950 series trim only.

### Handing

Hand	Specify
Right Hand Reverse	RHR
Left Hand Reverse	LHR

# Quick Codes

## ED5000 Series

### Key Removable Mullions

Description	Specify
Up to 7'0" Steel Mullion - 1-1/2 Hour Fire Rated	CR907BKM <sup>1</sup>
Up to 8'0" Steel Mullion - 1-1/2 Hour Fire Rated	CR908BKM <sup>1</sup>
Up to 10'0" (ED5200, ED5200S only) Steel Mullion - Panic Rated	CR910KM <sup>1</sup>
Up to 7'0" Steel Mullion - 3 Hour Fire Rated, Windstorm Certified	CRWS707AKM <sup>1</sup>
Up to 8'0" Steel Mullion - 3 Hour Fire Rated, Windstorm Certified	CRWS708AKM <sup>1</sup>

Note:

1. For use with UL listed door assemblies that comply to FEMA 361 and FEMA 320 guidelines. For the latest listings on compliant door assemblies visit our website at [corbinrusswin.com](http://corbinrusswin.com)

### Removable Mullions

Description	Specify
Up to 7'0" Steel Mullion - Panic Rated	CR907
Up to 8'0" Steel Mullion - Panic Rated	CR908
Up to 10'0" (ED5200, ED5200S only) Steel Mullion - Panic Rated	CR910
Up to 7'0" Steel Mullion - 3 Hour Fire Rated	CR907A
Up to 8'0" Steel Mullion - 3 Hour Fire Rated	CR908A
Up to 7'0" Steel Mullion - 3 Hour Fire Rated, Windstorm Certified	CRFE707A <sup>1</sup>
Up to 8'0" Steel Mullion - 3 Hour Fire Rated, Windstorm Certified	CRFE708A <sup>1</sup>

Note:

1. Cylinder and collars not included, specify separately. See page 54.

### Electrified Options for Exit Devices

Description	Specify
Motorized Electric Latch Retraction	MELR
Exit Alarm Device (cylinder not included)	M61
Bolt Position Monitoring	M91
Request to Exit/Touchbar Monitoring or Signaling	M92
Outside Trim Monitoring or Signaling	M93
Electric Dogging	M97
Mortise Device Lock with Outside Trim Control (Fail Safe)	SAF*
Mortise Device Lock with Outside Trim Control (Fail Secure)	SEC*
Delayed Egress (15 second delay standard)	D
30 second delay (may be accepted by local jurisdiction) (with "D" option only)	M88
BOCA 15-second delay (with "D" option only)	M89
BOCA 30-second delay (with "D" option only)	M90
Security Monitor	M98 <sup>^</sup>
Trim Gasket	M99

\*Only available with ED5600L and 5600(A)L  
<sup>^</sup>9903/9905 trims only.

### Electrified Accessories

Description	Part Number
Controller (Required for Electric Latch Pullback(M94))	782
Power supply 1.0 Amp @ 12 VDC output	BPS-12-1
Power supply 3.0 Amp @ 12 VDC output	BPS-12-3
Power Supply 1 Amp @ 24 VDC Output	BPS-24-1
Power Supply 2 Amp @ 24 VDC Output	BPS-24-2
Power Supply 4 Amp @ 24 VDC Output	BPS-24-4
SPDT Maintained Switch	MKA
SPDT Momentary Switch	MK
SPDT Momentary NS Switch	MKN
DPDT Momentary Switch	MK2
DPST Maintained (Al. Action) Switch	PB3EA
Sonalert 90lbs. @ 2 ft. 12-24VDC mounted on one gang stainless steel plate	PZ1
Alarm Kit (cylinder is not included)*	ED50AK
Concealed transfer for over 120° swing doors	EPTL

# How to Order

## ED5000 Series

### Ordering Examples

#### Exit Device Only\*

Quantity	Series/ Function	Finish	Hand	Misc. Options
65	ED5200S	626	RHR	M51

\*To order mortise exit device only, see Mortise Exit Only below.

### Where to find ordering information and Quick Codes

Functions and Trims	Strike .....	Pg 55
Rim and	Finish .....	Pg 56
Vertical Rod .....	Door Thickness.....	Pg 56
Mortise .....	Handing.....	Pg 56
Cylinders and Keying..	Miscellaneous	
Door Height.....	Options.....	Pg 56
Door Width.....	Removable Mullion ....	Pg 57

#### Trim Only

Quantity	Trim/ Function	Finish	Hand	Door Thickness
24	N955ET	625	RHR	D214

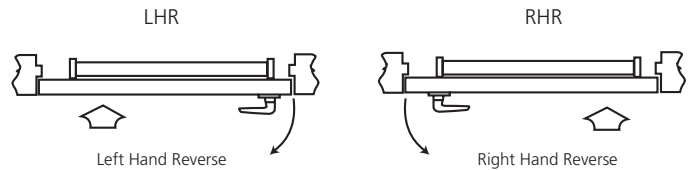

Note: Arrow (  ) indicates secure side of door.

#### Exit Device with Trim

Quantity	Exit Device	Trim/ Function	Finish	Hand	Door Thickness	Optional Strike	Door Width	Misc. Options
65	ED5600L	N9M55ET	605	LHR	D214	SB214	W048	M51-M54

#### Contract/Detailed Order – Surface Vertical Rod Exit Device with Trim

Quantity	Exit Device	Trim/ Function	Finish	Hand	Door Height	Door Width	Misc. Options	Cylinder Option	Keyset
36	ED5470	C955ET	626	LHR	H1000	W048	M52-M54	7P	AA1

#### Mortise Exit Only

Trim Type	Functions	Panic	Fire
Lever or Flat Plate	Passage	ED5600L	ED5600AL
	Classroom		
	Double Cylinder (Classroom function lever Trim only)	ED5602L	ED5602AL
	Nightlatch	ED5657L	ED5657AL
Thumbpiece	Dummy	ED5600T	ED5600AT
	Passage		
	Classroom		
	Nightlatch	ED5657T	ED5657AT
	Dummy		

#### Removable Mullion

Quantity	Mullion	Misc. Options
6	CR908A	M96

# How to Order the Muséo® Piet Levers

## ED5000 Series

### Muséo® Piet Lever Collection Trim and Finish Options



**Grooved Insert**  
21G



**Leather Insert**  
21L



**Polished with Satin Insert**  
21M



**Santoprene™ Insert**  
21S



**With Raised Band**  
23M



**Plain**  
25M



**Plain with Two Grooves**  
27M

### Piet Finish Codes

BHMA/ASSA ABLOY Finish	Piet Code*	Description
630	30	Satin Stainless Steel
629	29	Bright Stainless Steel
613E	3E	Dark Oxidized Satin Bronze, Equivalent
BSP	BS	Black Suede Powder Coat
WSP	WS	White Suede Powder Coat
N/A	BK	Black (Santoprene™ or leather insert)
N/A	BN	Brown (leather insert)
N/A	00	No Insert

\*Code used to specify Piet Collection finishes only. Use available finishes list to specify desired finish when ordering.

### Piet Lever Descriptions & Available Finishes

Lever Designation	Lever Description	Available Finishes (as ordered)
21G	Grooved Insert	292929, 303030, 3E003E, BS00BS, WS00WS
21L	Leather Insert	29BK29, 29BN29, 30BK30, 30BN30, 3EBK3E, 3EBN3E, BSBKBS, BSNBBS, WSBKWS, WSNBWS
21M	Metallic Insert	293029** only
21S	Santoprene Insert	29BK29, 30BK30, 3E003E, BS00BS, WS00WS
23M	Raised Band	290029, 300030, 290030**, 3E003E, BS00BS, WS00WS
25M	Plain	290029, 300030, 3E003E, BS00BS, WS00WS
27M	Two Grooves	290029, 300030, 3E003E, BS00BS, WS00WS

\*\*Two-tone finish - grip of lever is 630, balance of lever is 629. Escutcheon finish will be 618.

### Ordering Examples

#### Trim Only

Quantity	Trim/Function	Lever Finish	Hand
2	21M910	293029	RHR

In this example the escutcheon finish will be supplied in 618.

#### Exit Device with Trim

Quantity	Exit Device	Trim/Function	Lever Finish	Exit Bar Finish	Hand	Cylinder Option	Door Thickness	Optional Strike	Door Width
2	ED5600A	21G9M10	303030	630	LHR	6P	D200	SB214	W048

# Helpful Terms

## ED5000 Series

### **Abrasive Coat**

Hard granular material applied to provide a non-slip tactile surface for the visually impaired.

### **Active Door**

In a pair of doors, the door that is operable from the trim side.

### **Astragal**

A vertical member applied to one or both sides of a pair of doors at the meeting edges. The astragal closes the gap between the two doors.

### **Coordinator**

A device used on a pair of doors to ensure that the inactive door closes before the active door.

### **Deadlocking Latch**

A supplemental latch that automatically deadlocks the latchbolt when pressure is applied to it.

### **Dogging**

A mechanism that allows the latchbolt to remain retracted, permitting the door to operate as if it were a push-pull; it cannot be used on fire-rated exit devices.

### **Double Egress**

A pair of doors of the same hand that swing in opposite directions, commonly found in corridors.

### **Dummy Trim**

Trim only. Usually used on the inactive door of a pair of doors for design balance.

### **Exit Device (Panic Hardware)**

A door locking device with a pushpad or crossbar which, when pressed, allows instant exit (egress).

### **Fire Exit Hardware**

An exit device listed by an independent testing laboratory as meeting panic, fire and hose stream test standards; used on fire-rated openings.

### **Hand**

The direction a door swings.

### **Inactive Door**

In a pair of doors, the door that is inoperable from the trim side.

### **Latchbolt**

A lock component that has a beveled end and projects into a strike, holding the door in a closed position.

### **Mullion**

A fixed or removable vertical member that divides a door opening and provides a latch surface for a pair of rim exit devices.

### **Open Back Strike**

For mortise exit devices, used on the inactive door (usually the vertical rod door) of a pair of doors that swing in the same direction. It permits the inactive door to open or close independently.

### **Reversible**

Pertains to a product that may be changed in the field to accommodate any hand of the door.

### **Shim Kit**

Pieces of metal that permit mounting of an exit device on a door that has a surface projecting vision light (glass bead) molding.

### **Split Astragal**

An astragal that is split through the middle on a pair of doors, allowing both doors to operate independently.

### **Threshold**

A strip fastened to the floor beneath a door. It serves as a stop, prevents heat loss, and provides a strike location for latching the bottom rod of a vertical rod exit device.

### **Trim**

Lever, pull, or thumbpiece used on the outside of an exit device door to control access to an area.

### **Universal Exit Device**

An exit device that may be used on doors of either hand without any modifications.

## **Keying and Cylinder Terms**

### **Concealed Key Control (CKC)**

The marking of standard key symbols on a cylinder in a location that is not visible once the cylinder is installed.

### **Construction Master Keying (CMK)**

A cylinder preparation that allows temporary access by construction personnel.

### **Control Key**

A key used to remove and install interchangeable cores.

### **Cylinder**

A lock component containing the combination that determines which keys will operate.

### **Security Cylinder**

A cylinder which provides extra resistance to picking and unauthorized duplication of keys.

### **Interchangeable Core (IC)**

A cylinder which can be removed and installed quickly with a control key by non-skilled personnel when rekeying is required.

### **Key Symbol**

A letter/number combination in standard industry format (e.g., 1AA, AA1, etc.) which indicates exactly how a key or cylinder fits into a keying system.

### **Keyway**

The opening in a cylinder plug through which the key enters.

### **Master Keying**

Preparation of a cylinder to operate with keys of different levels of access.

### **Visual Key Control (VKC)**

The marking of standard key symbols on keys and on the visible portion of the front of a cylinder.

# How to Specify

## ED5000 Series

### Suggested Specification for Panic and Fire-Rated Exit Devices

Exit devices shall be ED5000 Series Pushpad Exit Devices as manufactured by Corbin Russwin Architectural Hardware.

The exit device chassis shall be cold forged steel, electroplated for corrosion resistance, and shall be architecturally finished brass, bronze or stainless steel. The pushpad mechanism shall be constructed of extruded aluminum and shall be scalped with architecturally finished brass, bronze or stainless steel. The maximum projection shall be 3-1/4" when the pushpad is active and 2-3/4" when the pushpad is dogged down. Nylon bearings and stainless steel springs shall be used for long life and durability; only torsion springs are acceptable. Rear and active case covers shall be wrought brass or bronze and shall be plated to match the exit bar. Plastic or painted covers are not acceptable. Latchbolts shall be steel and shall incorporate a deadlocking latch for increased security. Devices without deadlocking latches are not acceptable. Mounting screws shall be concealed to deter tampering. Devices shall be closed on all sides with no pinch points. All exit devices shall be easily field sized to accommodate various door widths.

Panic-listed exit devices shall have single-point, one quarter turn hex key dogging standard. Optional cylinder dogging shall be available on panic listed devices only. Devices with hex key dogging shall be easily field converted to cylinder dogging. Panic-listed devices shall be available less dogging.

Trims shall be through-bolted with concealed fasteners. Escutcheon and pull type trims shall be constructed of brass or bronze. All lever trims shall use cast or forged levers. On trims with cylinders, the mechanism that locks and unlocks the trim shall be housed in the trim and not in the active case of the exit device. Rim and vertical rod lever trims shall be Free Wheeling with clutch mechanism allowing lever to rotate 60° when locked for ideal protection. Lever trims shall match those on Corbin Russwin Mortise and Cylindrical Locksets.

Exit devices and trims shall be furnished in BHMA standard architectural finishes.

Exit devices shall be listed by Underwriters Laboratories (UL) for safety as panic hardware. Fire-rated devices shall be listed for A label and lesser class doors.

Certification:  
ANSI A156.3, Grade 1

Devices, trims and cylinders shall be from one manufacturer.

Devices and 900 series trim shall carry a five-year limited warranty.

Electronic components shall carry a two-year limited warranty / Motorized electric latch retraction (MELR) shall carry a 5 year warranty.

# How to Specify

## ED5000 Series

### Suggested Specification for Delayed Egress Exit Devices

Delayed egress exit devices shall be ED4000/ED5000 series (rim, SecureBolt®, mortise or concealed vertical rod) with the "D" suffix, manufactured by Corbin Russwin Architectural Hardware.

The delayed egress exit device secures the door in the locked mode. Depressing the pushpad for less than three seconds will sound the device nuisance beep without initiating the alarm. Depressing the pushpad longer than three seconds will initiate an irreversible local audible beeping tone and allow the device to release for egress after 15 seconds (or 30 seconds may be accepted by local jurisdiction) and sound the alarm. The alarm will continue until reset by the mechanical key switch located on the device.

Devices shall be 24 volts DC.

The exit device chassis shall be cold forged steel, electroplated for corrosion resistance, and shall be architecturally finished brass, bronze or stainless steel. The pushpad mechanism shall be constructed of extruded aluminum and shall be scalped with architecturally finished brass, bronze or stainless steel. The maximum projection shall be 3-1/4" when the push pad is active and 2-3/4" when the push pad is depressed. Nylon bearings and steel springs shall be used for long life and durability. Active case and alarm end cover shall be wrought brass, bronze or stainless steel and shall be plated to match the exit bar. Painted or plastic covers or end caps are not acceptable. Latch bolts shall be steel and shall incorporate a deadlocking latch for increased security. Devices without deadlocking latches are not acceptable. Mounting screws shall be concealed to deter tampering. Devices shall be closed on all sides with no pinch points. Device active cover and end cap attaching screws shall be security Torx® pin.

Trims shall be through-bolted with concealed fasteners. Escutcheon and pull-type trims shall be constructed of brass, bronze or stainless steel. All lever trims shall use cast or forged levers. On trims with cylinders, the mechanism that locks and unlocks the trim shall be housed in the trim and not in the active head of the Exit Device. Rim and vertical rod lever trims shall be Free Wheeling with clutch mechanism allowing lever to rotate 60° when locked for ideal protection. Lever trims shall match those on Corbin Russwin mortise and cylindrical locksets.

Devices shall be listed by UL/cUL as Controlled Exit Panic Devices or Special Locking Arrangement and meet all requirements for NFPA 101.

Certification:  
ANSI 156.3, Grade 1/ANSI 156.24  
UL/cUL FUKD/FUKD7 - Controlled Panic Device  
UL/cUL FWAX/FWAX7 - Special Locking Arrangements

Exit devices, trims and cylinders must be from one manufacturer.

Exit devices and heavy-duty trims shall have a five-year warranty. Electronics shall have a two-year warranty / Motorized electric latch retraction (MELR) shall carry a 5 year warranty.



The ASSA ABLOY Group is the global leader in access solutions. Every day, we help billions of people experience a more open world.

ASSA ABLOY Opening Solutions leads the development within door openings and products for access solutions in homes, businesses and institutions. Our offering includes doors, frames, door and window hardware, locks, perimeter fencing, access control and service.



For additional information, contact your  
ASSA ABLOY Door Security Solutions  
sales consultant or visit [www.corbinrusswin.com](http://www.corbinrusswin.com).

**In U.S.**

Corbin Russwin  
225 Episcopal Road  
Berlin, CT 06037  
Phone: 800-543-3658  
Fax: 800-447-6714  
[www.corbinrusswin.com](http://www.corbinrusswin.com)

**In Canada**

ASSA ABLOY Door  
Security Solutions Canada  
160 Four Valley Drive  
Vaughan, Ontario  
Canada L4K 4T9  
Phone: 800-461-3007  
Fax: 800-461-8989  
[www.assaabloydss.ca](http://www.assaabloydss.ca)

**MicroShield®**

As part of their promise to provide innovative solutions to their customers, certain ASSA ABLOY Group brands offer the MicroShield® technology, a silver-based antimicrobial coating designed to inhibit the growth of bacteria.

Microshield® is a registered trademark of ASSA ABLOY Access and Egress Hardware Group, Inc.



The Agion antimicrobial is not intended as a substitute for good hygiene. Coated products must still be cleaned to ensure the surfaces will be free of destructive microbes. ASSA ABLOY makes no representations or warranties, express or implied, as to the efficacy of the Agion antimicrobial. A copy of the Agion warranty is available upon request. Agion is a registered trademark of Agion Technologies, Inc., Wakefield, MA, USA.