



CL3800 Series

Standard-Duty Key-in-Lever Locksets



Product Catalog

Experience a safer
and more open world

Applications

CL3800 Series

Table of Contents

Applications	2
Features	3
Functions	4
Trim Designs	5
Options & Accessories	6-8
How to Order	9
Quick Codes	10-11
How to Specify	12

An economical, Grade 2 standard-duty lever lockset which provides an outstanding combination of value and performance. It's the ideal lever lockset for standard commercial applications. When used in conjunction with the CLX3300 Series Extra Heavy-Duty Grade 1 Cylindrical Lever Locksets, the overall cost of many projects may be reduced without compromising functionality and durability.



Typical applications include:

- Interior offices
- Closets
- Multi-family housing
- Restaurants
- Retail complexes

Advantages

- Lever Release™ for vandal resistance
- Solid cast levers
- ANSI/BHMA Grade 2 certification
- UL-cUL 3-hour fire rating
- Independent lever return springs
- Thrubolts on door for solid attachment
- Covers ANSI/BHMA door prep A156.115

www.corbinrusswin.com

Features

Handing

Non-handed.

Door Thickness Adjustment

Standard 1-3/8" to 1-7/8" (35 to 48mm); factory set for 1-3/4" doors. For 2" (51mm) and 2-1/4" (57mm) doors, specify door thickness. See Quick Codes, page 11.

Lock Chassis

Steel, zinc dichromated for corrosion resistance.

Backset

2-3/4" (70mm) standard. Optional: 2-3/8" (60mm), 3-3/4" (95mm) and 5" (127). See Quick Codes, page 11.

Latchbolt

1/2" (13mm) throw latch with universal "floating" front to fit both flat and beveled doors. 2-1/4" x 1-1/8" (57 x 29mm) square corner front for 2-3/4" (70mm) backset standard. For other latch options, See Quick Codes, page 11.

Auxiliary Latchbolt

Deadlocking latchbolt prevents manipulation when door is closed.

Strike

ANSI curved lip strike standard, 4-7/8" x 1-1/4" x 1-1/4" (124 x 32 x 32mm) lip to center. Optional strikes, lip lengths and ANSI wrought strike box available; See Quick Codes, page 11.

Cylinder

Brass, 6-pin, L4 keyway, "0" bitted standard.

Keying Features Available

Conventional 6-pin
Conventional 7-pin
Master keying
Construction master keying
Visual key control
Concealed key control
Pyramid® Security
Pyramid High Security
Interchangeable core (LFIC or SFIC)
Security
Security LFIC
Pyramid Security LFIC
Pyramid High Security LFIC
Access 3®

Keys

Two nickel silver standard.

Warranty

Five-year limited.

Vandal Resistance

All functions feature the Lever Release™ design for vandal resistance, allowing the outside lever to rotate when in the locked position.

Certification/Compliance

ANSI/BHMA BHMA

Certified A156.2 Series 4000, Grade 2. Meets A117.1 Accessibility Code.

California State Reference Code

(Formerly Title 19, California State Fire Marshal Standard)

All levers with returns comply; levers return to within 1/2" of door face.

UL-cUL

All locks listed for "A" label single doors.

Letter "F" and UL symbol on latch front indicate listing.

Any retrofit or other field modification to a fire rated opening can potentially impact the fire rating of the opening, and Corbin Russwin, Inc. makes no representations or warranties concerning what such impact may be in any specific situation. When retrofitting any portion of an existing fire-rated opening, or specifying and installing a new fire-rated opening, please consult with a code specialist or local code official (Authority Having Jurisdiction) to ensure compliance with all applicable codes and ratings.

Windstorm/Hurricane

Certified (refer to local codes).

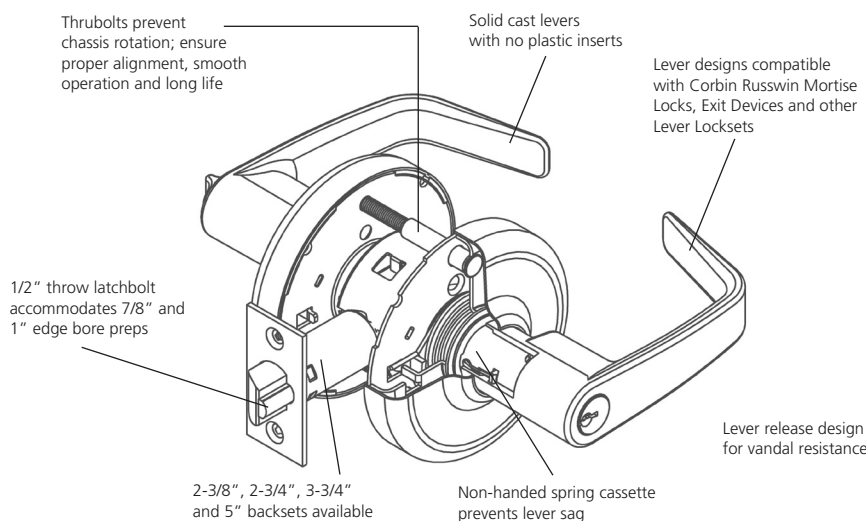

Functions

CL3800 Series

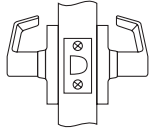
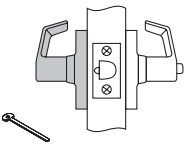
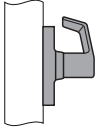
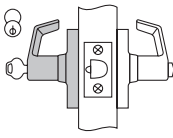
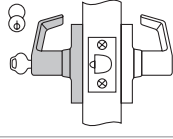
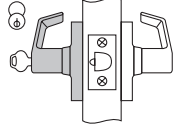
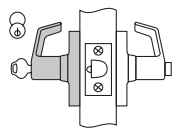
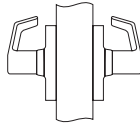
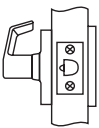
Outside	Inside	Series/Function	Type	ANSI No.	Function Description
		CL3810	Passage or Closet	F75	<ul style="list-style-type: none"> Latchbolt by lever either side Both levers always free.
		CL3820	Privacy Bedroom or Bathroom	F76A	<ul style="list-style-type: none"> Throw-off latchbolt by lever either side, except when push button locks outside lever. (Lever handle is free-wheeling in locked position.) Outside lever locked by push button. (Lever handle is free-wheeling in locked position.) Outside lever unlocked by emergency release tool, by rotating inside lever or by closing door. Inside lever always free.
		CL3850	Half Dummy Trim	—	<ul style="list-style-type: none"> Lever acts as pull only; no operation. Lever is rigid.
		CL3851	Entrance or Office	F109	<ul style="list-style-type: none"> Deadlocking latchbolt by lever either side except when turn button locks outside lever. (Lever handle is free-wheeling in locked position). Pushing turn button locks outside lever, requiring use of key outside to unlock. Turning inside lever unlocks outside lever. Pushing in and turning button locks outside lever, requiring key at all times. Turning inside lever does not unlock outside lever until button is manually turned to unlocked position. Inside lever always free.
		CL3855	Classroom	F84	<ul style="list-style-type: none"> Deadlocking latchbolt by lever either side except when key outside locks outside lever. (Lever handle is free-wheeling in locked position.) Outside lever unlocked by key outside. Inside lever always free.
		CL3857	Storeroom or Closet	F86	<ul style="list-style-type: none"> Deadlocking latchbolt by key in outside lever or by rotating inside lever. Outside lever always locked (lever handle is free-wheeling in locked position). Inside lever always free.
		CL3861	Entry or Office	F82A	<ul style="list-style-type: none"> Deadlocking latchbolt by lever either side, except when push button locks outside lever. Push button released by turning inside lever or by key in outside lever. (Lever handle is free-wheeling in locked position.) Closing door does not release push button. Inside lever always free.
		CL3870	Full Dummy Trim	—	<ul style="list-style-type: none"> Levers act as pulls only; no operation. Levers are rigid.
		CL3880	Passage Lever x Blank Plate	F111	<ul style="list-style-type: none"> Deadlocking latchbolt by lever. Lever on one side; blank plate on the other. Lever always free. For single or double communicating doors.

Trim Designs

CL3800 Series

Armstrong



AZD

Lever: Solid cast zinc
Rose: Wrought brass

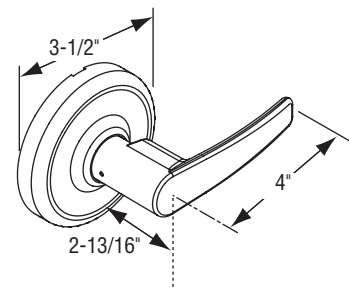

Newport

Complies with codes requiring lever to return to within 1/2" (13mm) of door face.



NZD

Lever: Solid cast zinc
Rose: Wrought brass

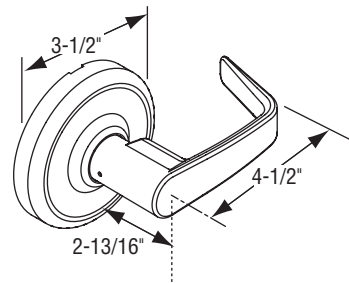

Princeton

Complies with codes requiring lever to return to within 1/2" (13mm) of door face.



PZD

Lever: Solid cast zinc
Rose: Wrought brass

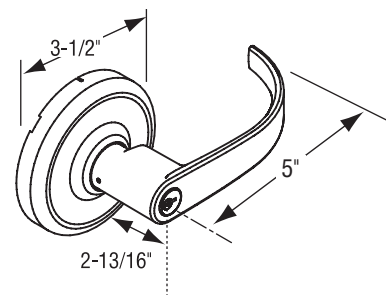

Options & Accessories

CL3800 Series

Latches

To order optional latchbolt with lockset, see How to Order, page 9.
To order latchbolt separately, specify Part No. x Finish (e.g., 599F91 x 626).

Backset and Front Description		Plain	Deadlocking	Throw-Off
2-3/8" Backset	1" width, square corner	599F91	599F92	599F93
	1" width, rounded corner	599F94	599F95	599F96
	1-1/8" width, square corner	599F97	599F98	599F99
	1-1/8" width, rounded corner	600F00	600F01	600F02
2-3/4" Backset	1" width, square corner	600F03	600F04	600F05
	1" width, rounded corner	600F06	600F07	600F08
	1-1/8" width, square corner (std)	600F09	600F10	600F11
	1-1/8" width, rounded corner	600F12	600F13	600F14
3-3/4" Backset	1-1/8" width, square corner	600F62	600F63	600F64
	1-1/8" width, rounded corner	600F65	600F66	600F67
5" Backset	1-1/8" width, square corner	600F68	600F69	600F70
	1-1/8" width, rounded corner	600F71	600F72	600F73

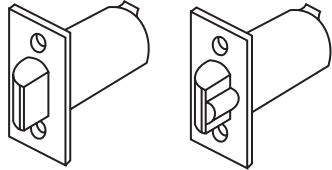

Plain (CL3810) Deadlocking (All other functions)

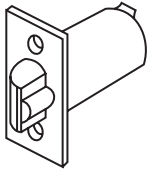

Throw-Off (CL3820, CL3893 & CL3840)

Housing diameter 7/8" for all models. 1" diameter latch sleeve furnished with each latchbolt.

Corbin Russwin Cylinders

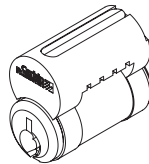
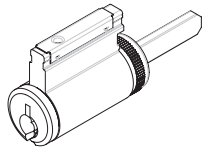

Security Type	Pins	Standard Cylinder	Large Format Interchangeable Core
Conventional	6-pin	CR2000-033 (standard)	CR8000
	7-pin	CR2000-033-7	CR8000-7
Security	6-pin	CR2010-033	CR8010
Pyramid High Security	7-pin	CR2020-033	CR8020
Pyramid Security	7-pin	CR2027-033	CR8027
Access 3® AP	6-pin	CR2500-033	CR8500
Access 3® AS	6-pin	CR2600-033	CR8600
Access 3® AHS	6-pin	CR2700-033	CR8700

Plug diameter for standard cylinders is .509, .510 for Access 3®, .552 for security cylinders and .496 for Pyramid cylinders. Cylinders are brass and come with 2 nickel silver keys.

Finishes for all cylinders and cores include 606, 626 or BSP.

To order cylinders separately, specify Part No. x Keyway x Finish (e.g., CR2000-033 x L4 x 626).

Small Format Interchangeable Core

Description	Number
6-pin	CR8200
7-pin	CR8200-7

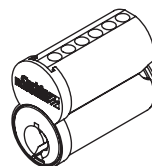

Cores are available in Best® keyways A, B, C, D, E, F, G, H, J, K, L, M.
Cores are brass and come with 2 nickel silver keys.
Finishes: 606, 626

Cylinders with Keyways From Other Manufacturers*

Competitive Keyway	Number
Schlage® C (0-bitted)	CR2400-031-C
Schlage® C (keyed random)	CR2400-031-C-KR
SARGENT® LA (0-bitted)	CR2400-031-LA

*All cylinders are 6-pin and available in 606 or 626 finish.

Levers That Accept Competitive Interchangeable Core Cylinders*

Cylinder Type	Quick Code	Tailpiece Pack Only
SFIC 6 or 7-pin (all designs)	M08 Tailpiece included	682F958
Schlage® 6-pin LFIC (NZ, PZ only)	M69 Tailpiece included	697F942

*Core not included.

Adapters Required to Accept Competitive Cylinders*

Competitive Cylinder	Quick Code	Tailpiece Pack Only
Schlage® fixed core Conventional (21-002, 23-001, 23-013) or Primus® (20-548, 20-550, 20-748, 20-750)	M06 Tailpiece included	682F398
SARGENT® fixed core C10-1	M09 Tailpiece and special lever included	682F969

*Cylinder not included.

Options & Accessories

CL3800 Series

Strikes

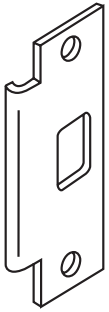

ANSI Curved Lip (standard)

Brass or stainless steel.
4-7/8" x 1-1/4" x 1-1/4" lip to center.
Optional lip lengths: 1", 1-1/8",
1-3/8", 1-1/2", 1-3/4", 2", 2-1/4", 2-1/2",
2-3/4", 3".
To order separately, specify 217L13 x Lip
Length x Finish.

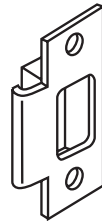

Curved Lip "T" Strike

Brass.
2-3/4" x 1-1/8" x 1-1/4" lip to center.
Optional lip lengths: 1", 1-1/8",
1-3/8", 1-1/2", 1-3/4", 2", 2-1/4", 2-1/2",
2-3/4", 3".
To order with lockset, specify quick code
found on page 11.
To order separately, specify 586L19 x Lip
Length x Finish.

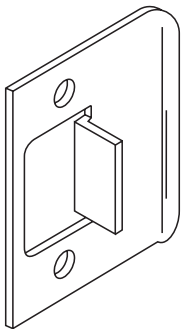

Full Lip Strike

Brass or stainless steel.
2-1/4" x 1-3/4" x 1-1/4" lip to center.
No optional lip lengths.
To order with lockset, specify quick code
found on page 11.
To order separately specify 680L50M020 x
Finish.
Anti-rattle tab.

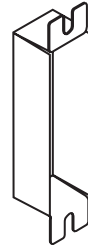

ANSI Wrought Strike Box

To order with lockset, specify quick code
found on page 11. To order separately,
specify 120F768.

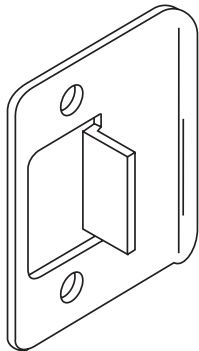

Full Lip Strike – 1/4" Radius Corners

Brass or stainless steel.
Similar in dimension and function to L50
strike (above) but with radius corners for
easy mortising by power tools.
To order with lockset, specify quick code
found on page 11.
To order separately specify 680L51M020 x
Finish.
Anti-rattle tab.

How to Order

CL3800 Series

Ordering Examples

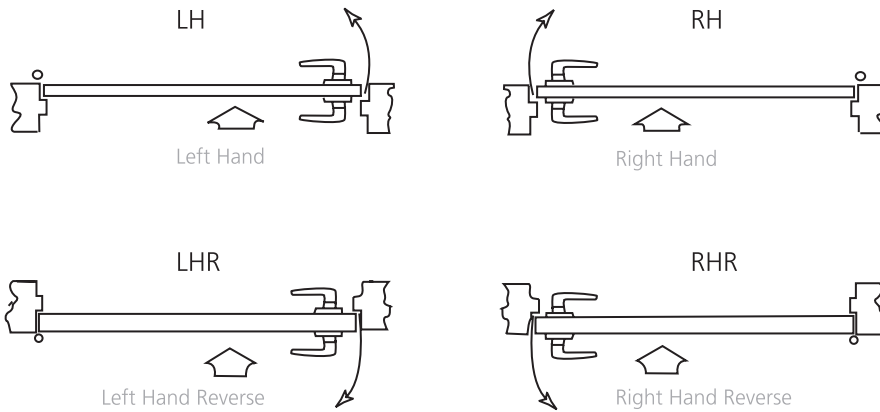

Where to find ordering information and quick codes

Series/Function	Page 4
Trim Designs	Page 5
Finish	Page 10
Cylinders and Keying	Page 10
Strike	Page 11
Door Thickness	Page 11
Backset	Page 11
Miscellaneous Options	Page 11

Stock Order

Quantity	Series/Function	Trim	Finish	Hand
100	CL3855	NZD	626	RHR

Split Trim / Finish Order

Quantity	Series/Function	Trim		Finish		Hand
		Outside	Inside	Outside	Inside	
12	CL3855	NZD	AZD	626	625	RH

Contract / Detailed Order

Quantity	Series/Function	Trim	Finish	Hand	Door Thickness	Backset	Optional Strike	Misc. Options	Optional Cylinder	Keying	Keyset
24	CL3855	NZD	626	RHR	D214	B238	SC114	M17	PHS	CKC2	AA1

Quick Codes

CL3800 Series

Cylinder and Keying

Description	Specify
Conventional 6-pin	(standard)
Conventional 7-pin	7P
Less Cylinder(s)	LC
LFIC	
LFIC 6-pin	C6
LFIC 6-pin Less Core	CL6
LFIC 6-pin Disposable Core	CT6D
LFIC 6-pin with Temporary Construction Core (Red)	CT6R
LFIC 6-pin with Temporary Construction Core (Blue)	CT6B
LFIC 6-pin with Temporary Construction Core (Green)	CT6G
LFIC 7-pin	C7
LFIC 7-pin Less Core	CL7
LFIC 7-pin Disposable Core	CT7D
LFIC 7-pin with Temporary Construction Core (Red)	CT7R
LFIC 7-pin with Temporary Construction Core (Blue)	CT7B
LFIC 7-pin with Temporary Construction Core (Green)	CT7G
SFIC	
SFIC 6-pin	C6S
SFIC 6- or 7-pin Small Format Disposable Core	CTSD
SFIC 6-pin with Temporary Construction Core (Blue)	CT6SB
SFIC 7-pin	C7S
SFIC 7-pin with Temporary Construction Core (Blue)	CT7SB
Security	
Security	HS
Security LFIC	CHS
Access 3®	
Access 3® Patented Fixed Core	AP
Access 3® Security Fixed Core	AS
Access 3® High Security Fixed Core	AHS
Access 3® Patented LFIC	ACP
Access 3® Security LFIC	ACS
Access 3® High Security LFIC	ACHS
Pyramid	
Pyramid Security Fixed Core	PS
Pyramid High Security Fixed Core	PHS
Pyramid Security LFIC	PCS
Pyramid High Security LFIC	PCHS
Pyramid LFIC Less Core	CLP
Pyramid with Temporary Construction Core	CTP
Pyramid Disposable Core	CTPD
Keying and Keys	
0-bitted with 2 blank keys	(standard)
Keyed Random	KR
Construction Master Keyed	CMK
2 keys per lock	(standard)
More than 2 keys	KY# (e.g., KY6)

Cylinder and Keying (cont.)

Description	Specify
Visual key control (VKC)	
No biting or keyset stamping on keys	VKC0
Keys only	VKC1
Cylinders and keys (not for AS, AHS, ACS, ACHS, HS, CHS, PHS or PCHS)	VKC2
Cylinders only (not for AS, AHS, ACS, ACHS, HS, CHS, PHS or PCHS)	VKC3
Concealed key control (CKC)	
CKC cylinders with VKC keys	CKC2
CKC cylinders only (not for AS, AHS, ACS, ACHS, PHS, PCHS)	CKC3
Schlage® C keyway cylinder (0-Bitted or KR)	C
SARGENT® LA keyway cylinder (0-Bitted)	LA

Finishes

Description	Specify	
ANSI/BHMA 605 (US3)	Bright Brass, Clear Coated	605
ANSI/BHMA 606 (US4)	Satin Brass, Clear Coated	606
ANSI/BHMA 611 (US9)	Bright Bronze, Clear Coated	611
ANSI/BHMA 612 (US10)	Satin Bronze, Clear Coated	612
ANSI/BHMA 613 (US10B)	Dark Oxidized Satin Bronze, Oil Rubbed	613
613E	Dark Oxidized Satin Bronze, Equivalent	613E
613L	Dark Oxidized Satin Bronze, Clear Coated	613L
ANSI/BHMA 618 (US14)	Bright Nickel Plated, Clear Coated	618
ANSI/BHMA 619 (US15)	Satin Nickel Plated, Clear Coated	619
619C	Satin Nickel Plated with MicroShield®	619C
ANSI/BHMA 625 (US26)	Bright Chrome Plated	625
ANSI/BHMA 626 (US26D)	Satin Chrome Plated	626
626C	Satin Chrome Plated with MicroShield®	626C
ANSI/BHMA 722	Black Oxidized Bronze, oil rubbed	722
BSP	Black Suede Powder Coat	BSP
WSP	White Suede Powder Coat	WSP

Zinc levers are plated to match ANSI/BHMA finish.

Lock/Cylinder Finish

Lock	Cylinder/Core*
605,606,611,612,613,613E,613L,722	606
618,619,625,626,WSP	626
BSP	BSP

*Finish when cylinder provided with lock

Quick Codes

CL3800 Series

Strikes

ANSI Lip to Center	ANSI Curved Lip Specify	Curved Lip Box Specify	Full Lip Specify	Full Lip Radius Corner Specify
1" (25mm)	SA100	SC100	N/A	N/A
1-1/8" (29mm)	SA118	SC118	N/A	N/A
1-1/4" (32mm)	SA114 (standard)	SC114	SF114	SFR114
1-3/8" (35mm)	SA138	SC138	N/A	N/A
1-1/2" (38mm)	SA112	SC112	N/A	N/A
1-3/4" (44mm)	SA134	SC134	N/A	N/A
2" (51mm)	SA200	SC200	N/A	N/A
2-1/4" (57mm)	SA214	SC214	N/A	N/A
2-1/2" (64mm)	SA212	SC212	N/A	N/A
2-3/4" (70mm)	SA234	SC234	N/A	N/A
3" (76mm)	SA300	SC300	N/A	N/A

Door Thickness

Door Thickness	Specify
1-3/8" (35mm) - 1-7/8" (48mm)	(standard)
2" (51mm) - 2-1/4" (57mm)	D214

Backset

Description	Specify
2-3/8" (60mm)	B238
2-3/4" (70mm)	(standard)
3-3/4" (95mm)	B334
5" (127mm)	B500

Miscellaneous Options

Description	Specify
Spanner head screws	M02
Torx® head screws	M04
Less cylinder, with tailpiece for Schlage® fixed core cylinder (all designs)	M06
Lever to accept SFIC 6 or 7-pin interchangeable core (all designs)	M08
Lever to accept SARGENT® cylinder (NZD & PZD designs only)	M09
Lever to accept Schlage® Interchangeable core (NZD & PZD design only)	M69
Rounded corners on latch front	M13
1" latch front, square corners (standard for 2-3/8" backset)	M14
1" latch front, rounded corners	M15
ANSI wrought strike box	M17
Knurling outside and inside	M20*
Knurling outside only	M21*
Knurling inside only	M22*
Abrasive coat outside and inside	M23
Abrasive coat inside only	M24
Abrasive coat outside only	M25
1-1/8" front, square corners (standard for 2-3/4", 3-3/4" and 5" backsets)	M32

*All levers provided in a powder coat finish will be supplied with an abrasive coating

How to Specify

CL3800 Series

Suggested Specification

Lockset chassis shall be constructed of heavy gauge steel and cast components, plated to protect against rust and corrosion. Locksets shall be adjustable for 1-3/8" (35mm) and 1-7/8" (48mm) or 2" (51mm) and 2-1/4" (57mm) door thickness.

Locksets shall be non-handed, and shall install easily without the need for specialized installation tools. Locksets shall have separate anti-rotation thru-bolts in the 6 o'clock and 12 o'clock position outside the 2-1/8" face bore, and shall have no exposed mounting screws.

Locksets shall have solid one-piece, cast levers without plastic inserts, and shall be a minimum of 4" (102mm) in length. Levers shall operate independently, and shall have inside and outside lever return springs. Outside levers on the keyed locksets shall be removable only when the designated key is in the cylinder.

Vandal-resistant levers shall be offered as a standard feature in all locking functions and shall be free-wheeling in the locked condition. Locksets that are rigid in the locked condition, or must require resetting (breakaway) are not acceptable.

All locksets shall carry a five-year mechanical warranty.

All locksets shall comply with the following certifications:

- UL-cUL 3-Hour Fire Rating
- ANSI/BHMA A156.2 Series 4000, Grade 2
- ANSI/BHMA A117.1 Accessibility Code
- ANSI/BHMA A156.115 & A156.115W Preparations
- Windstorm/Hurricane (refer to local codes)

All locksets shall be CL3800 Series Grade 2 Key-in-Lever Cylindrical Locksets as manufactured by Corbin Russwin Architectural Hardware.

Notes

CL3800 Series

The ASSA ABLOY Group is the global leader in access solutions. Every day, we help billions of people experience a more open world.

ASSA ABLOY Opening Solutions leads the development within door openings and products for access solutions in homes, businesses and institutions. Our offering includes doors, frames, door and window hardware, mechanical and smart locks. access control and service.



For additional information, contact your
ASSA ABLOY Door Security Solutions
sales consultant or visit www.corbinrusswin.com.

In U.S.

Corbin Russwin
Architectural Hardware
225 Episcopal Road
Berlin, CT 06037
Phone: 800-543-3658
Fax: 800-447-6714
www.corbinrusswin.com

In Canada

ASSA ABLOY Door
Security Solutions Canada
160 Four Valley Drive
Vaughan, Ontario
Canada L4K 4T9
Phone: 800-461-3007
Fax: 800-461-8989
www.assaabloydss.ca

MicroShield®

ASSA ABLOY Group companies offer MicroShield®, an anti-microbial coating for door hardware. MicroShield uses proven silver ion-based technology from Agion®, a leading provider of antimicrobial solutions, to stem the spread of bacteria and other microbes.

MicroShield® is a registered trademark of ASSA ABLOY Access and Egress Hardware Group, Inc.



The Agion antimicrobial is not intended as a substitute for good hygiene. Coated products must still be cleaned to ensure the surfaces will be free of destructive microbes. ASSA ABLOY makes no representations or warranties, express or implied, as to the efficacy of the Agion antimicrobial. A copy of the Agion warranty is available upon request. Agion is a registered trademark of Agion Technologies, Inc., Wakefield, MA, USA.