



CAL-ROYAL
P R O D U C T S , I N C . U S A .



SC SERIES

**EXTRA HEAVY DUTY MORTISE LOCKS
WITH *CLUTCH*
GRADE 1**

RETROFITS SCHLAGE L9000 SERIES MORTISE LOCKS



Architectural Hardware

SC SERIES

Grade 1 Extra Heavy Duty Mortise Locks
with CLUTCH free-wheeling
ANSI BHMA A156.13 - 2017



MEETS
The Buy American Act

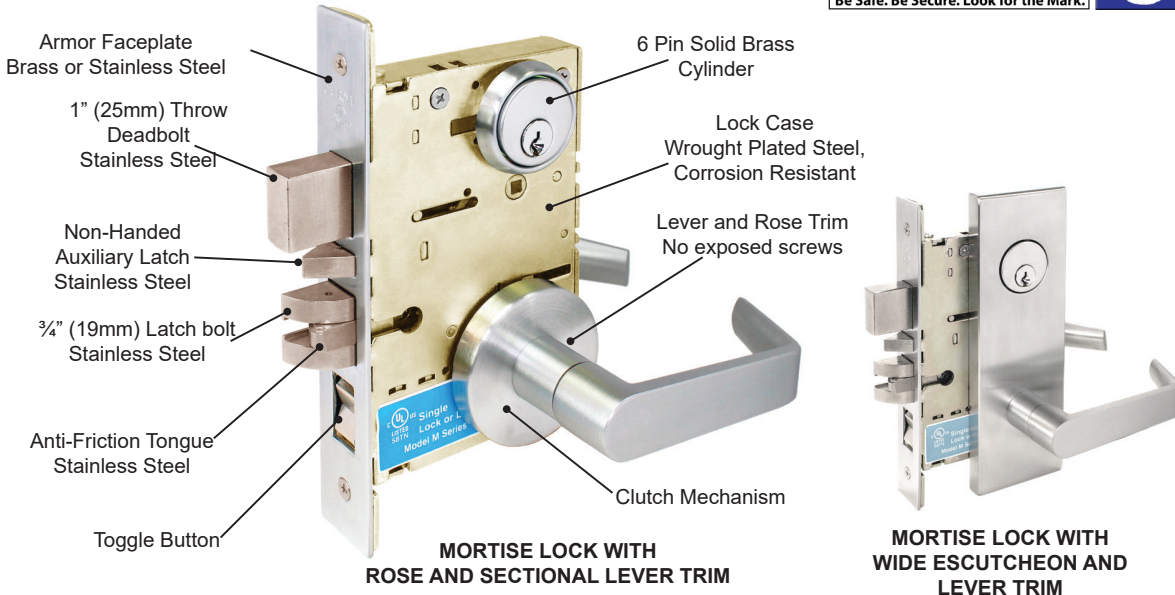

MORTISE LOCK WITH ROSE AND SECTIONAL LEVER TRIM

MORTISE LOCK WITH WIDE ESCUTCHEON AND LEVER TRIM

- Can retrofit Schlage L9000 Series mortise lock without drilling any additional holes on the door for sectional and escutcheon trims
- Fully reversible design
- No exposed mounting screws on outside and inside trims
- Outside lever has a Clutch (Free-Wheeling design). The lever rotates when the lever is locked preventing excessive force from being applied to the horizontal lever. The design decreases the chance of the lever being broken or damaged
- Lock body conforms to all dimensional and operational performances of ANSI A156.13, Grade 1, exceeds 1,000,000 cycles

SPECIFICATIONS

FOR DOORS

1 3/4" (44.5mm) thick standard. For doors over 1 3/4" (44.5mm), specify door thickness

LOCK HAND

Lock bodies are easily field reversible, no need to specify hand when ordering

BACKSET & STRIKE

2 3/4" (70mm) only backset. Brass or stainless steel strike; ANSI Standard A115.1; curve lip with dust box

LOCK CASE

Heavy Duty wrought steel, zinc dichromate plated

CENTER TO CENTER

Center of lever to center of cylinder is 3 7/8" (98mm)

ARMOR FACEPLATE

Brass or stainless steel; 8" x 1 7/32" (203mm x 31.3mm); ANSI Standard A115.1

DEADBOLT

1" (25.4mm) throw; hardened stainless steel

LATCH BOLT

3/4" (19mm) throw; one-piece stainless steel with anti-friction reversible tongue

CYLINDER & KEYWAYS

6-pin solid brass "C" keyway standard. Optional: Schlage E, Schlage C-K, Russwin D1-2-3-4, Corbin 59 / 60, Corbin-Russwin L4, Sargent LA-LB-LC, Falcon / Weiser E, Arrow A, Yale 8, Yale GA and Kwikset. Can also accept Medeco, Assa, Kaba and Cal-Royal HSK High Security Cylinders.

INTERCHANGEABLE CORE (IC)

Interchangeable Core locks will accept compatible 6 or 7 pin cores with BEST, FALCON and ARROW (SFIC). Also available with SCHLAGE, CORBIN / RUSSWIN D-1 thru 4, SARGENT LA, and YALE GA Large Format Cylinders.

TOGGLE BUTTON

High rust-resistant chrome plated zinc alloy

MASTER KEYING

Can be master-keyed or grand master-keyed, construction keying available

FINISHES: US3, 4, 10, 10B, 19, 26, 26D, 32, 32D

AUXILIARY LATCH: Stainless Steel, non-handed

CERTIFICATIONS

- ANSI / BHMA** Meets ANSI / BHMA A156.13, Series 1000, Operational & Security Grade 1 Standards
- UL / cUL** UL and UL Listed to Canadian safety standard for A label (3-hour fire door); stamped letter F and UL symbol on armor faceplate
- POSITIVE PRESSURE** Meets positive pressure requirements UL 10C and UBC 7-2 (1997)
- ADA** Meets ADA requirements, specifically designed for Barrier Free Application



DIMENSIONS

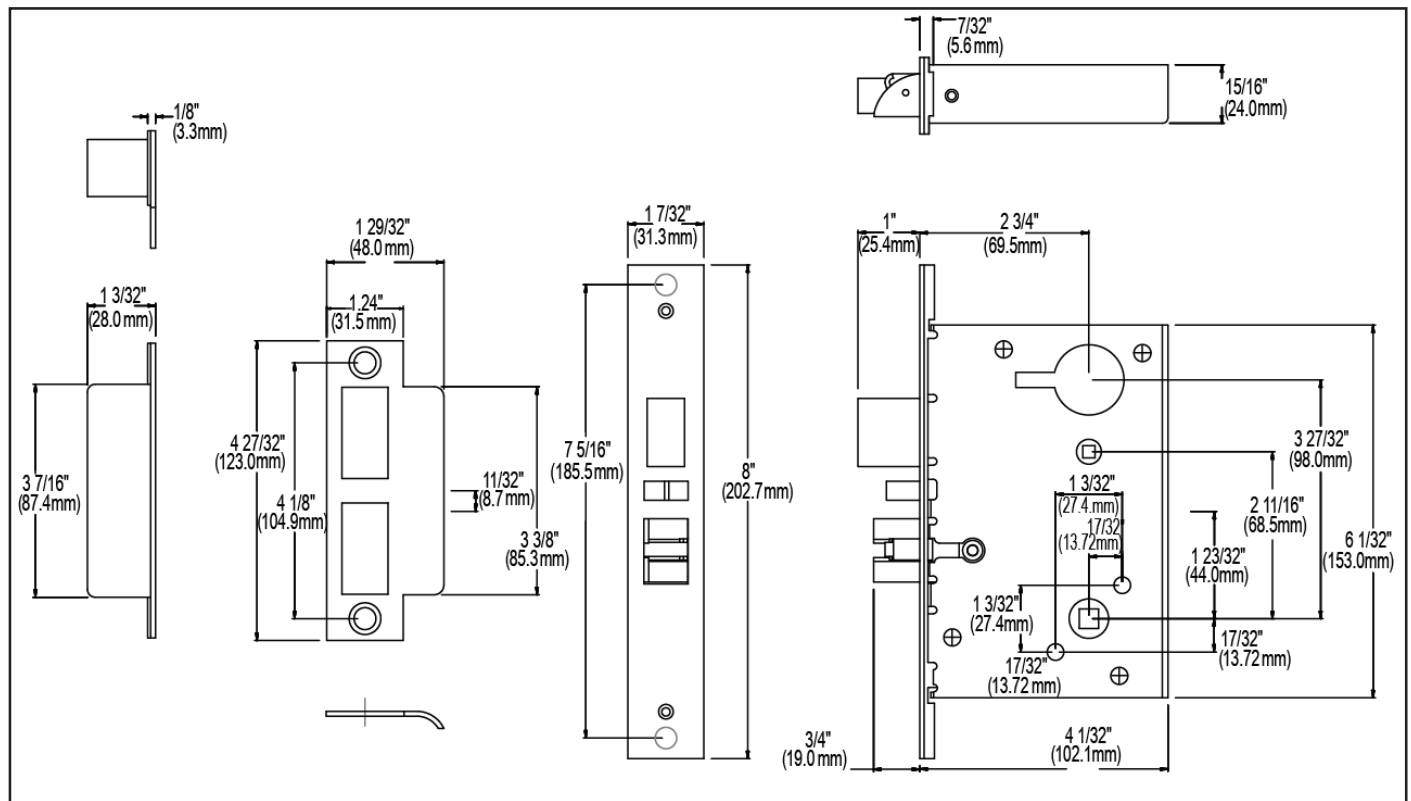

SC SERIES

TRIMS & FINISHES

SECTIONAL

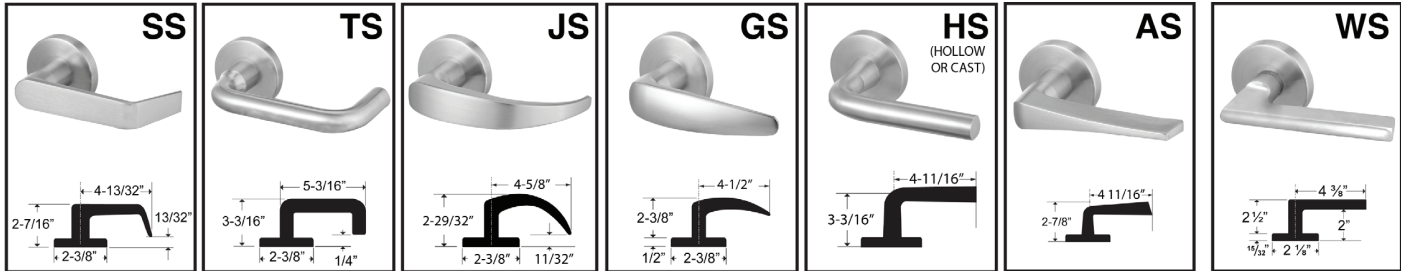

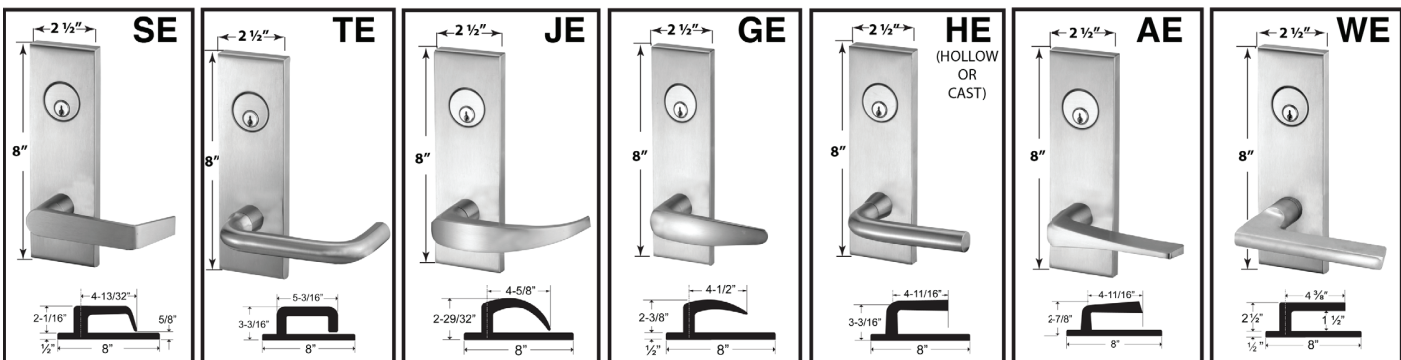

WIDE ESCUTCHEON

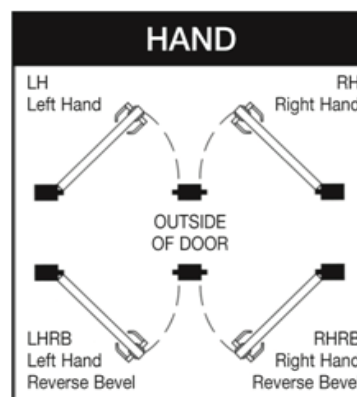

FINISHES		
Symbol	BHMA	Description
US3	605	Polished Brass
US4	606	Satin Brass
US10B	613	Oil Rubbed Bronze
US19	622	Flat Black Coated
US26	625	Polished Chrome
US26D	626	Satin Chrome
US10	612	Satin Bronze
US32D	630	Stainless Steel

ITEM	MATERIAL
Rose	Brass / Stainless Steel
Levers	Brass / Zinc / Stainless Steel
Escutcheons	Brass / Zinc / Stainless Steel



 Available with Best, Falcon and Arrow (Small Format IC), Schlage, Corbin / Russwin, Sargent, and Yale Interchangeable core.

-  • ICSC - Schlage LFIC
-  • ICCR - Corbin / Russwin LFIC
-  • ICSR - Sargent LFIC
-  • ICYA - Yale LFIC

SC SERIES

Kits and Accessories

► ADA Thumbturn

Optional Disability Turn (ADA) on applicable mortise locks.
Prefix "ADA" before Mortise lock PART#.

Order kit: SCSADA - ADA Thumbturn for Sectional
SCEADA - ADA Thumbturn for Escutcheon



► for 2" up to 2 1/4" thick doors

Order kit: SCSKIT200 – for sectional trim
SCEKIT214 – for escutcheon trim

HOW TO ORDER (SC SERIES)

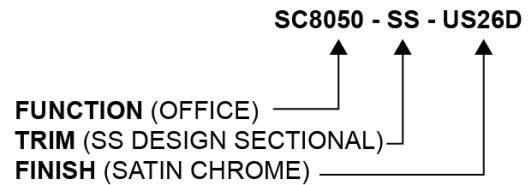

**ALL PRODUCTS ARE SHIPPED NON-HANDED.
EASILY FIELD REVERSIBLE.**

Indicator Mortise Locks

Privacy with Key Outside and "OCCUPIED" Indicator

SC8495

- Deadbolt thrown or retracted by key outside or inside thumbturn
- Knob / lever retracts latch bolt from either side
- Throwing deadbolt locks outside knob / lever and displays "OCCUPIED" plate
- Rotating inside knob / lever simultaneously retracts both deadbolt and latch bolt and unlocks outside knob / lever
- Inside lever is always free for immediate egress

SC8495
SC8486



Faculty Restroom with Key Outside and "OCCUPIED" Indicator

SC8486

- Latch bolt retracted by key outside or by knob / lever inside. Outside knob / lever always fixed
- Deadbolt thrown or retracted by inside thumbturn
- When deadbolt is thrown, "OCCUPIED" plate is displayed and all keys become inoperative except emergency keys
- Turning inside knob / lever simultaneously retracts both deadbolt and latch bolt
- Auxiliary latch deadlocks latch bolt when door is locked
- Inside lever is always free for immediate egress

SC8445



Privacy with Deadbolt, Coin Turn Outside and "OCCUPIED" Indicator

SC8445

- Deadbolt thrown or retracted by inside thumbturn or outside coin turn
- Rotating outside coin turn retracts deadbolt and unlocks outside knob / lever
- Latch bolt retracted by knob / lever from either side
- Throwing deadbolt locks outside knob / lever and displays "OCCUPIED" plate
- Rotating inside knob / lever simultaneously retracts deadbolt and latch bolt and unlocks outside knob / lever
- Inside lever is always free for immediate egress

► TACTILE

Available on request. Use PART# "TAC".

► LEAD LINING

Available on request. Use PART# "LEAD".

► ANTI MICROBIAL COATING

Available on request on US26D and US32D finishes. Longer factory lead time usually applies. Specify "ANTB" when ordering.

► HOW TO CHANGE HANDING

If the handing of the latch bolt does not match the door handing, remove locking screw and pull latch bolt out from lock case, then turn 180°, making the bevel of the latch bolt face the opposite hand. Replace the latch bolt and fasten the locking screw.

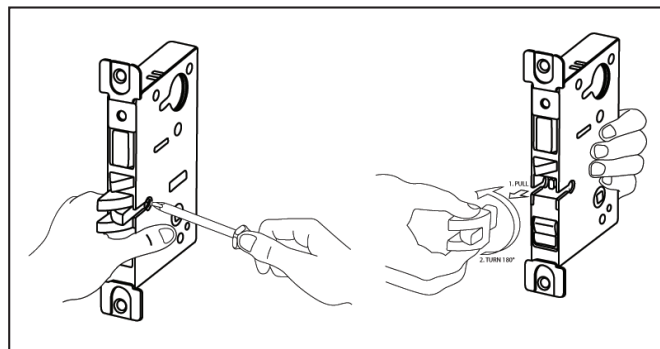

SC400 Series

ELECTRIFIED MORTISE LOCKS

Available with or without deadbolt

FEATURES:

- UL and CUL Listings
- Continuous duty solenoids for cooler operation during “continuously on” applications
- Allows for an AC or DC power source through an appropriate power supply. No polarity.
- Low current draw
- Numerous switch options
- 3 year “No Hassle” warranty

OPTIONS:

- Voltage requirement - 12V AC / DC or 24V AC / DC
- Amperage - 600mA ±10% @ 12V or 300mA ±10% @ 24V
- Solenoid coil resistance - 12V = 20 Ω ±5% or 24V = 80 Ω ±5%
- Power consumption - 7.2 watts ±10%
- Function – available Fail Safe, “Electrically Locked” (EL) or Fail Secure, “Electrically Unlocked” (EU)

RETROFITS SCHLAGE L9000
(direct chassis replacement)

HOW TO ORDER ELECTRIFIED SC400 SERIES

- Use **SC Models** if ordered as an **ELECTRIFIED LOCK CASE ONLY**.
- Use **ESC Models** if ordered as a complete lock with **ADD-ON list price**.
Must Specify: SC Series item # and Electrification Option
(refer to table below) separately.
For Example: SC8080SS US26D with ESC400 (EL 12V) option,
Order: SC8080SS US26D and ESC400 as two line items.

- ▶ **RX** – Request to Exit Switch (Monitors the inside handle)
- ▶ **LBM** – Latch Bolt Monitoring Switch (Monitors the position of latch bolt)
- ▶ **DPS** – Door Position Switch
(*Sold Separately. Not installed on the lock.)

**REFER TO PRICELIST
FOR STOCK FINISHES AND FUNCTIONS**

ELECTRIFICATION OPTIONS (WITHOUT DEADBOLT)							ELECTRIFIED LOCK CASE ONLY
MODEL #	EL	EU	12	24	RX	LBM	MODEL #
ESC400	✓		✓				SC400
ESC400-RX	✓		✓		✓		SC400-RX
ESC400-LBM	✓		✓			✓	SC400-LBM
ESC400-RXLBM	✓		✓		✓	✓	SC400-RXLBM
ESC404	✓			✓			SC404
ESC404-RX	✓			✓	✓		SC404-RX
ESC404-LBM	✓			✓		✓	SC404-LBM
ESC404-RXLBM	✓			✓	✓	✓	SC404-RXLBM
ESC408		✓	✓				SC408
ESC408-RX		✓	✓		✓		SC408-RX
ESC408-LBM		✓	✓			✓	SC408-LBM
ESC408-RXLBM		✓	✓		✓	✓	SC408-RXLBM
ESC412		✓		✓			SC412
ESC412-RX		✓		✓	✓		SC412-RX
ESC412-LBM		✓		✓		✓	SC412-LBM
ESC412-RXLBM		✓		✓	✓	✓	SC412-RXLBM

ELECTRIFICATION OPTIONS (WITH DEADBOLT)							ELECTRIFIED LOCK CASE ONLY
MODEL #	EL	EU	12	24	RX	LBM	MODEL #
ESC416	✓		✓				SC416
ESC416-RX	✓		✓		✓		SC416-RX
ESC416-LBM	✓		✓			✓	SC416-LBM
ESC416-RXLBM	✓		✓		✓	✓	SC416-RXLBM
ESC420	✓			✓			SC420
ESC420-RX	✓			✓	✓		SC420-RX
ESC420-LBM	✓			✓		✓	SC420-LBM
ESC420-RXLBM	✓			✓	✓	✓	SC420-RXLBM
ESC424		✓	✓				SC424
ESC424-RX		✓	✓		✓		SC424-RX
ESC424-LBM		✓	✓			✓	SC424-LBM
ESC424-RXLBM		✓	✓		✓	✓	SC424-RXLBM
ESC428		✓		✓			SC428
ESC428-RX		✓		✓	✓		SC428-RX
ESC428-LBM		✓		✓		✓	SC428-LBM
ESC428-RXLBM		✓		✓	✓	✓	SC428-RXLBM

▶ *Electrified Mortise Lock Case can be purchased separately. Refer to table above for options*

SC SERIES

Grade 1 Heavy Duty Hospital Latch HL Trims Push-Pull Trim with Mortise Lock



FEATURES

- The push-pull trim can be mounted in vertical (up or down) and horizontal applications in the field
- Through-bolted design for trims with lockcase for more stability
- Handing is easily field reversible
- Fits 1 3/4" (44mm) thick standard RHR or LHR hollow metal doors & wood doors, over 1 3/4" (44mm) is also available (specify door thickness when ordering)
- Push-Pull trim is non-handed, easy installation
- Mortise lock functions available (recommended): F01, F04, F05, F09, F11, F13, F14, F19 F20, F22, F30
- Handles are cast stainless steel, corrosion protected
- Patented in USA and UL Listed
- Available in BHMA finishes

SC SERIES

GRADE 1 • HEAVY DUTY • ANSI A156.13 - 2017
LIGATURE RESISTANT (LG) MORTISE LOCK TRIM



ESCUTCHEON LEVER (LGE)



ESCUTCHEON KNOB (LGX)



SECTIONAL LEVER (LGS)



SECTIONAL KNOB (LGK)

FEATURES

- ANSI A156.13-2017 Grade 1 Mortise locks
- Outside lever clutch free-wheeling design.
- The lever rotates when the lever is locked preventing excessive force from being applied to the horizontal lever. This design decreases the chance of the lever being broken or damaged
- Ligature Resistant lever design helps to prevent intentional or accidental hanging
- Anti-vandal cylinder guard is standard, deters forcible removal of cylinder with any type of wrench or hammer
- Different functions available to satisfy individual security and safety requirements
- Tamper resistant concealed mounting set screws
- Non-handed, fully field reversible
- Heavy duty escutcheon and sectional trim available
- No exposed mounting screws
- Can retrofit Schlage L9000 Series mortise lock bodies
- Trim Suffixes: **S**-Lever Sectional **E**-Lever Escutcheon
K-Knob Sectional **X**-Knob Escutcheon

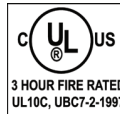

MEETS
The Buy American Act

LIFETIME
WARRANTY



BHMA
CERTIFIED
Be Safe. Be Secure. Look for the Mark.

CERTIFICATIONS

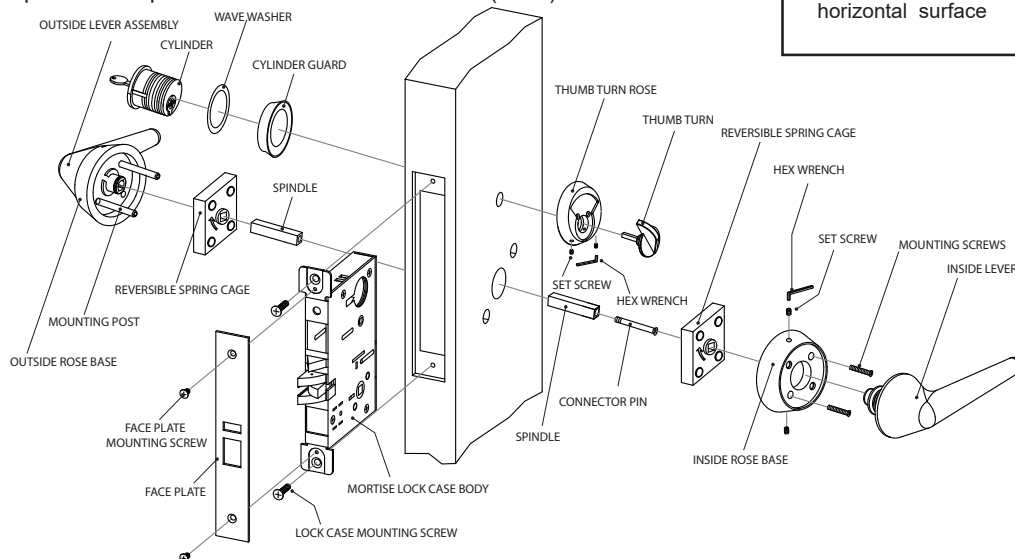
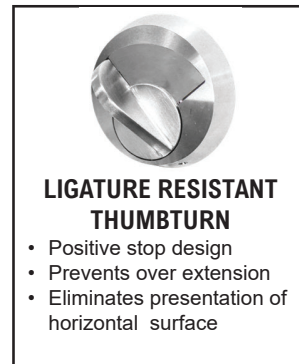
- Meets ANSI / BHMA A156.13 Series 1000 Grade 1 Requirements
- UL and cUL listed to Canadian safety standard for A label (3-hour fire door); stamped letter "F" and UL symbol on armor faceplate
- Meets positive pressure requirements UL 10C and UBC 7-2 (1997)



HEAVY DUTY ANSI A156.36 GRADE 1 SMALL LOCK CASE	SC SERIES MORTISE DEADBOLTS	HEAVY DUTY ANSI A156.13 GRADE 1 FULL MORTISE
--	--	---

Lock Case:
3 15/16" x 3 5/8" x 15/16"
(100 mm x 92 mm x 25 mm)

Faceplate:
1 1/4" x 5 5/8" x 1 7/32"
(32 mm x 142 mm x 6 mm)

Strike:
1 1/8" x 3 1/2" (29 mm x 89 mm)

Any door in commercial or institutional buildings where the best auxiliary Mortise deadbolt locks are required

- **Backset:** 2 3/4" (70 mm)
- **Door Range:** 1 3/4" (44.5 mm), available to 2 1/4" (57 mm)
- **Deadbolt:** 1" (25 mm) throw, stainless steel, can withstand cutting or sawing
- **Cylinder:** 1 1/4" Mortise cylinder Schlage "C" (standard)
- **Heavy Gauge Steel Lock Case**
- **Brass Deadbolt with Hardened Steel, 1" Throw**
- **Satin Chrome Finish**
- **ANSI A156.13**
- **Exceeds 1,000,000 cycles**

Mortise Cylinder

- Cylinder length is 1 1/8" (under shoulder including cam)
- With Schlage cam (L583-2540)



SC SERIES







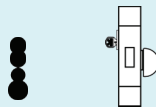
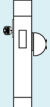
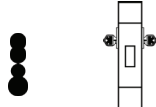

Lock Case:
4" x 6 1/32" x 1 7/32"
(102 mm x 153 mm x 31.3 mm)

Faceplate:
1 7/32" x 8" x 1/8"
(31.3 mm x 203 mm x 3.175 mm)

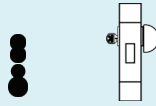
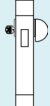
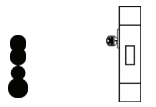
Strike:
1 7/8" x 4 27/32" (48 mm x 123 mm)

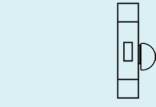
**LIFETIME
WARRANTY**

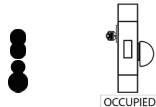
BHMA
CERTIFIED
Be Safe. Be Secure. Look for the Mark.

MODEL #	FUNCTIONS	MODEL #
SM140 	Cylinder and Thumbturn Deadbolt thrown or retracted by key outside or thumbturn inside	SC8460 ANSI F17 
SM143 	Double Cylinder Deadbolt operated by key on either side	SC8462 ANSI F16 
SM141 	Classroom Lock Deadbolt thrown or retracted by key from outside. Inside thumbturn cylinder retracts deadbolt but cannot project it. Specify handing.	SC8463 ANSI F29 
SM142 	Cylinder Lock Deadbolt thrown or retracted by key from outside only. No trim on opposite side.	SC8464 ANSI F18 
SM145 	Door Bolt Deadbolt thrown or retracted by thumbturn from one side. No trim on opposite side	SC8461 
SM146 	Deadbolt With "Occupied" Indicator Deadbolt thrown or retracted by key outside or thumbturn inside. When deadbolt is thrown "OCCUPIED" plate is displayed	SC8496 
<p>PACKAGING INCLUDES</p> <ul style="list-style-type: none"> • UL listed single point latch • Standard "C", 6 pin cylinder • Non-handed strike 		
<p>OPTIONAL INTERCHANGEABLE CORE</p> <ul style="list-style-type: none"> • For Best, Falcon and Arrow Interchangeable Core prefix "IC" before Part#. (Mortise housing Part# ICH961387) • For Schlage Large Format Interchangeable Core prefix "ICSC" before Part#. • For Corbin / Russwin Large Format Interchangeable Core prefix "ICCR" before Part#. • For Sargent Large Format Interchangeable Core prefix "ICSA" before Part#. • For Yale Large Format Interchangeable Core prefix "ICYA" before Part#. (Mortise housing Part# 7000ICMC) 		

ADDITIONAL KEYWAYS
6 pin solid brass "C" keyway standard. Optional: Schlage E, Schlage C-K, Russwin D1-2-3-4, Corbin 59 / 60, Sargent LA-LB-LC, Falcon / Weiser E, Arrow A, Yale 8, Yale GA and Kwikset. Can also accept Medeco, Assa, Kaba and Cal-Royal HSK High Security Cylinders.

OUTSIDE	INSIDE	SERIES/FUNCTION	TYPE	ANSI	FUNCTION DESCRIPTION
		SC8050 SC8050HL SC8050LG	Office / Entrance	F04	Latch bolt retracted by key outside and inside lever when outside lever is locked. Outside lever retracts latch bolt unless outside lever is locked by operating toggle button. Outside lever is locked and unlocked by toggle button. Key outside locks outside lever only. When latch bolt is retracted by inside lever, outside lever remains locked. Auxiliary latch deadlocks latch bolt when door is closed. Inside lever is always free for immediate exit.
		SC8056	Office with Automatic Unlocking	---	Latch bolt retracted by knob / lever from either side unless outside is made inoperative by key outside or by rotating inside thumbturn. Outside knob / lever unlocked by key outside or thumbturn. Rotating inside knob / lever simultaneously retracts latch bolt and unlocks outside knob / lever. Auxiliary latch deadlocks bolt when door is locked. Inside knob / lever is always free of immediate egress.
		SC8070 SC8070HL SC8070LG	Classroom	F05	Outside key locks and unlocks outside lever. Outside lever retracts latch bolt unless outside lever is locked by key. When outside lever is locked, unlocked from outside by key or by inside lever. Inside lever is always free for immediate exit. Auxiliary latch deadlocks latch bolt when door is closed.
		SC8071 SC8071LG	Classroom Security Lock	F32	Latch bolt retracted by knob / lever from either side unless outside is locked by key from either side. When outside lever is locked, latch bolt is retracted by key outside or lever inside. Turning key from either side locks and unlocks outside lever. Auxiliary latch deadlocks latch bolt when door is locked. Inside knob / lever is always free for immediate egress.
		SC8076	Classroom Hold-Back Lock	F06	Latch bolt retracted by knob / lever from either side unless outside is locked by key. When locked, latch bolt retracted by key outside or knob / lever inside. Auxiliary latch deadlocks latch bolt when door is locked. Depress inside knob / lever and turn key 360° for hold-back feature.
		SC8077	Classroom Security Hold-Back Lock	---	Latch bolt retracted by knob / lever from either side unless outside is locked by key from either side. When locked, latch bolt retracted by key outside or knob / lever inside. Auxiliary latch deadlocks latch bolt when door is locked. Depress inside knob / lever and turn key 360° for hold-back feature. Inside knob / lever is always free for immediate egress.
		SC8457 SC8457LG	Classroom Security Lock w/ Deadbolt	F33	Latch bolt retracted by outside lever from either side unless outside lever is locked by key from inside or outside. Deadbolt projected or retracted by key outside. Operating inside lever retracts both deadbolt and latch bolt simultaneously and unlock outside lever. Inside knob / lever is always free for immediate egress.
		SC8458 SC8458LG	Classroom Security Lock w/ Deadbolt and Auxiliary Latch	F34	Latch bolt retracted by lever from either side unless outside lever is locked from inside or outside by key. Deadbolt projected or retracted by key outside. Operating inside lever retracts both bolts and unlocks outside lever. Auxiliary latch deadlocks latch bolt when door is closed or latch bolt deadlocks when deadbolt is projected. Inside lever is always free for immediate egress.
		SC8463	Classroom Lock	F29	Deadbolt thrown or retracted by key from outside. Inside thumbturn cylinder retracts deadbolt but cannot project it.
		SC8080 SC8080LG	Storeroom	F07	Latch bolt operated by key from outside or rotating inside lever, outside lever is always inoperative. Auxiliary latch deadlocks latch bolt when door is closed. Inside lever is always free for immediate egress.
		SC8480	Storeroom Lock with Deadbolt	---	Latch bolt retracted by key outside or by lever or knob inside. Outside knob / lever is always fixed. Deadbolt thrown or retracted by key outside or thumbturn inside. Turning inside knob / lever simultaneously retracts both deadbolt and latch bolt. Auxiliary latch deadlocks latch bolt when door is closed. Inside knob / lever is always free for immediate egress.

OUTSIDE	INSIDE	SERIES/FUNCTION	TYPE	ANSI	FUNCTION DESCRIPTION
		SC8453 SC8453HL SC8453LG	Entrance	F20	Latch bolt retracted by lever from either side unless outside lever is locked by operating toggle button. Deadbolt projected by key from outside or by thumbturn from inside. Both deadbolt and latch bolt are retracted by inside lever simultaneously. Latch bolt is deadlocked when outside lever is locked or when deadbolt is projected. Outside lever is unlocked by toggle button if deadbolt is retracted. Inside lever is always free for immediate egress.
		SC8456 SC8456HL SC8456LG	Corridor	F13	Latch bolt retracted by knob / lever from either side. Deadbolt thrown or retracted by key outside or inside thumbturn. Throwing deadbolt locks outside knob / lever. Turning inside knob / lever simultaneously retracts deadbolt and latch bolt and unlocks outside knob / lever. Inside knob / lever is always free for immediate egress.
		SC8473 SC8473HL SC8473LG	Dormitory / Bedroom	F21	Latch bolt retracted by knob or lever from either side. Deadbolt extended or retracted by key outside or thumbturn inside. Latch bolt and deadbolt are independent of each other.
		SC8460	Cylinder x Thumbturn Lock	F17	Deadbolt thrown or retracted by key outside or thumbturn inside.
		SC8060 SC8060HL SC8060LG	Apartment Entrance / Vestibule	F09	Latch bolt operated by lever from either side except when outside lever is locked by inside key. Outside key or inside lever will retract latch when locked. Key inside locks and unlocks outside lever. Auxiliary latch deadlocks latch bolt when door is closed. Inside lever is always free for immediate egress.
		SC8466 SC8466HL SC8466LG	Store Door Lock (Asylum-4)	F14	Latch bolt operated by lever from either side. Deadbolt projected or retracted by key on either side. Latch bolt and deadbolt are independent of each other.
		SC8462	Double Cylinder Lock	F16	Deadbolt operated by key from either side.
		SC8464	Cylinder Lock	F18	Deadbolt thrown or retracted by key from outside only. No trim on opposite side.
		SC8082 SC8082HL SC8082LG	Asylum / Institution Lock	F30	Latch bolt retracted by key from either side. Knob / lever on both sides always inoperative. Auxiliary latch deadlocks latch bolt when door is closed.
		SC8465	Closet / Storeroom with Deadbolt	F65	Latch bolt retracted by knob or lever from either side. Deadbolt extended or retracted by key outside.
		SC8044	Privacy w/ Coin Turn Outside	F22	Latch bolt retracted by knob / lever from either side unless outside is locked by inside thumbturn or outside coin turn. Operating inside knob / lever, closing door, rotating inside thumbturn or rotating outside coin turn unlocks outside knob / lever. Inside knob / lever is always free for immediate exit.

OUTSIDE	INSIDE	SERIES/FUNCTION	TYPE	ANSI	FUNCTION DESCRIPTION
		SC8440 SC8440HL SC8440LG	Privacy with Deadbolt	F19	Latch bolt retracted by knob / lever from either side. Deadbolt thrown or retracted by inside thumbturn. Throwing deadbolt locks outside knob / lever. Rotating inside knob / lever simultaneously retracts deadbolt and latch bolt, and unlocks outside knob / lever. To unlock from outside, remove emergency button, insert emergency thumbturn in access hole and rotate. Inside knob / lever is always free for immediate egress.
		SC8040 SC8049HL SC8049LG	Privacy Bedroom / Bath	F22	Latch bolt retracted by knob / lever from either side unless outside is locked by inside thumbturn. Operating inside knob / lever, closing door, or operating outside emergency release unlocks outside knob / lever. Inside knob / lever is always free for immediate exit.
		SC8444	Privacy w/ Deadbolt and Coin Turn Outside	F19A	Latch bolt retracted by knob / lever from either side. Deadbolt thrown or retracted by inside thumbturn or outside coin turn. Throwing deadbolt locks outside knob / lever. Rotating inside knob / lever simultaneously retracts deadbolt and latch bolt, and unlocks outside knob / lever. Rotating outside coin turn retracts deadbolt and unlocks outside knob / lever. Inside knob / lever is always free for immediate egress.
		SC8445	Privacy w/ Deadbolt, Coin Turn Outside and "OCCUPIED" Indicator	F19B	Latch bolt retracted by knob / lever from either side. Deadbolt thrown or retracted by inside thumbturn or outside coin turn. Throwing deadbolt locks outside knob / lever and displays "OCCUPIED" plate. Rotating inside knob / lever simultaneously retracts deadbolt and latch bolt, and unlocks outside knob / lever. Rotating outside coin turn retracts deadbolt and unlocks outside knob / lever. Inside knob lever is always free for immediate egress.
		SC8495	Privacy with "OCCUPIED" Indicator	---	Knob / lever retracts latch bolt form either side. Deadbolt thrown or retracted by key outside (retraction by key required in the event of an emergency) or inside thumbturn. Throwing deadbolt locks outside knob / lever and displays "OCCUPIED" plate. Rotating inside knob / lever simultaneously retracts both deadbolt and latch bolt and unlocks outside knob / lever. Inside lever is always free for immediate egress.
		SC8485	Faculty Restroom Lock	---	Latch bolt retracted by key outside or by knob / lever inside. Outside knob / lever is always fixed. Deadbolt thrown or retracted by inside thumbturn. When dead bolt is thrown, all keys become inoperable except emergency or display keys. Turning inside knob / lever retracts both deadbolt and latch bolt simultaneously. Auxiliary latch deadlocks latch bolt when door is closed. Inside knob / lever is always free for immediate egress.
		SC8486	SC8485 with "OCCUPIED" Indicator	---	Latch bolt retracted by key outside or by knob / lever inside. Outside knob / lever always fixed. Deadbolt thrown or retracted by inside thumbturn. When deadbolt is thrown, "OCCUPIED" plate is displayed and all keys become inoperative except emergency keys. Turning inside knob / lever simultaneously retracts both deadbolt and latch bolt. Auxiliary latch deadlocks latch bolt when door is locked. Inside knob / lever is always free for immediate egress.
		SC8411HL SC8411LG	Dormitory / Exit Lock	F11	Latch bolt retracted by lever from either side unless outside lever is made inoperative by operating toggle button. Dead bolt projected by key from either side. Dead bolt retracted by key outside. Operating inside lever retracts both dead bolt and latch bolt simultaneously and outside lever remains locked.
		SC8010 SC8010HL SC8010LG	Passage	F01	Latch bolt operated by lever from either side at all times. Inside lever is always free for immediate exit.
		SC8170	Single Fixed Dummy	---	Lever on one side fixed by mounting bar is always rigid. Lever is used as door pull only.
		SC8172	Double Fixed Dummy	---	Lever on both sides fixed by mounting bar is always rigid. Lever is used as door pull only.

OUTSIDE	INSIDE	SERIES/FUNCTION	TYPE	ANSI	FUNCTION DESCRIPTION
		SC8175	Single Dummy Trim with Lock Case	---	Lever on one side fixed on door surface is always rigid. Includes lock case and armored front.
		SC8176	Double Dummy Trim with Lock Case	---	Lever on both sides fixed on door surface and are always rigid. Includes lock case and blank armor front.
		SC8026LG	Supervisor Office or Privacy Room (Institutional Privacy)	F26	Outside key retracts latch bolt, with override of inside thumbturn when held in locked position. Outside lever retracts latch bolt except when locked by thumbturn. Free exit at all times. Inside lever can be rotated at any time.
		SC8031LG (Asylum-1)	Asylum w/o Inside Cylinder	---	Only outside key retracts latch bolt. Inside and Outside Lever are clutch, free-wheeling.
		SC8032LG (Asylum-2)	Asylum w/ Double Cylinder w/o Inside Lever	---	Outside or inside key retracts latch bolt. Outside Lever is clutch, free-wheeling.
		SC8033LG (Asylum-3)	Asylum w/o Inside Cylinder w/o Inside Lever	---	Only outside key retracts latch bolt. Outside lever is clutch, freewheeling.
		SC8467LG (Asylum-5)	Asylum w/ Deadbolt w/o Inside Cylinder	---	Outside lever retracts both latch bolt and deadbolt simultaneously. Outside key operates deadbolt. Outside lever is operable. Inside lever is clutch, freewheeling.
		SC8468LG (Asylum-6)	Asylum w/ Deadbolt & Double Cylinder w/o Inside Lever	---	Outside or inside key operates deadbolt. Outside Lever is operable unless deadbolted.
		SC8469LG (Asylum-7)	Asylum w/ Deadbolt w/o Inside Cylinder & Inside Lever	---	Outside lever retracts latch bolt. Outside key operates deadbolt. Outside lever can open door except when deadbolted.
		SC8055LG	Female Patient Room-1	---	Outside lever can be turned for entry when unlocked by key. Free exit at all times. Remains locked if exiting. Outside lever is lockable. Inside lever can be rotated at any time.
		SC8056LG	Female Patient Room-2	---	Outside lever can be turned for entry when unlocked by key. Free exit at all times. Remains unlocked if exiting. Inside lever can be rotated at any time.