

HES[®] 8500 Electric Strike

Works with mortise locksets
without a deadbolt up to
a 3/4" throw latchbolt



Also available in
a Complete One
Box Solution

The fire rated, concealed electric strike solution for mortise locksets.

The HES 8500 Series Electric Strike is a fire rated, compact, high performance electric strike featuring a unique concealed design for use with mortise locksets without a deadbolt. Designed for fast, convenient installation, the HES 8500 installs with little or no modification to the frame. Simply remove the existing strike plate, remove the dust box, and install. Its strength is derived from a unique keeper pin locking design, enabling the HES 8500 to exceed Grade 1 ratings. This unique electric strike complies with NFPA 80-07 guidelines for retrofit into fire rated frames. The HES 8500 accommodates mortise latchbolts up to 3/4" throw.

Features

Standard Features

- No cutting to the face of the frame
- Stainless steel construction
- Tamper resistant
- Static strength 1,500 lbs
- Dynamic strength 70 ft-lbs
- Endurance 1 million cycles
- Field selectable fail safe/fail secure
- Non-handed
- Metal frame
- Internally mounted solenoid
- Accommodates 3/4" [19mm] mortise latchbolts
- Strike body depth 1-5/16" [33.3mm]
- Plug-in connector
- Full pocket shims for horizontal adjustment
- SecuriCare five-year, no-fault, no questions asked warranty (Addition of HES SMART Pac[®] III extends the warranty to 10 years)

Optional Features

- **LBM** Latchbolt monitor
- **LBSM** Latchbolt strike monitor
- 4 faceplate option kits to work with most mortise locksets (sold separately)

Accessories

- **2001M** Plug-in bridge rectifier
- **2004M** ElectroLynx[®] adapter
- **2005M3** SMART Pac[®] III
- **2006M** Plug-in buzzer
- **150** Strike latch guard



Grade 1



SecuriCare
Warranty



Mortise Locks
without
Deadbolt



Field Selectable
(Fail secure
/Fail safe)



Dual Voltage
12/24



PoE
Friendly



Fire Rated



Outdoor
Rated



Burglary
Rated

Specifications

Certifications

- ANSI/BHMA A156.31, Grade 1
- UL 1034 burglary-resistant listed and suitable for outdoor use
- UL 294 listed
- RoHS compliant
- UL 10C fire rated, 3-hour single door (fail secure only)
- CAN/ULC-S104 fire door conformant
- NFPA-252 fire door compliant
- ASTM-E152 fire door compliant
- NFPA 80-07 compliant

Frame Application

- Metal

Electrical (DC Continuous Duty)

- Dual voltage 12/24 VDC/VAC
- 240 mA at 12 VDC/120 mA at 24 VDC
- PoE friendly

Dimensions

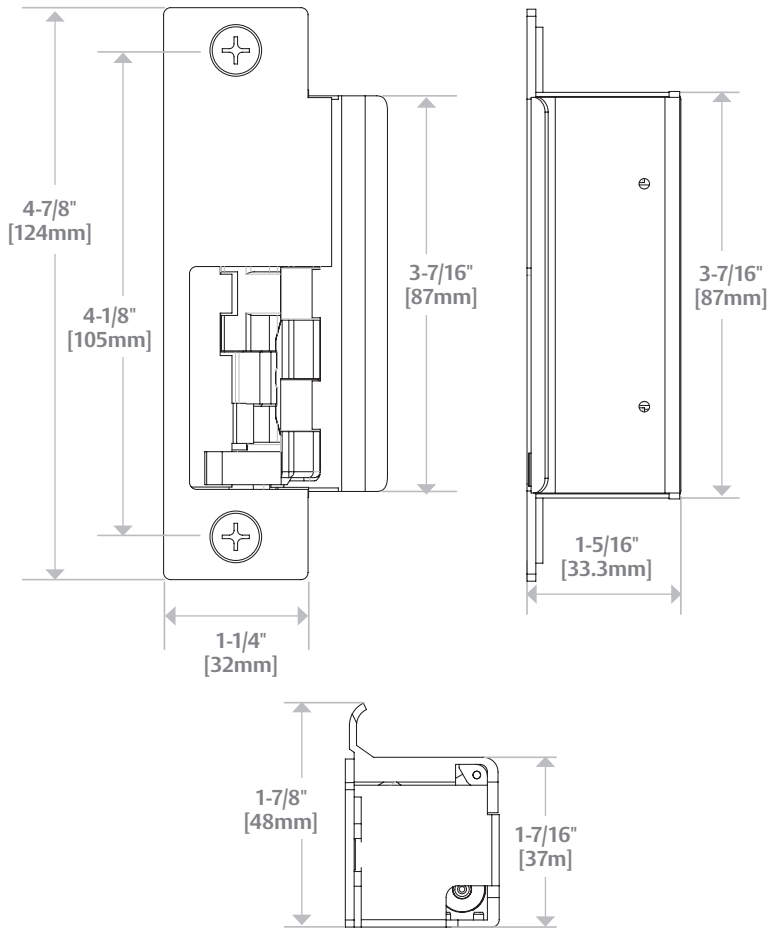

Removal of the dustbox required for use with ANSI/BHMA A156.115 prep

How to Order

SERIES	FINISH	OPTION (S)
8500	- 630	- LBM
8500 Universal Electric Strike; faceplates ordered separately	605 Bright Brass	LBM Latchbolt Monitor
	606 Satin Brass	LBSM Latchbolt Strike Monitor
	612 Satin Bronze	
	613 Bronze Toned	
	629 Bright Stainless Steel	
	630 Satin Stainless Steel	

NOTE: Electric strike compatibility is determined at time of electric strike product release. ASSA ABLOY is not responsible for incompatibility of products that have changed in design or craftsmanship by their respective manufacturers. When compatibility is a concern, contact Customer Support for application assistance.

HES 8500 Series Faceplate Option Kits

The HES 8500 faceplate option kits combine two different faceplate pocket styles with three different deadlatch platform profiles for compatibility with a wide variety of mortise locksets. HES 8500 faceplate option kits are lock specific. There are two faceplates included in each kit: a standard faceplate and a faceplate with a wider pocket to address less-than-ideal sagging door conditions.

OPERATION	 Mortise Locks without Deadbolt	After release, the keeper returns to the locked position.
 4-7/8" x 1-1/4" [123.8mm x 31.75mm]	851M Option For use with: Mortise locksets Compatible locksets: Sargent 8100, 8200, 9200 <i>ANSI/BHMA Numbers: E05031, E09321, E09322, E09323</i>	
 4-7/8" x 1-1/4" [123.8mm x 31.75mm]	852K Option For use with: Mortise locksets Compatible locksets: Corbin Russwin ML 2000 <i>ANSI/BHMA Numbers: E05031, E09321, E09322, E09323</i>	
 4-7/8" x 1-1/4" [123.8mm x 31.75mm]	852L Option For use with: Mortise locksets Compatible locksets: Schlage L9000 <i>ANSI/BHMA Numbers: E05031, E09321, E09322, E09323</i>	
 4-7/8" x 1-1/4" [123.8mm x 31.75mm]	852M Option For use with: Mortise locksets Compatible locksets: Yale 8700 (manufactured after 2005) & 8800, Accurate, Falcon, Kaba Ilco/Unican <i>ANSI/BHMA Numbers: E05031, E09321, E09322, E09323</i>	

Get to Know the HES 8500

The HES 8500 concealed electric strike for mortise locksets builds on the tradition of ground-breaking design you've come to know in the HES 8000 Series concealed electric strike family. It has a unique design unlike any electric strike on the market today. It's important to understand the extraordinary design of the HES 8500 so that you can correctly install and operate it.

When the door is closed, the mortise latchbolt is held secure by the HES 8500 keeper. A 'deadlatch platform' insert holds the deadlatch in its locked state. Place the deadlatch platform into one of three locations in the strike as appropriate for the type of mortise lockset.

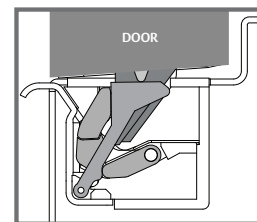

When the electric strike is energized, the keeper begins to rotate and the deadlatch platform falls away, allowing the deadlatch to drop and the latchbolt to become locked.

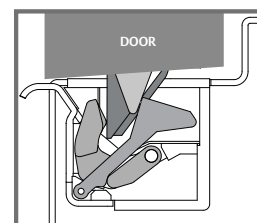

As the door moves forward, the latchbolt slides first along the keeper and then up the internal ramp.

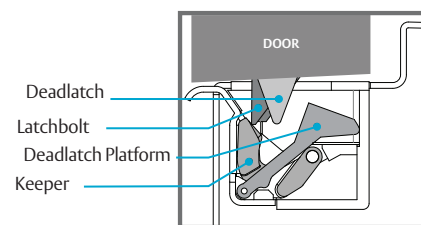

As the door continues along its arc away from the frame, the latchbolt and deadlatch exit the HES 8500, which quickly returns to its locked state.

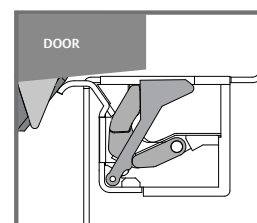





Compatibility Chart

ASSA ABLOY ELECTRONIC SECURITY HARDWARE				ADAMS RITE	VON DUPRIN	RCI	TRINE	SDC
HES COMPLETE ONE BOX SOLUTIONS	HES STANDARD MODELS	SECURITRON COMPLETE ONE BOX SOLUTIONS	HES FOLGER ADAM MODELS					
7000C	7000-791		712, 732	7400, 7401, 7440				
7000C	7000-792			7410, 7411				
				74R1				
				74A				
				74R2				
7501	7501							
8000C	8000-801, 8000-801A, 8300-801, 8300-801A	UNL						
	8000-801E, 8000-802, 8000-803, 8300-801E, 8300-802, 8300-803	UNL						
	8500-851M, 8500-852K, 8500-852L, 8500-852M	MUNL						
9400	9400		310-4	74R2		0563	4850	
9500	9500				6300	F0162	4800F	
9600	9600			74R1		0162	4800	
			310-20B		6222, 6225			
			310-4		6212, VD3146			
9700	9700		310-4S				4801	
			310-4-1, 310-4-2, 310-4-3, 310-4-30					
			310-6-1, 310-6-2, 310-6-3, 301-6-8, 310-6-30					
9800				7800				

NOTE: This chart is offered as a convenience only. Reference should be made to the individual manufacturer's catalogs for complete data as to exact equivalents. There may be some variation in physical size, electrical characteristics and durability between strikes of different manufacturers. ASSA ABLOY Electronic Security Hardware assumes no liability for differences between items compared. When compatibility is a concern, contact Customer Support at 800-626-7590 for application assistance. NOTE: The 109 trim adapter may be required for a neater appearance in retrofit applications where the strike lip dimensions exceed 3-3/8" [85.725mm].

NOTE: This chart details the HES and Folger Adam products that can replace competitors products but not necessarily the reverse.

Lock Cross Reference

ANSI LOCK	DESCRIPTION	MANUFACTURER	ELECTRIC STRIKES
 	Mortise locksets Mortise lockset without a deadbolt	Arrow, Baldwin, Best, Marks, Omnia, PDQ	HES 1006CS, 1600CS, 1006CLB, 1600CLB, 1006KM, 16001LB, 1500C, 4500C, Securitron MUNL
		Corbin Russwin ML2000 and Arrow	HES 1006CS, 1600-CS, 1006CLB, 1600-CLB, 1006-KM, 1600-1LB, 1500C, 4500C, 8500-852K, HES Folger Adam 742-75, Securitron MUNL
		Sargent 7700 and 8100 Schlage L9000	HES 1006CS, 1600-CS, 1006CLB, 1600-CLB, 1006-KD, 1600-1LB, 1500C, 4500C, 8500-851M, (Sargent 8100 only), 8500-852L, HES Folger Adam 742-75, Securitron MUNL
		Sargent 7900, 8200, and 9200	HES 1006CS, 1600-CS, 1006CLB, 1600-CLB, 1006-KM, 1600-1LB, 1500C, 4500C, 8500-851M, 8500-852L, HES Folger Adam 742-75, Securitron MUNL (requires STK-1 tab kit)
		Accurate, Falcon, Kaba Ilco/Unican, Yale 8700 (manufactured after 2005), Yale 8800	HES 1006CS, 1600-CS, 1006CLB, 1600-CLB, 1006-KD, 1600-1LB, 1500C, 4500C, 8500-852M, Securitron MUNL
  	Mortise locksets Mortise lockset with a 1" [25.4mm] deadbolt	Accurate, Almet, Arrow, Baldwin, Best, Marks, Corbin Russwin, Falcon, Omnia, PDQ, Schlage	HES 1006CS*, 1600-CS*, 1006CDB*, 1600-CDB* 1006-HD*, 1006-ND*, 1006CAS
		Sargent, Yale	HES 1006CS*, 1600-CS*, 1006CDB*, 1600-CDB* 1006-HD*, 1006-ND*, 1006CAS

*Not intended for continuous recapture of a 1" [25.4mm] deadbolt - use 1006CAS

NOTE: This chart is offered as a resource only. Electric strike compatibility is determined at time of electric strike product release. ASSA ABLOY is not responsible for incompatibility of products that have changed in design or craftsmanship by their respective manufacturers. When compatibility is a concern, contact Customer Support at 800-626-7590 for application assistance.

ASSA ABLOY Electronic Security Hardware Warranty Policy

In 1999 Securitron® introduced the first no-fault, no questions asked warranty to the industry, MagnaCare®. As a part of HES and Securitron's transition to ASSA ABLOY Electronic Security Hardware, we believe that the best products in the industry should be supported by our commitment to deliver the highest quality products

and services. ASSA ABLOY Electronic Security Hardware is proud to now extend the most comprehensive no-fault, no questions asked warranty coverage to all of our products and solutions. This is our expectation and commitment to you – our valued customer.



MagnaCare Warranty

Duration: Lifetime

Condition: Any reason, including, but not limited to, installation error, vandalism or force majeure.

Replacement: Replacement product or equivalent shipped at ASSA ABLOY Electronic Security Hardware expense via next day air freight in most cases.

Products Covered:

- Electromagnetic and Specialty Locks
- Power Supplies (excluding BPSS) and Power Transfers
- Push Buttons, Keypads, Keyswitches and Egress Devices

ASSA ABLOY Electronic Security Hardware warranties apply to products shipped on or before January 1, 2018.

Check your individual product to determine warranty coverage. Batteries and consumables are not covered by ASSA ABLOY Electronic Security Hardware Warranty programs. Replacement products, at ASSA ABLOY Electronic Security Hardware's sole option, may be the identical item or a unit which serves as a functional replacement. If the customer has an account with ASSA ABLOY Electronic Security Hardware or a valid credit card, the customer may order an advance replacement product, whereby ASSA ABLOY Electronic Security Hardware will charge the customer's account for the price of the product plus next day air freight, and will credit back to the customer the full amount of the charge, including outbound freight, upon ASSA ABLOY Electronic Security Hardware's receipt of the original product from the customer. ASSA ABLOY Electronic Security Hardware's sole and exclusive liability, and customer's sole remedy, is limited to the replacement of the ASSA ABLOY Electronic Security Hardware product when delivered to ASSA ABLOY Electronic Security Hardware's facility (freight and insurance charges prepaid by customer).

Customers purchasing from Door Security Solutions Canada can find Canadian terms and conditions at assaabloy.ca/terms



SecuriCare 10-year Warranty

Duration: Ten years from date of shipment

Condition: Any reason including, but not limited to, installation error, vandalism or force majeure

Replacement: Replacement product or equivalent shipped at ASSA ABLOY Electronic Security Hardware expense via next day air freight in most cases.

Products Covered:

- HES 1500, 1600 Electric Strikes
- When installed with a HES Smart PAC III, the following electric strikes are upgraded to the 10-year warranty:
 - » HES 1006, 4500, 5000, 5200, 7500, 8000, 8300, 8500, 9400, 9500, 9600, 9700, 9800, HES Folger Adam 310, 712, 732, 742 Electric Strikes
 - » Integrated Wiegand Electric Strikes



SecuriCare 5-year Warranty

Duration: Five years from date of shipment

Condition: Any reason including, but not limited to, installation error, vandalism or force majeure.

Replacement: Replacement product or equivalent shipped at ASSA ABLOY Electronic Security Hardware's expense via next day air freight in most cases.

Products Covered:

- HES 1006, 4500, 5000, 5200, 7500, 8000, 8300, 8500, 9400, 9500, 9600, 9700, 9800, HES Folger Adam 310, 712, 732, 742 Electric Strikes
- Integrated Wiegand Electric Strikes
- Securitron MUNL, UNL Electric Strikes



SecuriCare 3-year Warranty

Duration: Three years from date of shipment

Condition: Any reason, including but not limited to, installation error, vandalism or force majeure

Replacement: Replacement product or equivalent shipped at ASSA ABLOY Electronic Security Hardware's expense via next day air freight in most cases.

Products Covered:

- Aperio® Wireless Products K100, KS100, R100
- HES 610, 660, K20, KP20, Cabinet Locks
- Integrated Wiegand Cabinet Locks HES K200, KS200, 630REL, K200-630REL
- BPSS Solar Power Supplies
- Accessories