

Specifications

Certifications

- ANSI/BHMA A156.31, Grade 1
- UL 1034 burglary-resistant listed and suitable for outdoor use
- UL 294 listed
- RoHS compliant

Frame Application

- Metal
- Wood
- Aluminum

Electrical (DC Continuous Duty)

- Dual voltage 12/24 VDC/VAC
- 240 mA at 12 VDC/120 mA at 24 VDC
- PoE friendly

Dimensions

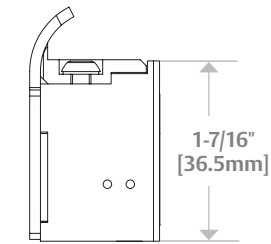
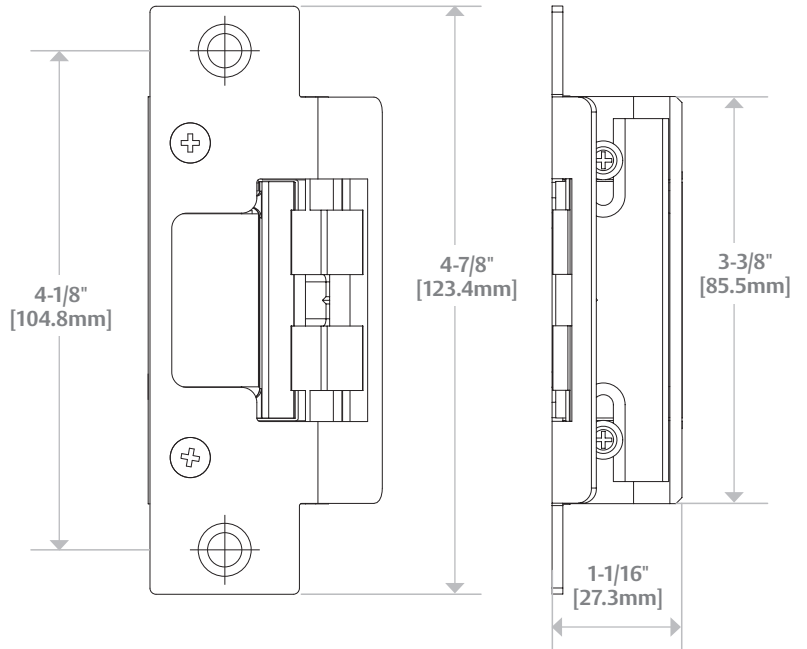

Diagram shown with 801 Option

How to Order

SERIES	MODEL	FINISH	OPTION (S)
8000	—	— 630	— LBM
8000 Universal Electric Strike; faceplates ordered separately	C* Complete Electric Strike; includes the 801 and 801A faceplates	605 Bright Brass 606 Satin Brass 612 Satin Bronze 613 Bronze Toned 629 Bright Stainless Steel 630 Satin Stainless Steel BLK Black	LBM Latchbolt Monitor

*Complete Pacs are only available in the 630 finish

NOTE: Electric strike compatibility is determined at time of electric strike product release. ASSA ABLOY is not responsible for incompatibility of products that have changed in design or craftsmanship by their respective manufacturers. When compatibility is a concern, contact Customer Support for application assistance.

Specifications

Certifications

- ANSI/BHMA A156.31, Grade 1
- UL 1034 burglary-resistant listed and suitable for outdoor use
- UL 294 listed
- RoHS compliant
- UL 10C fire rated, 3-hour single door (fail secure only)
- CAN/ULC-S104 fire door conformant
- NFPA-252 fire door compliant
- ASTM-E152 fire door compliant
- NFPA 80-07 compliant

Frame Application

- Metal
- Wood
- Aluminum

Electrical (DC Continuous Duty)

- Dual voltage 12/24 VDC/VAC
- 240 mA at 12 VDC/120 mA at 24 VDC
- PoE friendly

Dimensions

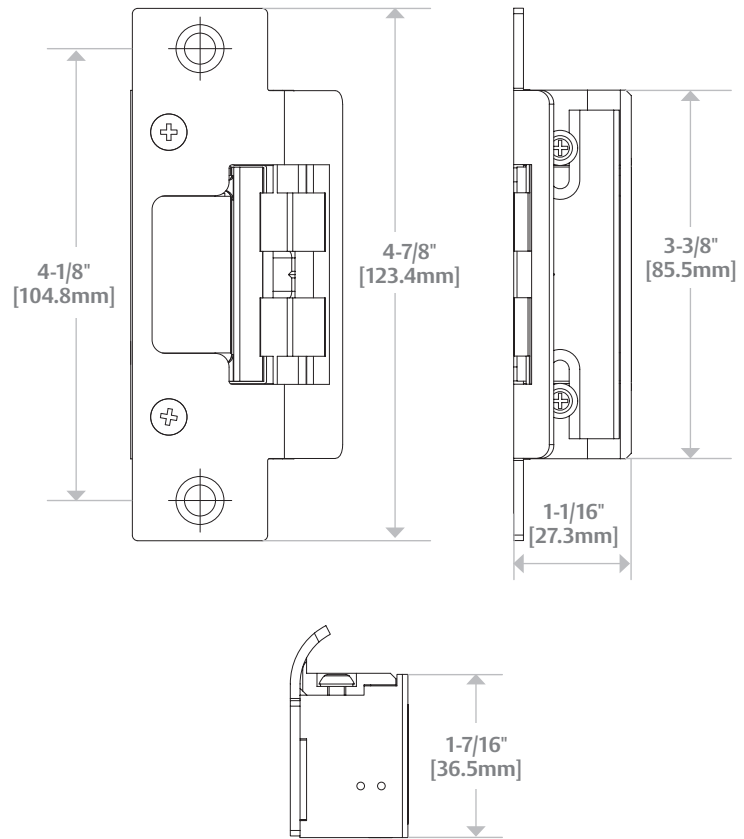

Diagram shown with 801 Option













How to Order

SERIES	MODEL	FINISH	OPTION (S)
8300	—	— 630	— LBM
8300 Universal Electric Strike; faceplates ordered separately	C* Complete Electric Strike; includes the 801 and 801A faceplates	605 Bright Brass 606 Satin Brass 612 Satin Bronze 613 Bronze Toned 629 Bright Stainless Steel 630 Satin Stainless Steel BLK Black	LBM Latchbolt Monitor

*Complete Pacs are only available in the 630 finish

NOTE: Electric strike compatibility is determined at time of electric strike product release. ASSA ABLOY is not responsible for incompatibility of products that have changed in design or craftsmanship by their respective manufacturers. When compatibility is a concern, contact Customer Support for application assistance.

HES 8000/8300 Series Faceplate Options

OPERATION	 After releasing the latchbolt, the keeper returns to the locked position.	
 <p>4-7/8" × 1-1/4" [123.8mm x 31.75mm] Square corners</p>	<p>801 Option</p> <p>For use with: Cylindrical locksets in ANSI metal jambs, with latchbolts up to 5/8" [15.9mm] throw.</p> <p>ANSI/BHMA Numbers: E05031, E09321, E09322, E09323</p>	
 <p>4-7/8" × 1-1/4" [123.8mm x 31.75mm] Radius corners and flat faceplate</p>	<p>801A Option</p> <p>For use with: Cylindrical locksets with latchbolts up to 5/8" [15.9mm] throw. Includes universal mounting tabs. Aluminum frames.</p> <p>ANSI/BHMA Numbers: E05031, E09321, E09322, E09323</p>	
 <p>4-7/8" × 1-1/4" [123.8mm x 31.75mm] 1/4" extended lip</p>	<p>801E Option</p> <p>For use with: Extended lip for 'knock-down' style frame installations. For use with cylindrical latchbolts up to 5/8" [15.9mm] throw.</p> <p>ANSI/BHMA Numbers: E05031, E09321, E09322, E09323</p>	
 <p>7-15/16" × 1-7/16" [201.6mm x 36.5mm]</p>	<p>802 Option</p> <p>For use with: Cylindrical locksets with latchbolts up to 5/8" [15.9mm] throw. Includes universal mounting tabs. Aluminum frames.</p> <p>ANSI/BHMA Numbers: E05031, #E09321, E09322, E09323</p>	
 <p>6-7/8" × 1-1/4" Radius corners and flat faceplate</p>	<p>803 Option</p> <p>For use with: Cylindrical locksets with latchbolts up to 5/8" [15.9mm] throw. Includes universal mounting tabs. Aluminum frames.</p> <p>ANSI/BHMA Numbers: E05031, E09321, E09322, E09323</p>	
 <p>9" × 1-3/8" [123.8mm x 34.9mm] Radius corners and flat faceplate</p>	<p>805 Option</p> <p>For use with: Cylindrical locksets. Latchbolts up to 5/8" [15.9mm] throw. Four point mounting for wood installations.</p> <p>ANSI/BHMA Numbers: #E05031, #E09321, #E09322, #E09323</p>	

"For use with" information is offered as a recommendation only. Reference should be made to the lockset manufacturer for proper installation instructions necessary to meet compatibility requirements.

Compatibility Chart

ASSA ABLOY ELECTRONIC SECURITY HARDWARE				ADAMS RITE	VON DUPRIN	RCI	TRINE	SDC
HES COMPLETE ONE BOX SOLUTIONS	HES STANDARD MODELS	SECURITRON COMPLETE ONE BOX SOLUTIONS	HES FOLGER ADAM MODELS					
7000C	7000-791		712, 732	7400, 7401, 7440				
7000C	7000-792			7410, 7411				
				74R1				
				74A				
				74R2				
7501	7501							
8000C	8000-801, 8000-801A, 8300-801, 8300-801A	UNL						
	8000-801E, 8000-802, 8000-803, 8300-801E, 8300-802, 8300-803	UNL						
	8500-851M, 8500-852K, 8500-852L, 8500-852M	MUNL						
9400	9400		310-4	74R2		0563	4850	
9500	9500				6300	F0162	4800F	
9600	9600			74R1		0162	4800	
			310-20B		6222, 6225			
			310-4		6212, VD3146			
9700	9700		310-4S				4801	
			310-4-1, 310-4-2, 310-4-3, 310-4-30					
			310-6-1, 310-6-2, 310-6-3, 301-6-8, 310-6-30					
9800				7800				

NOTE: This chart is offered as a convenience only. Reference should be made to the individual manufacturer's catalogs for complete data as to exact equivalents. There may be some variation in physical size, electrical characteristics and durability between strikes of different manufacturers. ASSA ABLOY Electronic Security Hardware assumes no liability for differences between items compared. When compatibility is a concern, contact Customer Support at 800-626-7590 for application assistance. NOTE: The 109 trim adapter may be required for a neater appearance in retrofit applications where the strike lip dimensions exceed 3-3/8" [85.725mm].

NOTE: This chart details the HES and Folger Adam products that can replace competitors products but not necessarily the reverse.