

DCN516

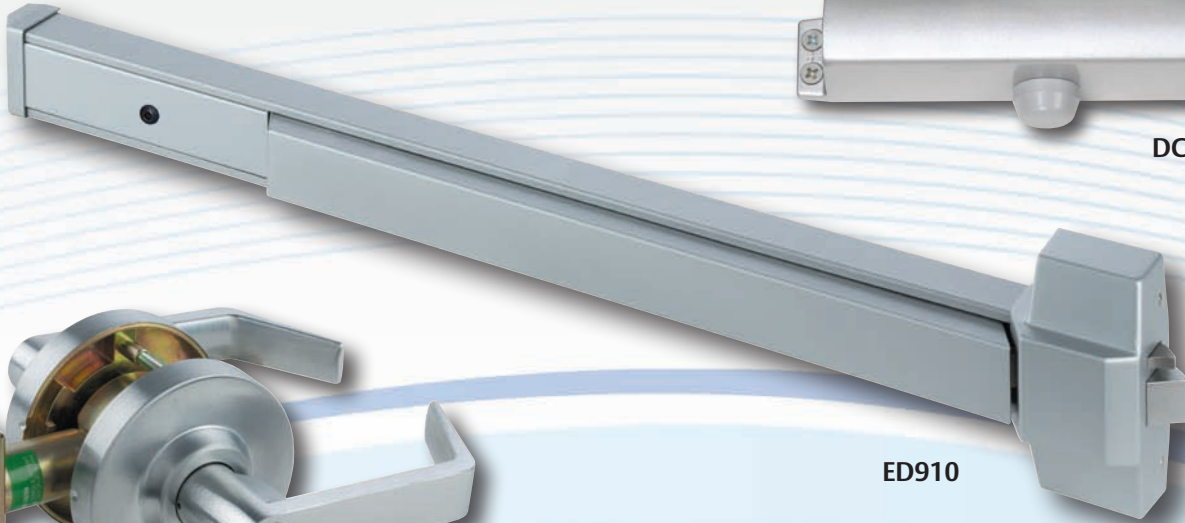

DCN325



ED910

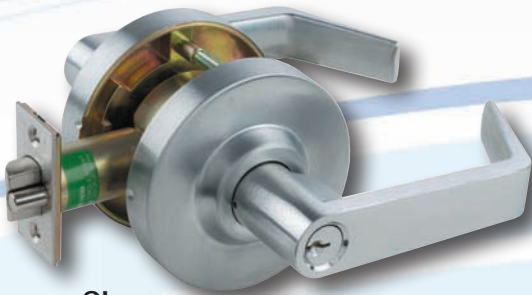

QL



MLX

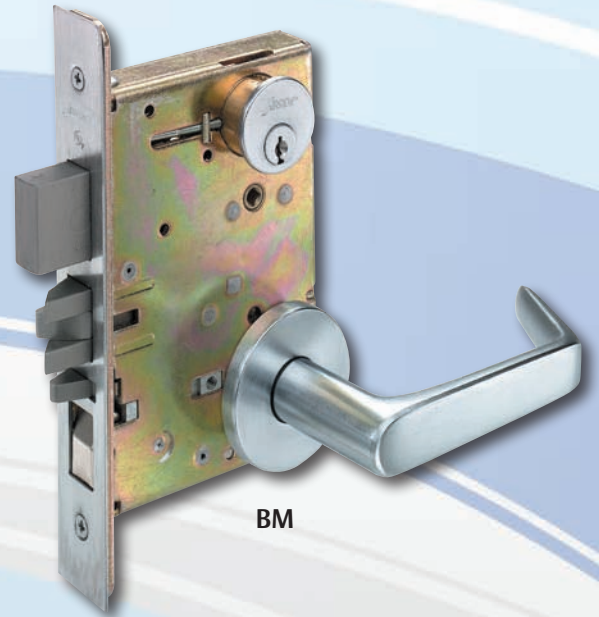

BM

All products
shown are



Arrow 2020 Price Book
Effective March 16, 2020



ASSA ABLOY

Experience a safer
and more open world



ASSA ABLOY



ARROW USA

Dock 2
225 Episcopal Road
Berlin, CT 06307
Phone: (800) 839-3157
Fax: (800) 421-6615
info@arrowlock.com

ORDERS & CUSTOMER SERVICE:

Arrow Lock & Door Hardware

P.O. Box 3075
Salem, VA 24153
Phone USA: 800-839-3157
Fax: 800-421-6615

INVOICE PAYMENTS ONLY

Arrow Lock Accounts Receivable

P.O. Box 640711
Pittsburgh, PA 15264

RETURN GOODS ONLY (RGA# REQUIRED)

Arrow Lock & Door Hardware

Dock 2
225 Episcopal Road
Berlin, CT 06307



Arrow Canada

160 Four Valley Drive
Vaughan, ON L4K 4T9
Canada

Phone: 1.800.461.3007
Fax: 1.800.461.8989

Note: The prices contained in this price book will vary from those in our Canadian price book.



Terms & Conditions of Sale

Acceptance

ARROW LOCK reserves the right to decline an order, in whole or in part, when the type or quantity of goods or credit worthiness of the Purchaser is not satisfactory to us in our sole and absolute discretion.

Purchase Orders, Quote requests, Acknowledgements or the like issued by the Purchaser that have contrary standard terms and conditions are not binding on ARROW LOCK, unless such terms and conditions are approved in a separate written agreement by ARROW LOCK's authorized representatives. In the event of an acceptance of Purchaser's Purchase Order by ARROW LOCK, the Purchaser agrees that such acceptance is solely conditioned on Purchaser's acceptance of the terms and conditions set forth in this instrument, regardless of the terms and conditions specified in the Purchaser's Purchase order. The terms and conditions in Purchaser's Purchase order which conflict with terms and conditions of this instrument shall be disregarded and are hereby rejected, and this instrument shall constitute the entire agreement between ARROW LOCK and the Purchaser.

In the event that ARROW LOCK does not enforce or require strict performance of any term or condition hereof, or of any other document, instrument or other agreement relating to goods sold, such lack of enforcement or requirement of strict performance will not waive, affect or diminish any right of ARROW LOCK to enforce or require strict performance of such term or condition in the future.

Prices

All prices are subject to change without notice and are not guaranteed. All shipments will be made at prices in effect at the time of order acceptance.

Possession of this price list does not constitute an agreement to sell. We reserve the right to correct clerical, stenographic and other obvious errors at any time.

Terms

2% 10 net 30 days after invoice date.

It is understood that ARROW LOCK may impose and charge a finance charge which is the lesser or one and one-half percent (1-1/2%) per month or the highest rate allowed by law on any amount which becomes past due and delinquent. Additionally the customer shall be responsible for all collection costs, court costs and reasonable attorney's fees (where allowed by law) in connection with the recovery of any delinquent amount.

Freight

All orders are shipped FOB factory/warehouse, except as expressly provided below. When delivered to the Transportation Company, the Purchaser assumes the risk of loss or damage in transit.

Customer orders with net product value in excess of \$5,000.00 will be shipped prepaid by ARROW LOCK's carrier of choice and routing to a single destination point in the United States.

Customer orders with net product value less than \$5,000.00 will be shipped prepaid by ARROW LOCK's carrier of choice and routing and shipping and handling charges will be added to customer's invoice.

If the customer requests an expedited method of shipment such as "Next Day Air" the charges will be prepaid by ARROW LOCK and the full rate for the service, as published by the carrier, will be added to the customer's invoice.

Great Grand Master keys, Grand Master keys, Master keys, Construction Master keys, Control Keys, which are shipped separate from customer order for security reasons, on orders with net product value in excess of \$5,000 will be shipped prepaid by ARROW LOCK's carrier of choice. If the total order value is less than \$5,000.00, the shipping charges will be added to customer's invoice.

ARROW LOCK will pack, mark and ship the products according to its standard procedures for shipment, unless the parties agree, in writing, that ARROW LOCK will comply with any special instructions provided by the customer. Special instructions must be submitted, in writing, at time of order placement. Compliance with special instructions may result in an increased price.

Terms & Conditions of Sale

Minimum Invoice

Minimum invoice for complete product is \$200.00 net product value. The minimum invoice for parts orders is \$100.00 net product value. In the event that the net product value does not meet the required net minimum, ARROW LOCK may, at its sole discretion (a) apply a minimum order charge, (b) reject the order or (c) waive the minimum requirement provided that the waiver of the requirement for one order shall not constitute a waiver of the requirement for any future orders.

This policy does not include the following: Cut (bitted) Keys of any type, Master Keyed Cylinders, Master Keyed Padlocks and factory-generated bitting Lists.

Same day order expedites will be invoiced at book net.

Quotations

If ARROW LOCK elects to offer a quote; such quote will be valid until the expiration date on that quote. Complete shipment of the order must be accepted by Purchaser within standard lead times.

The quote number must be referenced on the order. Any invoiced order that has the incorrect discount applied to it and did not have the quote number written on the order will have a service fee of \$100.00 net DEDUCTED from any sales credit issued for the difference in discount.

The quote is null and void if the Purchase Order does not include ALL product lines listed on the quote or if the quantities for an item covered by the quote deviate by 10% or more.

With the issuance and acceptance of a quote for the purchase of products, the Purchaser agrees that products so purchased will not be resold or transferred to any Distributor not authorized by ARROW LOCK to sell its products. This would be inclusive of branches of the quoted Distributor. Failure to abide by this restriction may result in the Distributor's ineligibility for Price Concession Authorizations, or other actions in ARROW LOCK's discretion.

ARROW LOCK and its sales representatives reserve the right, in their sole discretion and for any reason, to refuse a Distributor's request to quote a price other than ARROW LOCK's standard list price and regardless of whether ARROW LOCK or its sales representatives have previously quoted discounted prices to the Distributor on some or all of its orders.

Non-Cataloged Products

Products not cataloged or listed in this price book will be considered as special products, and will not be manufactured without prior approval from ARROW LOCK. All non-cataloged goods cannot be changed or cancelled.

A minimum special handling charge of \$50.00 will be added for non-cataloged product. Any additional labor or material required will be charged accordingly. Any additional labor or material required will be charged accordingly.

Special products require special handling, and therefore standard lead times may not apply. Please consult with your Sales Representative for further details.

Change or Cancellation of Orders

Changes or cancellations to an order will result in a charge of costs for material and labor expenses that have been incurred prior to notification from customer. Handling charges are billed on customer's original order. If products have already been made and/or are located in the shipping room, a 45% restocking fee will apply.

Arrow Express Orders may not be changed or cancelled.

Except for the reasons stated above, all change requests must be submitted in writing to customer Service within two (2) business days of receipt of acknowledgement of the order.

Add-On Orders to Quote

Any new order requesting special pricing to match an existing quote number, which has already been ordered, will be accepted up to sixty (60) days after the acknowledgement of the original order. All add-on orders must reference the original factory order number and the corresponding quote number to receive the quoted pricing discount. Add-on orders for stock will not be accepted.

**ASSA ABLOY**

Terms & Conditions of Sale

Delivery

Orders will be acknowledged and given a scheduled delivery date based on estimated manufacturing lead times. Complete information is required to process all orders. Orders with insufficient information for processing (i.e. keying information, door sizes, etc.) may be subject to extended lead times which are relative to the time required in obtaining the necessary information for order processing. Manufacturing lead time will begin once all information is received to process an order. ARROW LOCK will use reasonable efforts to deliver products as estimated, but makes no guarantees as to delivery dates.

ARROW LOCK will not be liable for back charges incurred based on availability of product or as a result of delays in delivery caused by insufficient information required to process an order.

ARROW LOCK will not be held responsible for delays in delivery caused by strikes, fires, floods or any other causes beyond our control, including the delivery of material to us. Under no circumstances shall ARROW LOCK be liable or accountable for consequential damages due to failure of delivery.

Claims

In the event of Company or customer error, claims for shortages, pricing errors and/or incorrectly filled orders must be submitted in writing to Customer Service within thirty (30) days from receipt of material.

Any claims for shortages or damage by the Carrier must be made by the customer directly to the Carrier.

Invoice Deduction

An ARROW LOCK Sales Representative or Customer Service Representative must be notified of any disputed invoices within sixty (60) days from the date of invoice. Deductions should only be taken for the disputed amount and the balance of the invoice is due and payable within standard payment terms.

Returned Goods

It is the policy of ARROW LOCK to not accept returns of any materials that are correctly furnished as per the Distributor's Purchase Order. Return of product due to customer order error or accommodation must be pre-arranged with ARROW LOCK and approved in writing by Sales Management.

All products returned as "Goodwill" must meet the following criteria to be considered a return:

- Be in original, unmarked, and undamaged cartons
- Be valued in excess of \$200.00 net
- Shipped and invoiced within the previous one-hundred twenty (120) days
- Custom, non-cataloged goods, master-keyed or ARROW LOCK Arrow Express shipped products are not returnable

A MINIMUM restocking fee of 45% will be charged. Upon receipt and verification by ARROW LOCK that the returned merchandise meets the foregoing conditions, a credit will be issued for the original invoice amount less the MINIMUM 45% restocking fee. Defective goods and "Goodwill" products that meet the foregoing criteria may be returned by fulfilling the following conditions:

- Send an RGA request in writing to the ARROW LOCK Sales Representative serving the Purchaser's area
- Ensure the RGA labels that are sent to Purchaser by ARROW LOCK are visible on return goods shipment
- Ensure that the RGA number appears on the return shipment label and is legible
- Return the authorized merchandise within sixty (60) days from the date of RGA issuance date
- Return shipments must be freight prepaid to the location specified on the RGA. ARROW LOCK is not liable for damages to product during shipping.

No credit may be taken or issued prior to RGA approval and receipt of product. All defective goods within the terms of our limited warranty may be returned for credit or replacement.



ASSA ABLOY

March 16, 2020

Limited Warranty/
Conditions of Sale

Terms & Conditions of Sale

Taxes

Prices do not include any present or future Federal, State, or Local property, license, privilege, sales, use, and excise, gross receipts or other like taxes or assessments, which may result from transactions or any services performed in connection herewith.

Governing Law

The rights and obligations of the parties shall be governed by the laws of the State of New York, excluding any conflicts of law provisions. The United Nations Convention on Contracts for the International Sale of Goods shall not apply to this Agreement.

Limited Warranty

The Terms and Conditions outlined above are subject to ARROW LOCK Limited Warranty, which is included in this Price List and incorporated herein by reference.

Product Modifications

ARROW LOCK products are not designed for or intended for aftermarket modification. The warranty on ARROW LOCK products becomes void if the product is modified in any way, regardless of whether the modification causes or contributes to any alleged defect. Warranty voiding modifications include, but are not limited to, third-party electrification of non-electric products and/or the installation of non-approved or non-ARROW LOCK components.

If an ARROW LOCK product is modified it no longer meets industry certification and quality control standards applicable to the original product and is no longer a genuine ARROW LOCK product. A modified product may not be sold as an ARROW LOCK product and no ARROW LOCK trademarks or certification marks based on the original ARROW LOCK product, such as U.L. or ANSI/BHMA marks, may appear anywhere on the modified product or on any packaging, literature or instructions sold with the modified product.

All original ARROW LOCK packaging and literature carrying ARROW LOCK trademarks and must be destroyed if the original ARROW LOCK product is modified. Portions of the product that carry an ARROW LOCK trademark or certification mark, such as mortise faceplates, lock bodies, etc. must be discarded and/or replaced by the party making the modification. U.L. and other certification testing and marking are also the responsibility of the party making modification. The use of ARROW LOCK trademarks on modified products constitutes trademark infringement.

Individual Components

Component parts including but not limited to latches sold separate from locksets are intended to be sold as replacement components for appropriate ARROW LOCK products only. All other uses require prior written approval from ARROW LOCK.

Fire-Rated Openings

Any retrofit or other field modification to a fire-rated opening can potentially impact the fire rating of the opening, and ARROW LOCK makes no representations or warranties concerning what such impact may be in any specific situation. When retrofitting any portion of an existing fire-rated opening, or specifying and installing a new fire-rated opening, please consult with a code specialist or local code official (Authority Having Jurisdiction) to ensure compliance with all applicable codes and ratings.

Technical Information and Advice

(a) All designs, data, and specifications provided by ARROW LOCK are proprietary and will not be disclosed or reused by customer without the prior written consent of ARROW LOCK; (b) ARROW LOCK assumes no obligation or liability for any advice given by ARROW LOCK, the results obtained, or damages incurred, and all such advice is given and accepted at customer's risk.

Trademark Use

ARROW LOCK is a registered trademark of ARROW LOCK Manufacturing Company.

Other product brand names may be trademarks or registered trademarks of their respective owners and are mentioned for reference purposes only.

Experience a safer
and more open world



Limited Warranty

Limited Warranty

ARROW LOCK warrants that its products sold under the ARROW LOCK trade name in the United States of America are free from defects in workmanship and materials under normal use and service.

This warranty does not cover defects or damage arising from improper installation, lack of or improper maintenance, improper storage, shipping and handling, corrosion, erosion, ordinary wear and tear, misuse, abuse, accident, unauthorized service, or use with unauthorized non-ARROW LOCK products or parts. This warranty is void if any modification is made to the warranty product, regardless of whether the modification causes or contributes to the alleged defect. All modifications are made at the risk of the party making the modification.

The only liability of ARROW LOCK in tort or contract whether under this warranty or otherwise shall be limited to the repair or replacement of any product or component part which shall prove defective as covered by this warranty. The warranty period after delivery to the original purchaser in all cases is as follows:

Locks

| | |
|------------------------|----------|
| AM & BM Series | 5 Years |
| CL Series | 5 Years |
| GL Series | 5 Years |
| HK Series | 10 Years |
| MLX Series | 10 Years |
| QL Series | 10 Years |
| RKN & RLN Series | 5 Years |
| RK & RL Series | 5 Years |
| RLX Series | 10 Years |

Door Controls

| | |
|--------------------------|-----------------|
| 5016N Series | 10 Years |
| 7700 Series | 1 Year |
| 7800 & 7900 Series | 2 Years |
| DCN300 Series | 5 Years Limited |
| DCN500 Series | 10 Years |

Exit Devices

| | |
|-----------------------------|----------|
| 3000 & 4000 Series | 5 Years |
| ED910 & PEC910 Series | 10 Years |
| S1150 & S1250 Series | 3 Years |

Other

All other ARROW LOCK products.....1 year

Warranty Requirements for Cylinders Factory or Field Combined

Cylinders shall be periodically lubricated depending on environmental conditions. Petroleum based lubricant is recommended. Petroleum based liquid lubricants should only be used in cylinders in harsh or corrosive environments and should never be mixed with dry lubricants.

Warranty for cylinders Field Combined

1. Keys shall be cut to the ARROW LOCK key biting specifications required for the particular keyway and depth system.
2. All pin lengths shall be selected according to prevailing factory standards.
3. Original ARROW LOCK cylinder components, including pin tumblers and key blanks, shall be used. We reserve the right to void the warranty if we deem that a malfunction is a result of non-original components which do not conform to ARROW LOCK® standards.

Keying Systems

All bittings shall be originated or authorized by the ARROW LOCK Key Systems Department to be compatible with one another in a specific type of cylinder (conventional, security, high security, interchangeable core, removable core) and within a particular keying system.

General Procedure/Finishes

General Procedure

ARROW LOCK will not pay for the cost of repair, replacement, or associated charges under this warranty unless prior written authorization has been given by ARROW LOCK.

Refer to our Returned Goods Policy regarding the return of a product or component part believed to be defective as covered by this warranty. A brief description of the defect will be required. Product will be examined upon return. In the event such examination reveals a defect covered by this warranty, the product will be repaired or replaced.

THIS WARRANTY IS IN LIEU OF ALL OTHER EXPRESS WARRANTIES. TO THE EXTENT PERMITTED BY LAW, ALL IMPLIED WARRANTIES ARE LIMITED TO THE DURATION OF THIS WARRANTY. ARROW LOCK MANUFACTURING COMPANY SHALL NOT BE LIABLE FOR ANY INCIDENTAL OR CONSEQUENTIAL DAMAGES. NO AGENT, SALES REPRESENTATIVE OR DEALER HAS THE AUTHORITY TO INCREASE OR ALTER THE OBLIGATIONS OF THIS WARRANTY.

SOME STATES DO NOT ALLOW LIMITATIONS ON HOW LONG AN IMPLIED WARRANTY LASTS OR THE EXCLUSION OR LIMITATION OF INCIDENTAL OR CONSEQUENTIAL DAMAGES, SO THE ABOVE LIMITATIONS OR EXCLUSIONS MAY NOT APPLY TO YOU.

THIS WARRANTY GIVES YOU SPECIFIC LEGAL RIGHTS, AND YOU MAY ALSO HAVE OTHER RIGHTS WHICH VARY FROM STATE TO STATE.

Finishes

| Description | Arrow Code | BHMA Code | U.S. Code |
|--|------------|-----------|-----------|
| Bright brass | 03 | 605 | US3 |
| Satin brass | 04 | 606 | US4 |
| Antique brass | 05A | 609 | US5 |
| Satin bronze | 10 | 612 | US10 |
| Dark oxidized satin bronze, oil rubbed | 10B | 613 | US10B |
| Dark oxidized satin bronze, equivalent | 10BE | 613E | US10BE |
| Dark oxidized satin bronze, clear coated | 10BP | 614 | US10BL |
| Satin nickel | 15 | 619 | US15 |
| Bright chromium plated | 26 | 625 | US26 |
| Satin chromium plated | 26D | 626 | US26D |
| Bright stainless steel | 32 | 629 | US32 |
| Satin stainless steel | 32D | 630 | US32D |

| Description | Arrow Code | BHMA Code | |
|---------------------------------------|------------|-----------|---|
| Aluminum painted or powder coated | AL | 689 | - |
| Black painted or powder coated | BLK | 693 | - |
| Dark bronze painted or powder coated | BRZ/DBZ | 690 | - |
| Satin brass painted or powder coated | GL | 696 | - |
| Light bronze painted or powder coated | LBZ | 691 | - |
| Red painted or powder coated | RD | - | - |
| Black suede powder coated | BSP | - | - |

- Not all finishes are available for all product lines. Consult product sections for applicable finishes.

AM Series

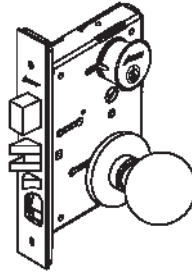

Features

| | |
|---------------------|--|
| Certification | BHMA A156.13, Series 1000, Operationsl Grade 1, UL Listed |
| Door Thickness | 1-3/4" |
| Strike | Standard: ANSI 1-1/4" x 4-7/8", straight lip, with box; curved lip available |
| Latch | 3/4" throw, stainless steel |
| Bolt | 1" throw, stainless steel |
| Backset | 2-3/4" |
| Cylinder | Standard: 6-pin, solid brass, 2 nickel-silver keys; IC prep available |
| Handing | Handed, field reversible without disassembling lock case |
| Case Quantity | 10 |
| Average Case Weight | 58 lbs. |
| Warranty | 5 years |

| Available Finishes | Arrow Code | BHMA Code | U.S. Code |
|--|------------|-----------|-----------|
| Bright brass | 03 | 605 | US3 |
| Satin brass | 04 | 606 | US4 |
| Satin bronze | 10 | 612 | US10 |
| Dark oxidized satin bronze, oil rubbed | 10B | 613 | US10B |
| Dark oxidized satin bronze, equivalent | 10BE | 613E | US10BE |
| Bright chromium plated | 26 | 625 | US26 |
| Satin chromium plated | 26D | 626 | US26D |
| Satin stainless steel | 32D | 630 | US32D |

How to Order

| | |
|----------|-----------------------------------|
| Function | AM11 |
| Trim | AM11-HTHA |
| Finish | AM11-HTHA-26D |
| Strike | AM11-HTHA-26D-460 |
| Handing | AM11-HTHA-26D-460-RH |
| Keying | AM11-HTHA-26D-460-RH-KD-AR |

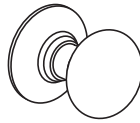

TA

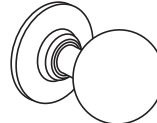

BD

Non-Keyed Functions

| Function | ANSI | Description | 26D | 03, 04, 10, 10B, 10BE, 26 |
|----------|------|-------------|----------|---------------------------|
| AM01 | F01 | Passage | \$426.00 | \$466.00 |
| AM02 | F19 | Privacy | \$498.00 | \$538.00 |
| AM07 | - | Exit | \$557.00 | \$577.00 |
| AM26 | F22 | Privacy | \$498.00 | \$538.00 |

Single Cylinder Functions

| Function | ANSI | Description | 26D | 03, 04, 10, 10B, 10BE, 26 |
|----------|---------|-----------------------|----------|---------------------------|
| AM11 | F12 | Apartment | \$598.00 | \$638.00 |
| AM12 | F07 | Storeroom | \$591.00 | \$631.00 |
| AM13 | F21 | Front Door | \$598.00 | \$638.00 |
| AM17 | F05 | Classroom | \$591.00 | \$631.00 |
| AM19 | F13 | Dormitory | \$598.00 | \$638.00 |
| AM20 | F20 | Entrance | \$598.00 | \$638.00 |
| AM21 | F08/F10 | Entrance | \$598.00 | \$638.00 |
| AM22 | F04 | Office | \$591.00 | \$631.00 |
| AM23 | - | Vestibule | \$591.00 | \$631.00 |
| AM24 | - | Storeroom | \$591.00 | \$631.00 |
| AM27 | - | Institutional Privacy | \$591.00 | \$631.00 |

Double Cylinder Functions

| Function | ANSI | Description | 26D | 03, 04, 10, 10B, 10BE, 26 |
|----------|------|-------------|----------|---------------------------|
| AM31 | F14 | Storeroom | \$625.00 | \$665.00 |
| AM32 | F09 | Vestibule | \$621.00 | \$661.00 |
| AM33 | - | Storeroom | \$621.00 | \$661.00 |
| AM34 | - | Storeroom | \$625.00 | \$665.00 |
| AM37 | F32 | Classroom | \$621.00 | \$661.00 |

AM Series Knob Designs & Deadlocks



TG



TH

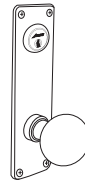

BG

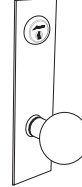

BH

Non-Keyed Functions

| Function | ANSI | Description | 26D | 03, 04, 10, 10B, 10BE, 26 |
|----------|------|--------------|----------|---------------------------|
| AM01 | F01 | Passage | \$444.00 | \$484.00 |
| AM02 | F19 | Privacy | \$516.00 | \$556.00 |
| AM07 | - | Exit | \$566.00 | \$586.00 |
| AM26 | F22 | Privacy | \$516.00 | \$556.00 |
| AM08 | - | Single Dummy | \$206.00 | \$226.00 |
| AM09 | - | Full Dummy | \$377.00 | \$417.00 |

Single Cylinder Functions

| Function | ANSI | Description | 26D | 03, 04, 10, 10B, 10BE, 26 |
|----------|---------|-----------------------|----------|---------------------------|
| AM11 | F12 | Apartment | \$616.00 | \$656.00 |
| AM12 | F07 | Storeroom | \$609.00 | \$649.00 |
| AM13 | F21 | Front Door | \$616.00 | \$656.00 |
| AM17 | F05 | Classroom | \$609.00 | \$649.00 |
| AM19 | F13 | Dormitory | \$616.00 | \$656.00 |
| AM20 | F20 | Entrance | \$616.00 | \$656.00 |
| AM21 | F08/F10 | Entrance | \$616.00 | \$656.00 |
| AM22 | F04 | Office | \$609.00 | \$649.00 |
| AM23 | - | Vestibule | \$609.00 | \$649.00 |
| AM24 | - | Storeroom | \$609.00 | \$649.00 |
| AM27 | - | Institutional Privacy | \$609.00 | \$649.00 |

Double Cylinder Functions

| Function | ANSI | Description | 26D | 03, 04, 10, 10B, 10BE, 26 |
|----------|------|-------------|----------|---------------------------|
| AM31 | F14 | Storeroom | \$643.00 | \$683.00 |
| AM32 | F09 | Vestibule | \$639.00 | \$679.00 |
| AM33 | - | Storeroom | \$639.00 | \$679.00 |
| AM34 | - | Storeroom | \$643.00 | \$683.00 |
| AM37 | F32 | Classroom | \$639.00 | \$679.00 |

Deadlock Functions (No Trim)

| Function | ANSI | Description | 03, 04, 10, 10B, 10BE, 26, 26D |
|----------|------|----------------------------------|--------------------------------|
| AM40 | F18 | Cylinder One Side | \$432.00 |
| AM41 | F17 | Cylinder x Thumbturn | \$456.00 |
| AM42 | F16 | Double Cylinder | \$480.00 |
| AM44 | - | Classroom - Cylinder x Thumbturn | \$456.00 |

BM Series

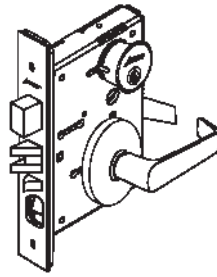

Features

| | |
|---------------------|--|
| Certification | BHMA A156.13, Series 1000, Operationsl Grade 1, UL Listed |
| Door Thickness | 1-3/4" |
| Strike | Standard: ANSI 1-1/4" x 4-7/8", straight lip, with box; curved lip available |
| Latch | 3/4" throw, stainless steel |
| Bolt | 1" throw, stainless steel |
| Backset | 2-3/4" |
| Cylinder | Standard: 6-pin, solid brass, 2 nickel-silver keys; IC prep available |
| Handing | Handed, field reversible without disassembling lock case |
| Case Quantity | 10 |
| Average Case Weight | 62 lbs. |
| Warranty | 5 years |

| Available Finishes | Arrow Code | BHMA Code | U.S. Code |
|--|------------|-----------|-----------|
| Bright brass | 03 | 605 | US3 |
| Satin brass | 04 | 606 | US4 |
| Satin bronze | 10 | 612 | US10 |
| Dark oxidized satin bronze, oil rubbed | 10B | 613 | US10B |
| Dark oxidized satin bronze, equivalent | 10BE | 613E | US10BE |
| Bright chromium plated | 26 | 625 | US26 |
| Satin chromium plated | 26D | 626 | US26D |
| Bright stainless steel | 32 | 629 | US32 |
| Satin stainless steel | 32D | 630 | US32D |

How to Order

| | |
|----------|---------------------------------|
| Function | BM11 |
| Trim | BM11-XL |
| Finish | BM11-XL-26D |
| Strike | BM11-XL-26D-460 |
| Handing | BM11-XL-26D-460-RH |
| Keying | BM11-XL-26D-460-RH-KD-AR |

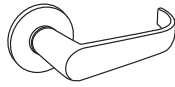

BRL



HSL



NL

Non-Keyed Functions

| Function | ANSI | Description | 26D | 03, 04, 10, 10B, 10BE, 26 | 32, 32D |
|----------|------|--------------|----------|---------------------------|----------|
| BM01 | F01 | Passage | \$449.00 | \$491.00 | \$503.00 |
| BM02 | F19 | Privacy | \$513.00 | \$555.00 | \$567.00 |
| BM07 | - | Exit | \$563.00 | \$584.00 | \$590.00 |
| BM26 | F22 | Privacy | \$513.00 | \$555.00 | \$567.00 |
| BM08 | - | Single Dummy | \$188.00 | \$209.00 | \$215.00 |
| BM09 | - | Full Dummy | \$354.00 | \$396.00 | \$408.00 |

Single Cylinder Functions

| Function | ANSI | Description | 26D | 03, 04, 10, 10B, 10BE, 26 | 32, 32D |
|----------|---------|-----------------------|----------|---------------------------|----------|
| BM11 | F12 | Apartment | \$587.00 | \$629.00 | \$641.00 |
| BM12 | F07 | Storeroom | \$569.00 | \$611.00 | \$623.00 |
| BM13 | F21 | Front Door | \$587.00 | \$629.00 | \$641.00 |
| BM17 | F05 | Classroom | \$569.00 | \$611.00 | \$623.00 |
| BM19 | F13 | Dormitory | \$587.00 | \$629.00 | \$641.00 |
| BM20 | F20 | Entrance | \$587.00 | \$629.00 | \$641.00 |
| BM21 | F08/F10 | Entrance | \$587.00 | \$629.00 | \$641.00 |
| BM22 | F04 | Office | \$569.00 | \$611.00 | \$623.00 |
| BM23 | - | Vestibule | \$569.00 | \$611.00 | \$623.00 |
| BM24 | - | Storeroom | \$569.00 | \$611.00 | \$623.00 |
| BM27 | - | Institutional Privacy | \$569.00 | \$611.00 | \$623.00 |

Double Cylinder Functions

| Function | ANSI | Description | 26D | 03, 04, 10, 10B, 10BE, 26 | 32, 32D |
|----------|------|--------------------|----------|---------------------------|----------|
| BM31 | F14 | Storeroom | \$630.00 | \$672.00 | \$684.00 |
| BM32 | F09 | Vestibule | \$613.00 | \$655.00 | \$667.00 |
| BM33 | - | Storeroom | \$613.00 | \$655.00 | \$667.00 |
| BM34 | - | Storeroom | \$630.00 | \$672.00 | \$684.00 |
| BM37 | F32 | Classroom | \$613.00 | \$655.00 | \$667.00 |
| BM38 | - | Classroom Security | \$695.00 | \$737.00 | \$749.00 |

BM Series Lever Designs

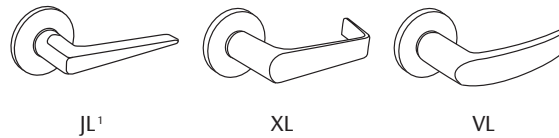

Non-Keyed Functions

| Function | ANSI | Description | 26D | 03, 04, 10, 10B, 10BE, 26 | 32, 32D |
|----------|------|--------------|----------|---------------------------|----------|
| BM01 | F01 | Passage | \$543.00 | \$585.00 | \$597.00 |
| BM02 | F19 | Privacy | \$607.00 | \$649.00 | \$661.00 |
| BM07 | - | Exit | \$610.00 | \$631.00 | \$637.00 |
| BM26 | F22 | Privacy | \$607.00 | \$649.00 | \$661.00 |
| BM08 | - | Single Dummy | \$235.00 | \$256.00 | \$262.00 |
| BM09 | - | Full Dummy | \$448.00 | \$490.00 | \$502.00 |

Single Cylinder Functions

| Function | ANSI | Description | 26D | 03, 04, 10, 10B, 10BE, 26 | 32, 32D |
|----------|---------|-----------------------|----------|---------------------------|----------|
| BM11 | F12 | Apartment | \$681.00 | \$723.00 | \$735.00 |
| BM12 | F07 | Storeroom | \$663.00 | \$705.00 | \$717.00 |
| BM13 | F21 | Front Door | \$681.00 | \$723.00 | \$735.00 |
| BM17 | F05 | Classroom | \$663.00 | \$705.00 | \$717.00 |
| BM19 | F13 | Dormitory | \$681.00 | \$723.00 | \$735.00 |
| BM20 | F20 | Entrance | \$681.00 | \$723.00 | \$735.00 |
| BM21 | F08/F10 | Entrance | \$681.00 | \$723.00 | \$735.00 |
| BM22 | F04 | Office | \$663.00 | \$705.00 | \$717.00 |
| BM23 | - | Vestibule | \$663.00 | \$705.00 | \$717.00 |
| BM24 | - | Storeroom | \$663.00 | \$705.00 | \$717.00 |
| BM27 | - | Institutional Privacy | \$663.00 | \$705.00 | \$717.00 |

Double Cylinder Functions

| Function | ANSI | Description | 26D | 03, 04, 10, 10B, 10BE, 26 | 32, 32D |
|----------|------|--------------------|----------|---------------------------|----------|
| BM31 | F14 | Storeroom | \$724.00 | \$766.00 | \$778.00 |
| BM32 | F09 | Vestibule | \$707.00 | \$749.00 | \$761.00 |
| BM33 | - | Storeroom | \$707.00 | \$749.00 | \$761.00 |
| BM34 | - | Storeroom | \$724.00 | \$766.00 | \$778.00 |
| BM37 | F32 | Classroom | \$707.00 | \$749.00 | \$761.00 |
| BM38 | - | Classroom Security | \$789.00 | \$831.00 | \$843.00 |

¹ JL trim design not available in 32 or 32D finish.

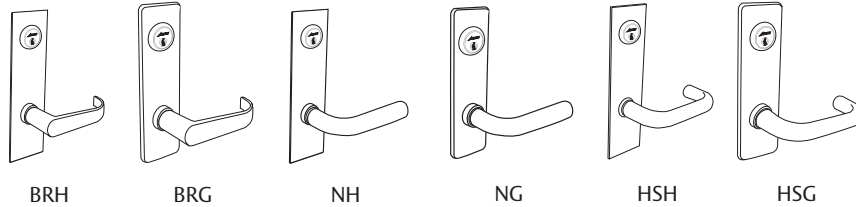

BM Series Lever Designs

Non-Keyed Functions

| Function | ANSI | Description | 26D | 03, 04, 10, 10B, 10BE, 26 | 32, 32D |
|----------|------|--------------|----------|---------------------------|----------|
| BM01 | F01 | Passage | \$493.00 | \$535.00 | \$547.00 |
| BM02 | F19 | Privacy | \$557.00 | \$599.00 | \$611.00 |
| BM07 | - | Exit | \$585.00 | \$606.00 | \$612.00 |
| BM26 | F22 | Privacy | \$557.00 | \$599.00 | \$611.00 |
| BM08 | - | Single Dummy | \$210.00 | \$231.00 | \$237.00 |
| BM09 | - | Full Dummy | \$398.00 | \$440.00 | \$452.00 |

Single Cylinder Functions

| Function | ANSI | Description | 26D | 03, 04, 10, 10B, 10BE, 26 | 32, 32D |
|----------|---------|-----------------------|----------|---------------------------|----------|
| BM11 | F12 | Apartment | \$631.00 | \$673.00 | \$685.00 |
| BM12 | F07 | Storeroom | \$613.00 | \$655.00 | \$667.00 |
| BM13 | F21 | Front Door | \$631.00 | \$673.00 | \$685.00 |
| BM17 | F05 | Classroom | \$613.00 | \$655.00 | \$667.00 |
| BM19 | F13 | Dormitory | \$631.00 | \$673.00 | \$685.00 |
| BM20 | F20 | Entrance | \$631.00 | \$673.00 | \$685.00 |
| BM21 | F08/F10 | Entrance | \$631.00 | \$673.00 | \$685.00 |
| BM22 | F04 | Office | \$613.00 | \$655.00 | \$667.00 |
| BM23 | - | Vestibule | \$613.00 | \$655.00 | \$667.00 |
| BM24 | - | Storeroom | \$613.00 | \$655.00 | \$667.00 |
| BM27 | - | Institutional Privacy | \$613.00 | \$655.00 | \$667.00 |

Double Cylinder Functions

| Function | ANSI | Description | 26D | 03, 04, 10, 10B, 10BE, 26 | 32, 32D |
|----------|------|--------------------|----------|---------------------------|----------|
| BM31 | F14 | Storeroom | \$674.00 | \$716.00 | \$728.00 |
| BM32 | F09 | Vestibule | \$657.00 | \$699.00 | \$711.00 |
| BM33 | - | Storeroom | \$657.00 | \$699.00 | \$711.00 |
| BM34 | - | Storeroom | \$674.00 | \$716.00 | \$728.00 |
| BM37 | F32 | Classroom | \$657.00 | \$699.00 | \$711.00 |
| BM38 | - | Classroom Security | \$739.00 | \$781.00 | \$793.00 |

BM Series Lever Designs

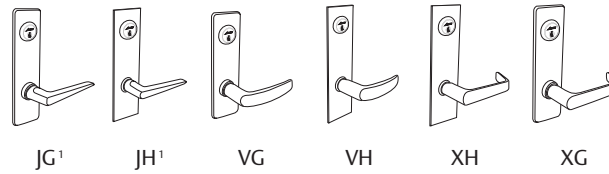

Non-Keyed Functions

| Function | ANSI | Description | 26D | 03, 04, 10, 10B, 10BE, 26 | 32, 32D |
|----------|------|--------------|----------|---------------------------|----------|
| BM01 | F01 | Passage | \$587.00 | \$629.00 | \$641.00 |
| BM02 | F19 | Privacy | \$651.00 | \$693.00 | \$705.00 |
| BM07 | - | Exit | \$632.00 | \$653.00 | \$659.00 |
| BM26 | F22 | Privacy | \$651.00 | \$693.00 | \$705.00 |
| BM08 | - | Single Dummy | \$257.00 | \$278.00 | \$284.00 |
| BM09 | - | Full Dummy | \$492.00 | \$534.00 | \$546.00 |

Single Cylinder Functions

| Function | ANSI | Description | 26D | 03, 04, 10, 10B, 10BE, 26 | 32, 32D |
|----------|---------|-----------------------|----------|---------------------------|----------|
| BM11 | F12 | Apartment | \$725.00 | \$767.00 | \$779.00 |
| BM12 | F07 | Storeroom | \$707.00 | \$749.00 | \$761.00 |
| BM13 | F21 | Front Door | \$725.00 | \$767.00 | \$779.00 |
| BM17 | F05 | Classroom | \$707.00 | \$749.00 | \$761.00 |
| BM19 | F13 | Dormitory | \$725.00 | \$767.00 | \$779.00 |
| BM20 | F20 | Entrance | \$725.00 | \$767.00 | \$779.00 |
| BM21 | F08/F10 | Entrance | \$725.00 | \$767.00 | \$779.00 |
| BM22 | F04 | Office | \$707.00 | \$749.00 | \$761.00 |
| BM23 | - | Vestibule | \$707.00 | \$749.00 | \$761.00 |
| BM24 | - | Storeroom | \$707.00 | \$749.00 | \$761.00 |
| BM27 | - | Institutional Privacy | \$707.00 | \$749.00 | \$761.00 |

Double Cylinder Functions

| Function | ANSI | Description | 26D | 03, 04, 10, 10B, 10BE, 26 | 32, 32D |
|----------|------|--------------------|----------|---------------------------|----------|
| BM31 | F14 | Storeroom | \$768.00 | \$810.00 | \$822.00 |
| BM32 | F09 | Vestibule | \$751.00 | \$793.00 | \$805.00 |
| BM33 | - | Storeroom | \$751.00 | \$793.00 | \$805.00 |
| BM34 | - | Storeroom | \$768.00 | \$810.00 | \$822.00 |
| BM37 | F32 | Classroom | \$751.00 | \$793.00 | \$805.00 |
| BM38 | - | Classroom Security | \$833.00 | \$875.00 | \$887.00 |

¹ JH & JG trim designs not available in 32 or 32D finish.

AM & BM Series Options

| Strike Options | Lock Function | Specify | Price Add |
|----------------|--|------------------------------|-----------|
| Straight lip | 02, 11, 13, 19, 20, 21, 31, 34, 38 | 460 | Standard |
| Straight lip | 01, 07, 12, 17, 22, 23, 24, 26, 27, 32, 33, 37 | 463 | Standard |
| Straight lip | 40, 41, 42, 44 | 456 | Standard |
| Curved lip | Optional strike for 01, 07, 12, 17, 22, 23, 24, 26, 27, 32, 33, 37 | 462 (LH, RR) 464 (RH, LR) | No Add |
| Curved lip | Optional strike for 02, 11, 13, 19, 20, 21, 31, 34 | 466 (LH, RR) 468 (RH, LR) | No Add |

Note: Straight Lip Strike = 1-1/8" Lip-to-Center
Curved Lip Strike = 1-1/4" Lip-to-Center

| Keying & Cylinder Options | Specify | Price Add |
|--|---------|----------------------|
| Keyed different | KD | Standard |
| Master keyed | MK | \$13.00 per cylinder |
| Construction master keyed | CMK | \$8.16 per cylinder |
| Master keyed & construction master keyed | MK-CMK | \$21.16 per cylinder |
| O-Bitted | OB | No Add |
| Less cylinder | LC | -\$13.35 |
| Lock prepared to accept 6-pin IC cylinder, less core | IC6 | No Add |
| Lock prepared to accept 7-pin IC cylinder, less core | IC7 | No Add |

| Miscellaneous Options | Specify | Price Add |
|-------------------------------------|------------------|-----------|
| Abrasive outside lever (BM Series) | 113 | \$58.40 |
| Abrasive inside lever (BM Series) | 114 | \$58.40 |
| Knurled outside lever (BM Series) | 103 | \$82.30 |
| Knurled inside lever (BM Series) | 104 | \$82.30 |
| Lead lined case | 123 | \$139.00 |
| Lead lined knobs (inside & outside) | 127 | \$277.00 |
| Lead lined roses (inside & outside) | 133 | \$208.00 |
| Rabbeted front and strike | 144 | \$106.00 |
| Hold back latch for 12 function | HB | \$56.65 |
| Security Head Screws | SHS ² | \$14.43 |

²Only available for locks in 26, 26D, 32, or 32D finish. Not available for T Knob, B Knob, or any escutcheon design.

NOTE: Arrow mortise locks are designed for standard 1-3/4" door applications. See *Non-Cataloged Products* in the *Terms & Conditions of Sale* section for additional details.

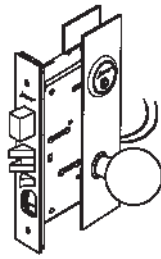

AM Series

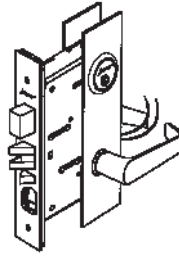

BM Series

AM & BM Series Options

Electrification Options (extended lead time required)

| Description | Voltage | Specify | Price Add ¹ |
|---|-----------|-----------------|------------------------|
| Fail-safe trim control (applied to 17 function) | 12V AC/DC | 177 | \$472.00 |
| | 24V AC/DC | 179 | \$472.00 |
| Fail-secure trim control (applied to 17 function) | 12V AC/DC | 181 | \$472.00 |
| | 24V AC/DC | 183 | \$472.00 |
| Latchbolt monitoring | | LM ² | \$273.00 |
| Request to exit - authorized | | RE | \$273.00 |
| Security monitoring | | SM ² | \$515.00 |

¹ Electrification charges do not include price of locksets.

² LM and SM options cannot be combined.

Fail-safe Power on locks outside lever
 Inside lever always free
 Latch retracted by keys when locked electrically

Fail-secure Power off locks outside lever
 Inside lever always free
 Latch retracted by keys when locked electrically

Latchbolt monitoring
 Full extension of the latch monitored by a SPDT switch

Request to exit - authorized egress
 Inside trim monitored by an SPTD switch. Switch can be used to shunt a door alarm to allow egress, signal a control console when the trim is activated, or activate a door alarm.

Security monitoring
 Monitors, in series, solenoid status (locked or unlocked) and latch status (deadlatch position).

Specifications 12VAC/VDC @ 612mA
 24VAC/VDC @ 330mA

| Strikes | Lock Function | Specify Finish | Part No. | Price |
|--------------|--|----------------|--------------|---------|
| Straight lip | 02, 11, 13, 19, 20, 21, 31, 34, 38 | • | 460 | \$33.36 |
| Straight lip | 01, 07, 12, 17, 22, 23, 24, 26, 27, 32, 33, 37 | • | 463 | \$33.36 |
| Straight lip | 40, 41, 42, 44 | • | 456 | \$33.36 |
| Curved lip | 01, 07, 12, 17, 22, 23, 24, 26, 27, 32, 33, 37 | • | 462 (LH, RR) | \$33.36 |
| | | | 464 (RH, LR) | |
| Curved lip | 02, 11, 13, 19, 20, 21, 31, 34, 38 | • | 466 (LH, RR) | \$33.36 |
| | | | 468 (RH, LR) | |
| Box Strike | For all strikes above | | BX70 | \$5.08 |

| Cylinders & Related | Specify Finish | Part No. | Price |
|--|--|-------------|---------|
| Standard mortise cylinder | • | MC61-001 | \$40.12 |
| | | MC61-AM2 | \$40.12 |
| Emergency key for privacy function | | 16L-207 | \$1.84 |
| Cylinder cams | For functions 12, 17, 22, 23, 24, 27, 32 (I/S), 33, 37 | 001 | \$3.47 |
| | For functions 11, 13, 19, 20, 21, 31, 32 (O/S), 34, 38, 40, 41, 42, 44 | AM2 | \$3.47 |
| Cylinder collar & spring | • | 16-113A | \$9.24 |
| Mortise housing to accept 6-pin IC cylinder, less core | • | 16CR-16X001 | \$39.34 |
| | | 16CR-16XAM2 | \$39.34 |
| Mortise housing to accept 7-pin IC cylinder, less core | • | 16CR-27X001 | \$39.34 |
| | | 16CR-27XAM2 | \$39.34 |
| Housing cams | For functions 12, 17, 22, 23, 24, 27, 32 (I/S), 33, 37 | 16CR-001 | \$3.47 |
| | For functions 11, 13, 19, 20, 21, 31, 32 (O/S), 34, 38, 40, 41, 42, 44 | 16CR-AM2 | \$3.47 |

Parts & Accessories

| Description | Lock Function | Specify Finish | Part No. | Price |
|---|----------------------------|---------------------------|----------|---------|
| Faceplates | 01, 24, 26 | • | AM01-305 | \$30.03 |
| | 02, 13, 19, 31 | • | AM02-305 | \$30.03 |
| | 07, 12, 17, 27, 32, 33, 37 | • | AM12-305 | \$30.03 |
| | 11, 21, 34 | • | AM11-305 | \$30.03 |
| | 38 | • | AM15-305 | \$30.03 |
| | 20 | • | AM20-305 | \$30.03 |
| | 22 | • | AM22-305 | \$30.03 |
| | 23 | • | AM23-305 | \$30.03 |
| | 40, 41, 42, 44 | • | AM41-305 | \$30.03 |
| | Spindles | AM trim with H escutcheon | | AM-385A |
| AM trim with G escutcheon or rose trim | | | AM-386A | \$23.45 |
| BM trim with H escutcheon or rose trim | | | BM-385A | \$20.07 |
| BM trim with G escutcheon | | | BM-386A | \$23.45 |
| Thumbturn for sectional trim | | • | 16-17A | \$21.76 |
| Emergency rose for privacy function with sectional trim | | • | 16-04A | \$10.09 |
| Emergency key for privacy function | | | 16L-207 | \$1.84 |
| BM Series rose | | | 17-03-2 | \$32.52 |
| Stud for mounting plate | | | BM-94 | \$0.89 |
| Mounting plate for lever x rose trim | | | BM-93A | \$9.24 |
| Standard screw pack | | • | AM-201 | \$2.60 |
| Supplement screw pack for G escutcheon | | • | AM-201G | \$0.99 |
| Supplement screw pack for H escutcheon | | • | AM-201H | \$0.99 |
| Faceplate screw | | | 16-306 | \$0.39 |
| Black nylon bushing insert | | | 16-14 | \$0.84 |
| Lever handle set screw | | | 17-388 | \$0.89 |

AM & BM Series Lockbodies



| Lockbodies | Lock Function (specify handing - RH, LH, RR, or LR) | Part No. | Price |
|-------------------------|---|----------|----------|
| | 01 | AM01-LB | \$213.00 |
| | 02, 19 | AM02-LB | \$295.00 |
| | 07, 12 | AM12-LB | \$282.00 |
| | 11 | AM11-LB | \$295.00 |
| | 13, 31 | AM13-LB | \$295.00 |
| | 17, 32, 37 | AM17-LB | \$282.00 |
| For AM knobs | 20 | AM20-LB | \$295.00 |
| | 21, 34 | AM21-LB | \$295.00 |
| | 22 | AM22-LB | \$282.00 |
| | 23 | AM23-LB | \$282.00 |
| | 24 | AM24-LB | \$282.00 |
| | 26 | AM26-LB | \$282.00 |
| | 27 | AM27-LB | \$282.00 |
| | 33 | AM33-LB | \$282.00 |
| For deadlocks less trim | 40, 41, 42 | AM41-LB | \$272.00 |
| | 44 | AM44-LB | \$272.00 |
| | 01 | BM01-LB | \$213.00 |
| | 02, 19 | BM02-LB | \$295.00 |
| | 07, 12 | BM12-LB | \$282.00 |
| | 11 | BM11-LB | \$295.00 |
| | 13, 31 | BM13-LB | \$295.00 |
| | 17, 32, 37 | BM17-LB | \$282.00 |
| For BM levers | 20 | BM20-LB | \$295.00 |
| | 21, 34 | BM21-LB | \$295.00 |
| | 22 | BM22-LB | \$282.00 |
| | 23 | BM23-LB | \$282.00 |
| | 24 | BM24-LB | \$282.00 |
| | 26 | BM26-LB | \$282.00 |
| | 27 | BM27-LB | \$282.00 |
| | 33 | BM33-LB | \$282.00 |
| | 38 | BM38-LB | \$321.00 |

• Faceplates and screwpacks are not included with lockbodies.

AM & BM Series Trim Packs

AM Knob Trims

| Trim Design | Lock Function | Suffix No. | 26D | 03, 04, 10, 10B, 10BE, 26 |
|-------------------|--|------------|----------|---------------------------|
| TA, BD | 01, 12, 17, 22, 23, 24, 31, 32, 33, 34, 37 | 4 | \$218.00 | \$223.00 |
| | 11, 13, 19, 20, 21, 27 | 6 | \$240.00 | \$245.00 |
| | 02, 26 | 7 | \$250.00 | \$255.00 |
| BG, BH, TG, TH | 01 | 3 | \$228.00 | \$233.00 |
| | 12, 17, 22, 23, 24 | 4 | \$228.00 | \$233.00 |
| | 31, 32, 33, 34, 37 | 5 | \$228.00 | \$233.00 |
| | 11, 13, 19, 20, 21, 27 | 6 | \$250.00 | \$255.00 |
| | 02, 26 | 7 | \$260.00 | \$265.00 |

BM Lever Trims

| Trim Design | Lock Function | Suffix No. | 26D | 03, 04, 10, 10B, 10BE, 26 | 32, 32D |
|---|--|------------|----------|---------------------------|----------|
| BRL, HSL, NL | 01, 12, 17, 22, 23, 24, 31, 32, 33, 34, 37, 38 | 4 | \$265.00 | \$288.00 | \$305.00 |
| | 11, 13, 19, 20, 21, 27 | 6 | \$288.00 | \$312.00 | \$328.00 |
| | 02, 26 | 7 | \$298.00 | \$320.00 | \$336.00 |
| JL ¹ , VL, XL | 01, 12, 17, 22, 23, 24, 31, 32, 33, 34, 37, 38 | 4 | \$328.00 | \$350.00 | \$368.00 |
| | 11, 13, 19, 20, 21, 27 | 6 | \$350.00 | \$368.00 | \$388.00 |
| | 02, 26 | 7 | \$361.00 | \$380.00 | \$398.00 |
| BRG, BRH, NG, NH, HSG, HSH | 01 | 3 | \$282.00 | \$305.00 | \$320.00 |
| | 12, 17, 22, 23, 24 | 4 | \$282.00 | \$305.00 | \$320.00 |
| | 31, 32, 33, 34, 37, 38 | 5 | \$282.00 | \$305.00 | \$320.00 |
| | 11, 13, 19, 20, 21, 27 | 6 | \$305.00 | \$328.00 | \$343.00 |
| | 02, 26 | 7 | \$315.00 | \$336.00 | \$355.00 |
| JG ¹ , JH ¹ , VG, VH, XG, XH | 01 | 3 | \$350.00 | \$368.00 | \$385.00 |
| | 12, 17, 22, 23, 24 | 4 | \$350.00 | \$368.00 | \$385.00 |
| | 31, 32, 33, 34, 37, 38 | 5 | \$350.00 | \$368.00 | \$385.00 |
| | 11, 13, 19, 20, 21, 27 | 6 | \$368.00 | \$391.00 | \$406.00 |
| | 02, 26 | 7 | \$380.00 | \$401.00 | \$416.00 |

- Example - Trim for an "01" function: TA4 or BRL4 (specify finish).
- Trim packs are supplied less cylinder. Each pack includes inside & outside trims, spindle, turnpiece (where applicable), & mounting screws.

¹JL, JG, & JH trim designs not available in 32 or 32D finish.

QL Series

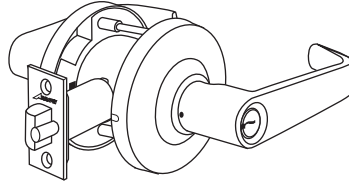
Features

| | |
|---------------------------|--|
| Certification | BHMA A156.2, Series 4000, Grade 1, UL Listed |
| Freewheeling Lever Action | Standard |
| Door Thickness | Fits 1-3/8" to 1-3/4", factory set for 1-3/4" |
| Strike | ANSI 1-1/4" x 4-7/8" |
| Latch | 2-3/4" backset, 1-1/8" front |
| Cylinder | Standard 6 Pin, solid brass, 2 nickel-plated brass keys, IC prep available |
| Handing | Non-handed |
| Case Quantity | 6 per case |
| Average Case Weight | 27 lbs. |
| Warranty | 10 years |

| Available Finishes | Arrow Code | BHMA Code | U.S. Code |
|--|------------|-----------|-----------|
| Bright Brass | 03 | 605 | US3 |
| Dark Oxidized Satin Bronze, equivalent | 613E | 613E | US10BE |
| Satin Chromium Plated | 26D | 626 | US26D |

How to Order

| | |
|-----------------|---------------------------------|
| Function & Trim | QL81-SB |
| Finish | QL81-SB-26D |
| Strike | QL81-SB-26D-306 |
| Latch | QL81-SB-26D-306-Q71 |
| Keying | QL81-SB-26D-306-Q71-ARKD |

| Function | Description | 03, 613E, 26D |
|----------|--------------------|---------------|
| QL01-SB | Passage | \$197.00 |
| QL72-SB | Privacy | \$229.00 |
| QL81-SB | Entrance | \$256.00 |
| QL82-SB | Storeroom | \$256.00 |
| QL87-SB | Classroom | \$256.00 |
| QL97-SB | Classroom Intruder | \$319.00 |

| *** AVAILABLE THROUGH SELECT DISTRIBUTORS – CONTACT ARROW LOCK FOR MORE INFORMATION *** | | |
|---|--------------------|---------------|
| Rigid Lever Function | Description | 03, 613E, 26D |
| QL02-SB | Privacy | \$229.00 |
| QL11-SB | Entrance | \$256.00 |
| QL12-SB | Storeroom | \$256.00 |
| QL17-SB | Classroom | \$256.00 |
| QL33-SB | Asylum | \$293.00 |
| QL37-SB | Classroom Intruder | \$319.00 |
| Freewheeling Function | Description | 03, 613E, 26D |
| QL93-SB | Asylum | \$293.00 |

Specify SR trim for QL design with removable thru-bolts.

QL Series

Options & Parts

| Keying & Cylinder Options | Specify | Price Add |
|--|------------------|-----------|
| Keyed different, AR keyway | ARKD | Standard |
| Keyed different, CS keyway | CSKD | No Add |
| Lock prepared to accept a 6- or 7-pin SFIC cylinder (not included) | IC | No Add |
| Lock prepared to accept Schlage LFIC cylinder (not included) | SIC ¹ | \$25.00 |
| Lock prepared to accept a Medeco 320201 or ASSA LFIC cylinder (not included) | LIC | \$25.00 |

¹ Not available with 10BP finish, 03 finish, or the QL97 function.

| Latch Options | Spring Latch | Dead Latch | Price Add |
|-------------------------------|--------------|------------|-----------|
| 2-3/4" backset x 1-1/8" front | Q73 | Q71 | Standard |

| Parts | Part No. | Price |
|---|--|---------|
| Standard cylinder with tailpiece – AR keyway | C700HD | \$25.75 |
| Standard cylinder with tailpiece – CS keyway | C700HD-CS | \$25.75 |
| Strike | 306 | \$26.71 |
| Latch - 2-3/4" backset | Q73 ² or Q71 ³ | \$21.29 |
| Latch - 2-3/8" backset (sold only as a separate part) | R22 ^{2,4} or R20 ^{3,4} | \$15.59 |
| Screw pack | QL-201 | \$1.89 |
| Standard cylinder tailpiece | 1001SC-44 | \$2.60 |
| Standard cylinder screw cap | SC-01 | \$8.48 |
| Standard cylinder cap pin | SC-02 | \$3.06 |
| Standard cylinder cap spring | SC-03 | \$0.95 |
| IC tailpiece kit (tailpiece & spacer for 6- & 7- pin cores) | RLX-44-201 | \$5.03 |
| SIC Tailpiece | QL-44S | \$14.06 |
| LIC tailpiece | QL-44 | \$3.17 |
| LIC tailpiece retainer | QL-66 | \$0.44 |
| Alternate classroom intruder rose with red arrows | QL97-03A.26D | \$32.45 |

¹ Not available with 10BP finish, 03 finish, or QL97 function.

² Used only with non-keyed functions.

³ Used only with keyed functions.

⁴ Sold only as a separate part. Not tested to grade 1 specifications. If substituted for standard latch, grade 1 rating is voided.

GL Series

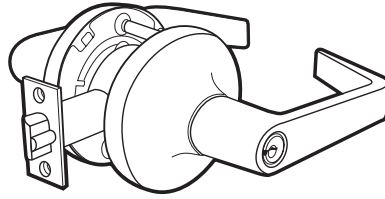

Features

| | |
|---------------------|---|
| Certification | BHMA A156.2, Series 4000, Grade 1, UL Listed |
| Door Thickness | Fits 1-3/4" - 2", factory set for 1-3/4" |
| Strike | ANSI 1-1/4" x 4-7/8" |
| Latch | 2-3/4" backset, 1-1/8" front |
| Cylinder | Standard: 6-pin, solid brass, 2 brass keys; IC prep available |
| Handing | Non-handed |
| Case Quantity | 6 |
| Average Case Weight | 31 lbs. |
| Warranty | 5 years |

| Available Finishes | Arrow Code | BHMA Code | U.S. Code |
|--|------------|-----------|-----------|
| Bright Brass | 03 | 605 | US3 |
| Dark Oxidized Satin Bronze, Oil Rubbed | 10B | 613 | US10B |
| Satin Chromium Plated | 26D | 626 | US26D |

How to Order

| | |
|-----------------|----------------------------------|
| Function & Trim | GL81-SR |
| Finish | GL81-SR-26D |
| Strike | GL81-SR-26D-306 |
| Latch | GL81-SR-26D-306-G71 |
| Keying | GL81-SR-26D-306-G71-KD-AR |

| Function | ANSI | Description | 03, 26D | 10B |
|----------|------|--------------------|----------|----------|
| GL01-SR | F75 | Passage | \$210.00 | \$226.00 |
| GL02-SR | F76 | Privacy | \$245.00 | \$261.00 |
| GL08-SR | - | Single Dummy | \$112.00 | \$120.00 |
| GL81-SR | F109 | Entrance | \$272.00 | \$288.00 |
| GL82-SR | F86 | Storeroom | \$272.00 | \$288.00 |
| GL87-SR | F84 | Classroom | \$272.00 | \$288.00 |
| GL97-SR | F110 | Classroom Intruder | \$342.00 | \$358.00 |

GL Series Options & Parts

| Strike & Latch Options | Specify | Price Add |
|--|---------|-----------|
| ANSI Strike | 306 | Standard |
| Latch (keyed functions) - 2-3/4" backset, 1-1/8" front | G71 | Standard |
| Latch (non-keyed functions) - 2-3/4" backset, 1-1/8" front | G73 | Standard |

| Keying & Cylinder Options | Specify | Price Add |
|---|---------|----------------------|
| Keyed different | KD | Standard |
| Master keyed | MK | \$13.00 per cylinder |
| Construction master keyed | CMK | \$8.16 per cylinder |
| Master keyed & construction master keyed | MK-CMK | \$21.16 per cylinder |
| Keyed alike | KA | No Add |
| O-Bitted | OB | No Add |
| Less cylinder | LC | -\$8.55 |
| Lock prepared to accept 6 or 7-pin SFIC cylinder, less core | IC | No Add |

*LC option no longer available for this product. Please refer to the QL Series.

| Parts | Part No. | Price |
|---|-----------|---------|
| ANSI Strike | 306 | \$26.71 |
| Standard dead latch (for keyed functions) | G71 | \$21.29 |
| Standard spring latch (for passage & privacy functions) | G73 | \$21.29 |
| Standard cylinder w/tailpiece | 600HD-GL | \$25.75 |
| Standard keyblank | K6A | \$1.29 |
| Standard tailpiece | 1001GL-44 | \$2.60 |

Alternate Latches (sold only as separate parts)

| Backset | Description | Specify >>> | Spring Latch | Dead Latch | Price |
|----------------|--------------|-------------|--------------|------------|---------|
| 2-3/8" Backset | 1" front | | G72 | G70 | \$21.29 |
| 3-3/4" Backset | 1-1/8" front | | G83 | G81 | \$27.15 |
| 5" Backset | 1-1/8" front | | G93 | G91 | \$31.66 |

HK Series

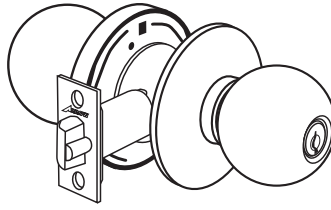

Features

| | |
|---------------------|--|
| Certification | BHMA A156.2, Series 4000, Grade 1, UL Listed |
| Door Thickness | Fits 1-3/8" to 2" factory set to 1-3/4" |
| Strike | ANSI 1-1/4" x 4-7/8" |
| Latch | 2-3/4" backset, 1-1/8" front |
| Cylinder | Standard 6 Pin, solid brass, 2 nickel-plated brass keys, IC prep available |
| Handing | Non-handed |
| Case Quantity | 16 |
| Average Case Weight | 32 lbs. |
| Warranty | 10 years |

| Available Finishes | Arrow Code | BHMA Code | U.S. Code |
|---------------------------------------|------------|-----------|-----------|
| Bright Brass | 605 | 605 | US3 |
| Dark Oxide Satin Bronze, clear coated | 10BP | 614 | US10BL |
| Satin Stainless Steel | 630 | 630 | US32D |

How to Order

| | |
|-----------------|---------------------------------|
| Function & Trim | HK11-BB |
| Finish | HK11-BB-630 |
| Strike | HK11-BB-630-306 |
| Latch | HK11-BB-630-306-Q71 |
| Keying | HK11-BB-630-306-Q71-ARKD |

| Function | Description | 10BP, 605, 630 |
|----------|--------------|----------------|
| HK01-BB | Passage | \$208.00 |
| HK02-BB | Privacy | \$252.00 |
| HK08-BB | Single Dummy | \$124.00 |
| HK11-BB | Entrance | \$296.00 |
| HK12-BB | Storeroom | \$296.00 |
| HK17-BB | Classroom | \$296.00 |
| HK33-BB | Asylum | \$324.00 |

| Keying & Cylinder Options | Specify | Price Add |
|--|---------|-----------|
| Keyed different, AR keyway | ARKD | Standard |
| Keyed different, CS keyway | CSKD | No Add |
| Lock prepared to accept a 6- or 7-pin SFIC cylinder (not included) | IC | No Add |

| Latch Options | Spring Latch | Dead Latch | Price Add |
|-------------------------------|--------------|------------|-----------|
| 2-3/4" backset x 1-1/8" front | Q73 | Q71 | Standard |

HK Series Parts

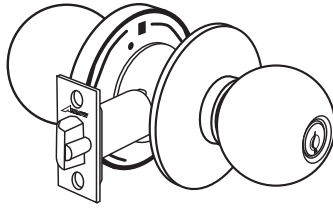

| Parts | Part No. | Price |
|--|--|---------|
| Standard cylinder with tailpiece – AR keyway | C700HD | \$25.75 |
| Standard cylinder with tailpiece – CS keyway | C700HD-CS | \$25.75 |
| Strike | 306 | \$26.71 |
| Latch - 2-3/4" backset | Q73 ¹ or Q71 ² | \$21.29 |
| Latch - 2-3/8" backset (sold only as a separate part) | R22 ^{1,3} or R20 ^{2,3} | \$15.59 |
| Screw pack | HK-201 | \$5.03 |
| Standard cylinder tailpiece | 1001SC-44 | \$2.60 |
| Standard cylinder screw cap | SC-01 | \$8.48 |
| Standard cylinder cap pin | SC-02 | \$3.06 |
| Standard cylinder cap spring | SC-03 | \$0.95 |
| IC tailpiece kit (tailpiece & spacer for 6- & 7-pin cores) | HK-44-201 | \$5.03 |

¹ Used only with non-keyed functions.

² Used only with keyed functions.

³ Sold only as a separate part. Not tested to grade 1 specifications. If substituted for standard latch, grade 1 rating is voided.

MK Series

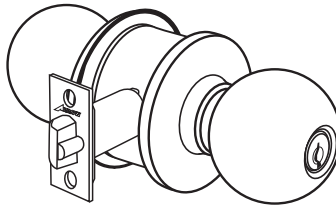

Features

| | |
|---------------------|--|
| Certification | BHMA A156.2, Series 4000, Grade 2, UL Listed |
| Door Thickness | Fits 1-3/8" - 1-3/4", factory set for 1-3/4" |
| Strike | Standard: T-strike, 1-1/8" x 2-3/4"; alternate strikes available |
| Latch | Standard: 2-3/4" backset, 1-1/8" front; alternate latches available |
| Cylinder | Standard: 6-pin, keyed 5, solid brass, 2 brass keys; IC prep available |
| Handing | Non-handed |
| Case Quantity | 12 |
| Average Case Weight | 21 lbs. |
| Warranty | 1 year |

| Available Finishes | Arrow Code | BHMA Code | U.S. Code |
|--|------------|-----------|-----------|
| Bright brass | 03 | 605 | US3 |
| Satin brass | 04 | 606 | US4 |
| Antique brass | 05A | 609 | US5 |
| Satin bronze | 10 | 612 | US10 |
| Dark oxidized satin bronze, oil rubbed | 10B | 613 | US10B |
| Dark oxidized satin bronze, equivalent | 10BE | 613E | US10BE |
| Satin nickel | 15 | 619 | US15 |
| Bright chromium plated | 26 | 625 | US26 |
| Satin chromium plated | 26D | 626 | US26D |

How to Order

| | |
|----------|----------------------------------|
| Function | MK11 |
| Trim | MK11-TA |
| Finish | MK11-TA-26D |
| Strike | MK11-TA-26D-300 |
| Latch | MK11-TA-26D-300-114 |
| Keying | MK11-TA-26D-300-114-KD-AR |

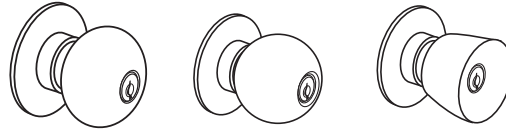

TA

BD¹

DD¹

Non-Keyed Functions

| Function | ANSI | Description | 03, 26D | 04, 05A, 10, 10B, 10BE, 15, 26 |
|----------|------|-----------------------|----------|--------------------------------|
| MK01 | F75 | Passage | \$80.00 | \$90.00 |
| MK02 | F76 | Privacy | \$85.00 | \$95.00 |
| MK03 | F111 | Communicating Passage | \$80.00 | \$85.00 |
| MK04 | F77 | Patio | \$86.00 | \$96.00 |
| MK05 | F78 | Communicating | \$117.00 | \$127.00 |
| MK08 | - | Single Dummy | \$57.00 | \$62.00 |

Single Cylinder Functions

| Function | ANSI | Description | 03, 26D | 04, 05A, 10, 10B, 10BE, 15, 26 |
|----------|------------------|-------------------------|----------|--------------------------------|
| MK11 | F109 (F81 & F82) | Entrance/Office | \$120.00 | \$130.00 |
| MK12 | F86 | Storeroom | \$120.00 | \$130.00 |
| MK13 | F82 | Exterior | \$120.00 | \$130.00 |
| MK14 | F92 | Service Station | \$136.00 | \$146.00 |
| MK15¹ | F93 | Hotel | \$190.00 | \$200.00 |
| MK17 | F84 | Classroom | \$136.00 | \$146.00 |
| MK18 | F113 | Communicating Classroom | \$120.00 | \$125.00 |

Double Cylinder Functions

| Function | ANSI | Description | 03, 26D | 04, 05A, 10, 10B, 10BE, 15, 26 |
|----------|------|-----------------|----------|--------------------------------|
| MK31 | F80 | Communicating | \$206.00 | \$216.00 |
| MK32 | F88 | Public Entrance | \$206.00 | \$216.00 |
| MK33 | F87 | Asylum | \$206.00 | \$216.00 |
| MK34 | - | Exterior | \$206.00 | \$216.00 |

| Prices below include: "TA" trim prepared for IC cylinder(s), ANSI strike, & UL latch | |
|--|--------------------------------|
| 03, 26D | 04, 05A, 10, 10B, 10BE, 15, 26 |
| \$183.10 | \$193.10 |
| \$183.10 | \$193.10 |
| \$183.10 | \$193.10 |
| \$199.10 | \$209.10 |
| - | - |
| \$199.10 | \$209.10 |
| \$183.10 | \$188.10 |
| 03, 26D | 04, 05A, 10, 10B, 10BE, 15, 26 |
| \$269.10 | \$209.10 |
| \$269.10 | \$209.10 |
| \$269.10 | \$209.10 |
| \$269.10 | \$209.10 |

Cylindrical Locks

¹ Not available with IC option.

MK Series Options

| Strike Options | Description | Specify | Price Add |
|-------------------|--|------------------|-----------|
| T-Strike | 1-1/8" x 2-3/4", 1-1/4" lip, square corner, no box | 300 | Standard |
| ANSI ¹ | 1-1/4" x 4-7/8", 1-1/4" lip, square corner, no box | 306 ¹ | \$18.23 |
| Full Lip D-Type | 1-3/4" x 2-1/4", 1-1/4" lip, square corner | 302 | No Add |
| Radius D-Type | 1-3/4" x 2-1/4", 1-1/4" lip, 1/4" radius corner | 303 | No Add |
| Box Strike | Supplied when specified | WBS | No Add |

| Latch Options | Description | Specify >>> | Spring Latch | Dead Latch | Price Add |
|----------------|--|-------------|------------------|------------------|-----------|
| 2-3/4" Backset | 1-1/8", square corner | | 104 | 114 | Standard |
| | 1-1/8", square corner, UL ¹ | | 224 ¹ | 124 ¹ | \$19.87 |
| | 1", square corner | | 102 | 112 | \$4.37 |
| | 1", square corner, UL | | 222 | 122 | \$19.87 |
| | Drive-in | | - | 116 | \$6.57 |
| 2-3/8" Backset | 1", square corner | | 101 | 111 | No Add |
| | 1", square corner, UL | | 221 | 121 | \$19.87 |
| | 1", round corner | | 109 | - | \$4.37 |
| | Drive-in | | - | 115 | \$6.57 |
| Less Latch | | | LAT | | -\$3.90 |

| Keying & Cylinder Options | Specify | Price Add |
|--|-----------------|----------------------|
| Keyed alike in four (quantity permitting otherwise KD) | KA4 | Standard |
| Keyed different | KD | No Add |
| Master keyed | MK | \$13.00 per cylinder |
| Construction master keyed | CMK | \$8.16 per cylinder |
| Master keyed & construction master keyed | MK-CMK | \$21.16 per cylinder |
| O-Bitted | OB | No Add |
| Less Cylinder | LC | -\$8.55 |
| TA design prepared to accept 6 or 7-pin SFIC cylinder, less core | IC ¹ | \$25.00 |

¹ Unless otherwise specified, locksets requesting "IC" option will be provided with an ANSI strike and UL latch at additional costs shown above.

MK Series Parts

| Strikes | Description | Specify Finish | Strike No. | Price |
|-----------------|---|----------------|------------|---------|
| T-Strike | 1-1/8" x 2-3/4", 1-1/4" lip, square corner | • | 300 | \$8.48 |
| ANSI | 1-1/4" x 4-7/8", 1-1/4" lip, square corner | • | 306 | \$26.71 |
| Full Lip D-Type | 1-3/4" x 2-1/4", 1-1/4" lip, square corner | • | 302 | \$8.48 |
| Radius D-Type | 1-3/4" x 2-1/4", 1-1/4" lip, 1/4" radius corner | • | 303 | \$8.48 |
| Box Strike | Used with 306 ANSI strike | | BX70 | \$5.08 |
| Box Strike | Used with 300, 302, or 303 strike | | BX10 | \$5.08 |

| Latches | Description | Specify Finish | Spring Latch No. | Dead Latch No. | Price |
|----------------|---------------------------|----------------|------------------|----------------|---------|
| 2-3/4" Backset | 1-1/8", square corner | • | 104 | 114 | \$11.79 |
| | 1-1/8", square corner, UL | • | 224 | 124 | \$31.66 |
| | 1", square corner | • | 102 | 112 | \$16.16 |
| | 1", square corner, UL | • | 222 | 122 | \$31.66 |
| | Drive-in | | - | 116 | \$18.36 |
| 2-3/8" Backset | 1", square corner | • | 101 | 111 | \$11.79 |
| | 1", square corner, UL | • | 221 | 121 | \$31.66 |
| | 1", round corner | • | 109 | - | \$16.16 |
| | Drive-in | | - | 115 | \$18.36 |

| Cylinder & Related | Specify Finish | Part No. | Price |
|--|----------------|--------------|---------|
| Standard cylinder (except for B knob) (drilled 6, pinned 5) | • | 100C | \$25.75 |
| Standard cylinder for B knob (drilled 6, pinned 5) | | 100C-750 | \$25.75 |
| Alternate Cylinder (except for B knob) (drilled 6, pinned 6) | • | 300C | \$25.75 |
| Alternate Cylinder for B knob (drilled 6, pinned 6) | | 300C-750 | \$25.75 |
| Hotel cylinder | • | H100C | \$40.12 |
| Standard keyblank | | K5A | \$1.29 |
| Standard tailpiece (except for B knob or hotel function) | | 550AM-44 | \$2.60 |
| Standard tailpiece for B knob (except hotel function) | | 750-44 | \$2.60 |
| Hotel function tailpiece (except for B knob) | | 550H-44 | \$2.60 |
| Hotel function tailpiece for B knob | | 750H-44 | \$2.60 |
| IC core cylinder - See Keys & Cylinders section | | - | - |
| IC core tailpiece pack for 6- & 7-pin cores | | 550CR-44-201 | \$5.03 |

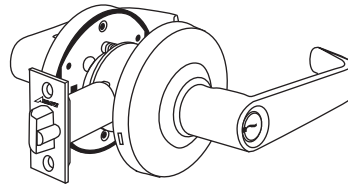

Features

| | |
|---------------------------|---|
| Certification | BHMA A156.2, Series 4000, Grade 2, UL Listed |
| Freewheeling Lever Action | Standard |
| Door Thickness | Fits 1-3/8" to 1-3/4", factory set for 1-3/4" |
| Strike | ANSI 1-1/4" x 4-7/8" |
| Latch | 2-3/4" backset, 1-1/8" front |
| Cylinder | Standard: 6 Pin, solid brass, 2 nickel-plated brass keys; IC prep available |
| Handing | Non-handed |
| Case Quantity | 6 per case |
| Average Case Weight | 27 lbs. |
| Warranty | 10 years |

| Available Finishes | Arrow Code | BHMA Code | U.S. Code |
|-------------------------------------|------------|-----------|-----------|
| Bright Brass | 03 | 605 | US3 |
| Dark Oxide Satin Bronze, equivalent | 613E | 613E | US10BE |
| Satin Chromium Plated | 26D | 626 | US26D |

How to Order

| | |
|-----------------|----------------------------------|
| Function & Trim | MLX81-SB |
| Finish | MLX81-SB-26D |
| Strike | MLX81-SB-26D-306 |
| Latch | MLX81-SB-26D-306-R21 |
| Keying | MLX81-SB-26D-306-R21-ARKD |

| Function | Description | 03, 613E, 26D |
|----------------------------|-----------------|---------------|
| MLX01-SB | Passage | \$123.00 |
| MLX08-SB | Single Dummy | \$49.00 |
| MLX72-SB | Privacy | \$133.00 |
| MLX81-SB | Entrance/Office | \$145.00 |
| MLX82-SB | Storeroom | \$145.00 |
| MLX87-SB | Classroom | \$145.00 |
| MLX93-SB (26D finish only) | Asylum | \$182.00 |

| *** AVAILABLE THROUGH SELECT DISTRIBUTORS – CONTACT ARROW LOCK FOR MORE INFORMATION *** | | |
|---|-------------|---------------|
| Rigid Lever Function | Description | 03, 613E, 26D |
| MLX02-SB | Privacy | \$133.00 |
| MLX11-SB | Entrance | \$145.00 |
| MLX12-SB | Storeroom | \$145.00 |
| MLX17-SB | Classroom | \$145.00 |
| MLX33-SB | Asylum | \$182.00 |

Specify SR trim for MLX design with removable thru-bolts.

MLX Series

Options & Parts

| Keying & Cylinder Options | Specify | Price Add |
|--|------------------|-----------|
| Keyed different, AR keyway | ARKD | Standard |
| Keyed different, CS keyway | CSKD | No Add |
| Lock prepared to accept a 6- or 7-pin SFIC cylinder (not included) | IC | No Add |
| Lock prepared to accept Schlage LFIC cylinder (not included) | SIC ¹ | \$25.00 |

¹ Not available with 10BP or 03 finishes.

| Strike & Latch Options | Spring Latch | Dead Latch | Price Add |
|-------------------------------|--------------|------------|-----------|
| 2-3/4" backset x 1-1/8" front | R23 | R21 | Standard |

| Parts | Part No. | Price |
|--|--------------------------------------|---------|
| Standard cylinder with tailpiece – AR keyway | C700HD | \$25.75 |
| Standard cylinder with tailpiece – CS keyway | C700HD-CS | \$25.75 |
| Strike | 306 | \$26.71 |
| Latch - 2-3/4" backset | R23 ¹ or R21 ² | \$15.59 |
| Screw pack | QL-201 | \$1.89 |
| Standard cylinder tailpiece | 1001SC-44 | \$2.60 |
| Standard cylinder screw cap | SC-01 | \$8.48 |
| Standard cylinder cap pin | SC-02 | \$3.06 |
| Standard cylinder cap spring | SC-03 | \$0.95 |
| IC tailpiece kit (tailpiece & spacer for 6- & 7- pin cores) | RLX-44-201 | \$5.03 |
| Alternate latch – 2-3/8" backset x 1" front (sold only as a separate part) | R22 ¹ or R20 ² | \$15.59 |

¹ Used only with non-keyed functions.

² Used only with keyed functions.

RK Series

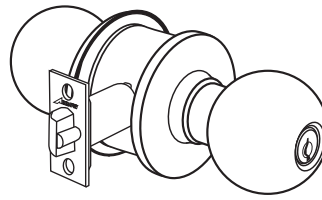

Features

| | |
|---------------------|--|
| Certification | BHMA A156.2, Series 4000, Grade 2, UL Listed |
| Door Thickness | Fits 1-3/8" - 1-3/4", factory set for 1-3/4" |
| Strike | Standard: T-strike, 1-1/8" x 2-3/4"; alternate strikes available |
| Latch | Standard: 2-3/8" backset, 1" front; alternate latches available |
| Cylinder | Standard: 6-pin, solid brass, 2 brass keys; IC prep available |
| Handing | Non-handed |
| Case Quantity | 10 |
| Average Case Weight | 13 lbs. |
| Warranty | 5 years |

| Available Finishes | Arrow Code | BHMA Code | U.S. Code |
|--|------------|-----------|-----------|
| Bright Brass | 03 | 605 | US3 |
| Satin Brass | 04 | 606 | US4 |
| Satin Bronze | 10 | 612 | US10 |
| Dark Oxidized Satin Bronze, Oil Rubbed | 10B | 613 | US10B |
| Polished Stainless Steel | 32 | 629 | US32 |
| Satin Stainless Steel | 32D | 630 | US32D |

How to Order

| | |
|-----------------|---------------------------|
| Function & Trim | RK11-BD |
| Finish | RK11-BD-32D |
| Strike | RK11-BD-32D-R60 |
| Latch | RK11-BD-32D-R60-R70 |
| Keying | RK11-BD-32D-R60-R70-KD-AR |

| Function | ANSI | Description | 03, 32D | 04, 10, 10B, 32 |
|----------|------|--------------|---------|-----------------|
| RK01 | F75 | Passage | \$48.00 | \$58.00 |
| RK02 | F76A | Privacy | \$49.00 | \$59.00 |
| RK08 | — | Single Dummy | \$18.00 | \$23.00 |
| RK11 | F109 | Entrance | \$54.00 | \$64.00 |
| RK12 | F86 | Storeroom | \$54.00 | \$64.00 |
| RK17 | F84 | Classroom | \$54.00 | \$64.00 |

| Less Cylinder (specify "LC" suffix) | |
|--|-----------------|
| 03, 32D | 04, 10, 10B, 32 |
| — | — |
| — | — |
| — | — |
| \$45.45 | \$55.45 |
| \$45.45 | \$55.45 |
| \$45.45 | \$55.45 |

RL Series

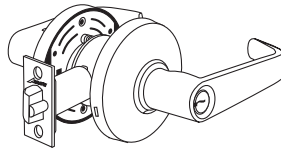

SR Trim

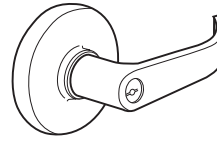

BRR Trim

Features

| | |
|---------------------|---|
| Certification | BHMA A156.2, Series 4000, Grade 2, UL Listed |
| Door Thickness | Fits 1-3/8" - 1-3/4", factory set for 1-3/4" |
| Strike | Standard: ANSI 1-1/4" x 4-7/8"; alternate strikes available |
| Latch | Standard: 2-3/4" backset, 1-1/8" front; alternate latches available |
| Cylinder | Standard: 6-pin, solid brass, 2 brass keys; IC prep available |
| Handing | Non-handed |
| Case Quantity | 10 |
| Average Case Weight | 38 lbs. |
| Warranty | 5 years |

| Available Finishes | Arrow Code | BHMA Code | U.S. Code |
|--|------------|-----------|-----------|
| Bright Brass | 03 | 605 | US3 |
| Satin Brass | 04 | 606 | US4 |
| Satin Bronze | 10 | 612 | US10 |
| Dark Oxidized Satin Bronze, Oil Rubbed | 10B | 613 | US10B |
| Bright Chromium Plated | 26 | 625 | US26 |
| Satin Chromium Plated | 26D | 626 | US26D |

How to Order

| | |
|----------|----------------------------------|
| Function | RL11 |
| Trim | RL11-SR |
| Finish | RL11-SR-26D |
| Strike | RL11-SR-26D-R62 |
| Latch | RL11-SR-26D-R62-R71 |
| Keying | RL11-SR-26D-R62-R71-KD-AR |

| Function | ANSI | Description | 03, 26D | 04, 10, 10B, 26 |
|----------|------|---------------|----------|-----------------|
| RL01 | F75 | Passage | \$91.00 | \$101.00 |
| RL02 | F76A | Privacy | \$94.00 | \$104.00 |
| RL03 | — | Communicating | \$94.00 | \$99.00 |
| RL08 | — | Single Dummy | \$34.00 | \$39.00 |
| RL11 | F109 | Entrance | \$110.00 | \$120.00 |
| RL12 | F86 | Storeroom | \$110.00 | \$120.00 |
| RL17 | F84 | Classroom | \$110.00 | \$120.00 |

| Less Cylinder (specify "LC" suffix) | |
|--|-----------------|
| 03, 26D | 04, 10, 10B, 26 |
| — | — |
| — | — |
| — | — |
| — | — |
| \$101.45 | \$111.45 |
| \$101.45 | \$111.45 |
| \$101.45 | \$111.45 |

RK & RL Series

Options & Parts

| Strike Options | Description | Specify | Price Add |
|----------------|--|---------|-----------|
| T-Strike | 1-1/8" x 2-3/4", 1-1/4" lip, square corner – standard with RK Series | R60 | No Add |
| Square Corner | 1-3/4" x 2-1/4", 1-1/4" lip, square corner – full lip | R61 | No Add |
| ANSI | 1-1/4" x 4-7/8", 1-1/4" lip, square corner – standard with RL Series | R62 | No Add |

| Latch Options | Description | Specify>>> | Spring Latch No. | Dead Latch No. | Price Add |
|----------------|---|------------|------------------|----------------|-----------|
| 2-3/8" Backset | 1", square corner – standard with RK Series | | R72 | R70 | No Add |
| 2-3/4" Backset | 1-1/8", square corner – standard with RL Series | | R73 | R71 | No Add |

| Keying & Cylinder Options | Specify | Price Add |
|---|---------|----------------------|
| Keyed different, AR Keyway | ARKD | Standard |
| Keyed different, CS Keyway | CSKD | No Add |
| Master Keyed | MK | \$13.00 per cylinder |
| Construction Master Keyed | CMK | \$8.16 per cylinder |
| Master Keyed & Construction Master Keyed | MK-CMK | \$21.16 per cylinder |
| Keyed Alike | KA | No Add |
| O-bitted | OB | No Add |
| Less Cylinder | LC | -\$8.55 |
| Lock prepared to accept 6 or 7-pin SFIC Cylinder, less core | IC | No Add |

Parts

| Strikes | Description | Part No. | Price |
|---------------|--|----------|---------|
| T-Strike | 1-1/8" x 2-3/4", 1-1/4" lip, square corner | R60 | \$7.94 |
| Square Corner | 1-3/4" x 2-1/4", 1-1/4" lip, square corner | R61 | \$7.94 |
| ANSI | 1-1/4" x 4-7/8", 1-1/4" lip, square corner | R62 | \$26.71 |

| Latches | Description | Spring Latch | Dead Latch | Price |
|----------------|-----------------------|--------------|------------|---------|
| 2-3/8" Backset | 1", square corner | R72 | R70 | \$16.16 |
| | Drive-in ¹ | R76 | R74 | \$16.16 |
| 2-3/4" Backset | 1-1/8", square corner | R73 | R71 | \$16.16 |
| | Drive-in ¹ | R77 | R75 | \$16.16 |

| Cylinders & Related | Part No. | Price | |
|---------------------|--|--------------|---------|
| Standard cylinder | 100C-RK | \$25.75 | |
| RK Series | Standard keyblank | K5A | \$1.29 |
| | Standard tailpiece | 550RK-44 | \$2.60 |
| | IC tailpiece pack for 6- & 7-pin cores | 100CR-44-201 | \$5.03 |
| | Standard cylinder | 600HD | \$25.75 |
| RL Series | Standard keyblank | K6A | \$1.29 |
| | Standard tailpiece | 1001-44 | \$2.60 |
| | 6-Pin IC core tailpiece | HSCR6-44 | \$3.10 |
| | 7-Pin IC core tailpiece | HSCR7-44 | \$3.10 |

¹ Sold only as a separate part; specify 26D or 03 finish.

CL Series

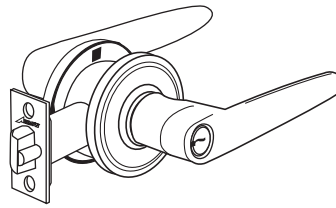

Features

| | |
|---------------------|---|
| Certification | BHMA A156.2, Series 4000, Grade 2 |
| Door Thickness | Fits 1-3/8" - 1-3/4", factory set for 1-3/4" |
| Strike | Standard: Full lip 1-5/8" x 2-1/4"; alternate strikes available |
| Latch | Standard: 2-3/8" - 2-3/4" adj. backset, 1" front; alternate latches available |
| Cylinder | 6-pin, solid brass, 2 brass keys |
| Handing | Non-handed |
| Case Quantity | 20 |
| Average Case Weight | 38 lbs. |
| Warranty | 5 years |

| Available Finishes | Arrow Code | BHMA Code | U.S. Code |
|------------------------|------------|-----------|-----------|
| Bright Brass | 03 | 605 | US3 |
| Satin Brass | 04 | 606 | US4 |
| Antique Brass | 05A | 609 | US5 |
| Satin Nickel | 15 | 619 | US15 |
| Bright Chromium Plated | 26 | 625 | US26 |
| Satin Chromium Plated | 26D | 626 | US26D |

How to Order

| | |
|----------|---------------------------|
| Function | CL11 |
| Trim | CL11-SC |
| Finish | CL11-SC-26D |
| Strike | CL11-SC-26D-502 |
| Latch | CL11-SC-26D-502-511 |
| Keying | CL11-SC-26D-502-511-KD-AR |

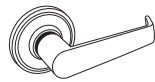

SC



LC¹



VC



OC¹

| Function | Description | SC | VC | LC, OC |
|----------|--------------|----------|----------|---------|
| CL01 | Passage | \$73.00 | \$71.00 | \$67.00 |
| CL02 | Privacy | \$79.00 | \$77.00 | \$73.00 |
| CL04 | Patio | \$78.00 | \$76.00 | \$72.00 |
| CL08 | Single Dummy | \$34.00 | \$33.00 | \$31.00 |
| CL11 | Entrance | \$103.00 | \$101.00 | \$97.00 |
| CL12 | Storeroom | \$103.00 | \$101.00 | \$97.00 |

¹ Handing required for LC & OC trim designs.

CL Series Options & Parts

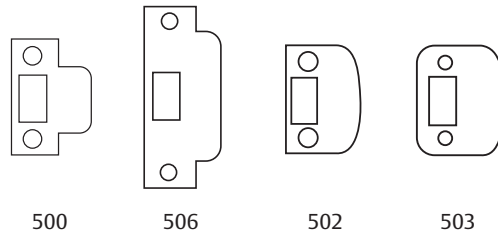

| Strike Options | Description | Specify | Price Add |
|-----------------|---|---------|-----------|
| T-Strike | 1-1/8" x 2-3/4", 1-1/4" lip, square corner | 500 | No Add |
| ANSI | 1-1/4" x 4-7/8", 1-1/4" lip, square corner | 506 | \$8.06 |
| Full Lip D-Type | 1-3/4" x 2-1/4", 1-1/4" lip, square corner | 502 | Standard |
| Radius D-Type | 1-3/4" x 2-1/4", 1-1/4" lip, 1/4" radius corner | 503 | No Add |

| Latch Options | Description | Specify >>> | Spring Latch | Dead Latch | Price Add |
|--------------------|-----------------------|-------------|--------------|------------|-----------|
| 2-3/8" - 2-3/4" | Includes 3 faceplates | | 501 | 511 | Standard |
| Adjustable Backset | Drive-in | | 505 | 515 | No Add |
| Less Latch | | | | LAT | -\$4.35 |

| Keying & Cylinder Options | Specify | Price Add |
|--|---------|----------------------|
| Keyed alike in four (quantity permitting otherwise KD) | KA4 | Standard |
| Keyed different | KD | No Add |
| Master keyed | MK | \$13.00 per cylinder |
| Construction master keyed | CMK | \$8.16 per cylinder |
| Master keyed & construction master keyed | MK-CMK | \$21.16 per cylinder |
| O-Bitted | OB | No Add |
| Less Cylinder | LC | -\$8.55 |

| Strikes | Description | Specify Finish | Part No. | Price |
|-----------------|---|----------------|----------|---------|
| T-Strike | 1-1/8" x 2-3/4", 1-1/4" Lip, Square Corner | • | 500 | \$5.08 |
| ANSI | 1-1/4" x 4-7/8", 1-1/4" Lip, Square Corner | • | 506 | \$13.14 |
| Full Lip D-Type | 1-3/4" x 2-1/4", 1-1/4" Lip, Square Corner | • | 502 | \$5.08 |
| Radius D-Type | 1-3/4" x 2-1/4", 1-1/4" Lip, 1/4" Radius Corner | • | 503 | \$5.08 |

| Latches | Description | Specify Finish | Spring Latch No. | Dead Latch No. | Price |
|--------------------|-----------------------|----------------|------------------|----------------|---------|
| 2-3/8" - 2-3/4" | Includes 3 faceplates | • | 501 | 511 | \$13.14 |
| Adjustable Backset | Drive-in | | 505 | 515 | \$13.14 |

| Cylinder & Related | Part No. | Price |
|----------------------------------|----------|---------|
| Standard key blank | K5A | \$1.29 |
| Standard cylinder for CL Series | 100YC | \$25.75 |
| Standard tailpiece for CL Series | 10CL-44 | \$2.60 |

RLX Series

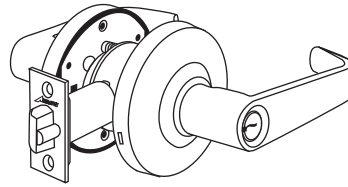

Features

| | |
|---------------------------|---|
| Certification | BHMA A156.2, Series 4000, Grade 2, UL Listed |
| Freewheeling Lever Action | Standard |
| Door Thickness | Fits 1-3/8" to 1-3/4", factory set for 1-3/4" |
| Strike | ANSI 1-1/4" x 4-7/8" |
| Latch | 2-3/4" backset, 1-1/8" front |
| Cylinder | Standard: 6-pin, solid brass, 2 nickel-plated brass keys; IC prep available |
| Handing | Non-handed |
| Case Quantity | 6 per case |
| Average Case Weight | 26 lbs. |
| Warranty | 10 years |

| Available Finishes | Arrow Code | BHMA Code | U.S. Code |
|-------------------------------------|------------|-----------|-----------|
| Bright Brass | 03 | 605 | US3 |
| Dark Oxide Satin Bronze, equivalent | 613E | 613E | US10BE |
| Satin Chromium Plated | 26D | 626 | US26D |

How to Order

| | |
|-----------------|----------------------------------|
| Function & Trim | RLX81-SR |
| Finish | RLX81-SR-26D |
| Strike | RLX81-SR-26D-306 |
| Latch | RLX81-SR-26D-306-R21 |
| Keying | RLX81-SR-26D-306-R21-ARKD |

| *** AVAILABLE THROUGH SELECT DISTRIBUTORS – CONTACT ARROW LOCK FOR MORE INFORMATION *** | | | |
|---|-----------------|----------|----------|
| Function | Description | 03, 26D | 613E |
| RLX01-SR | Passage | \$104.00 | \$115.00 |
| RLX08-SR | Single Dummy | \$40.00 | \$45.00 |
| RLX72-SR | Privacy | \$108.00 | \$120.00 |
| RLX81-SR | Entrance/Office | \$126.00 | \$137.00 |
| RLX82-SR | Storeroom | \$126.00 | \$137.00 |
| RLX87-SR | Classroom | \$126.00 | \$137.00 |

RLX Series

Options & Parts

| Strike Option | Specify | Price Add |
|---------------|---------|-----------|
| ANSI | 306 | Standard |

| Latch Options | Spring Latch | Dead Latch | Price Add |
|-------------------------------|--------------|------------|-----------|
| 2-3/4" backset x 1-1/8" front | R23 | R21 | Standard |

| Keying & Cylinder Options | Specify | Price Add |
|--|---------|-----------|
| Keyed different, AR keyway | ARKD | Standard |
| Keyed different, CS keyway | CSKD | No add |
| Lock prepared to accept a 6- or 7-pin SFIC cylinder (not included) | IC | No add |

| Parts | Part No. | Price |
|--|--------------------------------------|---------|
| Standard cylinder with tailpiece – AR keyway | C700HD | \$25.75 |
| Standard cylinder with tailpiece – CS keyway | C700HD-CS | \$25.75 |
| Strike | 306 | \$26.71 |
| Latch - 2-3/4" backset | R23 ¹ or R21 ² | \$15.59 |
| Latch - 2-3/8" backset latch x 1" front (sold only as separate part) | R22 ¹ or R20 ² | \$15.59 |
| Screw pack for latch & strike | RLX-201 | \$1.89 |
| Screw pack for chassis, rose, & thru-bolts | RLX-201A | \$1.89 |
| Standard cylinder tailpiece | 1001SC-44 | \$2.60 |
| Standard cylinder screw cap | SC-01 | \$8.48 |
| Standard cylinder cap pin | SC-02 | \$3.06 |
| Standard cylinder cap spring | SC-03 | \$0.95 |
| IC tailpiece kit (tailpiece & spacer for 6- & 7-pin cores) | RLX-44-201 | \$5.03 |

¹Used only with non-keyed functions

²Used only with keyed functions

DBX Series

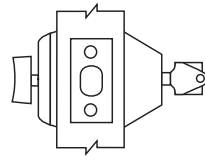

DBX61

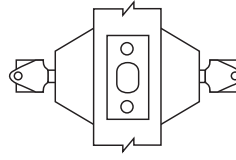

DBX62

Features

| | |
|---------------------|---|
| Certification | BHMA A156.36 Auxiliary Locks, Grade 2, UL Listed |
| Door Thickness | Fits 1-3/8" - 1-3/4", factory set for 1-3/4" |
| Strike | 2-3/4" x 1-1/8", square corners |
| Latch | 2-3/8" - 2-3/4", adjustable backset, 1" front, includes spacer for 1-1/8" door prep |
| Cylinder | 6-pin, solid brass, keyed alike in 4, CS keyway includes 2 brass keys |
| Handing | Non-handed |
| Case Quantity | 12 |
| Average Case Weight | DBX61 - 18lbs. / DBX62 - 22lbs. |
| Warranty | 1 year |

| Available Finishes | Arrow Code | BHMA Code | U.S. Code |
|--|------------|-----------|-----------|
| Bright Brass | 605 | 605 | US3 |
| Dark Oxidized Satin Bronze, equivalent | 613E | 613E | US10BE |
| Satin Stainless Steel | 630 | 630 | US32D |

How to Order

| | |
|----------|--------------------------|
| Function | DBX61 |
| Finish | DBX61- 630 |
| Keying | DBX61-630- CS-KA4 |

| Function | Description | 630 | 605, 613E |
|----------|----------------------|---------|-----------|
| DBX61 | Cylinder x Thumbturn | \$43.00 | \$51.00 |
| DBX62 | Cylinder x Cylinder | \$61.00 | \$69.00 |

DBX Series

Options & Parts

Options

| Strike Option | Specify | Price Add |
|---------------------------------|---------|-----------|
| 2-3/4" x 1-1/8", square corners | 394 | Standard |

| Latch Option | Specify | Price Add |
|-------------------------------------|---------|-----------|
| 2-3/8" - 2-3/4", adjustable backset | L14 | Standard |

| Keying & Cylinder Options | Specify | Price Add |
|--|---------|-----------|
| CS keyway, keyed alike in 4 | CS-KA4 | Standard |
| AR keyway, keyed alike in 4 | AR-KA4 | No Add |
| Lock prepared to accept a 6- or 7-pin SFIC cylinder (not included) | IC | \$20.00 |

Parts

| Parts | Part No. | Price Add |
|---|-------------|-----------|
| Cylinder for DBX61 x CS keyway, keyed different | 96C-CS-DBX | \$20.01 |
| Cylinder for DBX61 x AR keyway, keyed different | 96C-DBX | \$20.01 |
| Cylinder for DBX62 x CS keyway, keyed different | 96DC-CS-DBX | \$20.01 |
| Cylinder for DBX62 x AR keyway, keyed different | 96DC-DBX | \$20.01 |
| Strike | DBX-394 | \$6.58 |
| Standard bolt | DBX-L14 | \$14.27 |
| Optional drive in bolt (sold only as a separate part) | DBX-L18 | \$14.27 |
| Screw pack for DBX61 | DBX61-201 | \$8.48 |
| Screw pack for DBX62 | DBX62-201 | \$8.48 |
| Thick door pack for DBX61, up to 2" thick doors | DBX61-TDP | \$8.48 |
| Thick door pack for DBX62, up to 2" thick doors | DBX62-TDP | \$8.48 |

D Series

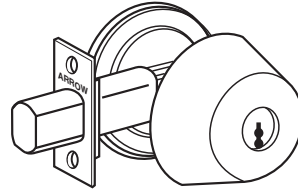

Features

| | |
|---------------------|---|
| Certification | BHMA A156.5, Grade 1, UL Listed |
| Door Thickness | Fits 1-3/8" - 1-3/4", factory set for 1-3/4" |
| Strike | Standard: 1-1/8" x 2-1/4"; alternate strikes available |
| Latch | Standard: 2-3/4" backset, 1-1/8" front; alternate bolts available |
| Cylinder | Standard: 6-pin, solid brass, 2 nickel-silver keys; IC prep available |
| Handing | Non-handed |
| Case Quantity | 12 |
| Average Case Weight | 22 lbs. |
| Warranty | 1 year |

| Available Finishes | Arrow Code | BHMA Code | U.S. Code |
|--|------------|-----------|-----------|
| Bright Brass | 03 | 605 | US3 |
| Satin Brass | 04 | 606 | US4 |
| Black Suede Powder | BSP | - | - |
| Antique Brass | 05A | 609 | US5 |
| Satin Bronze | 10 | 612 | US10 |
| Dark Oxidized Satin Bronze, Oil Rubbed | 10B | 613 | US10B |
| Dark Oxidized Satin Bronze, equivalent | 10BE | 613E | US10BE |
| Bright Chromium Plated | 26 | 625 | US26 |
| Satin Chromium Plated | 26D | 626 | US26D |

How to Order

| | |
|----------|------------------------------|
| Function | D61 |
| Finish | D61-26D |
| Strike | D61-26D-346 |
| Latch | D61-26D-346-144 |
| Keying | D61-26D-346-144-KD-AR |

| Function | ANSI | Description | 03, 26D | 04, 05A, 10, 10B, 10BE, 26, BSP |
|---------------------|--------|----------------------------------|----------|---------------------------------|
| D60 | E01111 | Thumbturn x Blank Plate | \$94.00 | \$104.00 |
| D61 | E0151 | Cylinder x Thumbturn | \$108.00 | \$118.00 |
| D62 | E0141 | Double Cylinder | \$141.00 | \$151.00 |
| D63 | E0161 | Cylinder x Blank Plate | \$113.00 | \$123.00 |
| D64 | E0171 | Cylinder x Thumbturn (classroom) | \$113.00 | \$123.00 |
| D71-IC ¹ | E0151 | Cylinder x Thumbturn | \$171.00 | \$181.00 |
| D73-IC ¹ | E0161 | Cylinder x Blank Plate | \$171.00 | \$181.00 |
| D74-IC ¹ | E0171 | Cylinder x Thumbturn (classroom) | \$171.00 | \$181.00 |

¹Concealed mounting screws standard on D71 & D73 functions.

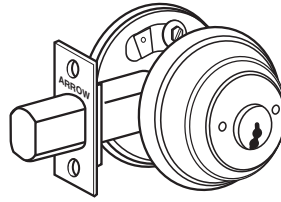

Features

| | |
|---------------------|--|
| Certification | BHMA A156.5, Grade 2, UL Listed |
| Door Thickness | Fits 1-3/8" - 1-3/4", factory set for 1-3/4" |
| Strike | Standard: 1-1/8" x 2-1/4"; alternate strikes available |
| Latch | Standard: 2-3/8" backset, 1-1/8" front; alternate bolts available |
| Cylinder | Standard: 6-pin, keyed 5, solid brass, 2 brass keys; IC prep available |
| Handing | Non-handed |
| Case Quantity | 12 |
| Average Case Weight | E61 - 20 lbs. / E62 - 25 lbs. |
| Warranty | 1 year |

| Available Finishes | Arrow Code | BHMA Code | U.S. Code |
|--|------------|-----------|-----------|
| Bright Brass | 03 | 605 | US3 |
| Satin Brass | 04 | 606 | US4 |
| Black Suede Powder | BSP | - | - |
| Antique Brass | 05A | 609 | US5 |
| Satin Bronze | 10 | 612 | US10 |
| Dark Oxidized Satin Bronze, Oil Rubbed | 10B | 613 | US10B |
| Dark Oxidized Satin Bronze, equivalent | 10BE | 613E | US10BE |
| Satin Nickel | 15 | 619 | US15 |
| Bright Chromium Plated | 26 | 625 | US26 |
| Satin Chromium Plated | 26D | 626 | US26D |

How to Order

| | |
|----------|------------------------------|
| Function | E61 |
| Finish | E61-26D |
| Strike | E61-26D-346 |
| Latch | E61-26D-346-141 |
| Keying | E61-26D-346-141-KD-AR |

| Function | ANSI | Description | 03, 26D | 04, 05A, 10, 10B, 10BE, 15, 26, BSP |
|------------------------------|--------|----------------------------------|---------|-------------------------------------|
| E50 | - | Occupancy Indicator | \$58.00 | \$68.00 |
| E60 | E01112 | Thumbturn x Blank Plate | \$50.00 | \$60.00 |
| E61 | E0152 | Cylinder x Thumbturn | \$61.00 | \$71.00 |
| E62 | E0142 | Double Cylinder | \$76.00 | \$86.00 |
| E63 | E0162 | Cylinder x Blank Plate | \$68.00 | \$78.00 |
| E64 | E0172 | Cylinder x Thumbturn (classroom) | \$68.00 | \$78.00 |
| E71-IC ¹ | E0152 | Cylinder x Thumbturn | \$86.00 | \$96.00 |
| E74-IC ¹ | E0172 | Cylinder x Thumbturn (classroom) | \$93.00 | \$103.00 |
| E41 Low Profile ² | - | Cylinder x Thumbturn | \$58.00 | \$68.00 |
| E42 Low Profile ² | - | Double Cylinder | \$73.00 | \$83.00 |

¹ Furnished with concealed mounting screws.

² Only available in 03, 26D, and 15 finishes.

D & E Series Options



345



346

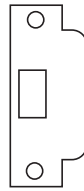

347

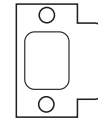

350

| Strike Options | Description | Specify | Price Add |
|----------------|---|---------|-----------|
| Square Corner | 345 & 346 strikes | 395 | Standard |
| Square Corner | 1-1/8" x 2-3/4", for wood jambs (4 mounting holes) | 345 | No Add |
| Square Corner | 1-1/8" x 2-3/4", for metal jambs (2 mounting holes) | 346 | No Add |
| ANSI | 1-1/4" x 4-7/8", 1-1/4" lip, square corner | 347 | No Add |
| T-Strike | 1-1/8" x 2-3/4", 1-1/4" lip, square corner | 350 | No Add |

| Bolt Options | Description | Specify >>> | Spring Latch | Dead Latch | Price Add |
|----------------|-----------------------|-------------|--------------|------------|---------------------|
| 2-3/4" Backset | 1-1/8", square corner | | | 144 | Standard (D Series) |
| 2-3/8" Backset | 1", square corner | | | 141 | Standard (E Series) |
| 2-3/4" Backset | 1", square corner | | | 142 | No Add |
| 2-3/8" Backset | Drive-in | | | 145 | No Add |
| 2-3/4" Backset | Drive-in | | | 146 | No Add |
| Less Latch | | | | LAT | -\$6.10 |

| Keying & Cylinder Options | Specify | Price Add |
|---|---------|----------------------|
| Keyed different | KD | Standard (D Series) |
| Keyed alike in four (quantity permitting) | KA4 | Standard (E Series) |
| Master keyed ¹ | MK | \$13.00 per cylinder |
| Construction master keyed ¹ | CMK | \$8.16 per cylinder |
| Master keyed & construction master keyed ¹ | MK-CMK | \$21.16 per cylinder |
| O-Bitted ¹ | OB | No Add |
| Less Cylinder ¹ | LC | -\$8.55 |
| Lock prepared to accept 6 or 7-pin IC cylinder, less core | IC | \$25.00 |

¹ Not available with E41 or E42 function.

| Strikes | Description | Specify Finish | Part No. | Price |
|-------------------------|---|----------------|----------|---------|
| Square Corner | 1-1/8" x 2-3/4", for metal jambs (4 mounting holes) | • | 345 | \$8.48 |
| Square Corner | 1-1/8" x 2-3/4", for wood jambs (2 mounting holes) | • | 346 | \$8.48 |
| ANSI | 1-1/4" x 4-7/8" | • | 347 | \$16.73 |
| T-Strike | 1-1/8" x 2-3/4", 1-1/4" lip | • | 350 | \$8.48 |
| Box strike for E Series | | | BX91 | \$2.73 |
| Box strike for D Series | | | BX91D | \$2.73 |

| Bolts | Description | Specify Finish | Part No. | Price |
|--------|-----------------------|----------------|----------|---------|
| 2-3/4" | 1-1/8", square corner | • | 144 | \$18.36 |
| 2-3/8" | 1", square corner | • | 141 | \$18.36 |
| 2-3/4" | 1", square corner | • | 142 | \$18.36 |
| 2-3/8" | Drive-in | • | 145 | \$18.36 |
| 2-3/4" | Drive-in | • | 146 | \$18.36 |

| Cylinder & Related | Specify Finish | Part No. | Price |
|--|----------------|------------------|---------|
| Standard cylinder for E61, E63, E64 | • | 96C ¹ | \$25.75 |
| Standard cylinder for E62 | • | 96DC | \$25.75 |
| Standard cylinder for E41 | • | 100 | \$25.75 |
| Standard cylinder for E42 | • | 100DC | \$25.75 |
| Standard cylinder for D61, D63, D64 | • | 692C | \$25.75 |
| Standard cylinder for D62 | • | 692DC | \$25.75 |
| Single cylinder tailpiece, 1-3/8" to 1-3/4" thick door | | D61-44 | \$2.60 |
| E42 tailpiece for 1-3/4" thick door | | D62-44J | \$2.60 |
| E42 tailpiece for 1-3/8" thick door | | D62CR-44 | \$2.60 |
| Double cylinder tailpiece, 1-3/4" thick door | | D62-44 | \$2.60 |
| Double cylinder tailpiece, 1-3/8" thick door | | D62-44-13/8 | \$2.60 |
| E60/D60 Function tailpiece | | E60-44 | \$2.60 |
| Cam assembly for 6 & 7-pin IC cylinders | | D61CR-121A | \$5.03 |

¹ When ordered separately, can be installed on E41 for use on 1-3/4" thick door installation.

| Parts & Accessories | Specify Finish | Part No. | Price |
|---------------------------------------|----------------|----------|--------|
| E50 Screwpack | | E50-201 | \$8.48 |
| E60 Screwpack | | E60-201 | \$8.48 |
| D60 Screwpack | | D60-201 | \$8.48 |
| E61 Screwpack | • | E61-201 | \$8.48 |
| D61 Screwpack | • | D61-201 | \$8.48 |
| E62/D62 Screwpack | • | DE62-201 | \$8.48 |
| E61 Thick door pack, up to 2-1/4" | • | E61-TDP | \$8.48 |
| D61 Thick door pack, up to 2-1/4" | • | D61-TDP | \$8.48 |
| E62/D62 Thick door pack, up to 2-1/4" | • | E62-TDP | \$8.48 |

N Series

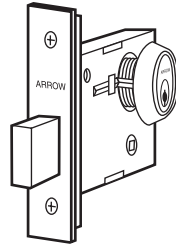

Features

| | |
|---------------------|---|
| Certification | UL Listed |
| Door Thickness | Fits 1-3/8" - 1-3/4" |
| Strike | Standard: 1-1/8" x 3-1/2"; alternate strikes available |
| Bolt | 1" throw with hardened pin |
| Backset | 2-3/4" |
| Cylinder | Standard: 6-pin, solid brass, 2 nickel-silver keys; IC prep available |
| Handing | Non-handed |
| Case Quantity | 20 |
| Average Case Weight | 38 lbs. |
| Warranty | 1 year |

| Available Finishes | Arrow Code | BHMA Code | U.S. Code |
|--|------------|-----------|-----------|
| Bright Brass | 03 | 605 | US3 |
| Satin Brass | 04 | 606 | US4 |
| Satin Bronze | 10 | 612 | US10 |
| Dark Oxidized Satin Bronze, Oil Rubbed | 10B | 613 | US10B |
| Dark Oxidized Satin Bronze, equivalent | 10BE | 613E | US10BE |
| Bright Chromium Plated | 26 | 625 | US26 |
| Satin Chromium Plated | 26D | 626 | US26D |

How to Order

| | |
|----------|--------------------------|
| Function | N41 |
| Finish | N41-26D |
| Strike | N41-26D-380 |
| Keying | N41-26D-380-KD-AR |

| Function | ANSI | Description | 26D | 03, 04, 10, 10B, 10BE, 26 |
|----------|--------|----------------------------------|----------|---------------------------|
| N40 | - | Thumbturn One Side | \$207.00 | \$214.00 |
| N41 | E06071 | Cylinder x Thumbturn | \$238.00 | \$245.00 |
| N42 | E06061 | Double Cylinder | \$247.00 | \$254.00 |
| N43 | E06081 | Cylinder One Side | \$216.00 | \$223.00 |
| N44 | E06091 | Cylinder x Thumbturn (classroom) | \$242.00 | \$249.00 |

N Series Options & Parts



380



356

| Strike Options | Description | Specify | Price Add |
|----------------|-----------------|---------|-----------|
| Square Corner | 1-1/8" x 3-1/2" | 380 | Standard |
| ANSI | 1-1/4" x 4-7/8" | 356 | \$8.25 |

| Keying & Cylinder Options | Specify | Price Add |
|--|---------|----------------------|
| Keyed different | KD | Standard |
| Master keyed | MK | \$13.00 per cylinder |
| Construction master keyed | CMK | \$8.16 per cylinder |
| Master keyed & construction master keyed | MK-CMK | \$21.16 per cylinder |
| O-Bitted | OB | No Add |
| Less Cylinder | LC | -\$13.35 |
| Lock prepared to accept 6-pin SFIC cylinder, less core | IC6 | No Add |
| Lock prepared to accept 7-pin SFIC cylinder, less core | IC7 | No Add |

Auxiliary Locks



836-17A

| Parts | Specify Finish | Part No. | Price |
|---------------------------------------|----------------|----------|----------|
| Standard mortise cylinder | • | MC61-004 | \$40.12 |
| Square corner strike, 1-1/8" x 3-1/2" | • | 380 | \$8.48 |
| ANSI strike, 1-1/4" x 4-7/8" | • | 356 | \$8.25 |
| Thumbturn | • | 836-17A | \$22.93 |
| Faceplate & screw pack | • | 836-204 | \$19.67 |
| Lock body only | | 836K-LB | \$156.00 |

Padlocks

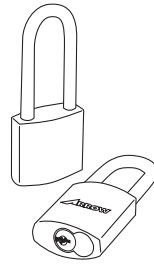

SFIC Padlocks (cylinder not included)

| Shackle | Part No. | Price |
|---------|----------|---------|
| 1" | EPC1-IC | \$70.00 |
| 2" | EPC2-IC | \$72.00 |
| 3" | EPC3-IC | \$73.00 |

Keys & Keying Charges

Standard Cylinders



K Bow



L Bow

| Key Blanks | Part No. | Price |
|---|----------------------------|--------|
| Standard bow, 5-pin key blank, "A" keyway | K5A | \$1.29 |
| Standard bow, 6-pin key blank, "A" keyway | K6A | \$1.29 |
| Large bow, 6-pin key blank, "A" keyway | L6A | \$2.08 |
| Sectional keyway, standard bow, 6-pin | K671 x (kwy ¹) | \$2.08 |
| Sectional keyway, large bow, 6-pin | L671 x (kwy ¹) | \$2.08 |

¹ Consult factory for Arrow sectional keyways.

| Cut Keys | Price |
|---------------------------|----------------|
| Extra cut keys | \$4.33 per key |
| Master or Grandmaster key | \$8.74 |
| Construction master key | \$8.74 |

| Keying Charges | Price |
|---------------------------|----------------------|
| Master keyed | \$13.00 per cylinder |
| Construction master keyed | \$8.16 per cylinder |
| Keyed different | No Add |
| Keyed alike | No Add |
| 0-Bitted | No Add |

| Key Stamping | Price |
|---|-----------------|
| Stamping key with letters and/or numbers (limited to key space) | \$4.68 per side |
| Stamping key with <i>US Property Do Not Duplicate</i> | \$1.69 per side |
| Stamping non-IC key ² with <i>Do Not Duplicate</i> | \$1.69 per side |

| Key Control for factory-master-keyed systems | Specify | Price |
|---|---------|----------------|
| Stamping cylinder (visual) and 2 keys with standard keying symbols | VKC | \$4.68 per set |
| Stamping cylinder (concealed) and 2 keys with standard keying symbols | CKC | \$4.68 per set |
| Stamping each additional key with standard keying symbols | | \$3.13 per key |

² Coining on IC keys include: *Duplication Prohibited* or *It Is Unlawful To Duplicate This Key*.

| Bitting list only or bitting list copy | Bitting List | \$105.00 |
|--|--------------|----------|
| <ul style="list-style-type: none"> • Bitting lists are provided on disks. Systems not available on disk will be provided on paper. • Large key systems on paper will be priced on a case-by-case basis. • Copies of bitting lists may require prior factory approval. | | |

Cylinders

Mortise & Rim



Mortise Cylinder

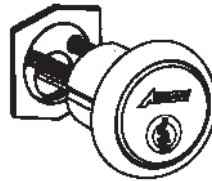

Rim Cylinder

| Mortise Cylinders ¹ | Specify Finish | Part No. | Price |
|--------------------------------|----------------|--------------|---------|
| Standard 1-1/8" cylinder | • | MC61-(cam) | \$40.12 |
| 1-1/4" Cylinder | • | MC61-2-(cam) | \$40.12 |
| 1-1/2" Cylinder | • | MC61-3-(cam) | \$59.25 |
| 2" Cylinder | • | MC61-4-(cam) | \$59.25 |

¹ Standard 001 cam supplied unless otherwise specified.

| Mortise Cylinder Parts | Specify Finish | Part No. | Price |
|---|----------------|----------|--------|
| Cam for mortise lock functions 12, 17, 22, 23, 24, 27, 32 (I/S), 33, 37 | | 001 | \$3.47 |
| Cam for mortise lock functions 11, 13, 19, 20, 21, 31, 32 (O/S), 34, 38, 40, 41, 42, 44 | | AM2 | \$3.47 |
| Cam for N series, panic device trims, alarms | | 004 | \$3.47 |
| Cam for Schlage locks | | 006 | \$3.47 |
| Cam for Adam Rite locks | | AR18 | \$3.47 |
| Cylinder collar and spring | • | 16-113A | \$9.24 |

| Rim Cylinders | Specify Finish | Part No. | Price |
|-------------------------|----------------|----------|---------|
| Standard 6-pin cylinder | • | RC62 | \$40.12 |

| Rim Cylinder Parts | Part No. | Price |
|-----------------------|----------|--------|
| Cam bar for RC62 | 16RC-44 | \$2.60 |
| Plug/cam bar retainer | 16RC-103 | \$1.24 |

ASSA ABLOY

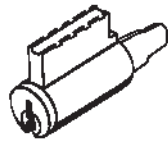

Cylindrical Lock Cylinder

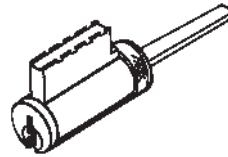

Deadbolt Cylinder

Conventional Cylinders Cylindrical Locks & Deadbolts

| Cylindrical Lock Cylinders | Specify Finish | Part No. | Price |
|--|----------------|----------|---------|
| MK Series (except hotel function) | • | 100C | \$25.75 |
| MK Series hotel function | • | H100C | \$40.12 |
| Cylinder kit (D/B style cyl w/3 D/B cambars, 3 KIK/KIL tail pcs, D/B washer) | • | K100C | \$30.39 |

| Tailpiece Application | Part No. | Price |
|---|----------|--------|
| Q, W, H, S, ML, L & RL Series (except hotel function) | 1001-44 | \$2.60 |
| Q, W, H, & ML Series hotel function | 1001H-44 | \$2.60 |
| MK Series with TA or DD trim (except hotel function) | 550AM-44 | \$2.60 |
| MK Series with BD trim (except hotel function), and RK Series | 750-44 | \$2.60 |
| MK Series hotel function with TA or DD trim | 550H-44 | \$2.60 |
| MK Series hotel function with BD trim | 750H-44 | \$2.60 |

| Deadbolt Cylinders | Specify Finish | Part No. | Price |
|--------------------------|----------------|----------|---------|
| E Series single cylinder | • | 96C | \$25.75 |
| E Series double cylinder | • | 96DC | \$25.75 |
| D Series single cylinder | • | 692C | \$25.75 |
| D Series double cylinder | • | 692DC | \$25.75 |

| Tailpiece Application | Part No. | Price |
|---|-------------|--------|
| D & E Series single cylinder, 1-3/8" to 1-3/4" thick door | D61-44 | \$2.60 |
| D & E Series double cylinder, 1-3/4" thick door | D62-44 | \$2.60 |
| D & E Series double cylinder, 1-3/8" thick door | D62-44-13/8 | \$2.60 |

| Available Keyways | Arrow Equivalent |
|-------------------|------------------|
| Arrow A | AR |
| Schlage C | CS |

Keys & Cylinders

IC Housings

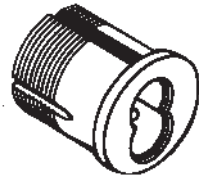

Mortise IC Housing

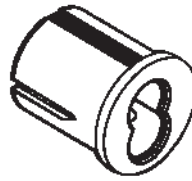

Rim IC Housing

| Mortise Housings ¹ | | Specify Finish | Part No. | Price |
|-------------------------------|----------|----------------|----------------|---------|
| 6-pin housings, 1-1/8" | Standard | • | 16CR-16X (cam) | \$39.34 |
| | Tapered | • | 16CRT-16XAR18 | \$40.85 |
| 7-pin housings, 1-1/4" | Standard | • | 16CR-27X (cam) | \$39.34 |
| | Tapered | • | 16CRT-27XAR18 | \$40.85 |

¹ Standard 16CR-001 cam supplied unless otherwise specified.

| Mortise Housing Parts | Specify Finish | Part No. | Price |
|---|----------------|------------|---------|
| Cam for mortise lock functions 12, 17, 22, 23, 24, 27, 32 (I/S), 33, 37 | | 16CR-001 | \$3.47 |
| Cam for mortise lock functions 11, 13, 19, 20, 21, 31, 32 (O/S), 34, 38, 40, 41, 42, 44 | | 16CR-AM2 | \$3.47 |
| Cam for N series, panic device trims, alarms | | 16CR-004 | \$3.47 |
| Cam for Schlage locks | | 16CR-006 | \$3.47 |
| Cam for Adams Rite locks | | 16CR-AR18 | \$3.47 |
| 1/8" Spacer ring | • | 16CR-123-1 | \$13.47 |
| 1/4" Spacer ring | • | 16CR-123-2 | \$13.47 |
| 3/8" Spacer ring | • | 16CR-123-3 | \$13.47 |

| Rim Housings | Specify Finish | Part No. | Price |
|---------------|----------------|----------|---------|
| 6-pin housing | • | 16RCR-16 | \$39.34 |
| 7-pin housing | • | 16RCR-27 | \$39.34 |

| Rim Housing Parts | Part No. | Price |
|---------------------------------|------------|--------|
| Cam bar | 16RCR-44 | \$2.60 |
| Cam assembly (equal leg prongs) | 16RCR-121A | \$8.48 |
| Spring washer | 16RCR-125 | \$0.78 |
| Yoke plate | 961CR-117 | \$0.96 |
| Pan head screw (2 required) | 4-40X1/4 | \$0.44 |

• See *Plus Housings* section for Plus-related components.



Pointe SFIC Cylinders

| SFIC Cylinders with Standard Barrel Caps | | Part No. | 04, 26D |
|--|-----------------------|------------------|---------|
| 6-pin core | Uncombined | 100CR-UCX (kwy) | \$20.38 |
| | Combined ¹ | 100CR- (kwy) | \$38.54 |
| 7-pin core | Uncombined | 7100CR-UCX (kwy) | \$20.38 |
| | Combined ¹ | 7100CR- (kwy) | \$38.54 |

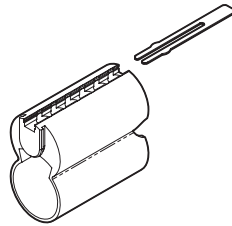

| SFIC Cylinders with Slide Cover | | Part No. | 04, 26D |
|---------------------------------|-----------------------|------------------|---------|
| 6-pin core | Uncombined | 100SR-UCX (kwy) | \$22.47 |
| | Combined ¹ | 100SR- (kwy) | \$42.02 |
| 7-pin core | Uncombined | 7100SR-UCX (kwy) | \$22.47 |
| | Combined ¹ | 7100SR- (kwy) | \$42.02 |

¹ Combined cores includes 2 operating keys and related keying charges.

Keys

| For Keyways: 1C, 1D, AB, BB, CB, DB, EB, FB, GB, HB, JB, KB, LB, MB, QB, RB, TA, TB, TC, TD, TE | Part No. | Price |
|---|----------|--------|
| Key blank | C(kwy) | \$1.29 |
| Operating key | | \$4.33 |
| Control key | | \$8.74 |

| For Keyways: WA, WB, WC, WG, WH, WY | Part No. | Price |
|-------------------------------------|----------|--------|
| Key blank | GB(kwy) | \$3.22 |
| Operating key | | \$9.68 |
| Control key | | \$9.68 |

| Stamping Charges | Price |
|--|-----------------|
| Stamping key with letters and/or numbers (limited to key space) | \$4.68 per side |
| Stamping key with <i>US Property Do Not Duplicate</i> | \$1.69 per side |
| Stamping cylinder with standard keying symbols (specify visual or concealed) | \$3.13 |

| Stamping Charges for factory systems | Specify | Price |
|---|---------|----------------|
| Stamping cylinder (visual) and 2 keys with standard keying symbols | VKC | No Add |
| Stamping cylinder (concealed) and 2 keys with standard keying symbols | CKC | No Add |
| Stamping each additional key with standard keying symbols | | \$3.13 per key |

Construction Cores & Tailpieces

| Construction Cores & Components | Part No. | 04, 26D |
|---------------------------------|------------|---------|
| 6-pin construction core | 100CR.RED | \$20.38 |
| 7-pin construction core | 7100CR.RED | \$20.38 |
| Disposable SFIC plug adapter | 13-5176 | \$0.88 |
| Construction master key | | \$8.74 |
| Construction control key | | \$8.74 |

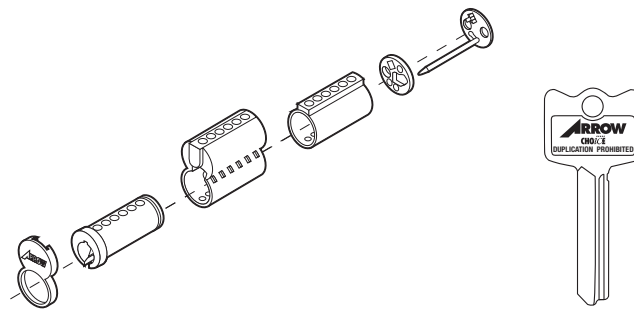

Pointe Flex SFIC Cylinders

Patented Product

| Pointe Flex SFIC Cylinders & Keys ¹ | | Part No. | 04, 26D |
|--|------------|-----------------|---------|
| 6-pin core | Uncombined | X1CR-UCX (kwy) | \$31.08 |
| | Combined | X1CR-(kwy) | \$50.25 |
| 7-pin core | Uncombined | X71CR-UCX (kwy) | \$31.08 |
| | Combined | X71CR-(kwy) | \$50.25 |
| Key blank without hole | | CH (kwy) | \$1.29 |
| Key blank with hole | | CHX (kwy) | \$4.33 |
| Operating key without hole | | | \$5.29 |
| Operating key with hole | | | \$8.74 |
| Master, grandmaster, or control key | | | \$8.74 |

¹ See Pointe SFIC page for stamping charges.

• Contact factory for Flex keyway information.

| Tailpieces & Components | Application | Part No. | Price |
|---|-----------------------------------|--------------|--------|
| IC core tailpiece pack for 6- & 7-pin cores | RL Series 6-pin IC core tailpiece | HSCR6-44 | \$3.10 |
| | RL Series 7-pin IC core tailpiece | HSCR7-44 | \$3.10 |
| | MK Series | 550CR-44-201 | \$5.03 |
| | RK Series | 100CR-44-201 | \$5.03 |
| Tailpiece for use with Falcon... | 6-pin core levers | X1CRF6-44 | \$2.58 |
| | 7-pin core levers | X71CRF7-44 | \$2.58 |
| Tailpiece for use with Best... | 6-pin core levers or knobs | X1CRB6-44 | \$2.58 |
| | 7-pin core levers or knobs | X71CRB7-44 | \$2.58 |
| Tailpiece insert for cylindrical locks – 100-piece pack | | X1CR-125PK | \$8.39 |

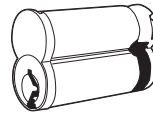

| Sliding Door Lock | Part No. | 04, 26D |
|-------------------|--------------------|---------|
| 7-Pin uncombined | SD7100CR-UCX (kwy) | \$45.90 |
| 7-Pin combined | SD7100CR- (kwy) | \$58.55 |

Cam Locks

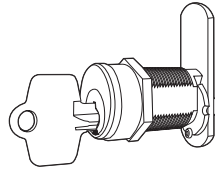

| Cam Lock Kits | Part No. | Price |
|--|---------------------------------|---------|
| Sub-Assembled | CLK-10-(kwy ¹).26D | \$58.30 |
| Keyed different or keyed alike w/2 cut keys (not master-keyed) | CLK-11-(kwy ¹).26D | \$73.85 |
| Master-keyed w/2 cut keys | CLK-11M-(kwy ¹).26D | \$86.60 |

¹ Available with standard Arrow IC keyways except for W and Flex.

| Cam Lock Parts | Part No. | Price |
|------------------------|------------------------|---------|
| Machined Plug | IKMPLG-(kwy).26D | \$11.90 |
| Shell | IKSHELL2.26D | \$19.50 |
| 4-40 Screw | IKSCRPLT | \$0.95 |
| Retainer | CP-021810 | \$0.38 |
| 90° Stop | IKSTOP2 | \$2.81 |
| 3/4" Hex Nut | IKHXNUT | \$0.35 |
| Drive Pin | IKDRPIN | \$1.61 |
| 360° Drive Plate (NKR) | IKDRPLT | \$2.86 |
| 90° Drive Plate (KR) | IKDRPLT2 | \$4.36 |
| Cam, Straight | IKCAM2 | \$3.15 |
| Cam, Offset | IKCAM3 | \$6.93 |
| Pronged Washer | IKWSH1 | \$0.79 |
| Tumbler Spring | IKTSPRING ² | \$5.25 |
| Pin Hole Cover | IKPNCVR ² | \$10.50 |

² Unit price shown. Sold in package quantities of 100.

| Cam Lock Accessories | Part No. | Price |
|---|-------------|--------|
| Spacer, 1/16" | IKSPCR1.26D | \$4.60 |
| Spacer, 1/8" | IKSPCR3.26D | \$5.30 |
| Spacer, 3/16" | IKSPCR4.26D | \$5.61 |
| Spacer, 1/4" (provided with cam lock kit) | IKSPCR5.26D | \$5.74 |
| Spacer, 5/16" | IKSPCR2.26D | \$5.80 |
| Spacer, 3/8" | IKSPCR6.26D | \$6.49 |
| Spacer, 7/16" | IKSPCR7.26D | \$6.79 |

Plus IC Housings

| Mortise Housings for Plus Cores ^{1,2} | | Specify Finish | Part No. | Price |
|--|----------|----------------|-----------------|---------|
| 6-pin housings, 1-1/8" | Standard | • | C16CR-16X (cam) | \$39.34 |
| | Tapered | • | C16CRT-16XAR18 | \$40.85 |
| 7-pin housings, 1-1/4" | Standard | • | C16CR-27X (cam) | \$39.34 |
| | Tapered | • | C16CRT-27XAR18 | \$40.85 |

| Mortise Housing Parts | Specify Finish | Part No. | Price |
|---|----------------|--------------|--------|
| Cam for mortise lock functions 12, 17, 22, 23, 24, 27, 32 (I/S), 33, 37 | | 001 | \$3.47 |
| Cam for mortise lock functions 11, 13, 19, 20, 21, 31, 32 (O/S), 34, 38, 40, 41, 42, 44 | | AM2 | \$3.47 |
| Cam for N series, panic device trims, alarms | | 004 | \$3.47 |
| Cam for Schlage locks | | 006 | \$3.47 |
| Cam for Adam Rite locks | | AR18 | \$3.47 |
| Cam assembly (unequal leg prongs) for 7-pin mortise housing | | C16CR-121A | \$8.48 |
| Cam assembly (unequal leg prongs) for 6-pin mortise housing | | C16CR-121A-1 | \$8.48 |

| Rim Housings for Plus Cores ¹ | Specify Finish | Part No. | Price |
|--|----------------|-----------|---------|
| 6-pin housing | • | C16RCR-16 | \$39.34 |
| 7-pin housing | • | C16RCR-27 | \$39.34 |

| Rim Housing Parts | Part No. | Price |
|---|---------------|--------|
| Cam bar | 16RCR-44 | \$2.60 |
| Cam assembly (unequal leg prongs) for 7-pin rim housing | C16RCR-121A | \$8.48 |
| Cam assembly (unequal leg prongs) for 6-pin rim housing | C16RCR-121A-1 | \$8.48 |
| Spring washer | 16RCR-125 | \$0.78 |
| Yoke plate | 961CR-117 | \$0.96 |
| Pan head screw (2 required) | 4-40X1/4 | \$0.44 |

| Tools & Components | Application | Part No. | Price |
|---|-------------|-----------|----------|
| IC Housing shear tool | | IC281 | \$186.00 |
| MK Series IC core tailpiece pack for 6- & 7-pin cores | | CM-44-201 | \$5.03 |
| RK Series 6-pin IC core tailpiece | | CH6-44 | \$3.10 |
| RK Series 7-pin IC core tailpiece | | CH7-44 | \$3.10 |
| RL Series 6-pin IC core tailpiece | | CL6-44 | \$3.10 |
| RL Series 7-pin IC core tailpiece | | CL7-44 | \$3.10 |

¹ Unequal leg prongs.

² Screw-on cams. Standard 001 cam supplied unless otherwise specified.

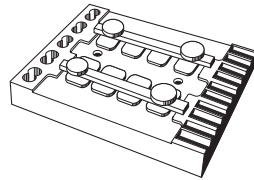

IC233 Stamping Tray



IC234 Duo Block

Cylinder Parts & Tools

| IC Tools | Part No. | Price |
|------------------------------------|----------|------------|
| Mortise cylinder installation tool | IC230 | \$50.00 |
| Stamping tray | IC233 | \$1,643.00 |
| Duo block (for capping) | IC234 | \$232.00 |
| Ejector pin (single ejector) | IC235 | \$35.00 |
| 50 Capping strips (200 cores) | IC237 | \$66.00 |

Keying Kits & Components

| For conventional cylinders | Part No. | Price | |
|---|------------------------|------------------|--------|
| Keying kit - pins, springs, slides, retainer rings, plug followers, tail pieces | 60-Key-Kit | \$228.00 | |
| | Top pins | AD142PK | \$8.01 |
| Replacement pins | Bottom pins | AB140PK to 149PK | \$8.01 |
| Note: Bulk packed 100 pcs per pack | Master pins | AM142PK to 149PK | \$8.01 |
| | Cylinder caps (strips) | 60C-111PK | \$8.01 |

| For IC cylinders | Part No. | Price | |
|---|-----------------|-------------------------|---------|
| Keying kit - pins, springs, cap gauge, pin ejector, capping pin | IC200 | \$666.00 | |
| | Bottom pins | RB100PK to 109PK | \$8.85 |
| Replacement pins & caps | Top pins | RM102PK to 119PK | \$8.85 |
| Note: Bulk packed 100 pcs per pack | Springs | 100CR-107PK | \$8.85 |
| | Barrel caps | 100CR-111PK | \$8.85 |
| Key gauge | IC205 | \$6.77 | |
| Pin ejector | IC206 | \$64.00 | |
| Replacement pin for IC206 | IC206-1 | \$10.48 | |
| Capping tool | IC207 | \$300.00 | |
| Capping pin | IC208 | \$61.00 | |
| Slide cap cover | For 6-pin cores | 100CR-130 ¹ | \$48.30 |
| | For 7-pin cores | 7100CR-130 ¹ | \$48.30 |

¹ Unit price shown. Sold in package quantities of 100.

Architectural Panic Devices

Features

| | |
|-----------------------------|---|
| Certification | BHMA A156.3, Grade 1, available UL Listed |
| Door Thickness | 1-3/4" |
| Cylinder (where applicable) | Standard: 6-pin, solid brass, 2 nickel-silver keys; IC prep available |
| Handing | Right-hand Reverse (RR) or Left-hand Reverse (LR) |
| Warranty | 5 years |

| Available Finishes | Arrow Code | BHMA Code | U.S. Code |
|--|------------|-----------|-----------|
| Bright brass | 03 | 605 | US3 |
| Satin brass | 04 | 606 | US4 |
| Satin bronze | 10 | 612 | US10 |
| Dark oxidized satin bronze, oil rubbed | 10B | 613 | US10B |
| Dark oxidized satin bronze, equivalent | 10BE | 613E | US10BE |
| Bright chromium plated | 26 | 625 | US26 |
| Satin chromium plated | 26D | 626 | US26D |
| Bright stainless steel | 32 | 629 | US32 |
| Satin stainless steel | 32D | 630 | US32D |
| Aluminum painted or powder coated | AL | 689 | - |

How to Order

| | |
|-----------------------------------|------------------------------|
| Series | 38 |
| Function | 38-88 |
| Exterior Trim & Finish (optional) | 38-88-SL-26D |
| Door Width ¹ | 38-88-SL-26D-F |
| Interior Finish (pushbar) | 38-88-SL-26D-F-32D |
| Handing | 38-88-SL-26D-F-32D-RR |

¹ F indicates a 36" wide door; E indicates a 24" door; G indicates a 48" door.



3880 Series Rim Panic Device

| Less Trim | Part No. | AL ¹ | 10, 10B, 10BE, 32D | 03, 04, 32 |
|--------------------|--------------------|-----------------|--------------------|------------|
| Exit only | 38-81 | | | |
| Classroom function | Less SL lever trim | 38-88 | | |
| | Less pull trim | 38-05 | | |
| Storeroom function | Less trim | 38-83 | \$1,132.00 | \$1,257.00 |
| Passage function | Less SL lever trim | 38-8A | | |
| | Less pull trim | 38-5A | | \$1,312.00 |

Panic Device With Trim

| | SL ² Lever Trim | 10, 10B, 10BE, 32D | 03, 04, 26, 32 |
|------------|----------------------------|--------------------|----------------|
| Classroom | 38-88-SL | \$1,724.00 | \$1,804.00 |
| Storeroom | 38-83-SL | \$1,724.00 | \$1,804.00 |
| Passage | 38-8A-SL | \$1,684.00 | \$1,764.00 |
| Dummy Trim | 38-82-SL | \$1,684.00 | \$1,764.00 |
| | SS Pull Trim | 10, 10B, 10BE, 32D | 03, 04, 26, 32 |
| Classroom | 38-05-SS | \$1,583.00 | \$1,663.00 |
| Storeroom | 38-83-SS | \$1,583.00 | \$1,663.00 |
| Passage | 38-5A-SS | \$1,543.00 | \$1,623.00 |
| Dummy Trim | 38-82-SS | \$1,543.00 | \$1,623.00 |
| | SN ² Pull Trim | 10, 10B, 10BE, 32D | 03, 04, 26, 32 |
| Classroom | 38-05-SN | \$1,542.00 | \$1,622.00 |
| Storeroom | 38-83-SN | \$1,542.00 | \$1,622.00 |
| Passage | 38-5A-SN | \$1,502.00 | \$1,582.00 |
| Dummy Trim | 38-82-SN | \$1,502.00 | \$1,582.00 |
| | SB Pull Trim | 10, 10B, 10BE, 32D | 03, 04, 26, 32 |
| Classroom | 38-05-SB | \$1,542.00 | \$1,622.00 |
| Storeroom | 38-83-SB | \$1,542.00 | \$1,622.00 |
| Passage | 38-5A-SB | \$1,502.00 | \$1,582.00 |
| Dummy Trim | 38-82-SB | \$1,502.00 | \$1,582.00 |
| | SP Pull Trim | 10, 10B, 10BE, 32D | 03, 04, 26, 32 |
| Classroom | 38-05-SP | \$1,542.00 | \$1,622.00 |
| Storeroom | 38-83-SP | \$1,542.00 | \$1,622.00 |
| Passage | 38-5A-SP | \$1,502.00 | \$1,582.00 |
| Dummy Trim | 38-82-SP | \$1,502.00 | \$1,582.00 |

Trim Only

| | SL ² Lever Trim | 10, 10B, 10BE, 26D | 03, 04, 26 |
|--|----------------------------|-------------------------|----------------|
| | SL88 | \$467.00 | \$492.00 |
| | SL83 | \$467.00 | \$492.00 |
| | SL88A | \$427.00 | \$452.00 |
| | SL02 | \$427.00 | \$452.00 |
| | SS Pull Trim | 10, 10B, 10BE, 26D, 32D | 03, 04, 26, 32 |
| | SS05 | \$326.00 | \$351.00 |
| | SS83 | \$326.00 | \$351.00 |
| | SS05A | \$286.00 | \$311.00 |
| | SS02 | \$286.00 | \$311.00 |
| | SN ² Pull Trim | 10, 10B, 10BE, 26D | 03, 04, 26 |
| | SN05 | \$285.00 | \$310.00 |
| | SN83 | \$285.00 | \$310.00 |
| | SN05A | \$245.00 | \$270.00 |
| | SN02 | \$245.00 | \$270.00 |
| | SB Pull Trim | 10, 10B, 10BE, 26D, 32D | 03, 04, 26, 32 |
| | SB05 | \$285.00 | \$310.00 |
| | SB83 | \$285.00 | \$310.00 |
| | SB05A | \$245.00 | \$270.00 |
| | SB02 | \$245.00 | \$270.00 |
| | SP Pull Trim | 10, 10B, 10BE, 26D, 32D | 03, 04, 26, 32 |
| | SP05 | \$285.00 | \$310.00 |
| | SP83 | \$285.00 | \$310.00 |
| | SP05A | \$245.00 | \$270.00 |
| | SP02 | \$245.00 | \$270.00 |

¹ AL finish applies to pushrail.

² SL and SN trims are not available in 32D or 32 finish; 26D or 26 supplied.

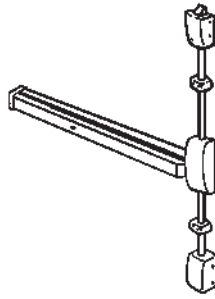

3700 Series Surface Vertical Rod Panic Device

| Less Trim | Part No. | AL ¹ | 10, 10B, 10BE, 32D | 03, 04, 32 |
|--------------------|----------------|-----------------|--------------------|------------|
| Exit only | 37-01 | | | |
| Classroom function | Less SL trim | 37-08 | | |
| | Less pull trim | 37-05 | \$1,699.00 | \$1,831.00 |
| Passage function | Less SL trim | 37-8A | | |
| | Less pull trim | 37-5A | | \$1,886.00 |

Panic Device With Trim

| | SL ² Lever Trim | 10, 10B, 10BE, 32D | 03, 04, 26, 32 |
|------------|----------------------------|--------------------|----------------|
| Classroom | 37-08-SL | \$2,298.00 | \$2,378.00 |
| Passage | 37-8A-SL | \$2,258.00 | \$2,338.00 |
| Dummy Trim | 37-02-SL | \$2,258.00 | \$2,338.00 |
| | SS Pull Trim | 10, 10B, 10BE, 32D | 03, 04, 26, 32 |
| Classroom | 37-05-SS | \$2,157.00 | \$2,237.00 |
| Passage | 37-5A-SS | \$2,117.00 | \$2,197.00 |
| Dummy Trim | 37-02-SS | \$2,117.00 | \$2,197.00 |
| | SN ² Pull Trim | 10, 10B, 10BE, 32D | 03, 04, 26, 32 |
| Classroom | 37-05-SN | \$2,116.00 | \$2,196.00 |
| Passage | 37-5A-SN | \$2,076.00 | \$2,156.00 |
| Dummy Trim | 37-02-SN | \$2,076.00 | \$2,156.00 |
| | SB Pull Trim | 10, 10B, 10BE, 32D | 03, 04, 26, 32 |
| Classroom | 37-05-SB | \$2,116.00 | \$2,196.00 |
| Passage | 37-5A-SB | \$2,076.00 | \$2,156.00 |
| Dummy Trim | 37-02-SB | \$2,076.00 | \$2,156.00 |
| | SP Pull Trim | 10, 10B, 10BE, 32D | 03, 04, 26, 32 |
| Classroom | 37-05-SP | \$2,116.00 | \$2,196.00 |
| Passage | 37-5A-SP | \$2,076.00 | \$2,156.00 |
| Dummy Trim | 37-02-SP | \$2,076.00 | \$2,156.00 |
| | Aux. Control | 10, 10B, 10BE, 32D | 03, 04, 26, 32 |
| Classroom | 37-11-S3 | \$2,184.00 | \$2,264.00 |
| Storeroom | 37-12-S3 | \$2,184.00 | \$2,264.00 |

Trim Only

| SL ² Lever Trim | 10, 10B, 10BE, 26D | 03, 04, 26 |
|----------------------------|-------------------------|----------------|
| SL08 | \$467.00 | \$492.00 |
| SL08A | \$427.00 | \$452.00 |
| SL02 | \$427.00 | \$452.00 |
| SS Pull Trim | 10, 10B, 10BE, 26D, 32D | 03, 04, 26, 32 |
| SS05 | \$326.00 | \$351.00 |
| SS05A | \$286.00 | \$311.00 |
| SS02 | \$286.00 | \$311.00 |
| SN ² Pull Trim | 10, 10B, 10BE, 26D | 03, 04, 26 |
| SN05 | \$285.00 | \$310.00 |
| SN05A | \$245.00 | \$270.00 |
| SN02 | \$245.00 | \$270.00 |
| SB Pull Trim | 10, 10B, 10BE, 26D, 32D | 03, 04, 26, 32 |
| SB05 | \$285.00 | \$310.00 |
| SB05A | \$245.00 | \$270.00 |
| SB02 | \$245.00 | \$270.00 |
| SP Pull Trim | 10, 10B, 10BE, 26D, 32D | 03, 04, 26, 32 |
| SP05 | \$285.00 | \$310.00 |
| SP05A | \$245.00 | \$270.00 |
| SP02 | \$245.00 | \$270.00 |
| Aux. Control | 10, 10B, 10BE, 26D, 32D | 03, 04, 26, 32 |
| S311 | \$353.00 | \$378.00 |
| S312 | \$353.00 | \$378.00 |

¹ AL finish applies to pushrail.

² SL and SN trims are not available in 32D or 32 finish; 26D or 26 supplied.

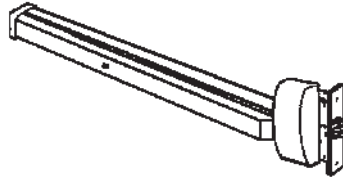

3900 Series Mortise Panic Device

| Less Trim | Part No. | AL ¹ | 10, 10B, 10BE, 32D | 03, 04, 32 |
|--------------------|--------------------|-----------------|--------------------|------------|
| Exit only | 39-01 | | | |
| Classroom function | Less SL lever trim | 39-08 | | |
| | Less pull trim | 39-05 | | |
| Storeroom function | Less trim | 39-03 | \$1,600.00 | \$1,775.00 |
| Passage function | Less SL lever trim | 39-8A | | |
| | Less pull trim | 39-5A | | \$1,830.00 |

Panic Device With Trim

| | SL ² Lever Trim | 10, 10B, 10BE, 32D | 03, 04, 26, 32 |
|------------|----------------------------|--------------------|----------------|
| Classroom | 39-08-SL | \$2,242.00 | \$2,322.00 |
| Storeroom | 39-03-SL | \$2,242.00 | \$2,322.00 |
| Passage | 39-8A-SL | \$2,202.00 | \$2,282.00 |
| Dummy Trim | 39-02-SL | \$2,202.00 | \$2,282.00 |
| | SS Pull Trim | 10, 10B, 10BE, 32D | 03, 04, 26, 32 |
| Classroom | 39-05-SS | \$2,101.00 | \$2,181.00 |
| Storeroom | 39-03-SS | \$2,101.00 | \$2,181.00 |
| Passage | 39-5A-SS | \$2,061.00 | \$2,141.00 |
| Dummy Trim | 39-02-SS | \$2,061.00 | \$2,141.00 |
| | SN ² Pull Trim | 10, 10B, 10BE, 32D | 03, 04, 26, 32 |
| Classroom | 39-05-SN | \$2,060.00 | \$2,140.00 |
| Storeroom | 39-03-SN | \$2,060.00 | \$2,140.00 |
| Passage | 39-5A-SN | \$2,020.00 | \$2,100.00 |
| Dummy Trim | 39-02-SN | \$2,020.00 | \$2,100.00 |
| | SB Pull Trim | 10, 10B, 10BE, 32D | 03, 04, 26, 32 |
| Classroom | 39-05-SB | \$2,060.00 | \$2,140.00 |
| Storeroom | 39-03-SB | \$2,060.00 | \$2,140.00 |
| Passage | 39-5A-SB | \$2,020.00 | \$2,100.00 |
| Dummy Trim | 39-02-SB | \$2,020.00 | \$2,100.00 |
| | SP Pull Trim | 10, 10B, 10BE, 32D | 03, 04, 26, 32 |
| Classroom | 39-05-SP | \$2,060.00 | \$2,140.00 |
| Storeroom | 39-03-SP | \$2,060.00 | \$2,140.00 |
| Passage | 39-5A-SP | \$2,020.00 | \$2,100.00 |
| Dummy Trim | 39-02-SP | \$2,020.00 | \$2,100.00 |

Trim Only

| | SL ² Lever Trim | 10, 10B, 10BE, 26D | 03, 04, 26 |
|--|----------------------------|-------------------------|----------------|
| | SL08 | \$467.00 | \$492.00 |
| | SL03 | \$467.00 | \$492.00 |
| | SL08A | \$427.00 | \$452.00 |
| | SL02 | \$427.00 | \$452.00 |
| | SS Pull Trim | 10, 10B, 10BE, 26D, 32D | 03, 04, 26, 32 |
| | SS05 | \$326.00 | \$351.00 |
| | SS03 | \$326.00 | \$351.00 |
| | SS05A | \$286.00 | \$311.00 |
| | SS02 | \$286.00 | \$311.00 |
| | SN ² Pull Trim | 10, 10B, 10BE, 26D | 03, 04, 26 |
| | SN05 | \$285.00 | \$310.00 |
| | SN03 | \$285.00 | \$310.00 |
| | SN05A | \$245.00 | \$270.00 |
| | SN02 | \$245.00 | \$270.00 |
| | SB Pull Trim | 10, 10B, 10BE, 26D, 32D | 03, 04, 26, 32 |
| | SB05 | \$285.00 | \$310.00 |
| | SB03 | \$285.00 | \$310.00 |
| | SB05A | \$245.00 | \$270.00 |
| | SB02 | \$245.00 | \$270.00 |
| | SP Pull Trim | 10, 10B, 10BE, 26D, 32D | 03, 04, 26, 32 |
| | SP05 | \$285.00 | \$310.00 |
| | SP03 | \$285.00 | \$310.00 |
| | SP05A | \$245.00 | \$270.00 |
| | SP02 | \$245.00 | \$270.00 |

¹ AL finish applies to pushrail.

² SL and SN trims are not available in 32D or 32 finish; 26D or 26 supplied.



4800 Series Narrow Stile Rim Panic Device

| Less Trim | Part No. | 10, 10B, 10BE, 32D | 03, 04, 32 |
|--------------------|-----------------------------|--------------------|------------|
| Exit only | 48-01 | | |
| Classroom function | Less SL lever trim 48-08 | \$1,431.00 | \$1,486.00 |
| Storeroom function | Less trim 48-03 | | |
| Passage function | Less SL lever trim 48-8A | | |

Panic Device With Trim

| | SL ¹ Lever Trim | 10, 10B, 10BE, 32D | 03, 04, 26, 32 |
|------------|----------------------------|--------------------|----------------|
| Classroom | 48-08-SL | \$1,898.00 | \$1,978.00 |
| Storeroom | 48-03-SL | \$1,898.00 | \$1,978.00 |
| Passage | 48-8A-SL | \$1,858.00 | \$1,938.00 |
| Dummy Trim | 48-02-SL | \$1,858.00 | \$1,938.00 |
| | SS Pull Trim | 10, 10B, 10BE, 32D | 03, 04, 26, 32 |
| Storeroom | 48-03-SS | \$1,757.00 | \$1,837.00 |
| Dummy Trim | 48-02-SS | \$1,717.00 | \$1,797.00 |
| | SN ¹ Pull Trim | 10, 10B, 10BE, 32D | 03, 04, 26, 32 |
| Storeroom | 48-03-SN | \$1,716.00 | \$1,796.00 |
| Dummy Trim | 48-02-SN | \$1,676.00 | \$1,756.00 |

Trim Only

| | SL ¹ Lever Trim | 10, 10B, 10BE, 26D | 03, 04, 26 |
|--|----------------------------|-------------------------|----------------|
| | SL08 | \$467.00 | \$492.00 |
| | SL03 | \$467.00 | \$492.00 |
| | SL08A | \$427.00 | \$452.00 |
| | SL02 | \$427.00 | \$452.00 |
| | SS Pull Trim | 10, 10B, 10BE, 26D, 32D | 03, 04, 26, 32 |
| | SS03 | \$326.00 | \$351.00 |
| | SS02 | \$286.00 | \$311.00 |
| | SN ¹ Pull Trim | 10, 10B, 10BE, 26D | 03, 04, 26 |
| | SN03 | \$285.00 | \$310.00 |
| | SN02 | \$245.00 | \$270.00 |

¹ SL and SN trims are not available in 32D or 32 finish; 26D or 26 supplied.

- Not available fire-rated.

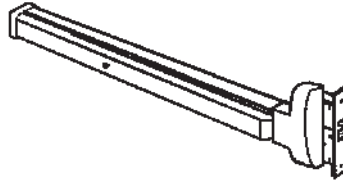

4900 Series Narrow Stile Mortise Panic Device

| Less Trim | | Part No. | 10, 10B, 10BE, 32D | 03, 04, 32 |
|--------------------|--------------------|----------|--------------------|------------|
| Exit only | | 49-01 | | |
| Classroom function | Less SL lever trim | 49-08 | \$1,612.00 | \$1,667.00 |
| Storeroom function | Less trim | 49-03 | | |
| Passage function | Less SL lever trim | 49-8A | | |

Panic Device With Trim

| | SL ¹ Lever Trim | 10, 10B, 10BE, 32D | 03, 04, 26, 32 |
|------------|----------------------------|--------------------|----------------|
| Classroom | 49-08-SL | \$2,079.00 | \$2,159.00 |
| Storeroom | 49-03-SL | \$2,079.00 | \$2,159.00 |
| Passage | 49-8A-SL | \$2,039.00 | \$2,119.00 |
| Dummy Trim | 49-02-SL | \$2,039.00 | \$2,119.00 |
| | SS Pull Trim | 10, 10B, 10BE, 32D | 03, 04, 26, 32 |
| Storeroom | 49-03-SS | \$1,938.00 | \$2,018.00 |
| Dummy Trim | 49-02-SS | \$1,898.00 | \$1,978.00 |
| | SN ¹ Pull Trim | 10, 10B, 10BE, 32D | 03, 04, 26, 32 |
| Storeroom | 49-03-SN | \$1,897.00 | \$1,977.00 |
| Dummy Trim | 49-02-SN | \$1,857.00 | \$1,937.00 |

Trim Only

| | SL ¹ Lever Trim | 10, 10B, 10BE, 26D | 03, 04, 26 |
|--|----------------------------|-------------------------|----------------|
| | SL08 | \$467.00 | \$492.00 |
| | SL03 | \$467.00 | \$492.00 |
| | SL08A | \$427.00 | \$452.00 |
| | SL02 | \$427.00 | \$452.00 |
| | SS Pull Trim | 10, 10B, 10BE, 26D, 32D | 03, 04, 26, 32 |
| | SS03 | \$326.00 | \$351.00 |
| | SS02 | \$286.00 | \$311.00 |
| | SN ¹ Pull Trim | 10, 10B, 10BE, 26D | 03, 04, 26 |
| | SN03 | \$285.00 | \$310.00 |
| | SN02 | \$245.00 | \$270.00 |

¹ SL and SN trims are not available in 32D or 32 finish; 26D or 26 supplied.

Architectural Panic Device Options

| Architectural Panic Device Options | Specify | Price | |
|---|--------------------------------|----------|----------|
| Rail Size | For 24" to 32" door widths | E | No Add |
| | For 32-1/4" to 36" door widths | F | Standard |
| | For 36-1/4" to 48" door widths | G | No Add |
| Handing | Right-hand reverse | RR | n/a |
| | Left-hand reverse | LR | n/a |
| UL Fire label (except 3700 & 4800 Series) | FR | \$175.00 | |
| UL Fire label for 3700 Series ¹ | FR | \$198.00 | |
| Cylinder dogging (includes cylinder) (not available with UL fire label devices) | CD | \$83.25 | |
| 3700 Series less bottom rod | LBR ² | No Add | |
| Fire-rated 3700 Series less bottom rod | LBR ² | \$67.30 | |
| Sliding bottom bolt for 3700 Series | SB ³ | No Add | |
| Vandal-proof lever | VP ² | \$299.00 | |
| Knurled outside lever | 103 ² | \$82.30 | |

| Keying & Cylinder Options (when ordering trim) | Specify | Price |
|--|---------|----------------------|
| Keyed different | KD | Standard |
| Master keyed | MK | \$13.00 per cylinder |
| Construction master keyed | CMK | \$8.16 per cylinder |
| Master keyed & construction master keyed | MK-CMK | \$21.16 per cylinder |
| O-Bitted | OB | No Add |
| Less cylinder | LC | -\$13.35 |
| Exit trim prepared to accept 6 or 7-pin SFIC cylinder, less core | IC | No Add |

¹ Includes thru-bolts.

² Used only with SL trim.

³ Cannot be combined with FR option.

Architectural Panic Device Electrification Options

| Architectural Panic Device Electrification Option | Voltage | Specify | Price Add ¹ |
|--|-----------|---------|------------------------|
| Fail-safe trim control without key override ² | 12V AC/DC | 177 | \$807.00 |
| | 24V AC/DC | 179 | \$807.00 |
| Fail-secure trim control without key override ² | 12V AC/DC | 181 | \$807.00 |
| | 24V AC/DC | 183 | \$807.00 |
| Fail-safe trim control with key override ³ | 12V AC/DC | 185 | \$979.00 |
| | 24V AC/DC | 186 | \$979.00 |
| Fail-secure trim control with key override ³ | 12V AC/DC | 187 | \$979.00 |
| | 24V AC/DC | 188 | \$979.00 |
| Latchbolt monitoring ⁵ | | LM | \$273.00 |
| Request to exit - authorized ⁶ | | RE | \$273.00 |
| Electric latch retraction ^{4,6} | | E6 | \$1,064.00 |
| Signal switch ^{6,7} | | E7 | \$393.00 |
| Electric dogging ⁶ | | E8 | \$841.00 |

| Power Supplies | Part No. | Price |
|---|----------|----------|
| Electric latch retraction for up to two doors | 1406 | \$664.00 |

¹ Electrification charges do not include price of panics.

² SL trim only; not available with 3900 or 4900 Series.

³ SL trim only; not available with 3700 or 4800 Series.

⁴ Cannot be combined with options: CD, LM, RE, and E7; not available in rail size E.

⁵ Not available with 4800 Series.

⁶ Not available with 488A or 4808.

⁷ Not available with 3800 Series, 3701, 3702, 375A, 3711, 3712, 488A, 4808.

- **Fail-Safe Trim Control**

Power on locks outside lever. Inside lever always free. For options 185, 186, 187, and 188, latch retracted by key when locked electronically.

- **Fail-Secure Trim Control**

Power off locks outside lever. Inside lever always free. For options 185, 186, 187, and 188, latch retracted by key when locked electronically.

- **Latchbolt Monitoring**

Full extension of the latch monitored by a SPDT switch.

- **Request to Exit — Authorized Egress**

Inside trim monitored by an SPDT switch. Switch can be used to shunt a door alarm to allow egress, signal a control console when the trim is activated, or activate a door alarm.

- **Electric Latch Retraction**

Provides a remote means of unlocking exit devices by momentary or maintained latch retraction.

- **Signal Switch**

Consists of two SPDT switches that monitor the touch bar and main latch. This feature also allows for alarm shunt via a mortise cylinder (not included) located on the tail of the exit device

- **Electric Dogging**

Simultaneously provides continuous latch retraction and dogging. When energized, first time mechanical activation of the push bar will continuously hold the latch retracted. When power is removed or interrupted, the latch bolt will extend and the push bar released.

S1150, S1250, ED910, & PEC910 Series Panic Devices

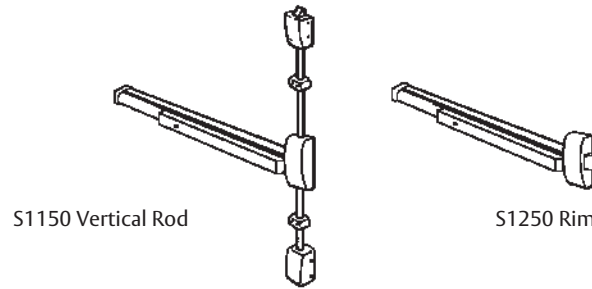

S1150/S1250 Devices Less Trim

| Standard Panic Devices for 32-1/4" to 36" Door Widths | AL, BRZ, LBZ | Price |
|---|--------------|----------|
| Surface vertical rod | S1150 | \$701.00 |
| Rim | S1250 | \$367.00 |

| Fire-Rated Panic Devices for 32-1/4" to 36" Door Widths | AL, BRZ, LBZ | Price |
|---|--------------|----------|
| Surface vertical rod | FS1150 | \$888.00 |
| Rim | FS1250 | \$532.00 |

| Panic Device Options | Add Suffix | Price Add |
|--|------------|-----------|
| Cylinder dogging | CD | \$83.25 |
| Cylinder dogging prepared to accept 6- or 7-pin SFIC cylinder (not included) | CDIC | \$83.25 |
| For 24" to 32" door widths | 24 | No Add |
| For 36-1/4" to 48" door widths | 48 | No Add |

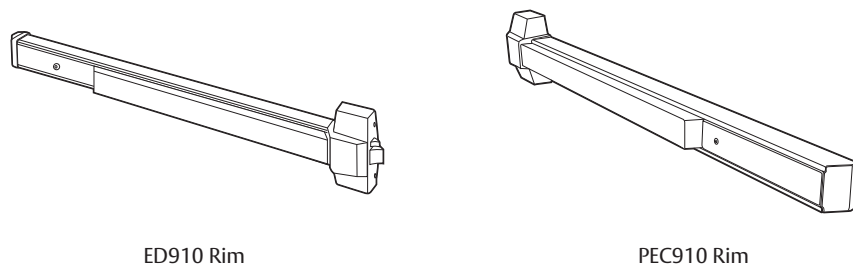

ED910/PEC910 Panic Devices

| ED910 Rim Panic Device | Part No. | 689, 613E | 630 |
|----------------------------|----------|-----------|----------|
| For 31" to 36" door widths | ED910-36 | \$234.00 | \$319.00 |
| For 43" to 48" door widths | ED910-48 | \$234.00 | \$319.00 |

| PEC910 Permanent End Cap Rim Panic Device | Part No. | 689, 613E | 630 |
|---|-----------|-----------|----------|
| For 31" to 36" door widths | PEC910-36 | \$284.00 | \$368.00 |

| Parts | Part No. | 689, 613E | 630 |
|-----------------------|-------------|-----------|---------|
| Strike | ES90 | \$23.48 | - |
| Screw pack | ES9-201 | \$12.54 | \$12.54 |
| End cap | ES9CAP | \$21.15 | \$21.15 |
| Installation Template | ES9TMPLT-36 | \$105.00 | - |

Experience a safer
and more open world

S1150, S1250, ED910, & PEC910 Series Exit Trim

Trims

| Lever Trim | | 613E, 26D | Price |
|-------------------|----------------------|-----------------------------|--------------|
| Passage | | SRX01 | \$111.00 |
| Storeroom | Standard cylinder | SRX82 | \$111.00 |
| | SFIC prep, less core | SRX82-IC | \$111.00 |
| Classroom | Standard cylinder | SRX87 | \$111.00 |
| | SFIC prep, less core | SRX87-IC | \$111.00 |
| Knob Trim | | 03, 04, 10, 10B, 26D | Price |
| Passage | | BD01 or TA01 | \$143.00 |
| Storeroom | Standard cylinder | BD12 or TA12 | \$157.00 |
| | SFIC prep, less core | TA12-IC | \$182.00 |
| Classroom | Standard cylinder | BD17 or TA17 | \$157.00 |
| | SFIC prep, less core | TA17-IC | \$182.00 |
| Plate Trim | | AL, BRZ, LBZ | Price |
| Blank Plate | | SF01 | \$63.00 |
| Dummy Pull | | SF02 | \$69.00 |
| Storeroom | Standard cylinder | SF12 | \$113.00 |
| | SFIC prep, less core | SF12-IC | \$113.00 |

Panic Device Accessories

| Accessories | | Part No. | Price |
|--|--------------------------------|----------|----------|
| Shim kit for 3880 or 3900 Series | | S59 | \$88.95 |
| Shim kit for 3700 Series | | S57 | \$107.00 |
| Shim kit for S1150 | | SH64 | \$124.00 |
| Shim kit for S1250 | | SH65 | \$101.00 |
| 18" Extension rod kit for 3700 or S1150 Series | | VRX-18 | \$101.00 |
| Dummy push rail for 3000 & 4000 Series (specify plated finish) | For 24" to 32" door widths | S3000-24 | \$385.00 |
| | For 32-1/4" to 36" door widths | S3000-36 | \$385.00 |
| | For 36-1/4" to 48" door widths | S3000-48 | \$385.00 |
| Dummy push rail for 3000 & 4000 Series (specify sprayed finish) | For 24" to 32" door widths | S3000-24 | \$308.00 |
| | For 32-1/4" to 36" door widths | S3000-36 | \$308.00 |
| | For 36-1/4" to 48" door widths | S3000-48 | \$308.00 |

Thru-Bolts

| Series | Description | Part No. | Price |
|--------|-----------------------|----------|---------|
| 3880 | Standard & fire-rated | FS54 | \$19.51 |
| | Standard | S53 | \$56.75 |
| 3700 | UL fire-rated | FS53 | \$64.80 |
| | Standard & fire-rated | FS54 | \$19.51 |
| 4800 | Standard | FS65 | \$19.51 |
| 4900 | Standard & fire-rated | FS65 | \$19.51 |
| S1150 | Standard | S51 | \$56.75 |
| | UL fire-rated | FS51 | \$64.80 |
| S1250 | Standard & fire-rated | FS52 | \$19.51 |

Panic Device Mullions

| Mullions | Part No. | Price |
|---|-------------|------------|
| Removable mullion - 96" | S20 | \$449.00 |
| Removable mullion - 120" | S20-120 | \$522.00 |
| Key removable mullion - 96", less cylinder | S20-K | \$987.00 |
| Key removable mullion - 120", less cylinder | S20L-K | \$1,034.00 |
| Removable mullion for narrow stile - 96" | S20-N | \$964.00 |
| Removable mullion for narrow stile - 120" | S20-N-120 | \$1,121.00 |
| Fire-rated removable mullion - 96" | S21 | \$602.00 |
| Fire-rated key removable mullion - 96", less cylinder | S21-K | \$1,125.00 |
| Top Retainer for S20 | S10 | \$50.20 |
| Bottom retainer for S20 | S11A | \$50.20 |
| Top retainer for S20-N | S91 | \$85.80 |
| Bottom retainer for S20-N | S92 | \$85.80 |
| Stabilizer for S20-N | S90 | \$50.20 |
| Top retainer for S21 | S88 | \$85.80 |
| Bottom retainer for S21 | S89 | \$85.80 |
| Mortise cylinder for key removable mullion | MC61-004 | \$40.12 |
| IC housing for key removable mullion | 16CR-27X004 | \$39.34 |

Panic Device Parts

| Parts | Part No. | Price | |
|--|--|----------|----------|
| SL08 spindle adapter (converts trim to SL88) | SL-386A | \$30.75 | |
| SL08 spindle adapter (required when using trim with 4800 Series) | SLS-386A | \$42.16 | |
| SL trim cover plate (covers stock hollow metal cut-out) | 38-88A | \$154.00 | |
| Mortise lockbody for 3900 or 4900 Series | Storeroom function | SL93 | \$363.00 |
| | Classroom function for thumb pull trim | SL95 | \$363.00 |
| | Passage function for thumb pull trim | SL95A | \$363.00 |
| | Classroom function for SL trim | SL98 | \$363.00 |
| | Passage function for SL trim | SL98A | \$363.00 |
| End cap for 3000 & 4000 Series | 32-7027 | \$21.15 | |
| End cap mounting bracket for 3000 & 4000 Series | 68-2141 | \$21.15 | |
| End cap for S1150 & S1250 Series | 28-0112 | \$21.15 | |
| End cap mounting bracket for S1150 & S1250 Series | 68-0080 | \$21.15 | |
| Dogging kit | 68-2596 | \$21.15 | |
| Dogging key | 97-0001 | \$9.81 | |

| Rail Assembly - S1150 & S1250 Series | Part No. | Fire Rated Part No. | AL, BRZ |
|--------------------------------------|----------|---------------------|----------|
| For 24" to 32" door widths | PR-24 | PRF-24 | \$264.00 |
| For 32-1/4" to 36" door widths | PR-36 | PRF-36 | \$264.00 |
| For 36-1/4" to 48" door widths | PR-48 | PRF-48 | \$264.00 |

| Rail Assembly - S1150 & S1250 Series w/ Cylinder Dogging | Part No. | AL, BRZ |
|--|----------|----------|
| For 24" to 32" door widths | PR-24CD | \$347.25 |
| For 32-1/4" to 36" door widths | PR-36CD | \$347.25 |
| For 36-1/4" to 48" door widths | PR-48CD | \$347.25 |

| Rail Assembly - 3000 Series | Part No. | Fire Rated Part No. | 03, 04, 10, 10B, 32, 32D |
|--------------------------------|----------|---------------------|--------------------------|
| For 24" to 32" door widths | R-24 | RF-24 | \$401.00 |
| For 32-1/4" to 36" door widths | R-36 | RF-36 | \$401.00 |
| For 36-1/4" to 48" door widths | R-48 | RF-48 | \$401.00 |

| Rail Assembly - 3000 Series w/ Cylinder Dogging | Part No. | 03, 04, 10, 10B, 32, 32D |
|---|----------|--------------------------|
| For 24" to 32" door widths | RCD-24 | \$405.25 |
| For 32-1/4" to 36" door widths | RCD-36 | \$405.25 |
| For 36-1/4" to 48" door widths | RCD-48 | \$405.25 |

| Rail Assembly - 4000 Series | Part No. | Fire Rated Part No. | 03, 04, 10, 10B, 32, 32D |
|--------------------------------|----------|---------------------|--------------------------|
| For 24" to 32" door widths | R-24-4 | RF-24-4 | \$401.00 |
| For 32-1/4" to 36" door widths | R-36-4 | RF-36-4 | \$401.00 |
| For 36-1/4" to 48" door widths | R-48-4 | RF-48-4 | \$401.00 |

| Rail Assembly - 4000 Series w/ Cylinder Dogging | Part No. | 03, 04, 10, 10B, 32, 32D |
|---|----------|--------------------------|
| For 24" to 32" door widths | RCD-24-4 | \$405.25 |
| For 32-1/4" to 36" door widths | RCD-36-4 | \$405.25 |
| For 36-1/4" to 48" door widths | RCD-48-4 | \$405.25 |

Experience a safer
and more open world

Panic Device Strikes

Strikes

| Series | Description | Part No. | Price |
|--------|-----------------------|----------|---------|
| 3880 | Standard & fire rated | S38 | \$44.30 |
| | Double door | S36 | \$44.30 |
| 3700 | Standard & fire-rated | S646 | \$48.79 |
| | Standard bottom | S23 | \$48.79 |
| | UL fire-rated bottom | S43 | \$48.79 |
| 3900 | Standard | S48C | \$28.99 |
| | Open back | S47 | \$44.30 |
| 4800 | Standard | S38 | \$44.30 |
| | Double door | S36 | \$44.30 |
| | Flush | S56 | \$44.30 |
| 4900 | Standard | S48C | \$28.99 |
| | Open back | S47 | \$44.30 |
| S1150 | Standard & fire-rated | S646 | \$48.79 |
| | Standard bottom | S23 | \$48.79 |
| | UL fire-rated bottom | S43 | \$48.79 |
| S1250 | Standard & fire rated | S38 | \$44.30 |
| | Double door | S36 | \$44.30 |

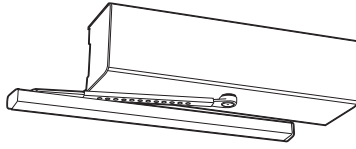

7700 Series Door Operator

Powered Door Operator

| Hinge (Pull) Side of Door | Part No. | AL, DBZ |
|---|----------|------------|
| Standard unit | 7710 | \$1,655.00 |
| Standard unit with (1) 7710SW5 wall switch | 7710K1 | \$1,863.00 |
| Standard unit with power cord | 7710P | \$1,677.00 |
| Standard unit with power cord & (1) 7710SW5 wall switch | 7710PK1 | \$1,885.00 |
| Radio frequency unit | 7710RF1 | \$1,775.00 |
| Radio frequency unit with (1) 7800T1 transmitter | 7710EX | \$1,896.00 |
| Radio frequency unit with power cord | 7710PRF1 | \$1,797.00 |
| Radio frequency unit with power cord & (1) 7800T1 transmitter | 7710PEX | \$1,918.00 |

| Stop (Push) Side of Door | Part No. | AL, DBZ |
|---|----------|------------|
| Standard unit | 7730 | \$1,655.00 |
| Standard unit with (1) 7710SW5 wall switch | 7730K1 | \$1,863.00 |
| Standard unit with power cord | 7730P | \$1,677.00 |
| Standard unit with power cord & (1) 7710SW5 wall switch | 7730PK1 | \$1,885.00 |
| Radio frequency unit | 7730RF1 | \$1,775.00 |
| Radio frequency unit with (1) 7800T1 transmitter | 7730EX | \$1,896.00 |
| Radio frequency unit with power cord | 7730PRF1 | \$1,797.00 |
| Radio frequency unit with power cord & (1) 7800T1 transmitter | 7730PEX | \$1,918.00 |

| Parts & Accessories | Part No. | Price |
|---|----------|------------|
| Door Switch - 6" sq., Stainless/Blue Letters, ADA Symbol, Radio Frequency | 7800SW2 | \$273.00 |
| Door Switch - 6" sq., Stainless/Blue Letters, ADA Symbol, Hard Wired | 7800SW3 | \$166.00 |
| Door Switch - 6" sq., Stainless/Blue Letters, Radio Frequency | 7800SW1 | \$273.00 |
| Door Switch - 6" sq., Stainless/Blue Letters, Hard Wired | 7800SW4 | \$166.00 |
| Touchless Wall Switch | 7710SW5 | \$443.00 |
| Radio Frequency (RF1) Kit | 7710RK | \$140.00 |
| Power Cord | 7710PC | \$22.00 |
| Inverter | 7710IN | \$633.00 |
| Cover | 7710COV | \$100.00 |
| Motor and Main Arm Assembly | 7710M | \$1,125.00 |
| Motor, Main Arm and Tube Assembly | 7730M | \$1,125.00 |
| Power Supply | 7710PS | \$106.00 |
| Motor Assembly | 7800MA | \$1,037.00 |
| Screw Pack | 7710SP | \$25.00 |

7800/7900 Series Door Operator

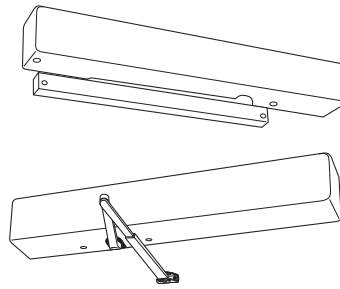

7800 Series Power Door Operators – Sizes 1-6

| Mount Application | Radio Frequency | 2 Wall Switches | Part No. | AL, DBZ |
|-------------------|-----------------|-----------------|----------|------------|
| Hinge/Pull | | | 7836H | \$3,042.00 |
| | ✓ | | 7836HR | \$3,162.00 |
| | ✓ | ✓ | 7836HRP | \$3,708.00 |
| Stop/Push | | | 7836S | \$3,042.00 |
| | ✓ | | 7836SR | \$3,162.00 |
| | ✓ | ✓ | 7836SRP | \$3,708.00 |
| Universal | | | 7836U | \$3,075.00 |
| | ✓ | | 7836UR | \$3,195.00 |

7900 Series Power Door Operators (Power Cord Version) – Sizes 1-6

| Mount Application | Radio Frequency | 2 Wall Switches | Part No. | AL, DBZ |
|-------------------|-----------------|-----------------|----------|------------|
| Hinge/Pull | | | 7936H | \$3,064.00 |
| | ✓ | | 7936HR | \$3,184.00 |
| | ✓ | ✓ | 7936HRP | \$3,730.00 |
| Stop/Push | | | 7936S | \$3,064.00 |
| | ✓ | | 7936SR | \$3,184.00 |
| | ✓ | ✓ | 7936SRP | \$3,730.00 |
| Universal | | | 7936U | \$2,097.00 |
| | ✓ | | 7936UR | \$3,217.00 |

7800/7900 Series Parts

| Parts/Accessories | Part No. | Price |
|--------------------------------------|----------|------------|
| Chain | 7800CH | \$21.00 |
| Motor Assembly | 7800MA | \$1,037.00 |
| Inverter | 7800IN | \$633.00 |
| On/Off Switch | 7800PS | \$5.90 |
| Door Position Adjustment Assembly | 7800AA | \$97.00 |
| Cover | 7800CO | \$100.00 |
| Arm & Track Assembly (Pull) | 7800TC | \$298.00 |
| Arm Assembly | 7800TA | \$105.00 |
| Track Assembly | 7800TO | \$209.00 |
| Arm Assembly (Push) | 7800SC | \$100.00 |
| Main Arm & Rod | 7800SA | \$89.00 |
| Adjusting Tube & Shoe | 7800ST | \$38.00 |
| Single Channel Hand Held Transmitter | 7800T1 | \$119.00 |
| Double Channel Hand Held Transmitter | 7800T2 | \$150.00 |
| Reed Switch | 7800RS | \$21.00 |
| RF Power Supply | 7800PWS | \$106.00 |
| Operational Signs | 7800SK9 | \$43.00 |
| Signage Kit 1 | 7800SK1 | \$7.00 |
| Signage Kit 2 | 7800SK2 | \$7.00 |
| Closer Body | 914BO | \$185.00 |

DCN300 Series

Door Closer

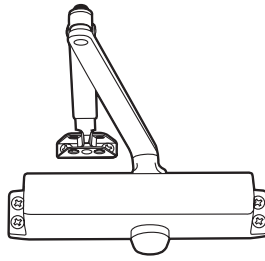

Standard Features

| ANSI/BHMA A156.4 | Sizes | Cover | Thru-Bolts |
|-------------------|-----------|-----------------|------------|
| Certified Grade 1 | 1-4 & 1-6 | Sold Separately | Included |

| Case Quantity | Average Case Weight | Warranty |
|------------------|---------------------|----------------|
| 6 (NHO) / 4 (HO) | 37 lb / 32 lbs | 5 Year Limited |

| Finishes | Arrow Code | BHMA Code |
|--------------------------------------|------------|-----------|
| Aluminum painted or powder coated | 689 | 689 |
| Dark bronze painted or powder coated | 690 | 690 |
| Black painted or powder coated* | 693* | 693* |

*Available through select distributors. Contact Arrow Lock for more information.

| DCN300 Surface Applied Door Closers | Part No. | Price |
|-------------------------------------|----------|----------|
| Size 1-4, NHO, Tri-Pack | DCN314 | \$163.00 |
| Size 1-4, HO, Tri-Pack | DCN314-1 | \$192.00 |
| Size 1-6 NHO, Tri-Pack | DCN325 | \$163.00 |
| Size 1-6, HO, Tri-Pack | DCN325-1 | \$192.00 |

| Parts & Accessories | Part No. | Price |
|--|----------|---------|
| Full Plastic Cover & 1-3/8" Thru-Bolts | DC3CVR | \$26.58 |
| Thru-Bolts 1-3/4" | DCNTB1 | \$6.77 |
| Thru-Bolts 2-1/4" | DCNTB2 | \$6.77 |

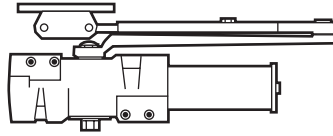

DCN500 Series Door Closer

Standard Features

| ANSI/BHMA A156.4 | Sizes | Cover | Thru-Bolts |
|-------------------|-------|----------|------------|
| Certified Grade 1 | 1-6 | Included | Included |

| Case Quantity | Average Case Weight | Warranty |
|---------------|---------------------|----------|
| 3 | 40 lbs | 10 Years |

| Finishes | Arrow Code | BHMA Code |
|--------------------------------------|------------|-----------|
| Aluminum painted or powder coated | 689 | 689 |
| Dark bronze painted or powder coated | 690 | 690 |
| Black painted or powder coated* | 693* | 693* |

*Available through select distributors. Contact Arrow Lock for more information.

| Description | Part No. | Price |
|---|----------|----------|
| Sizes 1-6, NHO, Tri-Pack | DCN516 | \$257.00 |
| Sizes 1-6, HO, Tri-Pack | DCN516-1 | \$312.00 |
| Sizes 1-6, HD, NHO, PA, Positive Stop | DCN516-2 | \$310.00 |
| Sizes 1-6, HD, HO, PA, Thumbturn, Positive Stop | DCN516-3 | \$341.00 |

| Parts & Accessories | Part No. | Price |
|--------------------------------------|-----------|----------|
| Full Plastic Cover | DCN500CV | \$25.08 |
| Drop Plate - Regular | DCN500DP | \$24.33 |
| Drop Plate - Parallel Arm | DCN500DP1 | \$26.84 |
| Drop Plate - Top Jamb | DCN500DP2 | \$24.33 |
| Drop Plate - Top Jamb, Flush Ceiling | DCN500DP3 | \$24.33 |
| Thru-bolts 1-3/4" | DCNTB1 | \$6.77 |
| Thru-bolts 2-1/4" | DCNTB2 | \$6.77 |
| Screw Pack | DCN500SP | \$10.81 |
| NHO Arm | DCN500A | \$87.85 |
| HO Arm | DCN500A1 | \$101.00 |
| HD NHO Arm | DCN500A2 | \$106.00 |
| HD HO Arm | DCN500A3 | \$119.00 |
| HD NHO Cushion Arm Kit | DCN500A4 | \$138.00 |
| HD HO Cushion Arm Kit | DCN500A5 | \$156.00 |

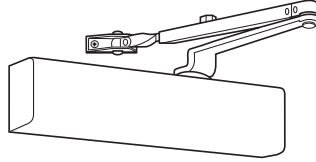

5016N Series Door Closer

| Tri-pack Models – Sizes 1-6 | Part No. | Price |
|---|----------|----------|
| Standard arm, slim plastic cover | 5016NS | \$340.00 |
| Standard arm, full plastic cover | 5016N | \$346.00 |
| Standard arm, slim plastic cover, delayed action | 5016NSD | \$376.00 |
| Standard arm, full plastic cover, delayed action | 5016ND | \$382.00 |
| Hold-open arm, slim plastic cover | 5016NSH | \$376.00 |
| Hold-open arm, full plastic cover | 5016NH | \$382.00 |
| Hold-open arm, slim plastic cover, delayed action | 5016NSHD | \$412.00 |
| Hold-open arm, full plastic cover, delayed action | 5016NHD | \$418.00 |

| Door Saver Parallel Arm Models – Sizes 1-6 | Part No. | Price |
|---|-----------|----------|
| Slim plastic cover | 5016NPS | \$382.00 |
| Full plastic cover | 5016NP | \$392.00 |
| Slim plastic cover, delayed action | 5016NPSD | \$417.00 |
| Full plastic cover, delayed action | 5016NPD | \$424.00 |
| Hold-open arm, slim plastic cover | 5016NPSH | \$427.00 |
| Hold-open arm, full plastic cover | 5016NPH | \$434.00 |
| Hold-open arm, slim plastic cover, delayed action | 5016NPSHD | \$463.00 |
| Hold-open arm, full plastic cover, delayed action | 5016NPHD | \$469.00 |

| Parts & Accessories | Part No. | Price |
|--|-----------|----------|
| Drop plate | 5016DP | \$45.42 |
| Full plastic cover | 5016FC | \$22.79 |
| Slim plastic cover | 5016SC | \$16.26 |
| 5016N Closer body | 5016BO | \$243.00 |
| 5016N Closer body with delayed action | 5016BOD | \$279.00 |
| Thru-bolts for 1-3/8" thick doors | 5016TB38 | \$10.52 |
| Thru-bolts for 1-3/4" thick doors | 5016TB34 | \$10.52 |
| Thru-bolts for 2-1/4" thick doors | 5016TB214 | \$10.52 |
| Complete (tri-pack) standard arm assembly | 5016CNA | \$77.75 |
| Complete (tri-pack) hold-open arm assembly | 5016CHA | \$114.00 |
| Door saver arm assembly, non-hold-open | 5016CDNA | \$123.00 |
| Door saver arm assembly, hold-open | 5016CDHA | \$169.00 |

- Packed 4 per case. Average case weight 16 lbs.
- Specify AL, DBZ, LBZ, GL, or BLK finish.

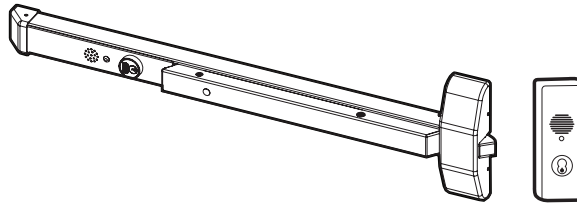

AL500

130N

AL500 & 130N Series Alarmed Hardware

| Push Bar Alarm (handed) | Part No. | 689, BSP, RD | 630 |
|-------------------------------|------------------------|--------------|------------|
| For 32-1/4" to 36" door width | AL500 | \$894.00 | \$1,082.00 |
| | AL500F (fire rated) | \$1,039.00 | \$1,227.00 |
| For 36-1/4" to 48" door width | AL500-48 | \$894.00 | \$1,082.00 |
| | AL500F-48 (fire rated) | \$1,039.00 | \$1,227.00 |

| Stand Alone Alarm | Part No. | Price |
|------------------------------------|----------|----------|
| Standard unit | 130N | \$346.00 |
| Standard unit with remote mounting | 130NXL | \$399.00 |

| AL500 Lever Trim | Description | 10B, 26D | Price |
|------------------|----------------------|----------|----------|
| Passage | | SRX01 | \$111.00 |
| | Standard cylinder | SRX82 | \$111.00 |
| Storeroom | SFIC prep, less core | SRX82-IC | \$111.00 |
| | Standard cylinder | SRX87 | \$111.00 |
| Classroom | SFIC prep, less core | SRX87-IC | \$111.00 |

| AL500 Knob Trim | Description | 03, 04, 10, 10B, 26D | Price |
|-----------------|----------------------|----------------------|----------|
| Passage | | BD01 or TA01 | \$143.00 |
| | Standard cylinder | BD12 or TA12 | \$157.00 |
| Storeroom | SFIC prep, less core | TA12-IC | \$182.00 |
| | Standard cylinder | BD17 or TA17 | \$157.00 |
| Classroom | SFIC prep, less core | TA17-IC | \$182.00 |

| AL500 Plate Trim | Description | 03, 04, 10, 10B, 26D | Price |
|------------------|----------------------|----------------------|----------|
| Passage | | PT01 | \$63.00 |
| Dummy Pull | | PT02 | \$69.00 |
| | Standard cylinder | PT03 | \$118.00 |
| Classroom | SFIC prep, less core | PT03-IC | \$118.00 |

| AL500 Parts | Part No. | Price |
|--------------------|----------|---------|
| Single door strike | S38 | \$44.30 |
| Double door strike | S36 | \$44.30 |
| Thru-bolts | F554 | \$19.51 |

Discontinued Products

ASSA ABLOY

March 16, 2020

Arrow Revolution Yale Replacement Part Numbers

| V1 Part Number (discontinued) | Replaced By Yale Part Number | Description |
|-------------------------------|------------------------------|------------------------|
| N/A | AUNTB610NR-626-100CV1-6 | NXTOUCH-PB-AU-626-ARKD |
| N/A | AUNTB610NR-626-2803-53L-6 | NXTOUCH-PB-AU-626-CSKD |
| N/A | AUNTB610NR-626-ICLC | NXTOUCH-PB-AU-626-IC |
| V151-SR-26D-V14-V44-AR-KD | AUNTB620NR-626-100CV1-6 | NXTOUCH-TS-AU-626-ARKD |
| V151-SR-26D-V14-V44-CS-KD | AUNTB620NR-626-2803-53L-6 | NXTOUCH-TS-AU-626-CSKD |
| V151-SR-26D-V14-V44-IC | AUNTB620NR-626-ICLC | NXTOUCH-TS-AU-626-IC |

| V2 Part Number (discontinued) | Replaced By Yale Part Number | Description |
|-------------------------------|------------------------------|------------------------|
| V251-10BP-V2S-V2L-CS-KD | YRD226NR-0BPSC | YRL-DB-TS-NR-US10BP-SC |
| V251-03-V2S-V2L-CS-KD | YRD226NR-605SC | YRL-DB-TS-NR-US3-SC |
| V251-15-V2S-V2L-CS-KD | YRD226NR-619SC | YRL-DB-TS-NR-US15-SC |

| V3 Part Number (discontinued) | Replaced By Yale Part Number | Description |
|-------------------------------|------------------------------|------------------------|
| V351-LR-10BP-V3S-V3L-CS-KD | YRL220NR-0BPSC | YRL-LL-TS-NR-US10BP-SC |
| V351-LR-03-V3S-V3L-CS-KD | YRL220NR-605SC | YRL-LL-TS-NR-US3-SC |
| V351-LR-15-V3S-V3L-CS-KD | YRL220NR-619SC | YRL-LL-TS-NR-US15-SC |

CONTACT CUSTOMER SERVICE FOR ADDITIONAL INFORMATION.

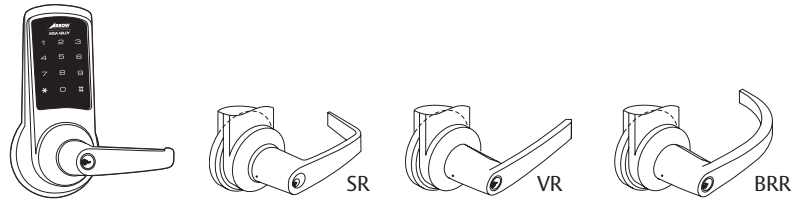

**DISCONTINUED. LIMITED AVAILABILITY THROUGH DISTRIBUTION ONLY.
CONTACT CUSTOMER SERVICE FOR ADDITIONAL INFORMATION.**

Features

| | |
|---------------------|---|
| Certification | BHMA A156.2, Series 4000, Grade 1 |
| Door Thickness | 1-3/4", kit available for 1-3/8" thick doors |
| Strike | Standard: ANSI 1-1/4" x 4-7/8"; T-strike available |
| Latch | 2-3/4" backset, 1-1/8" front |
| Cylinder | Standard: 6-pin, solid brass, 2 nickel-silver keys; IC prep available |
| Handing | Non-handed |
| Case Quantity | 3 |
| Average Case Weight | 22 lbs. |
| Warranty | 3 years |

| Available Finishes | Arrow Code | BHMA Code | U.S. Code |
|--|------------|-----------|-----------|
| Bright Brass | 03 | 605 | US3 |
| Dark Oxidized Satin Bronze, equivalent | 10BE | 613E | US10BE |
| Satin Chromium Plated | 26D | 626 | US26D |

How to Order

| | |
|----------|---------------------------|
| Function | V151 |
| Trim | V151-SR |
| Finish | V151-SR-26D |
| Strike | V151-SR-26D-V14 |
| Latch | V151-SR-26D-V14-V44 |
| Keying | V151-SR-26D-V14-V44-KD-AR |

| Strike Options | Specify |
|----------------------|---------|
| ANSI | V14 |
| T-Strike | V18 |
| ANSI with box strike | V10 |

| Latch Options | Specify |
|--------------------------------------|---------|
| 2-3/4" backset, 1-1/8" beveled front | V44 |
| 2-3/4" backset, 1-1/8" flat front | V45 |

| Keying & Cylinder Options | Specify |
|--|------------------|
| Keyed different | KD |
| Less Cylinder | LC |
| O-Bitted | OB |
| Lock prepared to accept a 6- or 7-pin SFIC cylinder (not included) | IC |
| Lock prepared to accept an LFIC Medeco or ASSA cylinder (not included) | LIC ¹ |
| Lock prepared to accept an LFIC Schlage cylinder (not included) | SIC ¹ |
| Lock prepared to accept an LFIC Corbin Russwin cylinder (not included) | CIC ¹ |

¹ Available only with SR trim.

V1 Series

Parts

**DISCONTINUED. LIMITED AVAILABILITY THROUGH DISTRIBUTION ONLY.
CONTACT CUSTOMER SERVICE FOR ADDITIONAL INFORMATION.**

| Strikes | Part No. |
|---|----------------------|
| ANSI Strike, 1-1/4" lip | V14 |
| T-Strike, 1-1/4" lip | V18 |
| Box strike | V10 |
| Latches | Part No. |
| 2-3/4" Backset, 2-1/4" x 1-1/8" beveled front | V44 |
| 2-3/4" Backset, 2-1/4" x 1-1/8" flat front | V45 |
| 2-3/4" Backset, 2-1/4" x 1" front | V35 ¹ |
| 2-3/8" Backset, 2-1/4" x 1" front | V38 ¹ |
| Cylinder & Related | Part No. |
| Standard AR cylinder with tailpiece | 100C-V1 |
| Alternate CS cylinder with tailpiece | 100CS-V1 |
| Standard keyblank | K6A |
| Tailpiece for standard cylinder | 550V1-44 |
| Parts & Accessories | Part No. |
| Inside SR lever - all functions | MS-01A-V1A |
| Outside SR lever - standard cylinder prep; less cylinder | MS-56A-V1 |
| Outside escutcheon assembly (o/s escutcheon; touchscreen assembly) | V1-ESC-OS |
| Inside escutcheon assembly (i/s escutcheon, electronics, batteries, battery cover) | V1-ESC-IS |
| 1-3/8" Thin door kit (includes I/S & O/S escutcheon spacers and a V38 ¹ latch) | V1-KIT1 |
| Motorized lock chassis | V15X-LB |
| Battery cover | V1-BCOV |
| Weather gasket kit (inside & outside gasket replacements) | V1-GSK-PK |
| Remote unlock and power wire harness | V1-RMTE |
| 5" Extension link (used only with V44 or V45 latches) | V25 x 5 ¹ |
| Pro-Lok door prep template for the Arrow V1 Series | IN490 |
| Pro-Lok universal clamp for holding door prep template | INCL |
| Trimplate pack (included 3 pairs with screws) | RP1 |
| Display mount | MOUNT-V1 |
| Lever return spring | 14-5300-1021-999 |

¹ Sold only as a separate part. Not tested to grade 1 specifications. If substituted for standard latch, grade 1 rating is voided.



V251 Touchscreen

**DISCONTINUED. LIMITED AVAILABILITY THROUGH DISTRIBUTION ONLY.
CONTACT CUSTOMER SERVICE FOR ADDITIONAL INFORMATION.**

Features

| | |
|---------------------|---|
| Certification | BHMA A156.36, Grade 2 |
| Door Thickness | Fits 1-3/8" to 2-1/4", factory set for 1-3/4" (gasket req. for 1-3/8" thick door) |
| Strike | 1-1/8" x 2-3/4", round corners |
| Latch | 2-3/8" - 2-3/4" adjustable backset, 1" front, round corners |
| Cylinder | Standard: 6-pin, solid brass, 2 brass keys; IC prep available |
| Handing | Non-handed |
| Case Quantity | 5 |
| Average Case Weight | 11 lbs. |

| Available Finishes | Arrow Code | BHMA Code | U.S. Code |
|--|------------|-----------|-----------|
| Bright Brass | 03 | 605 | US3 |
| Dark Oxidized Satin Bronze, Clear Coated | 10BP | 614 | US10BL |
| Satin Nickel | 15 | 619 | US15 |

How to Order

| | |
|----------|------------------------------|
| Function | V251 |
| Finish | V251-15 |
| Strike | V251-15-V2S |
| Latch | V251-15-V2S-V2L |
| Keying | V251-15-V2S-V2L-CS-KD |

| Options | Specify |
|---|---------|
| Strike | V2S |
| Latch | V2L |
| Keyed Different | KD |
| V251 function prepared to accept 6- or 7-pin SFIC cylinder (not included) | IC |

| Parts & Accessories | Part No. |
|--------------------------------------|------------|
| Strike | V2S |
| Latch | V2L |
| Drive-in latch ¹ | V2LD |
| Standard CS cylinder with tailpiece | 96CS-V2 |
| Alternate AR cylinder with tailpiece | 96C-V2 |
| Tailpiece for standard cylinder | V2-44 |
| Battery cover | V2-BCOV |
| V251 gasket for 1-3/8" thick door | V23-51-GSK |
| Display mount | MOUNT-V23 |

¹ Sold only as a separate part.



V3 Series



V351 Touchscreen

**DISCONTINUED. LIMITED AVAILABILITY THROUGH DISTRIBUTION ONLY.
CONTACT CUSTOMER SERVICE FOR ADDITIONAL INFORMATION.**

| Features | |
|----------------|---|
| Certification | BHMA A156.36, Grade 2 |
| Door Thickness | Fits 1-3/8" to 1-3/4", factory set for 1-3/4" |
| Strike | Full lip 1-3/8" x 2-3/4", round corners |
| Latch | 2-3/8" - 2-3/4" adjustable backset, 1" front, round corners |
| Cylinder | Standard: 5-pin, solid brass, 2 brass keys |
| Handing | Non-handed |
| Case Quantity | 5 |

| Available Finishes | Arrow Code | BHMA Code | U.S. Code |
|--|------------|-----------|-----------|
| Bright Brass | 03 | 605 | US3 |
| Dark Oxidized Satin Bronze, Clear Coated | 10BP | 614 | US10BL |
| Satin Nickel | 15 | 619 | US15 |

| How to Order | |
|-----------------|-------------------------|
| Function & Trim | V351-LR |
| Finish | V351-LR-03 |
| Strike | V351-LR-03-V3S |
| Latch | V351-LR-03-V3S-V3L |
| Keying | V351-LR-03-V3S-V3L-CSKD |

| Strike Option | Specify |
|--------------------------|---------|
| Full lip 1-3/8" x 2-3/4" | V3S |

| Latch Option | Specify |
|--|---------|
| 2-3/8" - 2-3/4" adjustable backset, 1" front | V3L |

| Keying & Cylinder Option | Specify |
|----------------------------|---------|
| Keyed different, CS keyway | CSKD |

| Parts & Accessories | Part No. |
|-----------------------------|-----------|
| Cylinder | 100C-V3 |
| Strike | V3S |
| Latch | V3L |
| Drive-in Latch ¹ | V3LD |
| Display mount | MOUNT-V23 |

¹ Sold only as a separate part.

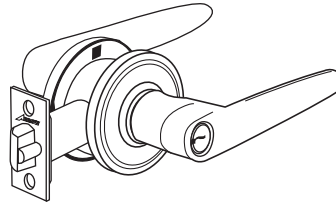

**DISCONTINUED. LIMITED AVAILABILITY THROUGH DISTRIBUTION ONLY.
CONTACT CUSTOMER SERVICE FOR ADDITIONAL INFORMATION.**

Features

| | |
|---------------------|---|
| Certification | BHMA A156.2, Series 4000, Grade 2 |
| Door Thickness | Fits 1-3/8" - 1-3/4", factory set for 1-3/4" |
| Strike | Standard: Full lip 1-5/8" x 2-1/4"; alternate strikes available |
| Latch | Standard: 2-3/8" - 2-3/4" adj. backset, 1" front; alternate latches available |
| Cylinder | 6-pin, solid brass, 2 brass keys |
| Handing | Non-handed |
| Case Quantity | 20 |
| Average Case Weight | 25 lbs |
| Warranty | 5 years |

| Available Finishes | Arrow Code | BHMA Code | U.S. Code |
|------------------------|------------|-----------|-----------|
| Bright Brass | 03 | 605 | US3 |
| Satin Brass | 04 | 606 | US4 |
| Antique Brass | 05A | 609 | US5 |
| Satin Nickel | 15 | 619 | US15 |
| Bright Chromium Plated | 26 | 625 | US26 |
| Satin Chromium Plated | 26D | 626 | US26D |

How to Order

| | |
|----------|----------------------------------|
| Function | CK11 |
| Trim | CK11-TE |
| Finish | CK11-TE-26D |
| Strike | CK11-TE-26D-502 |
| Latch | CK11-TE-26D-502-511 |
| Keying | CK11-TE-26D-502-511-KD-AR |



ASSA ABLOY

March 16, 2020

CK Series

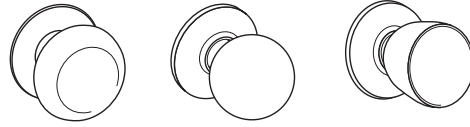

TE

BE

DE

**DISCONTINUED. LIMITED AVAILABILITY THROUGH DISTRIBUTION ONLY.
CONTACT CUSTOMER SERVICE FOR ADDITIONAL INFORMATION.**

| Function | Description | TE | BE | DE |
|----------|--------------|---------|---------|---------|
| CK01 | Passage | \$41.86 | \$39.42 | \$39.02 |
| CK02 | Privacy | \$45.14 | \$42.80 | \$42.30 |
| CK04 | Patio | \$45.14 | \$42.80 | \$42.30 |
| CK08 | Single Dummy | \$21.06 | \$19.89 | \$19.64 |
| CK11 | Entrance | \$76.94 | \$74.60 | \$74.10 |
| CK12 | Storeroom | \$76.94 | \$74.60 | \$74.10 |

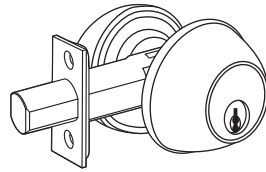

**DISCONTINUED. LIMITED AVAILABILITY THROUGH DISTRIBUTION ONLY.
CONTACT CUSTOMER SERVICE FOR ADDITIONAL INFORMATION.**

Features

| | |
|---------------------|---|
| Certification | ANSI A156.5, Grade 2, UL Listed |
| Door Thickness | Fits 1-3/8" to 1-3/4", factory set to 1-3/4" |
| Strike | 2-3/4" x 1-1/8", round corners |
| Bolt | 2-3/8" - 2-3/4" adjustable backset, 1" front, includes spacer for 1-1/8" prep |
| Cylinder | 6-pin, solid brass, keyed alike in 4, CS keyway, includes 2 brass keys |
| Handing | Non-handed |
| Case Quantity | 12 per case |
| Average Case Weight | DB61-22lbs. / DB62-27lbs. |
| Warranty | 1 year |

| Available Finishes | Arrow Code | BHMA Code | U.S. Code |
|---------------------------------------|------------|-----------|-----------|
| Bright Brass | 03 | 605 | US3 |
| Dark Oxide Satin Bronze, Clear Coated | 10BP | 614 | US10BL |
| Satin Stainless Steel | 32D | 630 | US32D |

How to Order

| | |
|----------|--------------------------------|
| Function | DB61 |
| Finish | DB61-32D |
| Strike | DB61-32D-394 |
| Latch | DB61-32D-394-157 |
| Keying | DB61-32D-394-157-KA4-CS |

| Function | Description | 32D | 03, 10B |
|----------|----------------------|---------|---------|
| DB61 | Cylinder x Thumbturn | \$42.78 | \$50.44 |
| DB62 | Double Cylinder | \$60.90 | \$68.56 |



ASSA ABLOY

March 16, 2020

900N Series

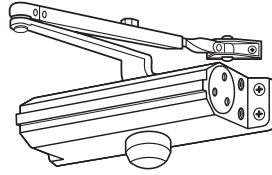

**DISCONTINUED. LIMITED AVAILABILITY THROUGH DISTRIBUTION ONLY.
CONTACT CUSTOMER SERVICE FOR ADDITIONAL INFORMATION.**

| Tri-Pack Configurations | Part No. | Price |
|--------------------------|----------|----------|
| Standard arm, sizes 1-4 | 914N | \$245.50 |
| Standard arm, sizes 3-6 | 936N | \$245.50 |
| Hold-open arm, sizes 1-4 | 914NH | \$279.74 |
| Hold-open arm, sizes 3-6 | 936NH | \$279.74 |

| Parts & Accessories | Part No. | Price |
|--|----------|----------|
| Drop plate | 936DP | \$40.52 |
| Closer body | 914BO | \$185.00 |
| Thru-bolts for 1-3/8" thick door | 5016TB38 | \$10.52 |
| Thru-bolts for 1-3/4" thick door | 5016TB34 | \$10.52 |
| Complete (tri-pack) standard arm assembly | 5016CNA | \$77.75 |
| Complete (tri-pack) hold-open arm assembly | 5016CHA | \$114.00 |

- Packed 6 per case. Average case weight 21 lbs.
- Specify AL, DBZ, LBZ, GL, or BLK finish.



ASSA ABLOY

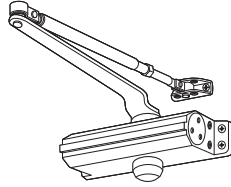

March 16, 2020

DC300 Series Door Closer

Discontinued
Products

**DISCONTINUED. LIMITED AVAILABILITY THROUGH DISTRIBUTION ONLY.
CONTACT CUSTOMER SERVICE FOR ADDITIONAL INFORMATION.**

| DC300 Surface Applied Door Closers | Part No. | Price |
|---|----------|----------|
| Size 1-4, std NHO arm, PA bracket | DC314 | \$163.00 |
| Size 1-4, std HO arm, PA bracket | DC314-1 | \$192.00 |
| Size 2-5, std NHO arm, PA bracket | DC325 | \$163.00 |
| Size 2-5, std HO arm, PA bracket | DC325-1 | \$192.00 |
| Parts & Accessories | Part No. | Price |
| Full plastic cover, screw pack, 1-3/8" thru-bolts | DC3CVR | \$26.58 |
| Thru-bolts 2" | DC500TB2 | \$6.77 |

- Packed 6 per case.
- Specify AL or DBZ finish.

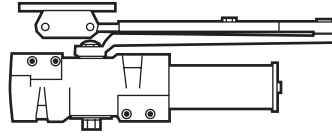

DC500 Series Door Closer

**DISCONTINUED. LIMITED AVAILABILITY THROUGH DISTRIBUTION ONLY.
CONTACT CUSTOMER SERVICE FOR ADDITIONAL INFORMATION.**

Features

| | |
|---------------------|---|
| Certification | ANSI A156.4 and ANSI ICC A117.1 Grade 1 |
| Size | 1 to 6 |
| Cover | Included: full plastic |
| Thru-Bolts | Included: 1-3/4" |
| Case Quantity | 4 |
| Average Case Weight | 51.4 lbs. |
| Warranty | 10 years |

| Description | Part No. | Price |
|--|----------|----------|
| Standard arm, non-hold open, with PA bracket | DC516 | \$257.00 |
| Standard arm, hold open, with PA bracket | DC516-1 | \$312.00 |
| Heavy-duty dead stop arm, non-hold open | DC516-2 | \$310.00 |
| Heavy-duty dead stop arm, hold open | DC516-3 | \$341.00 |

| Parts & Accessories | Part No. | Price |
|--|----------|----------|
| Full Plastic Cover | DC500CV | \$25.08 |
| Drop Plate - Regular | DC500DP | \$24.33 |
| Drop Plate - Parallel Arm | DC500DP1 | \$26.84 |
| Drop Plate - Top Jamb, Flush Ceiling | DC500DP3 | \$24.33 |
| Drop Plate - Top Jamb | DC500DP2 | \$24.33 |
| Thru-bolts 1-3/4" | DC500TB1 | \$6.77 |
| Thru-bolts 1-3/8" | DC500TB3 | \$6.77 |
| Thru-bolts 2-1/4" | DC500TB2 | \$6.77 |
| Standard Screw Pack | DC500SP2 | \$10.81 |
| Standard Non-Hold Open Arm | DC500A | \$87.85 |
| Standard Hold Open Arm | DC500A1 | \$101.00 |
| Heavy-Duty Dead Stop Arm Non-Hold Open | DC500A2 | \$106.00 |
| Heavy-Duty Dead Stop Arm Hold Open | DC500A3 | \$119.00 |
| Heavy-Duty Cushion Arm Non-Hold Open | DC500A4 | \$138.00 |
| Heavy-Duty Cushion Arm Hold Open | DC500A5 | \$156.00 |

- Specify AL or DBZ finish.

Alarmed Hardware

Discontinued Products

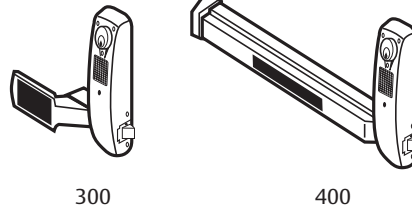

300

400

DISCONTINUED. LIMITED AVAILABILITY THROUGH DISTRIBUTION ONLY. CONTACT CUSTOMER SERVICE FOR ADDITIONAL INFORMATION.

| Alarmed Hardware | Part. No. | AL, BRZ, RD | 10,10B,26,26D |
|--------------------------|-----------|-------------|---------------|
| Paddle type | 330 | \$762.00 | \$847.00 |
| Push bar type | 430 | \$894.00 | \$1,082.00 |
| Fire-rated push bar type | F430 | \$1,039.00 | \$1,227.00 |

| Alarm Options | Specify | Price Add |
|--|---------|-----------|
| Remote monitor (wiring for remote monitor and power) | RM | \$55.00 |
| Remote power (power supply not included) | RP | \$55.00 |
| Continuous alarm | CA | \$55.00 |
| Automatic rearming | AR | \$55.00 |

- Specify LR or RR handing.
- All units designed to accept outside cylinder operation. Supplied less cylinder.
- All units include low battery alert feature.
- 300 Series packed 8 per case.
- 400 Series packed 1 per case.

| 300 & 400 Series Parts | Part No. | Price |
|--|----------|----------|
| Roller/micro switch (red & yellow wires) | 32-7044 | \$87.45 |
| On/off switch | 32-7062 | \$52.85 |
| Circuit board (specify x20 or x30) | 32-7070 | \$287.00 |
| Electronics & painted cover for x30 | 32-7035 | \$486.00 |
| Battery snap assembly | 32-7043 | \$6.02 |
| Paddle & chassis for 300 Series | 32-7065 | \$226.00 |
| Active chassis for 400 Series | 32-7171 | \$121.00 |
| End cap mounting bracket for 400 Series | 68-2141 | \$21.15 |
| End cap for 400 Series | 32-7027 | \$21.15 |
| End cap for F400 Series | 32-7080 | \$21.15 |
| Dogging key | 97-0001 | \$9.81 |
| Paddle for 300 Series | 32-1224 | \$94.00 |

The ASSA ABLOY Group is the global leader in access solutions. Every day, we help billions of people experience a more open world.

ASSA ABLOY Opening Solutions leads the development within door openings and products for access solutions in homes, businesses and institutions. Our offering includes doors, frames, door and window hardware, locks, perimeter fencing, access control and service.



ARROW USA
Phone: 1-800-839-3157
Fax: 1-800-421-6615

ARROW CANADA
Phone: 1-800-461-3007
Fax: 1-800-461-8989

Visit us at our Website:
www.arrowlock.com

For more information regarding Arrow locksets, exit devices, door closers and key systems, contact your authorized Arrow distributor.